

Programmable AC Power Source

IT-M7700 Series User Manual



Model: IT-M7700 Series
Version: V1.6/4,2022

Notices

© Itech Electronic, Co., Ltd. 2022

No part of this manual may be reproduced in any form or by any means (including electronic storage and retrieval or translation into a foreign language) without prior permission and written consent from Itech Electronic, Co., Ltd. as governed by international copyright laws.

Manual Part Number



402225

Trademarks

Pentium is U.S. registered trademarks of Intel Corporation.

Microsoft, Visual Studio, Windows and MS Windows are registered trademarks of Microsoft Corporation in the United States and/or other countries and regions.

Warranty

The materials contained in this document are provided “as is”, and is subject to change, without prior notice, in future editions. Further, to the maximum extent permitted by applicable laws, ITECH disclaims all warrants, either express or implied, with regard to this manual and any information contained herein, including but not limited to the implied warranties of merchantability and fitness for a particular purpose. ITECH shall not be held liable for errors or for incidental or indirect damages in connection with the furnishing, use or application of this document or of any information contained herein. Should ITECH and the user enter into a separate written agreement with warranty terms covering the materials in this document that conflict with these terms, the warranty terms in the separate agreement shall prevail.

Technology Licenses

The hardware and/or software described herein are furnished under a license and may be used or copied only in accordance with the terms of such license.

Restricted Rights Legend

Restricted permissions of the U.S. government. Permissions for software and technical data which are authorized to the U.S. Government only include those for custom provision to end users. ITECH follows FAR 12.211 (technical data), 12.212 (computer software). DFARS 252.227-7015 (technical data—commercial products) and DFARS 227.7202-3 (permissions for commercial computer software or computer software documents) while providing the customized business licenses of software and technical data.

Safety Notices

CAUTION

A CAUTION sign denotes a hazard. It calls attention to an operating procedure or practice that, if not correctly performed or adhered to, could result in damage to the product or loss of important data. Do not proceed beyond a CAUTION sign until the indicated conditions are fully understood and met.

WARNING

A WARNING sign denotes a hazard. It calls attention to an operating procedure or practice that, if not correctly performed or adhered to, could result in personal injury or death. Do not proceed beyond a WARNING sign until the indicated conditions are fully understood and met.



Note

A NOTE sign denotes important hint. It calls attention to tips or supplementary information that is essential for users to refer to.

Quality Certification and Assurance

We certify that series instrument meets all the published specifications at time of shipment from the factory.

Warranty

ITECH warrants that the product will be free from defects in material and workmanship under normal use for a period of one (1) year from the date of delivery (except those described in the Limitation of Warranty below).

For warranty service or repair, the product must be returned to a service center designated by ITECH.















- The product returned to ITECH for warranty service must be shipped PRE-PAID. And ITECH will pay for return of the product to customer.
- If the product is returned to ITECH for warranty service from overseas, all the freights, duties and other taxes shall be on the account of customer.

Limitation of Warranty

This Warranty will be rendered invalid in case of the following:

- Damage caused by circuit installed by customer or using customer own products or accessories;
- Modified or repaired by customer without authorization;
- Damage caused by circuit installed by customer or not operating our products under designated environment;
- The product model or serial number is altered, deleted, removed or made illegible by customer;
- Damaged as a result of accidents, including but not limited to lightning, moisture, fire, improper use or negligence.

Safety Symbols

	Direct current		ON (power)
	Alternating current		OFF (power)
	Both direct and alternating current		Power-on state
	Chassis (earth ground) symbol.		Power-off state
	Earth (ground) terminal		Reference terminal
	Caution		Positive terminal
	Warning (refer to this manual for specific Warning or Caution information)		Negative terminal
	A chassis terminal	-	-

Safety Precautions

The following safety precautions must be observed during all phases of operation of this instrument. Failure to comply with these precautions or specific warnings elsewhere in this manual will constitute a default under safety standards of design, manufacture and intended use of the instrument. ITECH assumes no liability for the customer's failure to comply with these precautions.

WARNING

- **Do not use the instrument if it is damaged. Before operation, check the casing to see whether it cracks. Do not operate the instrument in the presence of inflammable gasses, vapors or dusts.**
 - **The instrument is provided with a power cord during delivery and should be connected to a socket with a protective earth terminal, a junction box or a three-phase distribution box. Before operation, be sure that the instrument is well grounded.**
 - **Please always use the provided cable to connect the instrument.**
 - **Check all marks on the instrument before connecting the instrument to power supply.**
 - **Ensure the voltage fluctuation of mains supply is less than 10% of the working voltage range in order to reduce risks of fire and electric shock.**
 - **Do not install alternative parts on the instrument or perform any unauthorized modification.**
 - **Do not use the instrument if the detachable cover is removed or loosen.**
 - **To prevent the possibility of accidental injuries, be sure to use the power adapter supplied by the manufacturer only.**
 - **We do not accept responsibility for any direct or indirect financial damage or loss of profit that might occur when using the instrument.**
 - **This instrument is used for industrial purposes, do not apply this product to IT power supply system.**
 - **Never use the instrument with a life-support system or any other equipment subject to safety requirements.**
-

WARNING

- **SHOCK HAZARD Ground the Instrument.** This product is provided with a protective earth terminal. To minimize shock hazard, the instrument must be connected to the AC mains through a grounded power cable, with the ground wire firmly connected to an electrical ground (safety ground) at the power outlet or distribution box. Any interruption of the protective (grounding) conductor or disconnection of the protective earth terminal will cause a potential shock hazard that could result in injury or death.
 - **Before applying power, verify that all safety precautions are taken.** All connections must be made with the instrument turned off, and must be performed by qualified personnel who are aware of the hazards involved. Improper actions can cause fatal injury as well as equipment damage.
 - **SHOCK HAZARD, LETHAL VOLTAGES** This product can output the dangerous voltage that can cause personal injury, and the operator must always be protected from electric shock. Ensure that the output electrodes are either insulated or covered using the safety covers provided, so that no accidental contact with lethal voltages can occur.
 - **Never touch cables or connections immediately after turning off the instrument.** Verify that there is no dangerous voltage on the electrodes or sense terminals before touching them.
 - **After using the device, turn off the power switch of the device before unplugging the power cord or disassembling the terminals.** Do not touch the cable or the terminal immediately. Depending on the model, the dangerous voltage at the plug or terminal is maintained for 10 seconds after the device is switched off. Make sure that there is no dangerous voltage before touching them.
-

CAUTION

- **Failure to use the instrument as directed by the manufacturer may render its protective features void.**
 - **Always clean the casing with a dry cloth. Do not clean the internals.**
 - **Make sure the vent hole is always unblocked.**
-

Environmental Conditions





The instrument is designed for indoor use and an area with low condensation. The table below shows the general environmental requirements for the instrument.

Environmental Conditions	Requirements
Operating temperature	0°C ~ 40°C
Operating humidity	20% ~ 80% (non-condensation)
Storage temperature	-20°C ~ 70°C
Altitude	Operating up to 2,000 meters
Installation category	II
Pollution degree	Pollution degree 2



Note

In order to ensure the accuracy of measurement, it is recommended to operate the instrument half an hour after start-up.

Regulation Tag

	<p>The CE tag shows that the product complies with the provisions of all relevant European laws (if the year is shown, it indicates that the year when the design is approved).</p>
	<p>The UKCA tag shows that the product complies with the provisions of all relevant United Kingdom laws (if the year is shown, it indicates that the year when the design is approved).</p>
	<p>This instrument complies with the WEEE directive (2002/96/EC) tag requirements. This attached product tag shows that the electrical/electronic product cannot be discarded in household waste.</p>
	<p>This symbol indicates that no danger will happen or toxic substances will not leak or cause damage in normal use within the specified period. The service life of the product is 10 years. The product can be used safely within the environmental protection period; otherwise, the product should be put into the recycling system.</p>

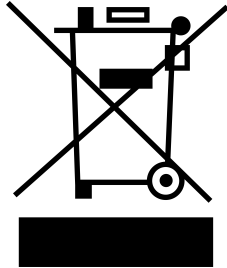
Waste Electrical and Electronic Equipment (WEEE) Directive



Waste electrical and electronic equipment (WEEE) directive, 2002/96/EC

The product complies with tag requirements of the WEEE directive (2002/96/EC). This tag indicates that the electronic equipment cannot be disposed of as ordinary household waste. Product Category

According to the equipment classification in Annex I of the WEEE directive, this instrument belongs to the "Monitoring" product.

If you want to return the unnecessary instrument, please contact the nearest sales office of ITECH.

Compliance Information

Complies with the essential requirements of the following applicable European Directives, and carries the CE marking accordingly:

- Electromagnetic Compatibility (EMC) Directive 2014/30/EU
- Low-Voltage Directive (Safety) 2014/35/EU

Conforms with the following product standards:

EMC Standard

IEC 61326-1:2012/ EN 61326-1:2013 ¹²³

Reference Standards

CISPR 11:2015+A1:2016 Ed 6.1

IEC 61000-3-2: 2018 RLV

IEC 61000-3-3: 2013+A1:2017

IEC 61000-4-2:2008

IEC 61000-4-3 2006+A1:2007+A2:2010/ EN 61000-4-3 A1:2008+A2:2010

IEC 61000-4-4:2012

IEC 61000-4-5:2014+A1:2017

IEC 61000-4-6:2013+cor1:2015

IEC 61000-4-11:2004+A1:2017

1. The product is intended for use in non-residential/non-domestic environments. Use of the product in residential/domestic environments may cause electromagnetic interference.
2. Connection of the instrument to a test object may produce radiations beyond the specified limit.
3. Use high-performance shielded interface cable to ensure conformity with the EMC standards listed above.

Safety Standard

IEC 61010-1:2010+A1:2016

Content

Quality Certification and Assurance	I
Warranty	I
Limitation of Warranty	I
Safety Symbols	II
Safety Precautions	II
Environmental Conditions	IV
Regulation Tag	V
Waste Electrical and Electronic Equipment (WEEE) Directive	VI
Compliance Information	VII
1 Quick Reference	1
1.1 Brief Introduction	1
1.2 Front Panel at a Glance	2
1.3 Front Panel Keys at a Glance	4
1.4 Rear Panel at a Glance	6
1.5 Front Panel Display at a Glance	8
1.6 Configuration Menu at a Glance	10
1.7 System Menu at a Glance	13
1.8 Optional Accessories	17
2 Inspection and Installation	20
2.1 Verifying the Shipment	20
2.2 Instrument Size Introduction	21
2.3 Connecting the Power Cord	23
2.4 Connecting the Device Under Test (DUT)	26
2.5 Connecting the Interface	29
2.5.1 USB Interface	30
2.5.2 GPIB Interface	31
2.5.3 LAN Interface	32
2.5.4 RS-232 Interface	37
2.5.5 CAN Interface	39
3 Getting Started	42
3.1 Power-on the Instrument	42
3.2 Applying DC Output	44
3.3 Applying Waveform Output	45
4 Operation and Application	48
4.1 Select the Output Mode	48
4.2 Setting the Voltage Output Range	49
4.3 Set the AC Output	50
4.3.1 Set the AC Voltage	50
4.3.2 Set the AC Frequency	51
4.3.3 Set the AC Phase Angle	51
4.3.4 Select the Output Waveform	52
4.4 Set the DC Output	53
4.4.1 Set the DC Voltage	53
4.4.2 Set the DC Voltage Rise Time	53
4.5 Set the Over-current Protection Point	54
4.6 Turning the Output On and Off	55
4.7 Step or Continue Output	55
4.8 Executing Measurement	56
4.8.1 Measurement Functions	57
4.9 Function Operation	58
4.9.1 Function Menu at a Glance	58
4.9.2 List Function	61
4.9.3 Dimmer Function	63
4.9.4 Surge/Trap Function	64
4.9.5 Digital I/O Function	66

4.9.6	Set the Output Timer Function	70
4.10	Protection Function	70
4.10.1	Set the Over-Voltage Protection (rms)	70
4.10.2	Set the Over-Voltage Protection (peak)	71
4.10.3	Set the Under-Voltage Protection (rms)	72
4.10.4	Set the Over-Current Protection (rms)	72
4.10.5	Set the Over-Current Protection (peak)	74
4.10.6	Set the Over-Power Protection	75
4.10.7	Set the Current Limiting Protection	75
4.10.8	Set the Sense Check Protection	76
4.10.9	Limiting the Setting Value Range	77
4.11	System-Related Operations	78
4.11.1	Switch Local/Remote Mode	78
4.11.2	Save and Recall Operations	78
4.11.3	Key Lock Function	79
4.11.4	Set the Beeper Status	79
4.11.5	Set the Power-on State	79
4.11.6	Restore the as-shipped settings	80
4.11.7	View the System Information	84
4.11.8	Set the Relay Control	85
4.12	External Analog Quantity Function (Option)	86
4.12.1	Definition of Analog Interface	86
4.12.2	Enable/Disable Analog Control	88
4.12.3	Analog Quantity Control	89
4.12.4	Calibrate external voltage control	93
5	Multi-units operation	95
5.1	Series Operation	95
5.2	Three-phase Operation	98
5.3	Multi-Channel Function	102
6	Routine Maintenance	105
6.1	Instrument Self-Test	105
6.2	Cleaning and Maintenance	105
6.3	Prompt Information Reference	106
6.4	Contact of ITECH Engineers	107
6.5	Return for Repair	109
7	Technical Specification	110
7.1	IT-M7721	110
7.2	IT-M7721L	112
7.3	IT-M7722	114
7.4	IT-M7722L	116
7.5	IT-M7723	118
7.6	IT-M7723E	121
A	Appendix	124
A.1	Specifications of Red and Black Test Cables	124
A.2	Built -in Waveforms	125

1 Quick Reference

This chapter briefly introduces the front panel, rear panel, keyboard button functions and front panel display functions of this series instrument to ensure a quick understanding of the appearance, structure and key usage features of the instrument before operating the instrument. This chapter does not introduce each operating characteristic in detail. It is just a quick reference guide to help you quickly learn the operating characteristics of the instrument.

- ◆ [Brief Introduction](#)
- ◆ [Front Panel at a Glance](#)
- ◆ [Front Panel Keys at a Glance](#)
- ◆ [Rear Panel at a Glance](#)
- ◆ [Front Panel Display at a Glance](#)
- ◆ [Configuration Menu at a Glance](#)
- ◆ [System Menu at a Glance](#)
- ◆ [Optional Accessories](#)

1.1 Brief Introduction

ITECH newly-launched IT-M7700 High Performance Programmable AC Power Supply combines intelligence and flexibility, breaks through the huge defects of the traditional AC power source, reduces the size to only 1/2 1U, maximizes space utilization. Built-in power meter and arbitrary waveform generator make it convenient to simulate various arbitrary waveform outputs. IT-M7700 is designed with advanced technologies of programmable AC and DC power supplies, and can be widely used in multiple fields such as power energy products, home appliances, industrial electronics and IEC standards testing.

Features:

- 1/2 1U compact design, increased space utilization
- AC, DC, AC + DC output modes, DC voltage offset simulation in AC + DC mode
- Built-in AC power meter with powerful functions
- Built-in abundant waveform database, including 30 harmonic distortion waveforms *1
- List mode, simulate civil AC working condition, realize instantaneous power interruption simulation function *1*2
- Arbitrary waveform output function, user can customize waveforms *1
- Harmonic analysis function *1
- Harmonic simulation function *1

- Surge/Trap function *1
- Front and rear edge Dimmer phase dimming function Settable output waveform start/stop phase angle *1
- Settable output waveform start/stop phase angle
- Higher voltage available by two units in series connection *1*3
- Three phase output available by three units Y-type external connections *1*3
- Optional interfaces include RS232, CAN, LAN, GPIB, USB_TMC, USB_VCP, external analog, IO. Flexible and cost effective
- With professional software, set up programs comply with multinational security regulations and test conditions, to complete IEC related standards testing *1*4

Note

- *1 IT-M7721L/IT-M7722L do not support this function.
- *2 Realize by PC software.
- *3 IT-M7723 do not support this function.
- *4 Coming soon

Model Selection Table for IT-M7700 Series:

Model	Power(AC/DC)	Voltage	Current	Frequency	Height
IT-M7721	300 VA/300 W	300 V	3 A	45~1000 Hz	1U half-rack
IT-M7721L	300 VA/300 W	300 V	3 A	45~100 Hz	1U half-rack
IT-M7722	600 VA/600 W	300 V	6A	45~1000 Hz	1U half-rack
IT-M7722L	600 VA/600 W	300 V	6A	45~100 Hz	1U half-rack
IT-M7723	1200VA/ 1200W	300V/600V	12A/6A	45~1000 Hz	1U
IT-M7723E	1500VA/ 1500W	300V	15A	45~1000 Hz	2U half-rack



Note

For detailed technical specifications, please refer to [7 Technical Specification](#).

1.2 Front Panel at a Glance

The front panel of this series instruments is shown below.

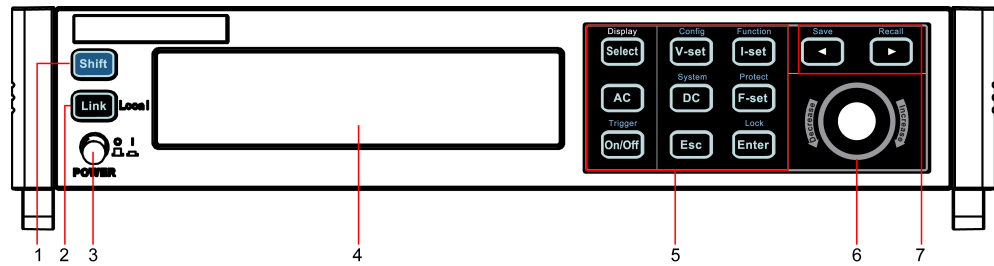
- IT-M7721/IT-M7722/IT-M7721L/IT-M7722L front panel



- IT-M7723 front panel

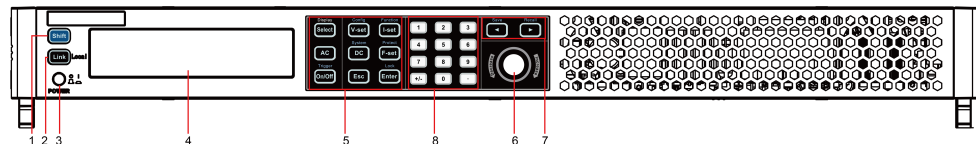

- IT-M7723E front panel

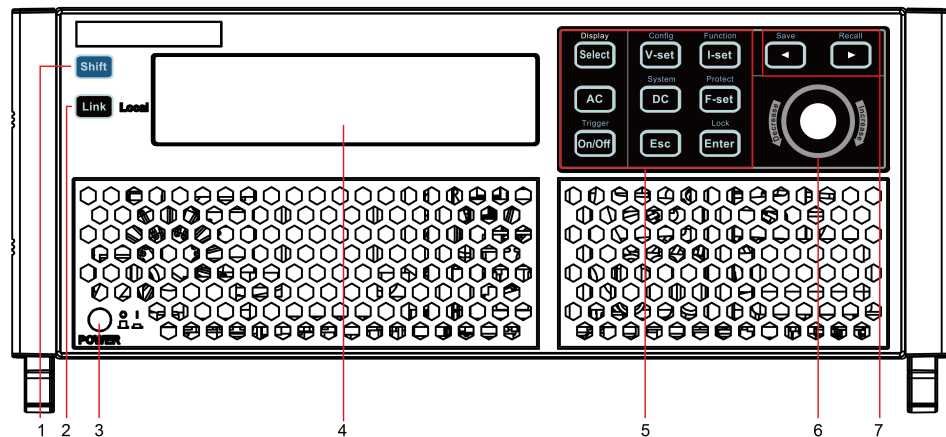

No.	Name	Description
1	[Shift]key	Composite key, combined with other keys to realize functions marked above keys.
2	[Link](Local) key	The functions is described as follows. <ul style="list-style-type: none"> [Link] key. When the instrument is connected to the PC through the LAN interface, this key will light up. Local switch key. In remote control, press [Shift] + [Link] (Local) keys to switch the instrument to local control mode.
3	Power switch	Turns the instrument on or off.
4	Vacuum fluorescent display	Displays all instrument functions. The information changes based on selected function.

No.	Name	Description
5	Function keys group	Please refer to 1.3 Front Panel Keys at a Glance for detailed description about the function keys.
6	Push button rotary	The functions is described as follows. <ul style="list-style-type: none"> • Rotate the push button rotary to adjust the value setting or scroll pages to view menu items. Rotate the push button rotary clockwise to increase the set value and anticlockwise to decrease the set value • Pressing the push button rotary acts like pressing [Enter] key to confirm an operation.
7	The left/right navigation keys and composite keys	The functions is described as follows. <ul style="list-style-type: none"> • The left and right navigation keys are used to adjust the cursor to the specified position or scrolls pages to view menu items. • Save/Recall the present settings.
8	Numeric keys	The Numeric entry keys do the following. <ul style="list-style-type: none"> • The 0 through 9 keys enter numbers. • The (.) key is the decimal point. • The ± key is used to enter a positive or negative signs.

1.3 Front Panel Keys at a Glance

The keys introduction of IT-M7700 series power source is shown as follows.

- IT-M7721/IT-M7722/IT-M7721L/IT-M7722L/IT-M7723E keys

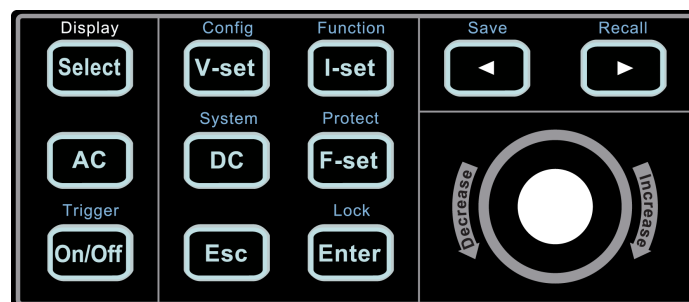

- IT-M7723 keys

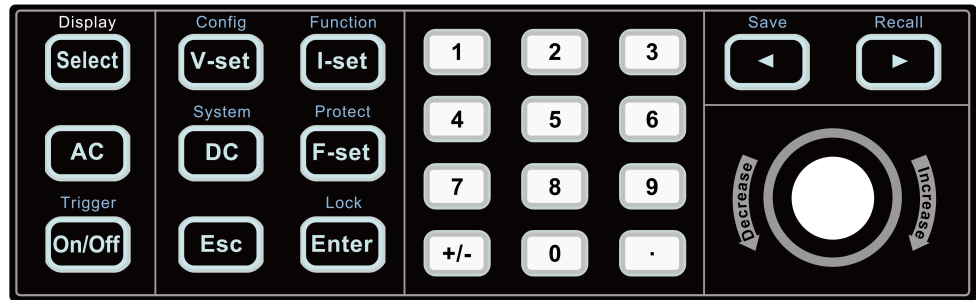



Table 1–1 Keys Description



Key Name	Description
[Select]	<ul style="list-style-type: none"> AC Mode: Switches the AC main interface. Use this key to switch the AC main interface 1 and AC main interface 2. DC Mode: [Select] key is not available.
[V-set]	Sets the output voltage value.
[I-set]	Sets the OCP _{rms} value.
[AC]	Press the [AC] key to set the instrument to AC output mode.
[DC]	Press the [DC] key to set the instrument to DC output mode.
[F-set]	<ul style="list-style-type: none"> AC Mode: Sets the frequency value. DC Mode: [F-set] key is not available.
[On/Off]	Turns the instrument output on or off. When lit, indicates that the output is on.
[Esc]	Press this key to exit the current operation interface.
[Enter]	Selects the menu item or confirm an operation.
[0]-[9]	Numeric keys.
+/-	Positive and negative signs.
.	Decimal point.
	The left and right navigation keys are used to adjust the cursor to the specified position or scrolls pages to view menu items.

Note

Display is only used to prompt that the **[Select]** key is the display switch key of the AC main interface, and has no other functions.

Composite key **[Shift]**, combined with other keys to realize functions marked above keys. The detailed functions are listed as follows.

Table 1–2 Composite keys Description

Key Name	Description
[Shift]+[V-set] (Config)	Enter the Config menu.
[Shift]+[I-set] (Function)	Enter the Function menu.
[Shift]+[DC] (System)	Enter the System menu.
[Shift]+[F-set] (Protect)	Enter the Protect menu.
[Shift]+[On/Off] (Trigger)	Generate a local trigger signal.
[Shift]+[Enter] (lock)	Turn the keyboard lock on or off.
[Shift]+  (Save)	Saves the present settings.
[Shift]+  (Recall)	Returns the instrument to the specified setup.

1.4 Rear Panel at a Glance

The rear panel of this series instruments is shown below.

- IT-M7721/IT-M7722/IT-M7721L/IT-M7722L rear panel

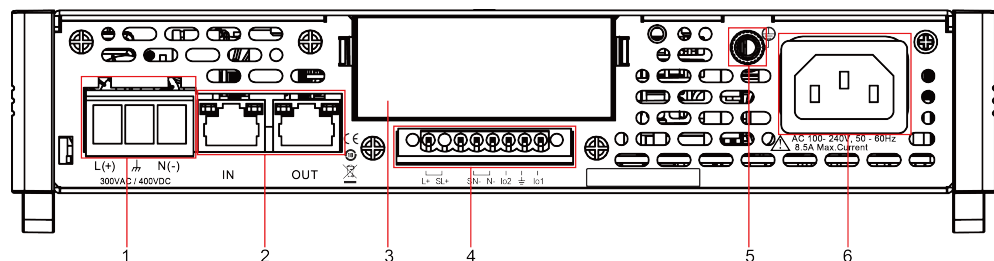

- IT-M7723 rear panel

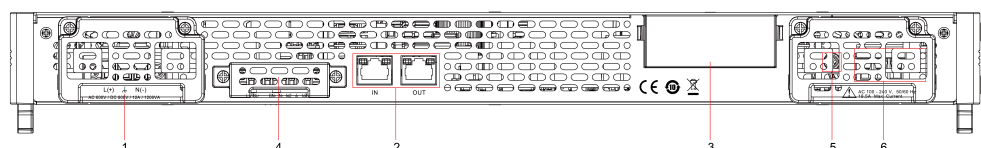

- IT-M7723E rear panel

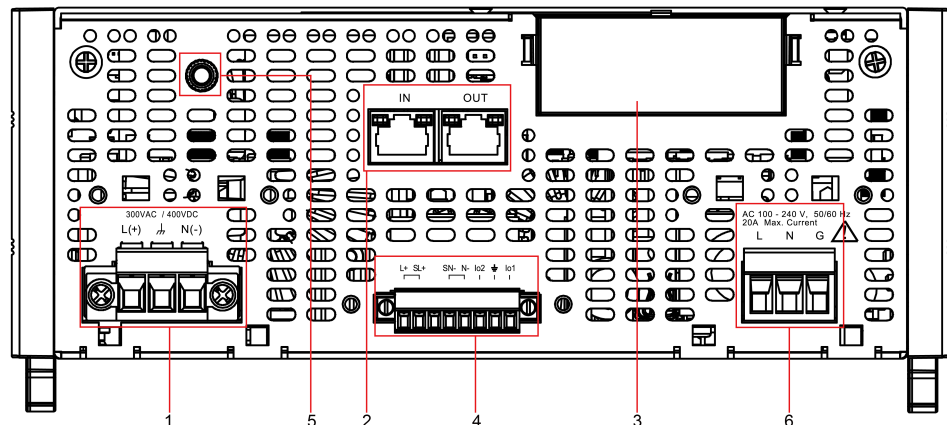

No.	Name	Description
1	Output terminals	AC or DC output terminals and chassis ground terminals, used to connect DUT.
2	System bus interfaces	Used for communication between instruments in three phase or series operation feature.
3	Extended optional interface	Optional interfaces: (Plastic plugs are inserted by default when the user does not purchase the interface.) <ul style="list-style-type: none"> • USB and LAN interfaces; • GPIB interface; • RS-232 and CAN interfaces; • Analog interface.
4	Remote sense terminals, Output lock terminals and I/O terminals	The descriptions of each terminals are as follows. <ul style="list-style-type: none"> • SL+ and SN- are remote sense terminals, used for maximizing measurement accuracy. • L+ and N- are output terminals. These two terminals are not suitable for transmitting large current. Therefore, they cannot be connected to the DUT, which are only used for short circuit during local measurement. • I/O function, please refer to 4.9.5 Digital I/O Function.

No.	Name	Description
5	Ground screw	Ground screw for making chassis ground connections.
6	AC power input socket	Used to connect AC power to start instrument, supports 100 V to 240 V.

1.5 Front Panel Display at a Glance

The IT-M7700 series power supply has different display information under the AC mode and the DC mode. Details are as follows.

- Under the AC mode, the AC main interface 1 is displayed as follows:

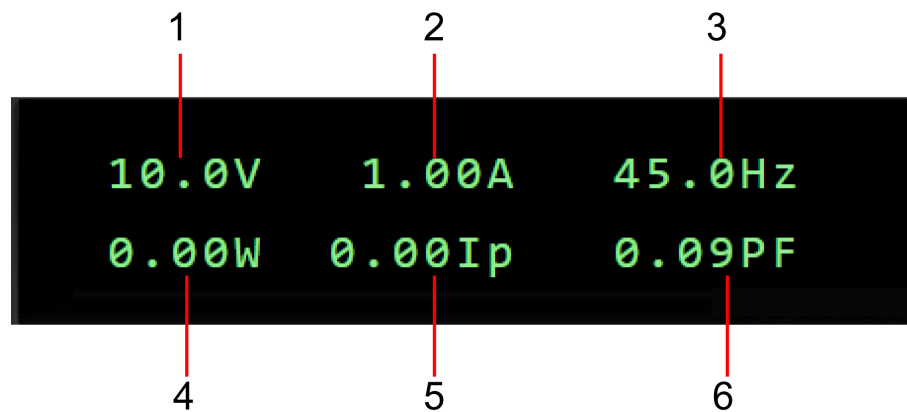

No.	Name	Description
1	Vac set value /Vrms meter value	<ul style="list-style-type: none"> • When output is Off, the AC voltage setting value is displayed. • When output is On, the Meter value of voltage effective value is displayed.
2	OCPrms set value /Irms meter value	<ul style="list-style-type: none"> • When output is Off, the OCPrms setting value is displayed. • When output is On, the Meter value of current effective value is displayed.
3	Freq set value /Freq meter value	<ul style="list-style-type: none"> • When output is Off, the frequency setting value is displayed. • When output is On, the Meter value of frequency value is displayed.
4	P meter value	Displays the Meter value of the active power.

No.	Name	Description
5	Ip meter value	Displays the Meter value of the maximum current peak value.
6	PF meter value	Displays the Meter value of the power factor.

- Under the AC mode, the AC main interface 2 is displayed as follows:

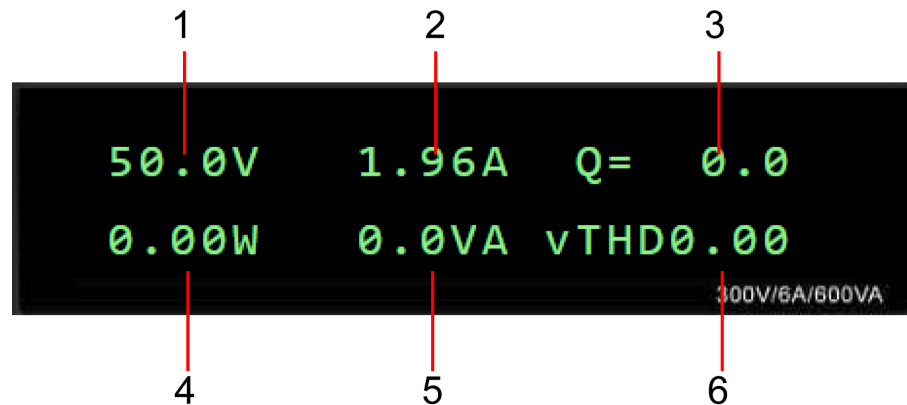

No.	Name	Description
1	Vac set value /Vrms meter value	<ul style="list-style-type: none"> • When output is Off, the AC voltage setting value is displayed. • When output is On, the Meter value of voltage effective value is displayed.
2	OCPrms set value /Irms meter value	<ul style="list-style-type: none"> • When output is Off, the OCPrms setting value is displayed. • When output is On, the Meter value of current effective value is displayed.
3	Q meter value	Displays the Meter value of the reactive power.
4	P meter value	Displays the Meter value of the active power.
5	S meter value	Displays the Meter value of the apparent power.
6	vTHD meter value	Displays the Meter value of the total voltage harmonic distortion.
	iTHD meter value	Displays the Meter value of the total current harmonic distortion.

 **Note**

- Press the **[Select]** key to switch the AC main interface 1 and AC main interface 2. When the AC main interface 1 is displayed, the **[Select]** key will not light up; when the AC main interface 2 is displayed, the **[Select]** key will light up. In the AC main interface 2, press the **[Select]** key to switch the display among vTHD and iTHD, and press the **[Select]** key again to switch back to AC main interface 1.
- IT-M7721L/IT-M7722L does not support displaying vTHD and iTHD.
- **Under the DC mode, the DC main interface is displayed as follows:**

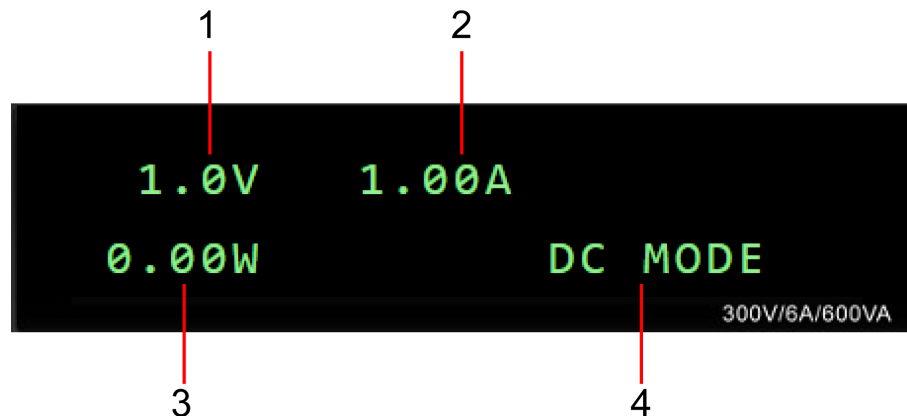

No.	Name	Description
1	Vdc set value /Vdc meter value	<ul style="list-style-type: none"> • When output is Off, the DC voltage setting value is displayed. • When output is On, the Meter value of DC voltage value is displayed.
2	OCPrms set value /Idc meter value	<ul style="list-style-type: none"> • When output is Off, the OCPrms setting value is displayed. • When output is On, the Meter value of DC voltage value is displayed.
3	P meter value	Displays the Meter value of the power.
4	OUT Mode	Displays the output mode of the instrument.

1.6 Configuration Menu at a Glance

Press the composite keys **[Shift]+[V-set]**(Config) to enter into the Config menu interface. At this time, the screen displays the optional menu. Click Rotary to page up or page down the menu. Press the **[Enter]** key to enter into the selected menu item. Press the **[Esc]** key to exit the menu function.

When the number before the menu item is in a flashing status (the digit is flashing while the colon is not flashing), it indicates that this item is the selected menu. The descriptions of configuration menu are listed in the table below.

Table 1–3 IT-M7721/IT-M7722/IT-M7723E menu

Config	Configuration menu	
	I Range	Set the current measurement range.
		High High range(Applicable frequency range: 45Hz ~ 1000Hz)
		Low Low range(Applicable frequency range: 45Hz ~ 100Hz)
		Auto Auto range. The range is automatically switched between High and Low based on the measured current. (Applicable frequency range: 45Hz ~ 100Hz)
	AC + DC	Set the AC + DC output mode.
		Off Turn off AC + DC output mode.
		On Turn on AC + DC output mode.
	On Phase	Set the starting phase angle of the waveform. (only displayed under the AC Mode)
	Off Phase	Set the ending phase angle of the waveform. (only displayed under the AC Mode)
	V-Rise Time	Set the voltage rising time. (only displayed under the DC Mode)
	Wave	Set the output waveform type. (only displayed under the AC Mode)
		Sine Sinusoidal
		Square Square
		Triangle Triangle
		Saw Sawtooth
		Clip Sine Clipped Sinusoidal
		Clip Level Clipped Percentage
		THD1~THD30 30 sets of built-in waveforms.
		USER1~USER5 5 sets of user-defined waveforms.
	Parallel	Set the instruments to 3-phase or series operation mode.
		Single Set the instrument to single mode, i.e., disable the 3-phase or series operation mode.

		600V/1A	Set the instruments to series operation mode.
		3 Phase	Set the instruments to 3-phase operation mode.

Table 1–4 IT-M7721L/IT-M7722L menu

Config	Configuration menu		
	AC + DC	Set the AC + DC output mode.	
		Off	Turn off AC + DC output mode.
		On	Turn on AC + DC output mode.
	On Phase	Set the starting phase angle of the waveform. (only displayed under the AC Mode)	
	Off Phase	Set the ending phase angle of the waveform. (only displayed under the AC Mode)	
	V-Rise Time	Set the voltage rising time. (only displayed under the DC Mode)	

Table 1–5 IT-M7723 menu

Config	Configuration menu		
	V Range	Set the voltage measurement range.	
		High	High range
		Low	Low range
	AC + DC	Set the AC + DC output mode.	
		Off	Turn off AC + DC output mode.
		On	Turn on AC + DC output mode.
	On Phase	Set the starting phase angle of the waveform. (only displayed under the AC Mode)	
	Off Phase	Set the ending phase angle of the waveform. (only displayed under the AC Mode)	
	V-Rise Time	Set the voltage rising time. (only displayed under the DC Mode)	
	Wave	Set the output waveform type. (only displayed under the AC Mode)	
		Sine	Sinusoidal
		Square	Square
		Triangle	Triangle

		Saw	Sawtooth	
		Clip Sine	Clipped Sinusoidal	
			Clip Level	Clipped Percentage
		THD1~THD30	30 sets of built-in waveforms.	
		USER1~USER5	5 sets of user-defined waveforms.	
	Channel Number	Set the channel number. Channel Number=1(1-126), the corresponding channel number is displayed in the left of the main interface during multi-channel operation.		

1.7 System Menu at a Glance

Press the composite keys **[Shift]+[DC]**(System) to enter into the System menu interface. At this time, the screen displays the optional menu. Click Rotary to page up or page down the menu. Press the **[Enter]** key to enter into the selected menu item. Press the **[Esc]** key to exit the menu function.

The descriptions of system menu are listed in the table below.

System	System menu.		
	Beep	Set the beeper status.	
		Off	Turn the beeper off.
		On	Turn the beeper on.
	PowerOn	Set the power-on state.	
		Reset	When the power source is powered on, the power source will initialize some settings and output state.
		Last	When the power source is powered on, the power source will remain the same settings and output state as last time you turned off the power source.
		Last+Off	When the power source is powered on, the power source will remain the same settings as last time you turned off the power source, but the output state is OFF state.
	I/O Config	Select the interface communicated with the computer. The optional interface is dynamically displayed based on different interface cards.	
		NULL	No optional communication interfaces.
		GPIB	When the expansion slot is inserted into the IT-E1205, you can select the GPIB communication interface.

		USB	When the expansion slot is inserted into the IT-E1206 or IT-E1209, you can select the USB communication interface.	
		LAN	When the expansion slot is inserted into the IT-E1206, you can select the LAN communication interface.	
		RS232	When the expansion slot is inserted into the IT-E1207, you can select the RS232 communication interface.	
		CAN	When the expansion slot is inserted into the IT-E1207, you can select the CAN communication interface.	
		Analog	When the expansion slot is inserted into the IT-E1208, you can select the Analog interface.	
	I/O Advance Config	I/O Advance configuration. Based on the communication interface selected by I/O Config, display configurable parameters of the communication interface in detail.		
		GPIB	When the I/O Config selects the GPIB interface, the following information is displayed.	
			GPIB Address	Set the communication address within the range from 1 to 30.
		USB	When the I/O Config selects the USB interface, the following information is displayed.	
			USBTM-C&USBVCP	It is unnecessary to set the advancing parameters for this interface.
		LAN	When the I/O Config selects the LAN interface, the following information is displayed.	
			IP Config	Set the address of the instrument.
			IP Mode	Set IP mode.
			Auto	Auto: automatically configure the address of the instrument.
			Manu	Manual: manually configure the address of the instrument by entering values in the following five fields. The following information only appear when Manu is selected. <ul style="list-style-type: none"> • IP: IP address • Gate: Default gateway • Mask: Subnet mask • DNS1: DNS1 (Primary address)

					<ul style="list-style-type: none"> DNS2: DNS2 (Secondary address)
			Server	Configure the LAN services.	
				Ping	Ping: Ping service state.
					Off On
				mDNS	mDNS: mDNS service state.
					Off On
				VXI-11	VXI-11: VXI-11 service state.
					Off On
				Http	Http: Http service state.
					Off On
				Telnet	Telnet: Telnet service state.
					Off On
				Raw Socket	RAWSocket: RAWSocket service state.
					Off On
				Port	When the RAWSocket function is enabled, it is necessary to set the port number of the Raw- Socket interface.
			LAN Info	Viewing active LAN settings.	
				LAN Status MAC Address IP Address Gateway Address Submask Address DHCP Server Address DNS Server Address Domain Name Host Name Description	
			LAN Reset	Select whether to reset the LAN setting or not.	
				NO YES	
		RS232		When the I/O Config selects the RS232 interface, the following information is displayed.	

		Baudrate	Select the baud rate from the following options: 4800, 9600, 19200, 38400, 57600, 115200. The data bit, parity bit and stop bit are fixed: 8_None_1.
	CAN	When the I/O Config selects the CAN interface, the following information is displayed.	
		Can Address	Set the instrument address to a number from 1 to 127.
		Baudrate	Select the baud rate from the following options: 125k, 250k, 500k.
	Analog	When the I/O Config selects the Analog interface, the following information is displayed.	
		Local/Analog	Enable or disable the analog control: <ul style="list-style-type: none"> Local: local control; Analog: external analog control.
		Ext In Edge	Select the slope of the trigger signal: rising time or falling time.
		External Cal	External voltage control calibration.
	Relay Ctrl	Set the relay control.	
		Out Syn	The relay is linked with Output. When the instrument output is On, the relay is closed; when the instrument output is Off, the relay is open, and the instrument and the load are electrically separated.
		NC	The relay is normally closed. Whether the instrument out is On or Off will not affect the operation of relay.
	System Reset	Select whether to restore the factory default settings or not.	
		No	Don't restore the factory default settings.
		Yes	Restore the factory default settings.
	System Info	View the system information.	
		Manufacturer	Display the manufacturer.
		Model	Display the instrument model.
		Version	Display the software version.
		Serial Number	Display the serial number.
		SCPI Error	Display SCPI command error information.
		Last Cal. Date	Display last calibration date.
		Master Fan	Master power board fan speed rmp.
		Master NTC	Master power plate temperature sensor parameters (negative temperature coefficient).

		Slave Fan	IT-M7723 slave power board fan speed rpm.
		Slave NTC	IT-M7723 slave power plate temperature sensor parameters (negative temperature coefficient).

1.8 Optional Accessories

You can purchase accessories for the IT-M7700 series of instruments separately, including the following:

- **Scalable interface**

The interface expansion slot provided on the rear panel of the IT-M7700 series instrument allows users to flexibly expand according to their needs. Different interface cards can be selected to achieve different functions. Includes communication interface or external analog interface.

- **Cabinet installation**

The IT-M7700 series instruments can be mounted on a standard 19-inch cabinet. ITECH has prepared a special bracket for the user as a mounting kit.

The detailed descriptions of the options are as follows.



Note

The following optional accessories from ITECH are sold separately. Users need to purchase separately.

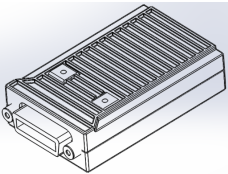
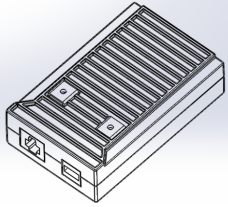
Device Name	Model	Description
GPIB communication interface 	IT-E1205	When the user needs to use GPIB interface to enable remote operation, this option is the right choice.
USB/LAN communication interface 	IT-E1206	When the user needs to use USB and LAN interface to enable remote operation, this option is the right choice.

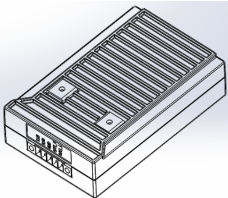
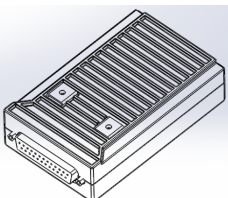
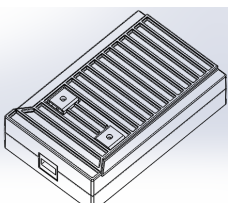
Device Name	Model	Description
RS-232/CAN communication interface 	IT-E1207	When the user needs to use RS-232 and CAN interface to enable remote operation, this option is the right choice.
External analog communication interface 	IT-E1208	When the user needs to use external analog function, this option is the right choice.
USB communication interface 	IT-E1209	When the user needs to use USB interface to enable remote operation, this option is the right choice.
Cabinet installation kit	IT-E154	When the IT-M7721/IT-M7721L/IT-M7722/IT-M7722L needs to be installed in cabinet, this kit is needed. Please refer to 《IT-E154 User Manual》 for detailed description about the installation method.
Cabinet installation kit	IT-E155	When the IT-M7723 needs to be installed in cabinet, this kit is needed. Please refer to 《IT-E155 User Manual》 for detailed description about the installation method.
Cabinet installation kit	IT-E157	When the IT-M7723E needs to be installed in cabinet, this kit is needed. Please refer to 《IT-E157 User Manual》 for detailed description about the installation method.

**Note**

Hot swap is not available for the communication card and analog card. After changing the communication card and analog card, you must re-start the instrument.

2 Inspection and Installation

- ◆ Verifying the Shipment
- ◆ Instrument Size Introduction
- ◆ Connecting the Power Cord
- ◆ Connecting the Device Under Test (DUT)
- ◆ Connecting the Interface

2.1 Verifying the Shipment

Unpack the box and check the contents before operating the instrument. If wrong items have been delivered, if items are missing, or if there is a defect with the appearance of the items, contact the dealer from which you purchased the instrument immediately.

Table 2–1 Package box contents

Item	Qty.	Model	Remarks
Programmable AC Power Source	-	IT-M7700 series	This series include: IT-M7721/IT-M7722/IT-M7721L/IT-M7722L/IT-M7723/IT-M7723E
Power Cord	X 1	-	User may select an appropriate power cord that matches the specifications of power socket used in the area. See the Section 2.3 Connecting the Power Cord for details.
Multiple instruments connection cables	X 1	IT-E251	When the user needs to connect the System Bus interfaces between Multiple instruments in series operation, multichannel operation and three-phase operation features, this option is the right choice.
Ex-Factory Test Report	X 1	-	It is the test report of the instrument before delivery.

Note

Upon verification of the shipment, keep the package and relevant contents thereof in a safe place. When returning the instrument for warranty service or repair, the specified packing requirements shall be met.

2.2 Instrument Size Introduction

The instrument should be installed at well-ventilated and rational-sized space. Please select appropriate space for installation based on the instrument size.

The detailed dimension drawings of the IT-M7700 series are as follows:

IT-M7721/IT-M7722/IT-M7721L/IT-M7722L

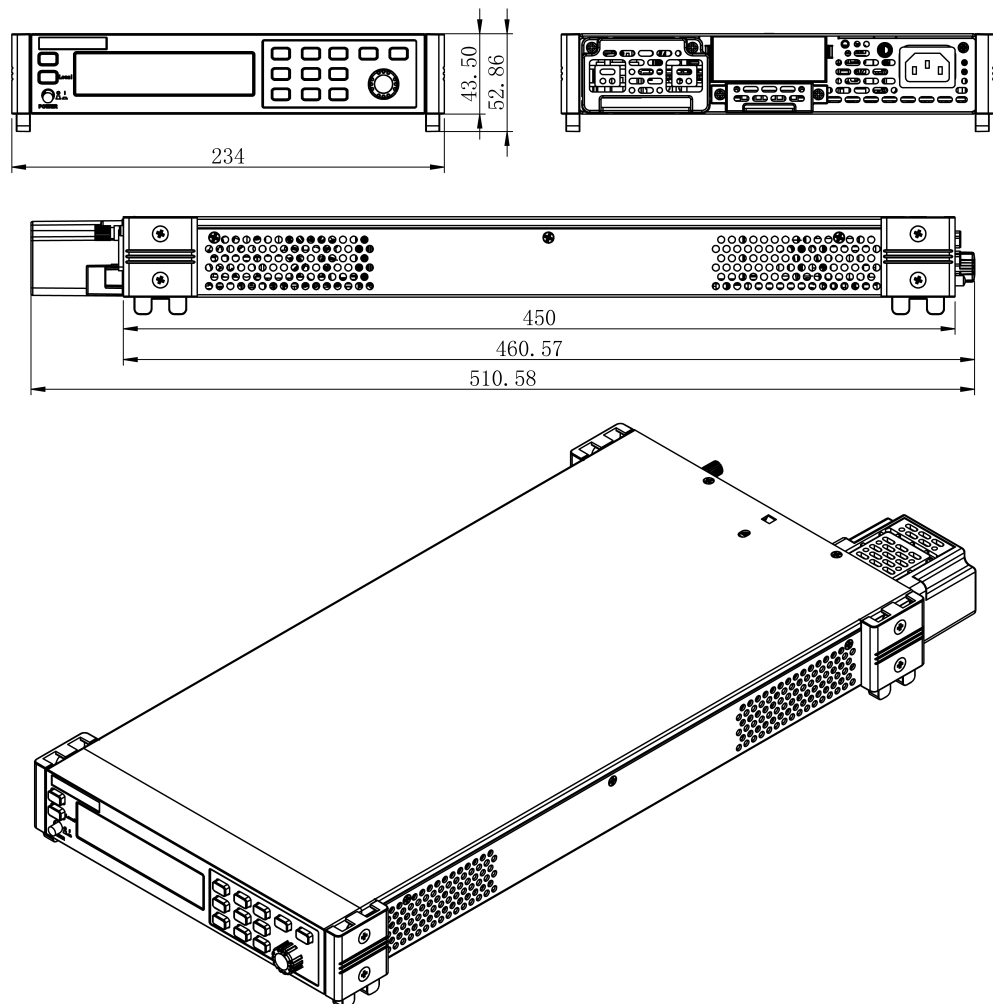

IT-M7723

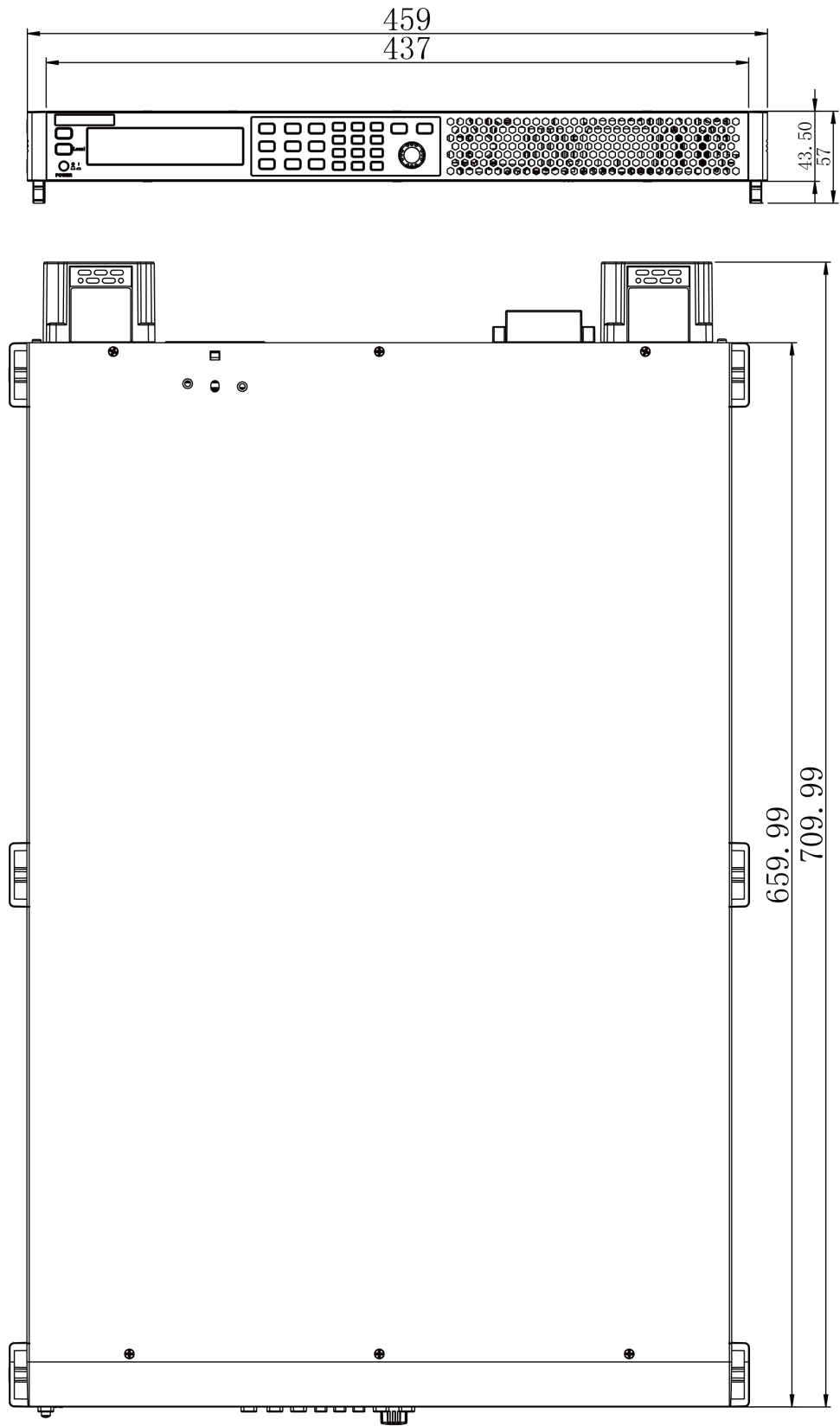

IT-M7723E

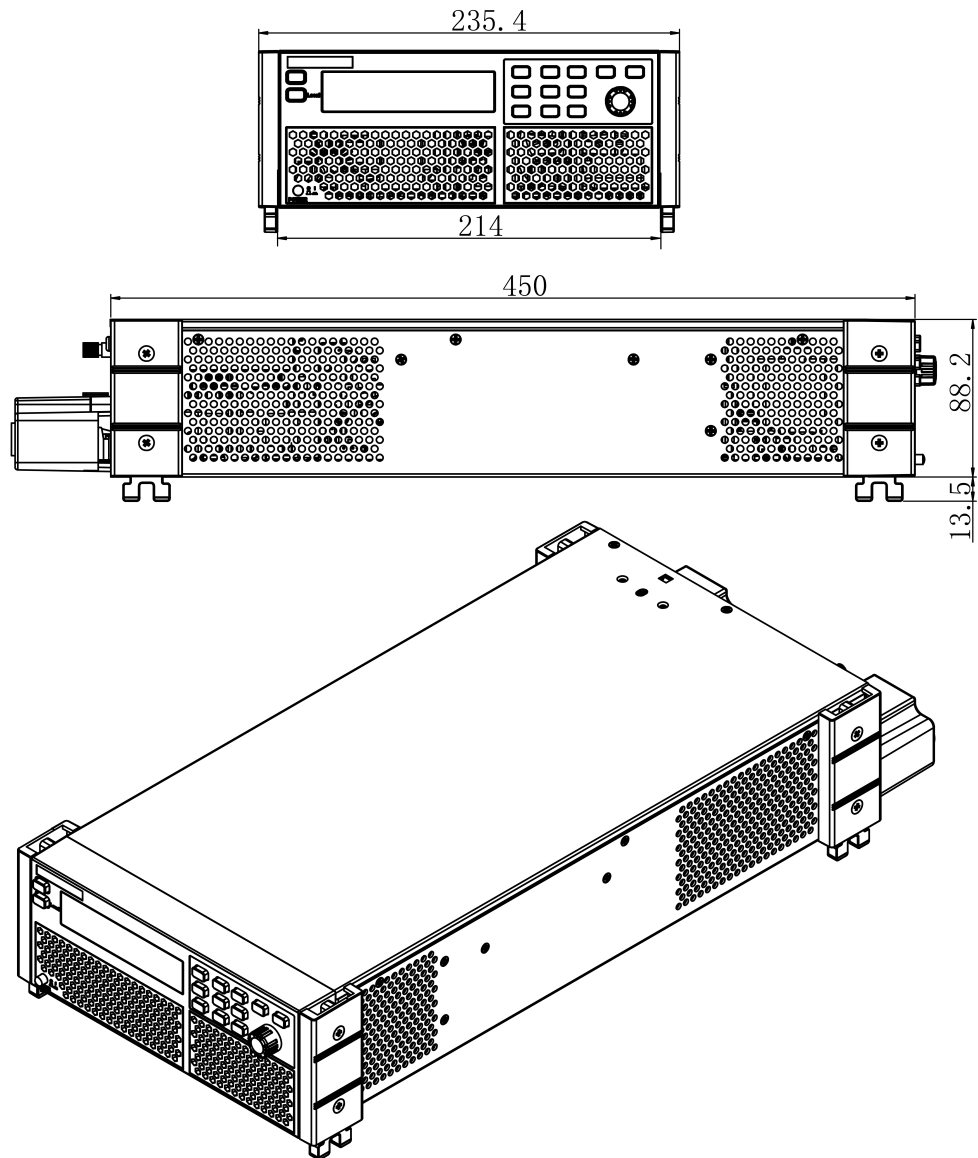

2.3 Connecting the Power Cord

Precautions

To prevent electric shock and damage to the instrument, observe the following precautions.

WARNING

- The power cords supplied with this product is certified for safety. In case the supplied lines assembly needs to be replaced, or an extension lines must be added, be sure that it can meet the required power ratings of this product. Any misuse voids the warranty of this product.
 - Before connecting power cord, be sure to confirm that the power voltage matches with the supply voltage.
 - Before connecting power cord, be sure to switch off the instrument. Power switch is in Off position.
 - To avoid fire or electric shock, make sure to use the power cord supplied by ITECH.
 - Do not use an extended power cord without protective grounding, otherwise the protection function will fail.
 - Be sure to connect the main power socket to the power outlet with protective grounding. Do not use terminal board without protective grounding.
 - The instrument rear panel provides a separate screw used for chassis ground. Please make proper connections. In the event of a failure, not using a properly grounded protective earth and grounded outlet may result in personal injury or death due to electric shock.
-

CAUTION

Safety agency requirements dictate that there must be a way to physically disconnect the AC mains cable from the unit. A disconnect device, either a switch or circuit breaker must be provided in the final installation. The disconnect device must be close to the equipment, be easily accessible, and be marked as the disconnect device for this equipment.

AC Power Input Level

Working voltage for IT-M7700 series power is 100 ~ 240V, AC power input level: 100 ~ 240V, 50 ~ 60Hz.

Power Cord Type and Connecting Method

IT-M7700 series contains many models. Different model is supplied with different power cord. The power cord and connection of different models are introduced as follow.

- IT-M7721/IT-M7722/IT-M7721L/IT-M7722L power supply provides the standard power cords as below. Please select appropriate power cords appropriate to local voltage based on the specifications of power cords below.

If purchased model fails to meet local voltage requirements, please contact distributor or factory for change.

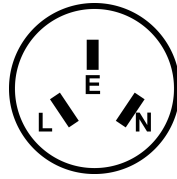

China
IT-E171

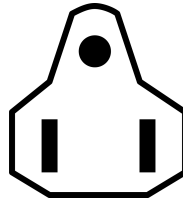

United States &
Canada & Japan
IT-E172

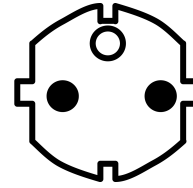

Europe
IT-E173

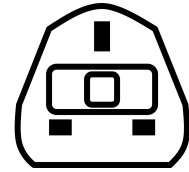

England
IT-E174

Connecting Method:

1. Make sure that the front-panel power switch is in the Off position.
2. Connect the female end of the supplied line cord to the AC receptacle on the rear panel.
3. Connect the plug of the power cord to a grounded AC outlet.

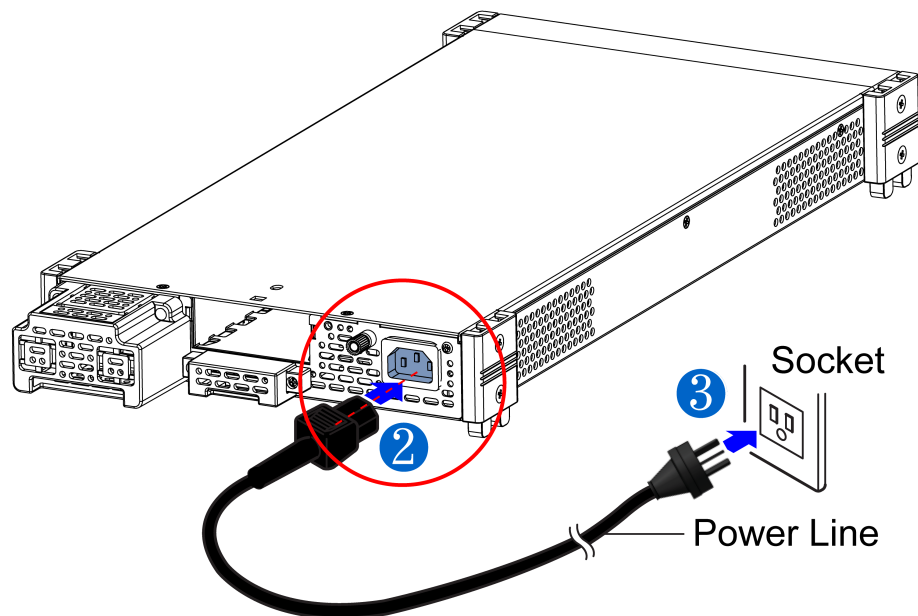

- IT-M7723/IT-M7723E power supply provides the standard power cords as below.

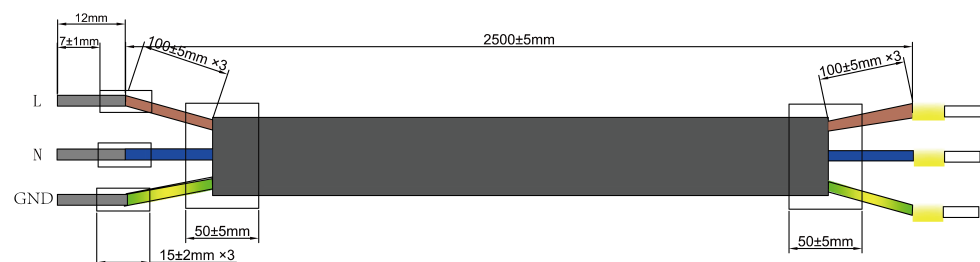

Connecting Method:

1. See the below illustration, one end of the AC power cord is connected to the AC input terminal in the rear board of the power supply. Connect the fire wire, zero line and ground to the corresponding terminal of the device.
2. Connect the three terminals brown to line (L), blue to neutral (N), and yellow-green to ground (PE) on the other end of the power cord to your AC distribution panel.

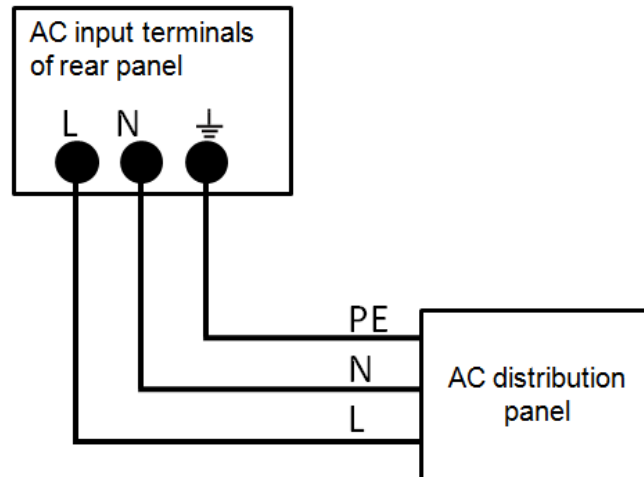

2.4 Connecting the Device Under Test (DUT)

The instrument supports two connection methods between power supply and DUT: Local measurement and Remote sensing.

- Local measurement : The voltage sensed by the instrument is the voltage at the output terminal of the instrument.
- Remote sensing : The voltage sensed by the instrument is the voltage at the terminal of the remote object under test.

Precautions

To prevent electric shock and damage to the instrument, observe the following precautions.

WARNING

- Before connecting DUT, be sure to switch off the power supply. Power switch is in Off position, otherwise touching the output terminals on the rear panel may result in personal injury or death due to electric shock.
- To avoid electrical shock, before testing, please make sure the rating values of the testing cables, and do not measure the current that higher than the rating value. All test cables shall be capable of withstanding the maximum short circuit output current of the power supply without causing overheat.
- If several loads are provided, each pair of load wires shall safely withstand the rated short circuit output current of the power supply under full load.
- During wiring, check that the anode and cathode of the test lines are properly and tightly connected; anode On and cathode Off are prohibited.

Specification

Test cables are not standard accessories for the instrument. Please select optional red and black test cables for individual sales based on the maximum current value. For specifications of test cables and maximum current values, refer to [A.1 Specifications of Red and Black Test Cables](#) for more information.

Connecting the DUT (Local Measurement)

The connection diagram and steps of local sensing are as follows:

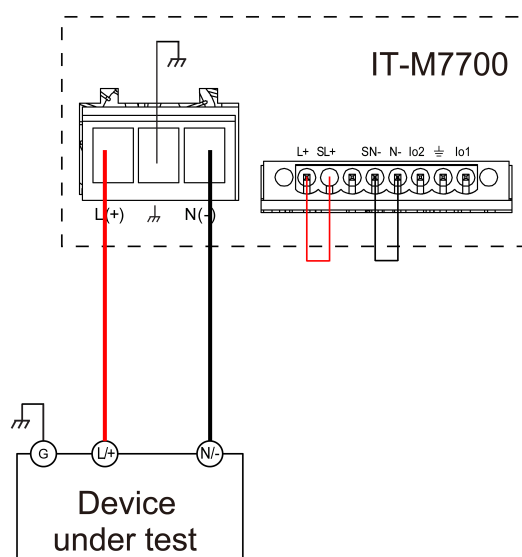

1. Before connecting the DUT, be sure that the instrument Power is in **Off** position.

2. Remove the cover of output terminal and remote sense terminal.
3. Connect the L+ and SL+, N- and SN- for short circuit using the short clips on the back panel of the instrument or electric wire. When using local sense, the remote sense terminal cannot be disconnected.
4. Loosen the screws of the output terminals and connect the red and black test cables to the output terminals, and connect the ground terminal correctly. Re-tighten the screws.
5. Thread the red and black test cables through the output terminals cover of the instrument and install the cover.
6. Directly connect the other end of the red and black cables to the DUT.

Connecting the DUT (Remote Sensing)

When the DUT consumes large current or the wires are too long, there is a voltage drop on the wires between the DUT and output terminal of the power supply. To maximize measurement accuracy, you can use remote sense wire connections to monitor and improve the voltage adjustment on the DUT and compensate for the voltage drop on the wires .

When the power supply is used for measuring battery charge in actual applications, the voltage drop of the wire will lead to voltage inconsistency of both ends and inconsistency of the cutoff voltage of power supply and the actual voltage of battery, resulting in inaccurate measurement.

The connection diagram and steps of remote sensing are as follows:

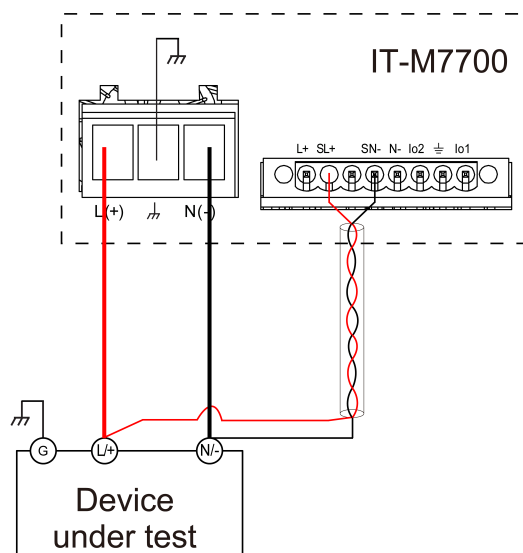

1. Confirm that the power switch is in the **Off** position
2. Remove the cover of output terminal and remote sense terminal.
3. Disconnect the wires/short clips between SL+ and L+, SN- and N-.
4. Use armored twisted-pair cables to connect the remote sense terminals and the device under test.

5. Loosen the screws of the output terminals and connect the red and black test cables to the output terminals, and connect the ground terminal correctly. Re-tighten the screws.
6. Install the terminal cover, leave the other end of remote sense cables and the red and black cables outside.
7. Connect the other end of the remote sense cables and the red and black cables to the DUT.

Note

Test lines and sense lines should be as short as possible, and sense lines should be twisted together.

2.5 Connecting the Interface

The IT-M7700 series power supply has no standard-equipped interfaces card. Users can purchase interface cards separately. Users can choose one of RS-232, USB, GPIB, LAN, CAN to communicate with the computer. For details, see [1.8 Optional Accessories](#)

The reserved interface card installation slot is on the rear panel of the instrument. Users can install it directly after purchasing the interface card. Hot swap is not available for the interface card. After changing the interface card, you must re-start the instrument.

The installing steps for the purchased interface card are as follows:

1. Remove the plug of the rear panel interface.
 - a. Use a small flat screwdriver to press the clip at the upper cover opening.
 - b. At the same time, use another small flat screwdriver to stir the slots one by one from another opening of the upper cover, and push the plastic plug out.

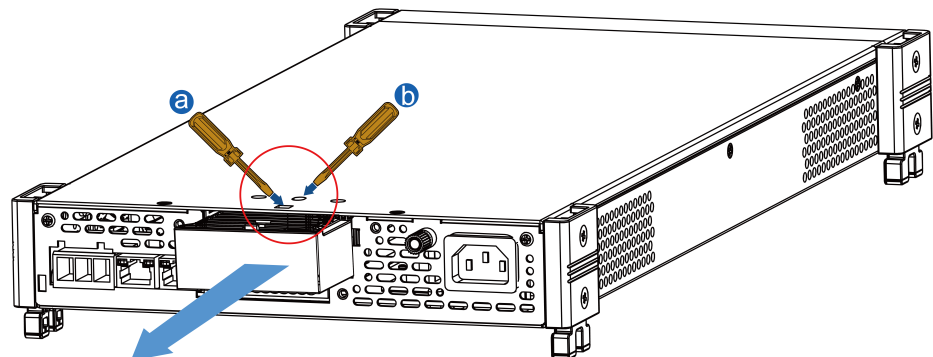

2. Install the purchased communication card. Taking the LAN+USB interface card as an example, push the card into the slot and secure with the screws

from the upper cover, it is shown as follow.

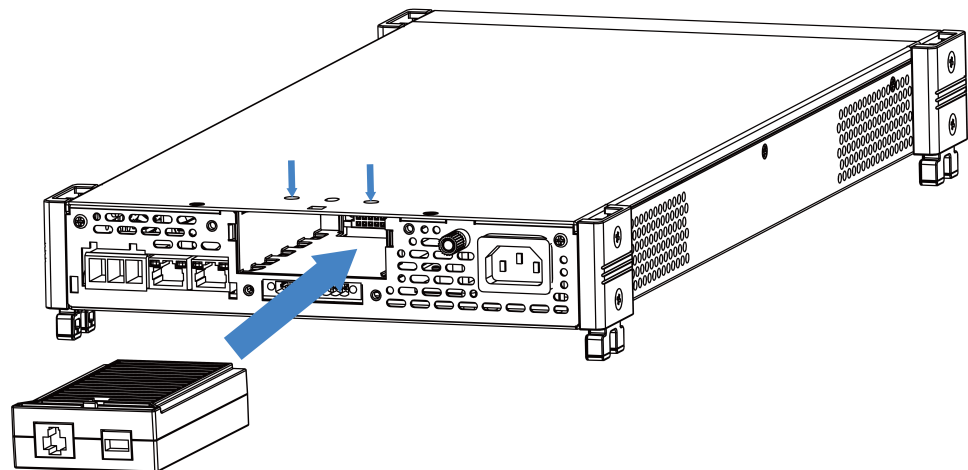

Note

Firstly loosen the screws between upper cover and communication card and removing the communication card like removing the plug, please use the tools and remove it.

2.5.1 USB Interface

When the optional interface card is a stand-alone USB interface (IT-E1209) or USB+LAN interface (IT-E1206), the following can help users quickly understand the steps required to connect the USB interface. The figure below shows a typical USB interface system.

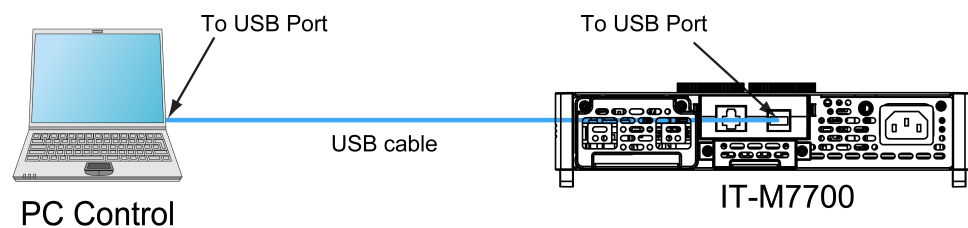

Note

Take the IT-E1209 communication card box as an example. If you install IT-E1206, please refer to the actual interface position.

The operation steps to use the USB interface are as follows.

1. Refer to the USB connection diagram, Connect the power supply and the computer using a cable with two USB interfaces (each end).
2. Press the composite keys **[Shift] + [DC]**(System) to enter into the system menu interface.
3. Rotate the knob to select **I/O Config** and press **[Enter]** key to confirm.

4. Rotate the knob to select **USB** and press **[Enter]** key to confirm. The USB communication supports the following two interface types and no need to select manually..
 - TMC: USB_TMC interface. When the host software uses USBTMC for communication, this USB is the USB_TMC interface.
 - VCP: USB_VCP virtual serial port. When the host software uses the USBVCP for communication(The WIN7/XP system needs to be installed with IT-7722-VCP.inf. Download from the ITECH website or contact ITECH agent), this USB is the USB_VCP interface.
5. Press **[Esc]** to exit the system menu setting.

2.5.2 GPIB Interface

When the optional interface card is a GPIB interface (IT-E1205), you need to know the following. Each device on the GPIB (IEEE-488) interface must have a unique whole number address between 1 and 30. Your computer's GPIB interface card address must not conflict with any instrument on the interface bus. This setting is nonvolatile; it will not be changed by power cycling or *RST. The figure below shows a typical GPIB interface system.

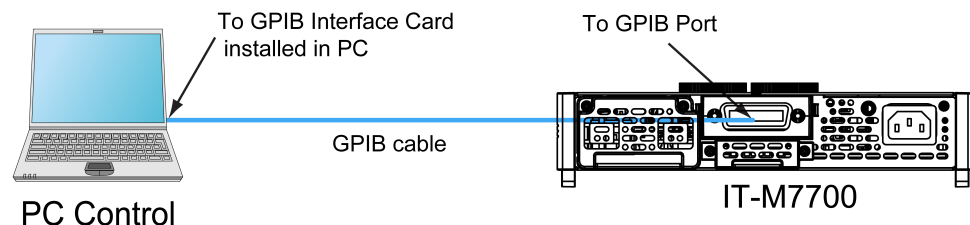

The operation steps to use the GPIB interface are as follows.

1. Refer to the GPIB connection diagram, Connect the power supply and the computer using a IEEE-488 bus.
2. Press the composite keys **[Shift] + [DC]**(System) to enter into the system menu interface.
3. Rotate the knob to select **I/O Advance Config** and press **[Enter]** to enter the GPIB advanced setting interface.
4. Rotate the knob to select **GPIB Address** and press **[Enter]** key to confirm.
5. Use left and right keys or rotate the knob to adjust the GPIB address and press **[Enter]** key to confirm.
6. Press **[Esc]** to exit the system menu setting.

2.5.3 LAN Interface

When the user's optional interface card is a LAN+USB interface (IT-E1206), the following is required to use the LAN interface.

Connect Interface

Use the following steps to quickly connect your instrument to your LAN and configure it. Two typical LAN interface systems are described below: private LAN and site LAN.

- **Connect to the private LAN**

A private LAN is a network in which LAN-enabled instruments and computers are directly connected. They are typically small, with no centrally managed resources. When connected to a computer, a crossover cable can be used to connect directly to the computer via the LAN interface.

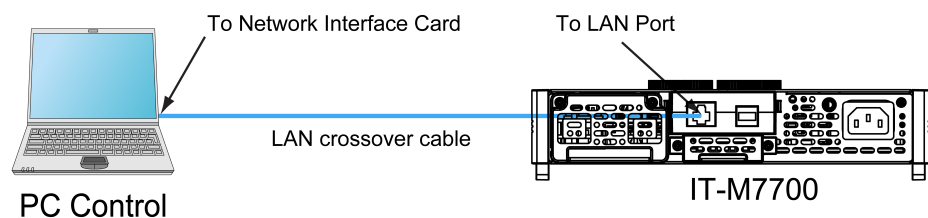

- **Connect to the site LAN**

A site LAN is a local area network in which LAN-enabled instruments and computers are connected to the network through routers, hubs, and/or switches. They are typically large, centrally-managed networks with services such as DHCP and DNS servers. When connected to a computer, a direct attached network cable can be used to connect to the router, and the computer is also connected to the router.

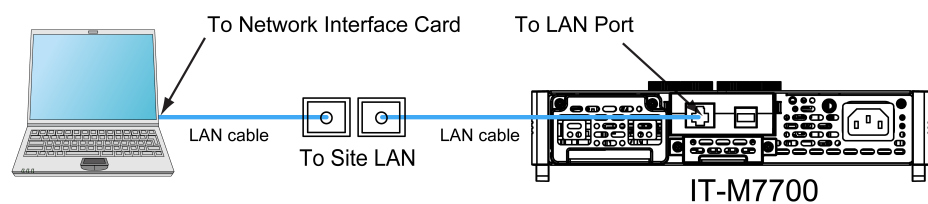

Note

- When using one crossover cable to connect PC directly, the gateway address of the instrument should be consistent with that of the PC, and the IP address should be at the same network segment with the PC's IP address.
- When the instrument and computer are connected to the router, an independent IP address must be assigned for the instrument.

LAN Status Indicator

The lower icon notes the two status LEDs located at the bottom of the LAN port.

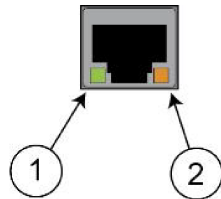

If neither of the LEDs is lit, the network is not connected.

- Position 1: when lit, it indicates that the LAN port is connected.
- Position 2: When flashing, it indicates that the LAN port is receiving or sending a message.

Configure LAN Interface Information

When shipped, DHCP is on, which may enable communication over LAN. The letters DHCP stands for Dynamic Host Configuration Protocol, a protocol for assigning dynamic IP addresses to devices on a network. With dynamic addressing, a device can have a different IP address every time it connects to the network.

The user can view the related information of LAN interface or configure the communication parameters in system menu.

- Automatically configure the address of the instrument. (Auto)

When selected, the instrument will first try to obtain an IP address from a DHCP server. If a DHCP server is found, the DHCP server will assign an IP address, Subnet Mask, and Default Gateway to the instrument. If a DHCP server is unavailable, the instrument will try to obtain an IP address using AutoIP. AutoIP automatically assigns an IP address, Subnet Mask, and Default Gateway addresses on networks that do not have a DHCP server.

- Manually configure the address of the instrument. (Manual)

Set the following parameter. The following information only appear when Manual is selected.

- IP: This value is the Internet Protocol (IP) address of the instrument. An IP address is required for all IP and TCP/IP communications with the instrument. An IP Address consists of 4 decimal numbers separated by periods. Each decimal number ranges from 0 through 255 with no leading zeros (for example, 169.254.2.20).
- Gate: This value is the IP Address of the default gateway that allows the instrument to communicate with systems that are not on the local subnet, as determined by the subnet mask setting. The same numbering notation applies as for the IP Address. A value of 0.0.0.0 indicates that no default gateway is defined.
- Mask: This value is used to enable the instrument to determine if a client IP address is on the same local subnet. The same numbering notation

applies as for the IP Address. When a client IP address is on a different subnet, all packets must be sent to the Default Gateway.

- DNS1: This field enters the primary address of the server. Contact your LAN administrator for server details. The same numbering notation applies as for the IP Address. A value of 0.0.0.0 indicates that no default server is defined.

DNS is an internet service that translates domain names into IP addresses. It is also needed for the instrument to find and display its host name assigned by the network. Normally, DHCP discovers the DNS address information; you only need to change this if DHCP is unused or not functional.

- DNS2: This field enters the secondary address of the server. Contact your LAN administrator for server details. The same numbering notation applies as for the IP Address. A value of 0.0.0.0 indicates that no default server is defined.

Operation Steps:

1. Press the composite keys **[Shift] + [DC]**(System) to enter into the system menu interface.
2. Rotate the knob to select **I/O Config** and press **[Enter]** key to confirm.
3. Rotate the knob to select **LAN** and press **[Enter]** key to confirm.
4. Rotate the knob to select **I/O Advance Config** and press **[Enter]** to enter the LAN advanced setting interface.
5. Rotate the knob to select **IP Config** and press **[Enter]** key to set the instrument address.
6. Rotate the knob to select **IP Mode** and press **[Enter]** key to select the IP setting mode.
 - Auto: automatically configure the addressing of the instrument;
 - Manu: manually configure the addressing of the instrument. If Manu is selected, set the parameters such as IP and Gate.
7. After setting, press **[Esc]** to exit.

Reset the LAN Setting

After configuring the LAN settings, the user need to reset the settings to make it valid in the instrument. The operation steps to reset the LAN settings are as follows.

1. Press the composite keys **[Shift] + [DC]**(System) to enter into the system menu interface.
2. Rotate the knob to select **I/O Config** and press **[Enter]** key to confirm.
3. Rotate the knob to select **LAN** and press **[Enter]** key to confirm.
4. Rotate the knob to select **I/O Advance Config** and press **[Enter]** to enter the LAN advanced setting interface.

5. Rotate the knob to select **LAN Reset** and press **[Enter]** key to reset the LAN parameter configuration.
 - NO: indicates refuse to reset the LAN setting.
 - YES: indicates reset the LAN setting.

View LAN Interface Information

The operation steps to view the LAN interface information are as follows.

1. Press the composite keys **[Shift] + [DC]**(System) to enter into the system menu interface.
2. Rotate the knob to select **I/O Config** and press **[Enter]** key to confirm.
3. Rotate the knob to select **LAN** and press **[Enter]** key to confirm.
4. Rotate the knob to select **I/O Advance Config** and press **[Enter]** to enter the LAN advanced setting interface.
5. Rotate the knob to select **LAN Info** and press **[Enter]** to view the LAN interface information.
6. Rotate the knob to view the LAN interface information. Refer to [1.7 System Menu at a Glance](#) for more information.
7. After setting, press **[Esc]** to exit.

Enable LAN services

The configurable services include: mDNS, Ping, Http, Telnet, VXi-11 and Raw Socket. When using the LAN interface, these services are enabled by default and can be used directly. If you need to turn it off or on again, please refer to the following steps:

1. Press the composite keys **[Shift] + [DC]**(System) to enter into the system menu interface.
2. Rotate the knob to select **I/O Config** and press **[Enter]** key to confirm.
3. Rotate the knob to select **LAN** and press **[Enter]** key to confirm.
4. Rotate the knob to select **I/O Advance Config** and press **[Enter]** to enter the LAN advanced setting interface.
5. Rotate the knob to select **Server** and press **[Enter]** key to enable or disable the LAN service.
6. Rotate the knob to select the service you want to enable and press **[Enter]** key to confirm.
7. Rotate the knob to switch **On** and **Off** options. After selecting **On** or **Off**, press **[Enter]** key to confirm.
 - On: indicates enable the service.
 - Off: indicates disable the service.
8. When enabling the Raw Socket service, the user needs to set the corresponding Port.
9. After setting, press **[Esc]** to exit.

2.5.3.1 Using Http Server

The instrument has a built-in Http server for monitoring and controlling the instrument via a Http browser in PC. To use the Http server, connect the instrument and PC over LAN interface and enter the instrument's IP address into the address bar at the top of your PC's Http browser, you can access the front panel control functions including the LAN configuration parameters.

Note

- If you want to remotely control the instrument using the built-in Http server, you must enable the Http service. See [2.5.3 LAN Interface](#) for details.
- Up to six simultaneous connections are allowed. With additional connections, performance will be reduced.

As shipped, the login password of the Http interface defaults to 12345678. To change the password, click the Security button in the navigation bar on the left side of the window after login.

Enter the password and then click the LOGIN button, the Http interface will appear in the browser as shown below.

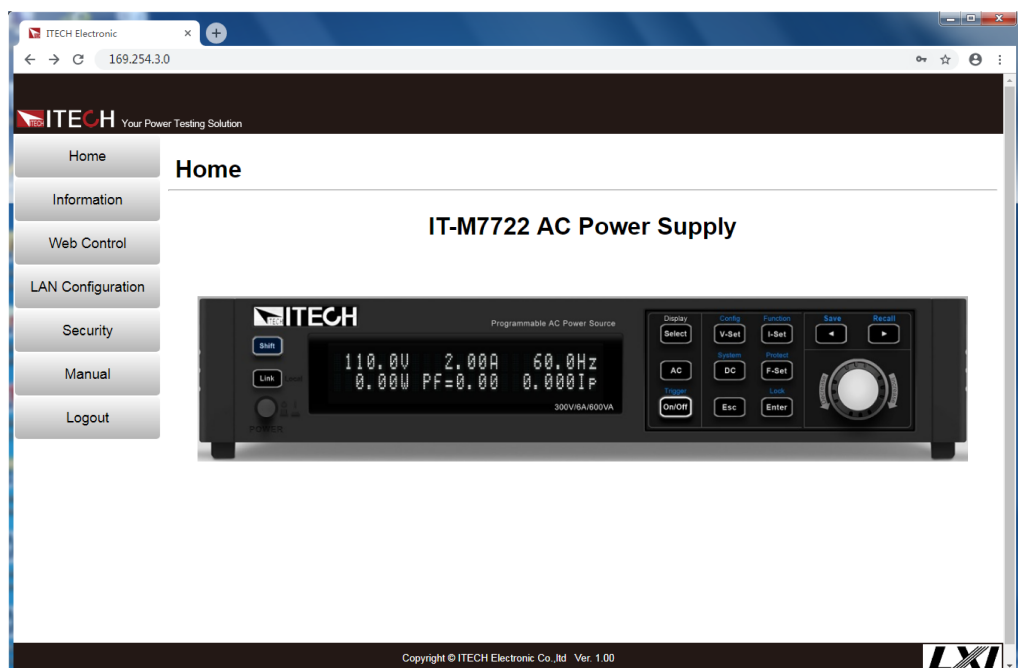

You can select different interfaces by clicking the seven buttons shown in the navigation bar on the left side of the window. The detailed descriptions are as follows.

- Home: Http home interface, displays the model and appearance of the instrument.
- Information: Displays the serial number of the instrument and more system information as well as LAN configuration parameters.

- **Web Control:** Enables the Web control to begin controlling the instrument. This page allows you to monitor and control the instrument.
- **LAN Configuration:** Reconfigure the LAN parameters.
- **Security:** Change the password and control access to the Http interface.
- **Manual:** Go to the ITECH official website and view or download the relevant documents.
- **Logout:** Logout the Http interface.

2.5.3.2 Using Telnet

The Telnet utility (as well as sockets), is another way to communicate with the instrument without using I/O libraries or drivers. In all cases, you must first establish a LAN connection from your computer to the instrument as previously described.

In an MS-DOS Command Prompt box, type “telnet hostname” where hostname is the instrument’s IP address. Press the Enter key and you should get a Telnet session box with a title indicating that you are connected to the instrument and 23 is the instrument’s telnet port. Type the SCPI commands at the prompt.

2.5.3.3 Using Sockets

CAUTION

The instruments allow any combination of up to six simultaneous socket and telnet connections to be made.

ITECH instruments have SCPI socket services, which can be used to send and receive ASCII/SCPI commands, queries, and query responses. All commands must be terminated with a new line for the message to be parsed. All query responses will also be terminated with a new line.

2.5.4 RS-232 Interface

When the optional interface card is RS232+CAN interface (IT-E1207), the following can help users quickly understand the steps required to connect the RS-232 interface. The figure below shows a typical RS-232 interface system that connects to your computer using an RS-232 cable.

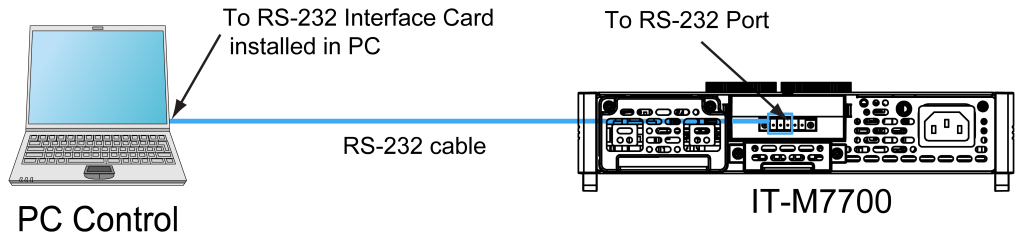

Definition of RS-232 Pins

The definition of RS-232 pins are as follows.

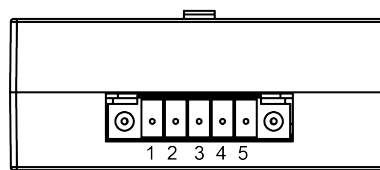

IT-E1207

Pins	Description
1	TXD, transmit data
2	RXD, receive data
3	GND
4	CAN_H
5	CAN_L

RS-232 Connection

Directly connected to the computer, as shown below:

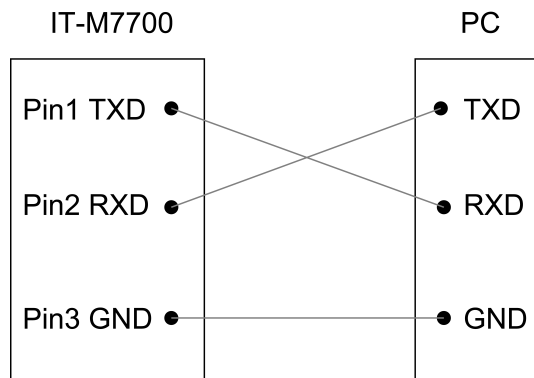

RS-232 Configuration

The user needs to configure the RS-232 interface parameters in the system menu before using the remote control. The RS-232 interface parameters are as follows.

Name	Description
Baud rate	Select the baud rate from the following options: 4800, 9600, 19200, 38400, 57600, 115200.
Data Bit	8 (fixed)
Parity bit	None (fixed)
Stop bit	1(fixed)

The operation steps are as follows.

1. Press the composite keys **[Shift] + [DC]**(System) to enter into the system menu interface.
2. Rotate the knob to select **I/O Config** and press **[Enter]** key to confirm.
3. Rotate the knob to select **RS-232** and press **[Enter]** key to confirm.
4. Rotate the knob to select **I/O Advance Config** and press **[Enter]** key to enter the RS-232 Advancing Setting interface.
5. Rotate the knob to select **Baud Rate** and press **[Enter]** key to confirm.
6. Use left and right keys or rotate the knob to set the communication baud rate, and press **[Enter]** key to confirm.
7. Press **[Esc]** to exit the system menu setting.

RS-232 Troubleshooting

If you meet some problems when communicating with PC by RS-232 interface, please check the following items:

- PC and power source must have the same baud rate.
- Ensure you have used the correct communication cable (CAN_H, CAN_L). Please pay attention that some cable may not have a correct internal wiring even it is with an appropriate interface.
- The cable must be connected to the correct serial ports (COM1, COM2, etc) of PC.

2.5.5 CAN Interface

When the optional interface card is RS232+CAN interface (IT-E1207), the following can help users quickly understand the steps required to connect to the CAN interface.

The following figure shows the CAN interface system. The user can select the CAN interface converter to connect to your computer according to the actual situation. Take the CAN to USB interface device as an example.

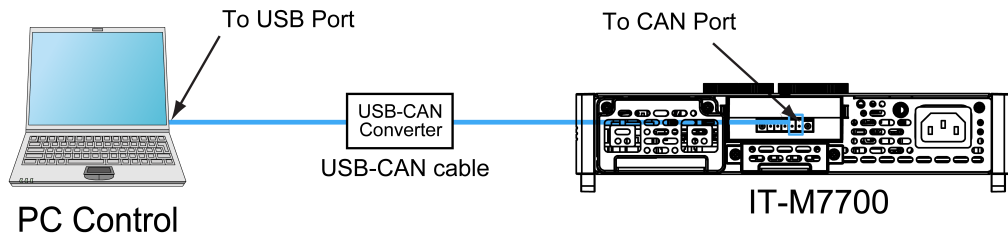

Definition of CAN Pins

The definition of CAN pins are as follows.

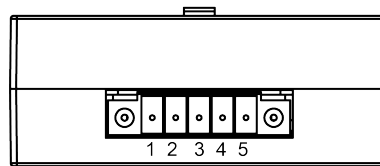

IT-E1207

Pins	Description
1	TXD, transmit data
2	RXD, receive data
3	GND
4	CAN_H
5	CAN_L

CAN Configuration

The user needs to configure the CAN interface parameters in the system menu before using the remote control. The CAN interface parameters are as follows.

Name	Description
Baud rate	Select the baud rate from the following options: 125k, 250k, 500k.
Instrument Address	Range: 1 to 127.

The operation steps are as follows.

1. Press the composite keys **[Shift] + [DC]**(System) to enter into the system menu interface.
2. Rotate the knob to select **I/O Config** and press **[Enter]** key to confirm.
3. Rotate the knob to select **CAN** and press **[Enter]** key to confirm.
4. Rotate the knob to select **I/O Advance Config** and press **[Enter]** key to enter the CAN Advancing Setting interface.
5. Rotate the knob to select **Can Address** and press **[Enter]** key. After setting the communication address, press **[Enter]** key to confirm.

6. Rotate the knob to select **Baudrate** and press **[Enter]** key. After setting the baudrate, press **[Enter]** key to confirm.
7. Press **[Esc]** to exit the system menu setting.

CAN Troubleshooting

If you meet some problems when communicating with PC by CAN interface, please check the following items:

- PC and power source must have the same baud rate.
- Ensure you have used the correct communication cable (CAN_H, CAN_L). Please pay attention that some cable may not have a correct internal wiring even it is with an appropriate interface.

3 Getting Started

Before learning the details of IT-M7700, let us briefly cover the use of the IT-M7700.

- ◆ Power-on the Instrument
- ◆ Applying DC Output
- ◆ Applying Waveform Output

3.1 Power-on the Instrument

Precautions

To prevent electric shock and damage to the instrument, observe the following precautions.

WARNING

- **Before connecting power cord, be sure to confirm that the power voltage matches with the supply voltage.**
- **Be sure to connect the main power socket to the power outlet with protective grounding. Do not use terminal board without protective grounding. Before operation, be sure that the instrument is well grounded.**
- **Ensure that the output electrodes are either insulated or covered using the safety covers provided, so that no accidental contact with lethal voltages can occur.**
- **If you notice strange sounds, unusual odors, fire, or smoke around or from inside the instrument, flip the POWER switch to the (O) side to turn the instrument off, or remove the power cord plug from the outlet. The detachable power cord may be used as an emergency disconnecting device. Removing the power cord will disconnect AC input power to the unit.**

Power Switch Introduction

The power switch is located in the lower left corner of the front panel. See [1.2 Front Panel at a Glance](#) for details. The power switch is a push button. Press the button once to turn the instrument on and press it again to turn the instrument off.

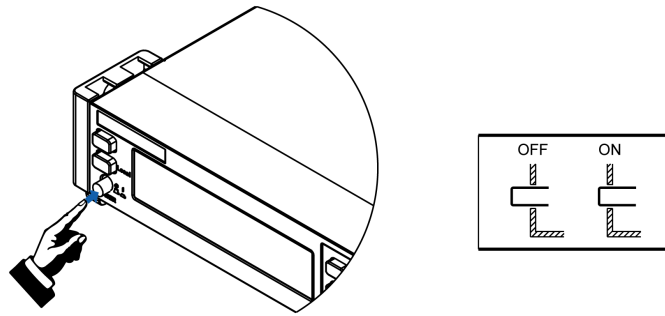

Turning the POWER Switch On

Check that the power cord is connected properly.

Turn the unit on with the front panel power switch. The front panel display will light up after a few seconds. A power-on self-test occurs automatically when you turn the unit on. This test assures you that the power source is operational.

If a self-test error occurs, an error message will be displayed in the front panel. Press the **[Esc]** button to try to clear the current fault status. The user can also restart the instrument to try to clear the fault status. Wait until the power is turned off and then start again. If the problem still cannot be solved after restarting, please contact the ITECH engineer. Please refer to [Error information list](#) for detailed information about common error messages.



Note

- It may take about 30 seconds or so for the power source to initialize before it is ready for use.
- When you turn the POWER switch on for the first time after purchase, the instrument starts with its factory default settings. Each time thereafter, the instrument starts according to the setting that you selected as outlined in [4.11.5 Set the Power-on State](#).

Turning the POWER Switch Off

Turn the unit off with the front panel power switch. When it is turned off, the instrument interface will prompt “AC Power Off”.

After you turn the POWER switch off, wait at least 10 seconds after the fan stops before you turn the POWER switch back on. Turning the instrument on too soon after you turn it off can cause damage to the inrush current limiter circuit, as well as reduce the life of components such as the POWER switch and the internal input fuses.

3.2 Applying DC Output

The IT-M7700 can be used as a DC power supply. In the following process, the IT-M7700 is configured as a DC power supply and outputs 20V voltage.

1. **Press the [DC] key to set the instrument to DC output mode.**

```
10.0V  2.00A
0.00W          DC MODE
```

2. **Setting the Source value (voltage output value).**

- a. Press **[V-set]** key to position the cursor to the voltage setting value. Meanwhile, the **[V-set]** key will light up.

```
10.0V  2.00A
0.00W          DC MODE
```

- b. Rotate the knob clockwise to increase the voltage setting value and anti-clockwise to decrease the value. Set the required value. When setting the negative voltage value, rotate the current voltage setting value anti-clockwise to 0, and then continue to rotate anticlockwise to the negative voltage value.

The knob can be used together with the left/right navigation keys. Press the left/right navigation keys to move the cursor to a digit. Rotate the knob to change the digit value.

- c. Press **[Enter]** key to confirm the voltage setting value.

Press **[Esc]** key to exit the input mode.

3. **Setting the Limit value (current limit point).**

- a. Press the composite keys **[Shift]+[F-set]**(Protect) to enter Protect menu interface.

```
1:OVP(rms) = 300.00V
2:OVP(peak) = 440.00V
```

- b. Rotate the knob to select **MCL** and press **[Enter]** key to confirm.

```
8:MCL = 20.0A
9:Sense Check = Off
```

- c. Rotate the knob to adjust the max current limit and press **[Enter]** key to confirm.

If the input process suspends for more than 5 seconds, the input mode will be automatically exited. If you want to abandon input, please press **[Esc]** key to exit.

- d. Press **[Esc]** to exit the protection menu setting.

4. **Enable the Output.**

Press **[On/Off]** key to enable the instrument output. When the Output is in On status, the Output **[On/Off]** key will light up; when the Output is in Off status, the Output **[On/Off]** will light off.

5. **Checking the Meter values of voltage, current, and power.**

After the Output is enabled, the instrument will continuously measure and display the Meter values of voltage, current, and power on the front panel.

20.1V 0.08A
1.68W DC MODE



Note

When the power supply is used as a DC power supply, please understand the related ripple parameters for this instrument when served as a DC power supply. If there are strict noise requirements, it is necessary to add additional DC noise filter to obtain low noise and good and stable DC voltage for test.

3.3 Applying Waveform Output

IT-M7700 can be used as a waveform generator. In the following process, IT-M7700 is configured as a waveform generator and outputs 10V/50Hz Sine wave.

1. Press the **[AC]** key to set the instrument to AC output mode.

50.0V 6.00A 60.0Hz
0.00W 0.00Ip 0.00PF

2. Set the AC Voltage.

- a. Press **[V-set]** key to position the cursor to the voltage setting value.

50.0V 6.00A 60.0Hz
0.00W 0.00Ip 0.00PF

- b. Rotate the knob clockwise to increase the voltage setting value and anticlockwise to decrease the value. Set the required value.

The knob can be used together with the left/right navigation keys. Press the left/right navigation keys to move the cursor to a digit. Rotate the knob to change the digit value.

- c. Press **[Enter]** key to confirm the voltage setting value.

Press **[Esc]** key to exit the input mode.

3. Set the AC Frequency.

- a. Press **[F-set]** key to position the cursor to the frequency setting value.

10.0V 6.00A 60.0Hz
0.00W 0.00Ip 0.00PF

- b. Rotate the knob clockwise to increase the frequency setting value and anticlockwise to decrease the value. Set the required value.

The knob can be used together with the left/right navigation keys. Press the left/right navigation keys to move the cursor to a digit. Rotate the knob to change the digit value.

- c. Press **[Enter]** key to confirm the frequency setting value.

Press **[Esc]** key to exit the input mode.

4. Set the AC Phase Angle.

- a. Press the composite keys **[Shift]+[V-set]**(Config) to enter into the configuration menu interface.

```

1:I Range =      High
2:AC + DC =      Off
  
```

- b. Rotate the knob to select **On Phase** and press **[Enter]** key to confirm.

```

3:On Phase =      0.0°
4:Off Phase =      0.0°
  
```

- c. Use left and right keys and rotate the knob to set the starting phase angle. Press **[Enter]** key to confirm.

If the input process suspends for more than 5 seconds, the input mode will be automatically exited. If you want to abandon input, please press **[Esc]** key to exit.

- d. Rotate the knob to select **Off Phase** and press **[Enter]** key to confirm.

```

4:Off Phase =      0.0°
6:Wave =          Sine
  
```

- e. Use left and right keys and rotate the knob to set the ending phase angle. Press **[Enter]** key to confirm.

If the input process suspends for more than 5 seconds, the input mode will be automatically exited. If you want to abandon input, please press **[Esc]** key to exit.

5. Select the Output Waveform.

- a. In the Config menu page, rotate the knob to select **Wave** and press **[Enter]** to enter the setting page.

```

6:Wave =          Sine
7:      --EXIT--
  
```

- b. Rotate the knob to select **Sine** and press **[Enter]** key to confirm.

If the input process suspends for more than 5 seconds, the input mode will be automatically exited. If you want to abandon input, please press **[Esc]** key to exit.

- c. Press **[Esc]** to exit the configuration menu setting.

6. Setting the Limit value (current limit point).

- a. Press the composite keys **[Shift]+[F-set]**(Protect) to enter Protect menu interface.

```

1:OVP(rms) =      300.00V
2:OVP(peak) =     440.00V
  
```

- b. Rotate the knob to select **MCL** and press **[Enter]** key to confirm.

```

8:MCL =          20.0A
9:Sense Check =   Off
  
```

- c. Rotate the knob to adjust the max current limit and press **[Enter]** key to confirm.

If the input process suspends for more than 5 seconds, the input mode will be automatically exited. If you want to abandon input, please press **[Esc]** key to exit.

- d. Press **[Esc]** to exit the protection menu setting.

7. Enable the Output.

Press **[On/Off]** key to enable the instrument output. When the Output is in On status, the Output **[On/Off]** key will light up; when the Output is in Off status, the Output **[On/Off]** will light off.

8. Check the Meter value of the instrument.

After the output is enabled, the instrument will continuously measure and display the Meter values of Vrms, Irms, Freq, Ip, PF, Q, P, S, vTHD, and iTHD on the front panel.

```
10.03V   0.0005A   50.0Hz
 0.00W   0.0056Ip  1.00PF
```

Press the **[Select]** key to switch the display of Meter value.

```
10.03V   0.0005A   Q=   0.0
 0.00W    0.0VA    vTHD=1.02
```



Note

IT-M7721L/IT-M7722L does not support displaying vTHD and iTHD.

4 Operation and Application

This chapter describes the operation and application of the instrument in details.

- ◆ Select the Output Mode
- ◆ Setting the Voltage Output Range
- ◆ Set the AC Output
- ◆ Set the DC Output
- ◆ Set the Over-current Protection Point
- ◆ Turning the Output On and Off
- ◆ Step or Continue Output
- ◆ Executing Measurement
- ◆ Function Operation
- ◆ Protection Function
- ◆ System-Related Operations
- ◆ External Analog Quantity Function (Option)

4.1 Select the Output Mode

The IT-M7700 series power supply has 3 output modes: AC, DC and AC+DC. The User should set specific output mode based on required applications.

AC Mode

This mode is the default mode when the instrument is powered on (It is necessary to press **[AC]** key to switch the DC mode back to the AC mode), indicating that the instrument is used as AC power supply. Under this mode, the instrument will generate AC output.

Please refer to [4.3 Set the AC Output](#) for the setting of related output parameters of the instrument under AC mode.

DC Mode

Press **[DC]** key on the front panel to switch the instrument from AC mode to DC mode. At this moment, the instrument serves as a DC power supply. Under this mode, the instrument will generate DC output.

Please refer to [4.4 Set the DC Output](#) for the setting of related output parameters of the instrument under DC mode.

AC+DC Mode

When the AC+DC is turned on, it indicates that the instrument serves as an AC/DC power supply. Under this mode, the instrument will stack DC voltage components based on the generated AC voltage. The turning-on method is as shown below:

1. Press the composite keys **[Shift] + [V-set]**(Config) to enter into the configuration menu interface.
2. Rotate the knob to select **AC+DC** and press **[Enter]** key to confirm.
3. Rotate the knob to switch **On** and **Off** options. After selecting **On**, press **[Enter]** key to confirm.
 - On: indicates that the AC+DC output mode is turned on.
 - Off: default value, indicates that the AC+DC output mode is turned off.
4. Press **[Esc]** to exit the configuration menu setting.

The related output parameters of the instrument under the AC+DC mode must be configured under the AC and DC mode independently. Please refer to [4.3 Set the AC Output](#) and [4.4 Set the DC Output](#).



Note

When the instrument Output is On, it is unable to switch the AC and DC output mode. Only when the instrument Output is Off, you can switch the output mode by pressing the **[AC]** and **[DC]** key.

4.2 Setting the Voltage Output Range

IT-M7723 power supply provides two voltage output ranges for selection: High (high range) and Low (low range). Voltage and current output ranges are shown as follows.

Model	Voltage range	Output range
IT-M7723	High	Voltage output range: <ul style="list-style-type: none"> • AC: 0~600V • DC: 0~±800V Current output range: <ul style="list-style-type: none"> • AC: 0~6A • DC: 0~±6A
	Low	Voltage output range: <ul style="list-style-type: none"> • AC: 0~300V • DC: 0~±400V

Model	Voltage range	Output range
		Current output range: <ul style="list-style-type: none"> • AC: 0~12A • DC: 0~±12A

Operation Steps:

1. Press the composite keys **[Shift] + [V-set]**(Config) to enter into the configuration menu interface.
2. Rotate the knob to select **V Range** and press **[Enter]** key to confirm.
3. Rotate the knob to switch the display among **High** and **Low**. Select one voltage output range and press **[Enter]** key to confirm.
4. Press **[Esc]** to exit the configuration menu setting.



Note

For the voltage output range of other models, please refer to [7 Technical Specification](#).

4.3 Set the AC Output

You can set the voltage, frequency, starting/ending phase angle and waveform type of the AC output. Before operating the AC output, please select the AC output mode.

4.3.1 Set the AC Voltage

The setting range of AC voltage setting value is between 0V and full-scale rated output voltage, which is limited by Vac-Max and Vac-Min, i.e., the Vac setting value should not be higher than Vac-Max and not lower than Vac-Min. Please refer to [4.10.9 Limiting the Setting Value Range](#) for the setting of Vac-Max and Vac-Min.

To set Vac, refer to the steps below:

1. Press the **[AC]** key to set the instrument to AC output mode.
2. Press **[V-set]** key to position the cursor to the voltage setting value. Meanwhile, the **[V-set]** key will light up.

```

50.0V   6.00A   60.0Hz
0.00W   0.00Ip  0.00PF
    
```

3. Rotate the knob clockwise to increase the voltage setting value and anti-clockwise to decrease the value. Set the required value.

The knob can be used together with the left/right navigation keys. Press the left/right navigation keys to move the cursor to a digit. Rotate the knob to change the digit value.

4. Press **[Enter]** key to confirm the voltage setting value.
Press **[Esc]** key to exit the input mode.

4.3.2 Set the AC Frequency

The setting range of AC frequency setting value is between 45.0Hz and 1000.0Hz, which is limited by Freq-Max and Freq-Min, i.e., the Freq setting value should not be higher than Freq-Max and not lower than Freq-Min. Please refer to [4.10.9 Limiting the Setting Value Range](#) for the setting of Freq-Max and Freq-Min.

To set Freq, refer to the steps below:

1. Press the **[AC]** key to set the instrument to AC output mode.
2. Press **[F-set]** key to position the cursor to the frequency setting value. Meanwhile, the **[F-set]** key will light up.

10.0V	6.00A	6 <u>0</u> .0Hz
0.00W	0.00Ip	0.00PF

3. Rotate the knob clockwise to increase the frequency setting value and anti-clockwise to decrease the value. Set the required value.

The knob can be used together with the left/right navigation keys. Press the left/right navigation keys to move the cursor to a digit. Rotate the knob to change the digit value.

4. Press **[Enter]** key to confirm the frequency setting value.
Press **[Esc]** key to exit the input mode.

4.3.3 Set the AC Phase Angle

IT-M7700 series supports the initial phase and stop phase of the output waveform settable to meet different test requirements. The initial phase and stop phase are set in the range of 0.0°~359.9°. By adjusting the phase angle, the user can test the rush current of the product at different positions which is widely applied to various switch current impulse tests and various rectifiers test. The setting steps are as follows:

1. Press the composite keys **[Shift] + [V-set]**(Config) to enter into the configuration menu interface.
2. Rotate the knob to select **On Phase** and press **[Enter]** key to confirm.
3. Use left and right keys and rotate the knob to set the starting phase angle. Press **[Enter]** key to confirm.
4. Rotate the knob to select **Off Phase** and press **[Enter]** key to confirm.

5. Use left and right keys and rotate the knob to set the ending phase angle. Press **[Enter]** key to confirm.
6. Press **[Esc]** to exit the configuration menu setting.

4.3.4 Select the Output Waveform

The user can select the type of output waveform for this power supply, including: sine wave, square wave, triangle wave, saw wave, clip sine wave, THD1~THD30 wave, and USER1~USER5 wave. The setting steps are as follows:

1. Press the composite keys **[Shift] + [V-set]**(Config) to enter into the configuration menu interface.
2. Rotate the knob to select **Wave** and press **[Enter]** key to confirm.
3. Rotate the knob to switch the display of various waveform items. After selecting one waveform, press **[Enter]** key to confirm.
 - Sine: Sinusoidal
 - Square:
 - Triangle
 - Saw: Sawtooth
 - Clip Sine: Clipped Sinusoidal
 - THD1~THD30: 30 sets of built-in waveforms.
 - USER1~USER5: 5 sets of user-defined waveforms.
4. When the Clip Sine output waveform is selected, you can set the clipped percentage.
 - a. Rotate the knob to select **Clip Level** and press **[Enter]** key to enter the setting page.
 - b. Use left and right keys and rotate the knob to set the clipped percentage. Press **[Enter]** key to confirm.
5. Press **[Esc]** to exit the configuration menu setting.



Note

- The user-defined waveforms need to be defined in and downloaded from the remote PC. Refer to the IT-M7700 Series Software User Manual for operation methods.
- Refer to [A.2 Built -in Waveforms](#) for detailed built-in THD waveforms.
- IT-M7721L/IT-M7722L only supports sine waveform.

4.4 Set the DC Output

You can set the voltage and voltage rise time for the DC output. Before operating the DC output, please select the DC output mode.

4.4.1 Set the DC Voltage

The setting range of DC voltage setting value is between 0V and full-scale rated output voltage, which is limited by Vdc-Max and Vdc-Min, i.e., the Vdc setting value should not be higher than Vdc-Max and not lower than Vdc-Min. Please refer to [4.10.9 Limiting the Setting Value Range](#) for the setting of Vdc-Max and Vdc-Min.

To set Vdc, refer to the steps below:

1. Press the **[DC]** key to set the instrument to DC output mode.
2. Press **[V-set]** key to position the cursor to the voltage setting value. Meanwhile, the **[V-set]** key will light up.

```

10.0V   2.00A
0.00W           DC MODE
  
```

3. Rotate the knob clockwise to increase the voltage setting value and anti-clockwise to decrease the value. Set the required value.

The knob can be used together with the left/right navigation keys. Press the left/right navigation keys to move the cursor to a digit. Rotate the knob to change the digit value.

4. Press **[Enter]** key to confirm the voltage setting value.

Press **[Esc]** key to exit the input mode.



Note

When the power supply is used as a DC power supply, please understand the related ripple parameters for this instrument when served as a DC power supply. If there are strict noise requirements, it is necessary to add additional DC noise filter to obtain low noise and good and stable DC voltage for test.

4.4.2 Set the DC Voltage Rise Time

With this power supply, you can set the voltage rise time under the DC mode, with the setting range of 1ms ~ 99,999ms. The voltage rise time means the time when the power supply output voltage reaches the stable setting value for the first time from zero time. You can set the voltage rise time on the front panel or through remote control operation. The set voltage rise time will affect the voltage change speed when the real-time voltage changes. The setting steps are as follows:

1. Press the composite keys **[Shift] + [V-set]**(Config) to enter into the configuration menu interface.
2. Rotate the knob to select **V-Rise Time** and press **[Enter]** key to confirm.
3. Use left and right keys and rotate the knob to set the voltage rise time. Press **[Enter]** key to confirm.
4. Press **[Esc]** to exit the configuration menu setting.

4.5 Set the Over-current Protection Point

With this instrument, you can directly set the over-current protection point value for the OCP (rms) function through the **[I-set]** key. Refer to [4.10.5 Set the Over-Current Protection \(peak\)](#) for the related description of OCP (rms).

The setting range of over-current protection point value is between 0A and full-scale rated output current, which is limited by OCP-Max and OCP-Min, i.e., the over-current protection point value should not be higher than OCP-Max and not lower than OCP-Min. Please refer to [4.10.9 Limiting the Setting Value Range](#) for the setting of OCP-Max and OCP-Min.

To set OCP_{rms}, refer to the steps below:

1. Press **[I-set]** key to position the cursor to the OCP_{rms} setting value. Meanwhile, the **[I-set]** key will light up.

```

50.0V   6.00A   60.0Hz
0.00W   0.00Ip  0.00PF
  
```

2. Rotate the knob clockwise to increase the OCP_{rms} setting value and anticlockwise to decrease the value. Set the required value.

The knob can be used together with the left/right navigation keys. Press the left/right navigation keys to move the cursor to a digit. Rotate the knob to change the digit value.

3. Press **[Enter]** key to confirm the OCP_{rms} setting value.

Press **[Esc]** key to exit the input mode.

4.6 Turning the Output On and Off

WARNING

- The [On/Off] key light is off and turning the output off does not place the instrument in a safe state. Hazardous voltages may be present on all output and guard terminals. Putting the equipment into an output-off state does not guarantee that the outputs are powered off if a hardware or software fault occurs. See the cautions about connecting the DUT before connecting DUT.
- To prevent electrical shock that could cause injury or death, please ensure that the power source and DUT have been connected well before you turn the output on.
- The [On/Off] key is used to turn the output/input on or off under normal circumstances. Even if the instrument is in control by PC or the keyboard is locked, the [On/Off] is still valid.

You can turn the IT-M7700 output on or off from the front panel [On/Off] key. Press the [On/Off] key, and the key lights up, indicating the real-time output is On. The Meter value on the interface will display the voltage, current, or power values of the real-time circuit; press [On/Off] key again, and the key lights off, indicating that the real-time output is Off.

4.7 Step or Continue Output

The voltage value (V-set) and frequency value (F-set) can be output in a step or continue manner. The following takes the voltage value (Vac / Vdc) from 10V to 20V as an example to illustrate the step and continue change process.

Step Output

1. Press the [V-set] key, turn the knob to set the voltage to 10V, and press [Enter] to confirm.
2. Press the [On/Off] key to turn on the instrument output.
3. Press the [V-set] button twice in quick succession to enter the Step output mode (the [V-set] button flashes).
4. Turn the knob to change the output value, and the output waveform value remains constant. After pressing [Enter] to confirm, the output voltage value will change with the input value. The output waveform is shown in the figure below.

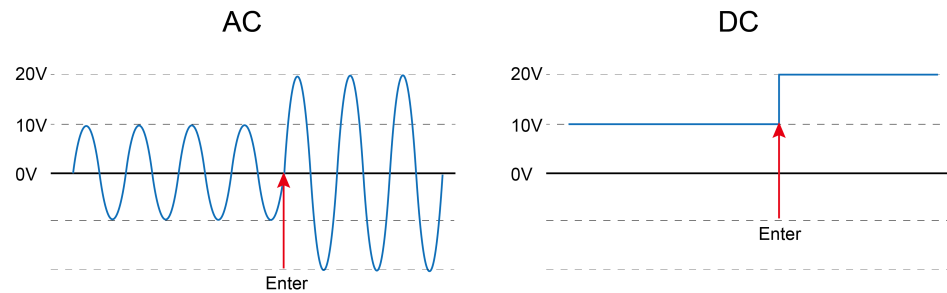

Continue Output

1. Press the **[V-set]** key, turn the knob to set the voltage to 10V, and press **[Enter]** to confirm.
2. Press the **[On/Off]** key to turn on the instrument output.
3. Press the **[V-set]** button twice in quick succession to enter the Continue output mode (the **[V-set]** button stays on).
4. Turn the knob to change the output value, and the output waveform value changes with the input value. After pressing **[Enter]** to confirm, the output voltage will remain in the last state. The output waveform is shown in the figure below.

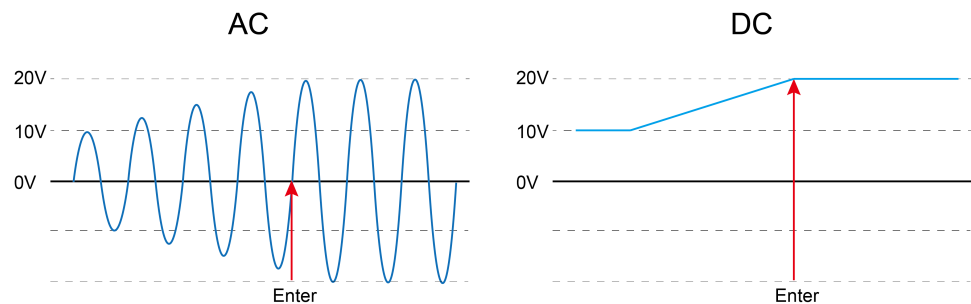

Note

Press the **[V-set]** button twice in quick succession to enter the Step output mode, then press the **[V-set]** button twice in quick succession to enter the Continue output mode.

4.8 Executing Measurement

In this power supply, you can measure actual performance of the output terminal of the power supply without using other measurement instruments. When the power supply Output is On, it will measure the V, I, F, and P of the output terminal of the power supply. Before executing measurement, the user needs to set the current measurement range.

4.8.1 Measurement Functions

This power supply provides measurement functions for 12 types of electrical parameters. All these measurement parameters can be displayed on the main interface.

- Under the DC mode, the DC main interface displays all DC measurements: Vdc, Idc and P.
- Under the AC mode, the AC main interface 1 displays the following AC measurements: Vrms, Irms, F, P, Ip, and PF; and the AC main interface 2 displays the following AC measurements: Vrms, Irms, Q, P, S, vTHD and iTHD. You can use the **[Select]** key to switch between the AC main interface 1 and the AC main interface 2.

The definitions of the functions are listed in the following table:

Function	Definition
AC Mode	
Vrms	It is the measurement of Voltage effective value.
Irms	It is the measurement of Current effective value.
F	It is the measurement of Frequency.
P	Active Power.
Ip	Current peak-to-peak value.
PF	It is the Power Factor, and its calculation formula = P/S.
Q	It is the <u>Reactive</u> Power, and its calculation formula = $Q = \sqrt{S^2 - P^2}$.
S	It is the Apparent Power, and its calculation formula = Vrms × Irms.
vTHD	Total voltage harmonic distortion factor.
iTHD	Total current harmonic distortion factor.
DC Mode	
Vdc	It is the measurement of DC Voltage.
Idc	It is the measurement of DC Current.
P	Power.



Note

IT-M7721L/IT-M7722L does not support displaying vTHD and iTHD.

4.9 Function Operation

4.9.1 Function Menu at a Glance

Press the composite keys **[Shift]+[I-set]**(Function) to enter into the Function menu interface. At this time, the screen displays the optional menu. Click Rotary to page up or page down the menu. Press the **[Enter]** key to enter into the selected menu item. Press the **[Esc]** key to exit the menu function. The descriptions of function menu are listed in the table below.

Table 4–1 IT-M7721/IT-M7722/IT-M7723E menu

Function	Function menu		
	List Mode	List mode	
		Off	Turn the list function off.
		1~5	Turn List 1~5 on.
	List Trigger	Set the trigger mode to run the List.	
		Off	After the Trigger key is pressed, the instrument will automatically run the real-time List file.
		On	After the Trigger key is pressed, the instrument will run the realtime List file in single step.
	Dimmer	Dimmer Function. (only displayed under the AC Mode)	
		Off	Turn the dimmer function off.
		LeadingEdge	Enable the Leading Edge Dimmer function.
			Dimmer Phase Set the leading edge dimmer phase angle.
		TrailingEdge	Enable the Trailing Edge Dimmer function.
			Dimmer Phase Set the trailing edge dimmer phase angle.
	Surge Trap	Surge/trap function.	
		Off	Turn the surge/trap function off.
		On	Turn the surge/trap function on.
			Period Set the period of the surge/trap.
			Width Set the surge/trap width.
			Percent Set the percentage of the surge/ trap amplitude to AC signal amplitude (rms).

	Ext IO1	Parameter setting for IO1.		
		Off	Turn off the IO1 function.	
		Output	Config IO1 as output pin.	
		L if out on	When the output state of the instrument is On, this pin outputs 0V. When the output state of the instrument is Off, this pin outputs 5V.	
		H if out on	When the output state of the instrument is On, this pin outputs 5V. When the output state of the instrument is Off, this pin outputs 0V.	
		Input	Config IO1 as input pin.	
		L To out on	When send 0V signal to IO1, the instrument turns on the output. When send 5V signal to IO1, the instrument turns off the output.	
		H To out on	When send 5V signal to IO1, the instrument turns on the output. When send 0V signal to IO1, the instrument turns off the output.	
		Ext IO2	Parameter setting for IO2.	
			Off	Turn off the IO2 function.
		Output	Config IO2 as output pin.	
		L if out on	When the output state of the instrument is On, this pin outputs 0V. When the output state of the instrument is Off, this pin outputs 5V.	
		H if out on	When the output state of the instrument is On, this pin outputs 5V. When the output state of the instrument is Off, this pin outputs 0V.	
		Input	Config IO2 as input pin.	
		L To out on	When send 0V signal to IO2, the instrument turns on the output. When send 5V signal to IO2, the instrument turns off the output.	
		H To out on	When send 5V signal to IO2, the instrument turns on the output. When send 0V signal to IO2, the instrument turns off the output.	
	Off Timer	Set the output timer function.		
		Off	Turn the output timer off.	
		On	Turn the output timer on.	

			Timer	Set the output time.
--	--	--	-------	----------------------

Table 4–2 IT-M7723 menu

Function	Function menu			
	List Mode	List mode		
		Off	Turn the list function off.	
		1~5	Turn List 1~5 on.	
	List Trigger	Set the trigger mode to run the List.		
		Off	After the Trigger key is pressed, the instrument will automatically run the real-time List file.	
		On	After the Trigger key is pressed, the instrument will run the realtime List file in single step.	
	Dimmer	Dimmer Function. (only displayed under the AC Mode)		
		Off	Turn the dimmer function off.	
		LeadingEdge	Enable the Leading Edge Dimmer function.	
			Dimmer Phase	Set the leading edge dimmer phase angle.
		TrailingEdge	Enable the Trailing Edge Dimmer function.	
			Dimmer Phase	Set the trailing edge dimmer phase angle.
	Surge Trap	Surge/trap function.		
		Off	Turn the surge/trap function off.	
		On	Turn the surge/trap function on.	
			Period	Set the period of the surge/trap.
			Width	Set the surge/trap width.
			Percent	Set the percentage of the surge/ trap amplitude to AC signal amplitude (rms).
	Ext IO1	Parameter setting for IO1.		
		Off	Turn off the IO1 function.	
		Output	Config IO1 as output pin.	
			L if out on	When the output state of the instrument is On, this pin outputs 0V. When the output state of the instrument is Off, this pin outputs 5V.

		H if out on	When the output state of the instrument is On, this pin outputs 5V. When the output state of the instrument is Off, this pin outputs 0V.
	Input	Config IO1 as input pin.	
		L To out on	When send 0V signal to IO1, the instrument turns on the output. When send 5V signal to IO1, the instrument turns off the output.
		H To out on	When send 5V signal to IO1, the instrument turns on the output. When send 0V signal to IO1, the instrument turns off the output.
	Off Timer	Set the output timer function.	
		Off	Turn the output timer off.
		On	Turn the output timer on.
		Timer	Set the output time.

Note

IT-M7721L/IT-M7722L do not support function operation.

4.9.2 List Function

IT-M7700 List mode supports program complex waveform editing. The users can edit 5 list files (List1 to List5), each file can be edited up to 50 steps. Each step settable parameters include: basic waveform (incl. THD and user defined waveform), AC/DC amplitude, slew rate, frequency, dwell time, start/stop phase angle, times of repetition etc. This function with complex waveforms can help users to simulate grid disturbance, periodic power off and so on.

This power supply needs to use the IT-M7700 Series Software to edit the List function contents, and download the List files to local equipment. Then, the instrument can locally run the List function. The user can also run all functions of the List in the IT-M7700 Series Software.

Operation Steps:

1. Edit List Program.

Please refer to "Edit List File" or "Export/Import List in PC" in the *IT-M7700 Series Software User Manual* to edit the List file.

2. Set the List mode.

- a. Press the composite keys **[Shift] + [I-set]**(Function) to enter function menu interface.

```
1:List Mode =      Off
2:List Trigger =   On
```

- b. Rotate the knob to select **List Mode** and press **[Enter]** key to confirm.
 - c. Rotate the knob to select the name of the List file to be run and press **[Enter]** key to confirm.
 - Off: Default value, indicating that the List Mode function is disabled.
 - 1: indicate that the List Mode function is enabled, and List 1 file is called.
 - 2: indicate that the List Mode function is enabled, and List 2 file is called.
 - 3: indicate that the List Mode function is enabled, and List 3 file is called.
 - 4: indicate that the List Mode function is enabled, and List 4 file is called.
 - 5: indicate that the List Mode function is enabled, and List 5 file is called.
3. Set the trigger mode to run the List.
 - a. Select **List Trigger** in the Function menu interface and press **[Enter]** key to confirm.
 - b. Rotate the knob to switch **On** and **Off** options. After selecting **On** or **Off**, press **[Enter]** key to confirm.
 - Off: After the Trigger key is pressed, the instrument will automatically run the real-time List file.
 - On: After the Trigger key is pressed, the instrument will run the real-time List file in single step.
 - c. Press **[Esc]** to exit the function menu setting.
 4. Press the **[On/Off]** key to turn on the instrument output.

```
50.0V  3.00A  50.0Hz
List 5 Step  0/ 7 Stop
```
 5. Press the composite keys **[Shift] + [On/Off]**(Trigger) on the front panel to run the selected List file.

```
50.0V  3.00A  50.0Hz
List 5 Step  1/ 7 Run
```

 - When List Trigger = On, press the Trigger key once, and the instrument will run one step of List output.
 - When List Trigger = Off, the instrument will output based on defined List.



Note

IT-M7721L/IT-M7722L do not support list function.

4.9.3 Dimmer Function

The Dimmer Function aims to adjust the light illuminance intensity by setting the phase angle and concealing the leading edge or trailing edge waveform. This IT-M7700 series power supply supports front and rear phase angle dimmer or speed adjustment test to verify whether the product has potential quality problem when the end user uses dimmer or the speed controller.

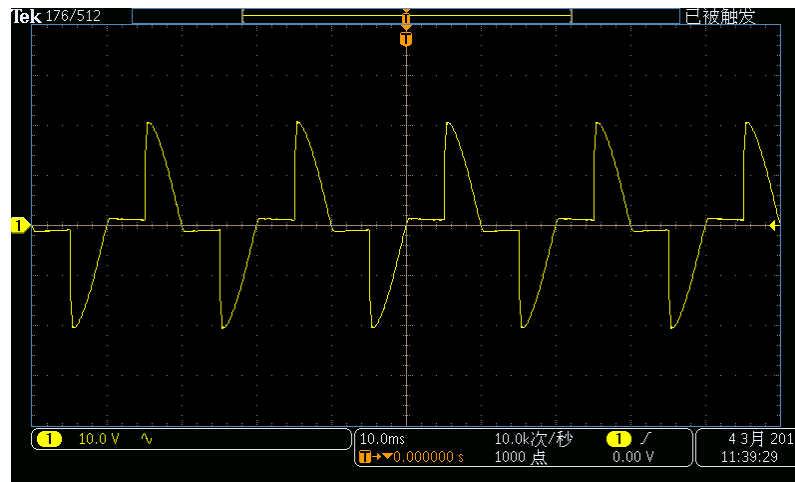
- Dimmer of leading edge



- Dimmer of trailing edge

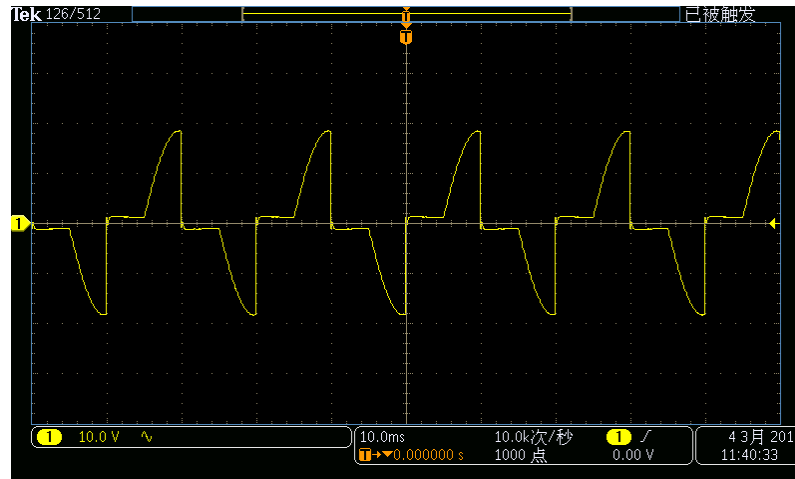

1. Press the **[AC]** key to set the instrument to AC output mode.
2. Refer to [4.3 Set the AC Output](#) to set parameters related to basic Sine waveform.
3. Enable the phase dimmer function.
 - a. Press the composite keys **[Shift] + [I-set]**(Function) to enter function menu interface.
 - b. Rotate the knob to select **Dimmer** and press **[Enter]** key to confirm.
 - c. Rotate the knob to switch the display among **Off**, **LeadingEdge** and **TrailingEdge**. After selecting **LeadingEdge** or **TrailingEdge**, press **[Enter]** key to confirm.

- Off: Default value, indicating that the Dimmer function is disabled.
 - LeadingEdge: indicate that the Leading Edge Dimmer function is enabled.
 - TrailingEdge: indicate that the Trailing Edge Dimmer function is enabled.
4. Set the dimmer phase angle.
 - a. Rotate the knob and select the **Dimmer Phase**. Press **[Enter]** key to set the dimmer phase angle.
 - b. Press **[Esc]** to exit the function menu setting.
 5. Press **[On/Off]** key, and the power supply outputs the set phase dimmer waveform. Press **[On/Off]** again to stop output.

```

10.0V   3.00A   45.0Hz
Phase= 90.0°   TrailingEdge
    
```

Note

- The phase dimmer function can only be used under the AC Mode.
- IT-M7721L/IT-M7722L do not support dimmer function.

4.9.4 Surge/Trap Function

IT-M7700 provides surge/trap simulation. The user can add surge/trap to simulate abnormal voltage fluctuation on the basis of outputting Sin wave, and test usage of the DUT under this circumstance. The descriptions of surge/trap menu are listed in the table below.

Surge Trap	Surge/trap function.		
	Off	Turn the surge/trap function off.	
	On	Turn the surge/trap function on.	
		Period	Set the period of the surge/trap.
		Width	Set the surge/trap width.
		Percent	Set the percentage of the surge/trap amplitude to AC signal amplitude (rms).

Operation Steps:

1. Press the **[AC]** key to set the instrument to AC output mode.
2. Refer to [4.3 Set the AC Output](#) to set parameters related to basic Sine waveform.

3. Turn the surge/trap function on.
 - a. Press the composite keys **[Shift] + [I-set]**(Function) to enter function menu interface.
 - b. Rotate the knob to select **Surge Trap** and press **[Enter]** key to confirm.
 - c. Rotate the knob to switch **On** and **Off** options. After selecting On, press **[Enter]** to turn on the glitch/notch function.
4. Set the parameters of the surge/trap.
 - a. Rotate the knob to select **Period** and press **[Enter]** key to set the period of the surge/trap.
 - b. Rotate the knob to select **Width** and press **[Enter]** key to set the width of the surge/trap.
 - c. Rotate the knob to select **Percent** and press **[Enter]** key to set the percentage of the surge/trap.
 - d. Press **[Esc]** to exit the function menu setting.
5. Press **[On/Off]** key, and the power supply outputs the set surge/trap waveform. Press **[On/Off]** again to stop output.

10.0V 3.00A 50.0Hz
 1Cycle 1.00mS 30.0%

Waveform Example

- The trap diagram when Period=2Cycle, Width=1.00mS, and Percent=30% is as follows:

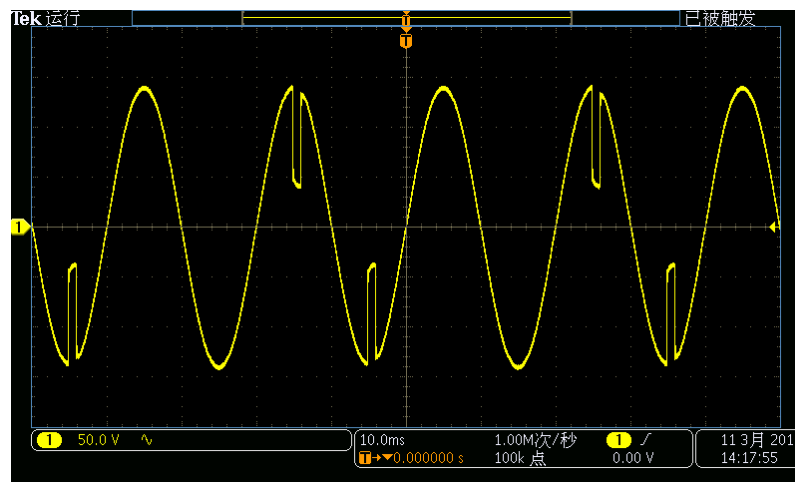

- The surge diagram when Period=1Cycle, Width=0.4mS, and Percent=200% is as follows:

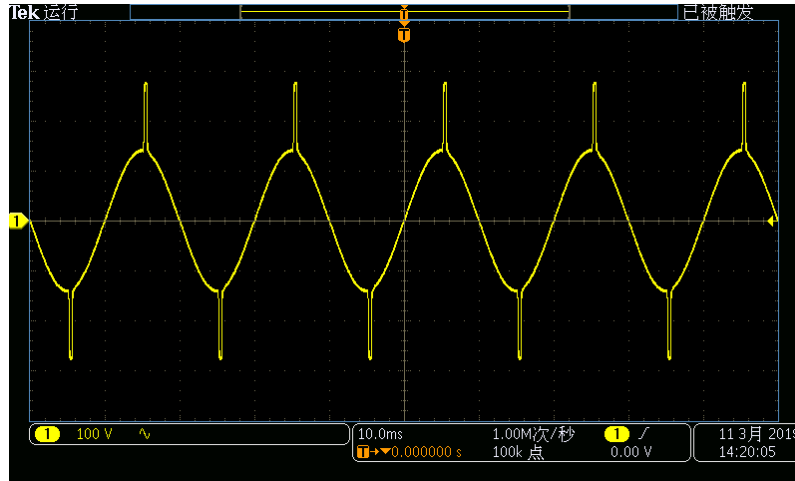

 Note

- The surge/trap function can only be used under the AC Mode.
- IT-M7721L/IT-M7722L do not support surge/trap function.

4.9.5 Digital I/O Function

The IT-M7700 series power supply supports digital I/O function, which can be used for controlling and monitoring power supply output. For position, see [1.4 Rear Panel at a Glance](#).

Description of Digital I/O pin

The appearance of the I/O pin are shown below.

- IT-M7721/IT-M7722/IT-M7721L/IT-M7722L/IT-M7723E

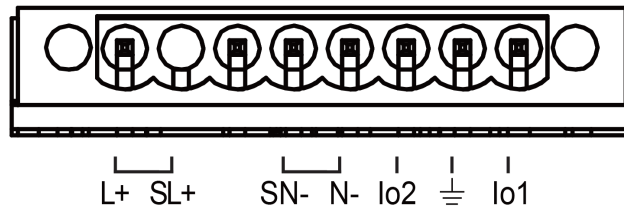

- IT-M7723

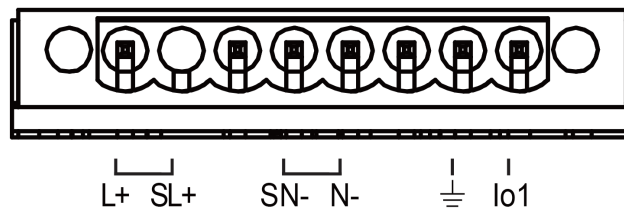

Table 4–3 Description of Digital I/O pin level

Pin	Type	Description
IO1	Digital in	High level voltage range: 5.0V±0.25V, low level voltage range: 0V±0.25V.
	Digital out	High level voltage range: 5.0V±0.25V, The maximum output current of IO1 is 0.5 mA. Low level voltage range: 0V±0.25V.
IO2	Digital in	High level voltage range: 5.0V±0.25V, low level voltage range: 0V±0.25V.
	Digital out	High level voltage range: 5.0V±0.25V, The maximum output current of IO2 is 0.5 mA. Low level voltage range: 0V±0.25V.
GND	Ground	Ground for digital inputs and outputs.

Table 4–4 Description of Digital I/O pin parameter

Ext IO1	Parameter setting for IO1.		
	Off	Turn off the IO1 function.	
	Output	Config IO1 as output pin.	
		L if out on	When the output state of the instrument is On, this pin outputs 0V. When the output state of the instrument is Off, this pin outputs 5V.
		H if out on	When the output state of the instrument is On, this pin outputs 5V. When the output state of the instrument is Off, this pin outputs 0V.
	Input	Config IO1 as input pin.	
		L To out on	When send 0V signal to IO1, the instrument turns on the output. When send 5V signal to IO1, the instrument turns off the output.
	H To out on	When send 5V signal to IO1, the instrument turns on the output. When send 0V	

			signal to IO1, the instrument turns off the output.
Ext IO2	Parameter setting for IO2.		
	Off	Turn off the IO2 function.	
	Output	Config IO2 as output pin.	
		L if out on	When the output state of the instrument is On, this pin outputs 0V. When the output state of the instrument is Off, this pin outputs 5V.
		H if out on	When the output state of the instrument is On, this pin outputs 5V. When the output state of the instrument is Off, this pin outputs 0V.
	Input	Config IO2 as input pin.	
		L To out on	When send 0V signal to IO2, the instrument turns on the output. When send 5V signal to IO2, the instrument turns off the output.
		H To out on	When send 5V signal to IO2, the instrument turns on the output. When send 0V signal to IO2, the instrument turns off the output.

Output On/Off Control

Digital I/O1 and I/O2 can be used to control the power supply output, which is controlled by the high and low level input by this pin. The operation steps are as follows:

1. Config IO2 as input pin.
 - a. Press the composite keys **[Shift] + [I-set]**(Function) to enter function menu interface.
 - b. Rotate the knob to select **Ext IO2** and press **[Enter]** key to confirm.
 - c. Rotate the knob to select **Input** and press **[Enter]** key to config IO2 as input pin.
 - d. Rotate the knob to select **L To out on** or **H To out on** and press **[Enter]** key to confirm.

- **L To out on:** When send 0V signal to IO2, the instrument turns on the output. When send 5V signal to IO2, the instrument turns off the output.
 - **H To out on:** When send 5V signal to IO2, the instrument turns on the output. When send 0V signal to IO2, the instrument turns off the output.
2. There is an external DC voltage source capable of outputting 0V ~ 5V voltage between IO2 and GND to control power output.

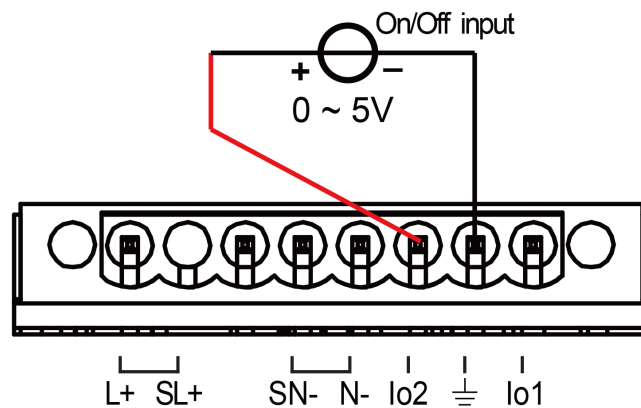

Monitoring of output status

You can connect a standard multi-meter to IO1 and IO2 to monitor the On/Off status of the instrument. The operation steps are as follows:

1. Config IO1 as output pin.
 - a. Press the composite keys **[Shift] + [I-set]**(Function) to enter function menu interface.
 - b. Rotate the knob to select **Ext IO1** and press **[Enter]** key to confirm.
 - c. Rotate the knob to select **Output** and press **[Enter]** key to config IO1 as output pin.
 - d. Rotate the knob to select **L if out on** or **H if out on** and press **[Enter]** key to confirm.
 - **L if out on:** When the output state of the instrument is On, this pin outputs 0V. When the output state of the instrument is Off, this pin outputs 5V.
 - **H if out on:** When the output state of the instrument is On, this pin outputs 5V. When the output state of the instrument is Off, this pin outputs 0V.
2. You can connect a digital voltmeter to IO1 and GND to monitor the On/Off status of the instrument.

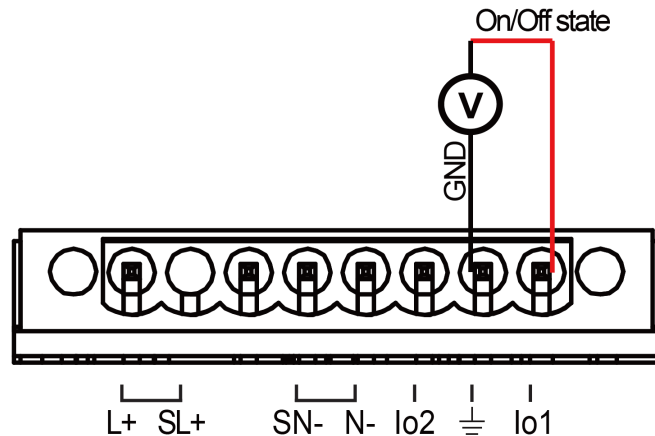

4.9.6 Set the Output Timer Function

You can set the output timer within the range from 10ms to 10000000ms. Once the timer expires, the output is turned off.

The procedures to set the output timer are as follows.

1. Press the composite keys **[Shift] + [I-set]**(Function) to enter function menu interface.
2. Use knob or left and right keys to select **Off Timer** and press **[Enter]** to confirm.
3. Use knob or left and right keys to select **On** to turn the timer function on and press **[Enter]** to confirm.
4. Use knob to adjust the output **Timer** and press **[Enter]** to confirm.
5. Press **[Esc]** to exit the function menu setting.

4.10 Protection Function

4.10.1 Set the Over-Voltage Protection (rms)

The user can set the over-voltage protection point for the over-voltage protection (rms) function. When the output voltage reaches the over-voltage protection point, the over-voltage protection (rms) will turn off the output. The function is mainly used to protect the DUT connected during test to prevent it from damage due to over-voltage. The OVP (rms) function is always enabled.

Set the OVP(rms) point

1. Press the composite keys **[Shift] + [F-set]**(Protect) to enter Protect menu interface.
2. Rotate the knob to select **OVP(rms)** and press **[Enter]** key to confirm.

3. Rotate the knob to adjust the OVP(rms) point and press **[Enter]** key to confirm.
4. Press **[Esc]** to exit the protection menu setting.

Clear OVP(rms) status

When over-voltage protection occurs, the instrument responds as follows:

- The instrument output is turned off, and other keys (except the **[Esc]** key) are locked.
- The buzzer sounds intermittently three times: one long beep and two short beeps.
- The interface displays “OVPrms Occurred!!”;
- Status register, the OVPrms status bit is set to 1.

To clear the over-voltage and return to normal operation, firstly remove the conditions that caused the protection fault. Press **[Esc]** key (or send the command PROTect:CLEar) to clear the protection status. The “OVPrms Occurred!!” displayed in front panel is cleared and the instrument exits OVP(rms) status.

4.10.2 Set the Over-Voltage Protection (peak)

The user can set the over-voltage protection point for the over-voltage protection (peak) function. When the output voltage reaches the over-voltage protection point, the over-voltage protection (peak) will turn off the output. The function is mainly used to protect the DUT connected during test to prevent it from damage due to over-voltage. The OVP (peak) function is always enabled.

Set the OVP(peak) point

1. Press the composite keys **[Shift] + [F-set]**(Protect) to enter Protect menu interface.
2. Rotate the knob to select **OVP(peak)** and press **[Enter]** key to confirm.
3. Rotate the knob to adjust the OVP(peak) point and press **[Enter]** key to confirm.
4. Press **[Esc]** to exit the protection menu setting.

Clear OVP(peak) status

When over-voltage protection occurs, the instrument responds as follows:

- The instrument output is turned off, and other keys (except the **[Esc]** key) are locked.
- The buzzer sounds intermittently three times: one long beep and two short beeps.

- The interface displays “OVPpeak Occurred!!”;
- Status register, the OVPpeak status bit is set to 1.

To clear the over-voltage and return to normal operation, firstly remove the conditions that caused the protection fault. Press **[Esc]** key (or send the command PROTect:CLEar) to clear the protection status. The “OVPpeak Occurred!!” displayed in front panel is cleared and the instrument exits OVP(peak) status.

4.10.3 Set the Under-Voltage Protection (rms)

The user can set the under-voltage protection limit for the under-voltage protection (rms) function. If the output voltage is lower than the under-voltage limit, the under-voltage protection (rms) will turn off the output. The UVP (rms) functions is always enabled.

Set the UVP(rms) limit

1. Press the composite keys **[Shift] + [F-set]**(Protect) to enter Protect menu interface.
2. Rotate the knob to select **UVP(rms)** and press **[Enter]** key to confirm.
3. Rotate the knob to adjust the UVP(rms) limit and press **[Enter]** key to confirm.
4. Press **[Esc]** to exit the protection menu setting.

Clear UVP(rms) status

When under-voltage protection occurs, the instrument responds as follows:

- The instrument output is turned off, and other keys (except the **[Esc]** key) are locked.
- The buzzer sounds intermittently three times: one long beep and two short beeps.
- The interface displays “UVPrms Occurred!!”;
- Status register, the UVPrms status bit is set to 1.

To clear the under-voltage and return to normal operation, firstly remove the conditions that caused the protection fault. Press **[Esc]** key (or send the command PROTect:CLEar) to clear the protection status. The “UVPrms Occurred!!” displayed in front panel is cleared and the instrument exits UVP(rms) status.

4.10.4 Set the Over-Current Protection (rms)

The user can set the over-current protection point for the over-current protection (rms) function. When the output current reaches the over-current protection

point, the over-current protection (rms) will turn off the output. The function is mainly used to protect the DUT connected during test to prevent it from damage due to over-current. The OCP (rms) function is always enabled.

Set the OCP(rms) point

1. Press the composite keys **[Shift] + [F-set]**(Protect) to enter Protect menu interface.
2. Rotate the knob to select **OCP(rms)** and press **[Enter]** key to confirm.
3. Rotate the knob to adjust the OCP(rms) point and press **[Enter]** key to confirm.
4. Press **[Esc]** to exit the protection menu setting.

Set the OCP delay

You can specify an OCP delay to prevent momentary output settings, DUT and status changes from tripping the over-current protection. In most cases these momentary conditions would not be considered an over-current protection fault, and having an OCP condition disable the output when they occur would be a nuisance. Specifying an OCP delay lets the OCP circuit ignore these momentary changes during the specified delay period. Once the OCP delay time has expired and the over-current condition persists, the output will shut down.

1. Press the composite keys **[Shift] + [F-set]**(Protect) to enter Protect menu interface.
2. Rotate the knob to select **OCP Delay** and press **[Enter]** key to confirm.
3. Rotate the knob to adjust the OCP delay time and press **[Enter]** key to confirm.
4. Press **[Esc]** to exit the protection menu setting.

Clear OCP(rms) status

When over-current protection occurs, the instrument responds as follows:

- The instrument output is turned off, and other keys (except the **[Esc]** key) are locked.
- The buzzer sounds intermittently three times: one long beep and two short beeps.
- The interface displays “OCPrms Occurred!!”;
- Status register, the OCPrms status bit is set to 1.

To clear the over-current and return to normal operation, firstly remove the conditions that caused the protection fault. Press **[Esc]** key (or send the command **PROTECT:CLEAR**) to clear the protection status. The “OCPrms Occurred!!” displayed in front panel is cleared and the instrument exits OCP status.

4.10.5 Set the Over-Current Protection (peak)

The user can set the over-current protection point for the over-current protection (peak) function. When the output current reaches the over-current protection point, the over-current protection (peak) will turn off the output. The function is mainly used to protect the DUT connected during test to prevent it from damage due to over-current. The OCP (peak) function is always enabled.

Set the OCP(peak) point

1. Press the composite keys **[Shift] + [F-set]**(Protect) to enter Protect menu interface.
2. Rotate the knob to select **OCP(peak)** and press **[Enter]** key to confirm.
3. Rotate the knob to adjust the OCP(peak) point and press **[Enter]** key to confirm.
4. Press **[Esc]** to exit the protection menu setting.

Set the OCP delay

You can specify an OCP delay to prevent momentary output settings, DUT and status changes from tripping the over-current protection. In most cases these momentary conditions would not be considered an over-current protection fault, and having an OCP condition disable the output when they occur would be a nuisance. Specifying an OCP delay lets the OCP circuit ignore these momentary changes during the specified delay period. Once the OCP delay time has expired and the over-current condition persists, the output will shut down.

1. Press the composite keys **[Shift] + [F-set]**(Protect) to enter Protect menu interface.
2. Rotate the knob to select **OCP Delay** and press **[Enter]** key to confirm.
3. Rotate the knob to adjust the OCP delay time and press **[Enter]** key to confirm.
4. Press **[Esc]** to exit the protection menu setting.

Clear OCP(peak) status

When over-current protection occurs, the instrument responds as follows:

- The instrument output is turned off, and other keys (except the **[Esc]** key) are locked.
- The buzzer sounds intermittently three times: one long beep and two short beeps.
- The interface displays “OCPpeak Occurred!!”;
- Status register, the OCPpeak status bit is set to 1.

To clear the over-current and return to normal operation, firstly remove the conditions that caused the protection fault. Press **[Esc]** key (or send the command PROTEct:CLEar) to clear the protection status. The “OCPpeak Occurred!!” displayed in front panel is cleared and the instrument exits OCP status.

4.10.6 Set the Over-Power Protection

The user can set the over-power protection point for the over-power protection function. When the output power reaches the over-power protection point, the over-power protection will turn off the output. The function is mainly used to protect the DUT connected during test to prevent it from damage due to over-current. The OPP function is always enabled.

Set the OPP point

1. Press the composite keys **[Shift] + [F-set]**(Protect) to enter Protect menu interface.
2. Rotate the knob to select **OPP** and press **[Enter]** key to confirm.
3. Rotate the knob to adjust the OPP point and press **[Enter]** key to confirm.
4. Press **[Esc]** to exit the protection menu setting.

Clear OPP status

When over-power protection occurs, the instrument responds as follows:

- The instrument output is turned off, and other keys (except the **[Esc]** key) are locked.
- The buzzer sounds intermittently three times: one long beep and two short beeps.
- The interface displays “OPP Occurred!!”;
- Status register, the OPP status bit is set to 1.

To clear the over-power and return to normal operation, firstly remove the conditions that caused the protection fault. Press **[Esc]** key (or send the command PROTEct:CLEar) to clear the protection status. The “OPP Occurred!!” displayed in front panel is cleared and the instrument exits OPP status.

4.10.7 Set the Current Limiting Protection

The user can set the current limiting point for the current limiting protection function. If the output current reaches the limiting current protection point, the protection will be activated. The power supply output current is controlled within the current limiting value, and the output is stopped after several milliseconds. The

current limiting protection function can limit the instrument output to prevent the DUT from being damaged. The operation steps are as follows.

1. Press the composite keys **[Shift] + [F-set]**(Protect) to enter Protect menu interface.
2. Rotate the knob to select **MCL** and press **[Enter]** key to confirm.
3. Rotate the knob to adjust the current limiting point, and press **[Enter]** key to confirm.
4. Press **[Esc]** to exit the protection menu setting.



Note

- When the frequency setting is less than or equal to 100Hz, the MCL value can be adjusted; if the frequency setting exceeds 100Hz, the MCL value will be locked at the maximum value. For specific data, please refer to the MCL value in [4.11.6 Restore the as-shipped settings](#).
- The protection action of MCL is controlled by hardware, and the error is within $\pm(1-2)A$.

4.10.8 Set the Sense Check Protection

Sense Check protection is a programmable and settable function by users, which can be enabled or disabled. After this function is enabled, the remote measurement will be checked before instrument output. If the remote sense terminals (SL+, SN-) are inverted, the protection will be activated and the output will be stopped. When this function is disabled, the instrument will not check whether the remote sense terminals have been connected before output.

Set the Sense Check Protection

1. Press the composite keys **[Shift] + [F-set]**(Protect) to enter Protect menu interface.
2. Rotate the knob to select **Sense Check** and press **[Enter]** key to confirm.
3. Rotate the knob to switch **On** and **Off** options. After selecting **On** or **Off**, press **[Enter]** key to confirm.
 - Off: Default value, indicating that the Sense Check protection is disabled.
 - On: indicate that the Sense Check protection is enabled.
4. Press **[Esc]** to exit the protection menu setting.

Clear protection status

When protection occurs, the instrument responds as follows:

- The instrument output is turned off, and other keys (except the **[Esc]** key) are locked.

- The buzzer sounds intermittently three times: one long beep and two short beeps.
- The interface displays “Remote Sense Occurred!!”.

To clear the protection status and return to normal operation, firstly remove the conditions that caused the protection fault. Press **[Esc]** key (or send the command PROTect:CLEar) to clear the protection status. The “Remote Sense Occurred!!” displayed in front panel is cleared and the instrument exits protection status.

4.10.9 Limiting the Setting Value Range

All setting values (Vac, Vdc, Freq, OCPrms) can be adjusted between 0 and 100%. You can reset the upper and lower limits of all setting values in the Protect menu. After setting the limiting values, the setting values of Vac, Vdc, Freq, OCPrms can only be set within the upper and lower limit ranges. The operation steps are as follows.

1. Press the composite keys **[Shift] + [F-set]**(Protect) to enter Protect menu interface.
2. Rotate the knob to select **Range Set** and press **[Enter]** key to confirm.
3. Rotate the knob to switch the display of maximum value/minimum value options of setting values like Vac, Vdc, Freq and OCPrms. Select one item and press **[Enter]** key to confirm.
 - Vac-Max: set the maximum value of the AC voltage setting value.
 - Vac-Min: set the minimum value of the AC voltage setting value.
 - Vdc-Max: set the maximum value of the DC voltage setting value.
 - Vdc-Min: set the minimum value of the DC voltage setting value.
 - Freq-Max: set the maximum value of the frequency setting value.
 - Freq-Min: set the minimum value of the frequency setting value.
 - OCP-Max: set the maximum value of the OCPrms setting value.
 - OCP-Min: set the minimum value of the OCPrms setting value.
4. Rotate the knob to adjust the parameter, and press **[Enter]** key to confirm.
5. Press **[Esc]** to exit the protection menu setting.

4.11 System-Related Operations

4.11.1 Switch Local/Remote Mode

IT-M7700 series power source provide local operation and remote operation. The default mode is local operation mode.

- Local operation mode: use front panel keys to control the power source.
- Remote operation mode: the power source is connected to PC, the user uses the software in PC to control the power source remotely. During remote control operation, the **[Enter]** key on the front panel is lit. All panel keys, except the **[On/Off]** and **[Shift] + [Link]**(Local) keys, are locked. You can press **[Shift] + [Link]**(Local) to switch the remote control to local control. The mode modification will not affect the output parameters.

4.11.2 Save and Recall Operations

IT-M7700 series power source can save up to 10 common parameters in nonvolatile memory (No. 0 to No. 9) for user to recall conveniently. The contents stored in each group include: output mode(AC/DC), voltage setting value(AC), voltage setting value(DC), OCPrms, frequency setting value and phase angle.

Save Operations

1. Press the composite keys **[Shift] +**  (Save) to enter the parameter save interface.

```
110.0V  1.00A  60.0Hz
Save data bank = 0
```

Information description:

- The first line displays the content to be saved, i.e., the real-time setting value.
 - The second line displays the setting value of the saved position.
2. Rotate the knob and input the digits 0~9 to set the saved position.
 3. Press the **[Enter]** key to save the real-time setting value.

Recall Operations

1. Press the composite keys **[Shift] +**  (Recall) to enter the parameter recall interface.

```
5.00V  6.00A DC MODE
Recall data bank = 3
```

Information description:

- The first line displays the content to be recalled
 - The second line displays the setting value of the recalled position.
2. Rotate the knob and input the digits 0~9 to set the recalled position.
 3. Press the **[Enter]** key to call the contents in the memory to use as the real-time setting values.

4.11.3 Key Lock Function

The front panel controls can be locked to protect from accidental power source parameter change. Press the composite keys **[Shift] + [Enter]** (Lock) to lock front panel keys and the **[Enter]** key is lit. All panel keys, except the **[On/Off]** and **[Shift] + [Enter]** (Lock) keys, are locked. You can repress **[Shift] + [Enter]** (Lock) to unlock the front panel.

4.11.4 Set the Beeper Status

This item can set the buzzer state.

Operation Steps:

1. Press the composite keys **[Shift] + [DC]**(System) to enter into the system menu interface.
2. Rotate the knob to select **Beep** and press **[Enter]** key to confirm.
3. Rotate the knob to switch **On** and **Off** options. After selecting **On** or **Off**, press **[Enter]** key to confirm.
 - On: default value, indicates the beeper is on.
 - Off: indicates the beeper is off.
4. Press **[Esc]** to exit the system menu setting.

At this point, the beeper sound operation immediately becomes valid.

4.11.5 Set the Power-on State

This menu item is used to control the settings and output state when the power source is powered on. The detailed power-on parameters and output state are as follows.

- Output mode(AC/DC), AC voltage setting value, DC voltage setting value, OCPrms and frequency setting value.
- The output state of the power source, i.e., the **[On/Off]** key state.

Operation Steps:

1. Press the composite keys **[Shift] + [DC]**(System) to enter into the system menu interface.

2. Rotate the knob to select **PowerOn** and press **[Enter]** key to confirm.
3. Rotate the knob to set the power-on state and press **[Enter]** key to confirm.
 - Reset: default value, indicates that the power source recalls the fixed settings at power-on. For details about the fixed settings of the instrument are as shown in the following table.

Table 4–5 Fixed value of the parameter

Parameter	Fixed Value
Vac	50V
Vdc	0V
OCP	Max
Freq	50.0Hz
AC + DC	Off
Output Mode	AC
[On/Off] status	Off

- Last: indicates when powered on, the power source will remain the same settings and output state as last time you turned off the power source.
 - Last+Off: indicates when powered on, the power source will remain the same settings as last time you turned off the power source, but the output state is Off state.
4. Press **[Esc]** to exit the system menu setting.

4.11.6 Restore the as-shipped settings

This menu item is used to restore the as-shipped settings. The procedures to set the menu item are as follows.

1. Press the composite keys **[Shift] + [DC]**(System) to enter into the system menu interface.
2. Rotate the knob to select **System Reset** and press **[Enter]** key to confirm.
3. Rotate the knob to switch **Yes** and **No** options. After selecting **Yes** or **No**, press **[Enter]** key to confirm.
 - No: default value, indicates the power source cancels this menu setting.
 - Yes: indicates the power source restores the as-shipped settings.
4. Press **[Esc]** to exit the system menu setting.

Table 4–6 The as-shipped settings

Parameter	Factory default value
Source	
Vac	50V
Vdc	0V
OCP	<ul style="list-style-type: none"> • IT-M7721L/IT-M7721: 3A • IT-M7722L/IT-M7722: 6A • IT-M7723(V Range = High): 6A • IT-M7723(V Range = Low): 12A • IT-M7723E: 15A
Freq	50.0Hz
Config menu	
I Range	Auto (IT-M7721L/IT-M7722L/IT-M7723 does not support this function.)
AC + DC	Off
On Phase	0.0°
Off Phase	0.0°
V-Rise Time	1ms
Wave	Sine (IT-M7721L/IT-M7722L does not support this function.)
Parallel	Single(Only IT-M7721/IT-M7722/IT-M7723E support this function.)
Channel Number	1(Only IT-M7723 support this function.)
System menu	
Beep	On
PowerOn	Last+Off
CAN Address	1
CAN Baudrate	500K
IP Mode	Auto
IP	192.168.0.2
Gate	192.168.0.1

Parameter	Factory default value
Mask	255.255.255.0
DNS1	0.0.0.0
DNS2	0.0.0.0
Port	30000
GPIB Address	1
RS232 Baudrate	115200
Relay Ctrl	Out Syn
System Reset	No
Protect menu	
OVP(rms)	<ul style="list-style-type: none"> • IT-M7723 V Range High: 880V • IT-M7721L/IT-M7721: 440V • IT-M7722L/IT-M7722: 440V • IT-M7723(V Range = Low): 440V • IT-M7723E: 440V
OVP(peak)	<ul style="list-style-type: none"> • IT-M7723 V Range High: 880V • IT-M7721L/IT-M7721: 440V • IT-M7722L/IT-M7722: 440V • IT-M7723(V Range = Low): 440V • IT-M7723E: 440V
UVP(rms)	0.0V
OCP(rms)	<ul style="list-style-type: none"> • IT-M7721L/IT-M7721: 3A • IT-M7722L/IT-M7722: 6A • IT-M7723(V Range = High): 6A • IT-M7723(V Range = Low): 12A • IT-M7723E: 15A
OCP(peak)	<ul style="list-style-type: none"> • IT-M7721L/IT-M7722L: 10A • IT-M7721/IT-M7722: 20A • IT-M7723(V Range = High): 20A • IT-M7723(V Range = Low): 40A • IT-M7723E: 50A

Parameter	Factory default value
OCP delay	50ms
OPP	<ul style="list-style-type: none"> • IT-M7721L/IT-M7721: 300VA • IT-M7722L/IT-M7722: 600VA • IT-M7723: 1200VA • IT-M7723E: 1500VA
MCL	<ul style="list-style-type: none"> • IT-M7721L/IT-M7721: 20A • IT-M7722L/IT-M7722: 20A • IT-M7723(V Range = High): 20A • IT-M7723(V Range = IOW): 40A • IT-M7723E: 50A
Sense Check	Off
Vac-Max	<ul style="list-style-type: none"> • IT-M7721L/IT-M7721: 300V • IT-M7722L/IT-M7722: 300V • IT-M7723(V Range = High): 600V • IT-M7723(V Range = IOW): 300V • IT-M7723E: 300V
Vac-Min	0.0V
Vdc-Max	<ul style="list-style-type: none"> • IT-M7721L/IT-M7721: 400V • IT-M7722L/IT-M7722: 400V • IT-M7723(V Range = High): 800V • IT-M7723(V Range = IOW): 400V • IT-M7723E: 400V
Vdc-Min	<ul style="list-style-type: none"> • IT-M7721L/IT-M7721: - 400V • IT-M7722L/IT-M7722: - 400V • IT-M7723(V Range = High): - 800V • IT-M7723(V Range = IOW): - 400V • IT-M7723E: - 400V
Freq-Max	<ul style="list-style-type: none"> • IT-M7721L/IT-M7722L: 100Hz • IT-M7721/IT-M7722: 1000Hz • IT-M7723/IT-M7723E: 1000Hz

Parameter	Factory default value
Freq-Min	45.0Hz
	<ul style="list-style-type: none"> IT-M7721L/IT-M7721: 3.15A IT-M7722L/IT-M7722: 6.3A IT-M7723(V Range = High): 6.3A IT-M772(V Range = IOW) 12.6A
OCP-Max	<ul style="list-style-type: none"> IT-M7723E: 15.75A
OCP-Min	0.00A
Function menu (IT-M7721L/IT-M7722L does not support this function.)	
List Mode	Off
List Trigger	Off
Dimmer	Off
Surge Trap	Off
Ext IO1	Off
Ext IO2	Off (IT-M7723 does not support this function.)
Off Timer	Off

4.11.7 View the System Information

This menu item is used to view the system information of the instrument. The procedures to view the system information are as follows.

1. Press the composite keys **[Shift] + [DC]**(System) to enter into the system menu interface.
2. Rotate the knob to select **System Info** and press **[Enter]** key to confirm.
3. Rotate the knob to page up and down and check the instrument system information. Specific parameters are shown in the table below:

Name	Description
Manufacturer	Display the manufacturer's name.
Model	Display the instrument model.
Version	Display the software version.
Serial Number	Display the serial number.

Name	Description
SCPI Error	Display SCPI command error information.
Last Cal. Date	Display last calibration date.
Master Fan	Master power board fan speed rpm.
Master NTC	Master power plate temperature sensor parameters (negative temperature coefficient).
Slave Fan	IT-M7723 slave power board fan speed rpm.
Slave NTC	IT-M7723 slave power plate temperature sensor parameters (negative temperature coefficient).

4. Press **[Esc]** to exit the system menu setting.

4.11.8 Set the Relay Control

The power output has a built-in relay used for connecting the load, which can realize electrical isolation between the power end and the load end.

- When the output relay is set to **NC**, it indicates that the relay will be normally closed in regardless of whether the power supply's output status is Off or not, i.e., accessing to the load circuit.
- When the output relay is set to **Out Syn**, it indicates that the relay will be closed only when the output status is On; if the output status is Off, the output relay will be open, i.e., isolating the load circuit.

Operation Steps:

1. Press the composite keys **[Shift] + [DC]**(System) to enter into the system menu interface.
2. Rotate the knob to select **Relay Ctrl** and press **[Enter]** key to confirm.
3. Rotate the knob to switch **Out Syn** and **NC** options. After selecting **Out Syn** or **NC**, press **[Enter]** key to confirm.
 - Out Syn: The relay is linked with Output. When the instrument output is On, the relay is closed; when the instrument output is Off, the relay is open, and the instrument and the load are electrically separated.
 - NC: The relay is normally closed. Whether the instrument out is On or Off will not affect the operation of relay.
4. Press **[Esc]** to exit the system menu setting.

Note

When the DUT is a resistive load, it is recommended to select the NC option, so that the output speed response is fast and the life of the relay can also be prolonged. For safety reasons, when the DUT is other types of loads, you need to select the Out Syn option.

4.12 External Analog Quantity Function (Option)

IT-M7700 series power supply provides a optional DB25 analog interface(IT-E1208). The analog interface provides the following capability:

- Remote control of output voltage and current.
- Remote control of output On/Off state.
- Remote monitoring of output voltage/current measurement and AC/DC mode.
- Clear the instrument error status.
- Remote monitoring of output On/Off state, load status and error status.

4.12.1 Definition of Analog Interface

Analog signal bandwidth is less than 100 Hz, supports any waveform within signal bandwidth. When the program signal frequency or amplitude exceeds output capacity, the output amplitude will be automatically limited. The definitions and descriptions for analog interface are as follows. The accuracy of the analog function (input or output) is $\leq \pm 1\%FS$.

Figure 4–1 DB25 Analog Interface

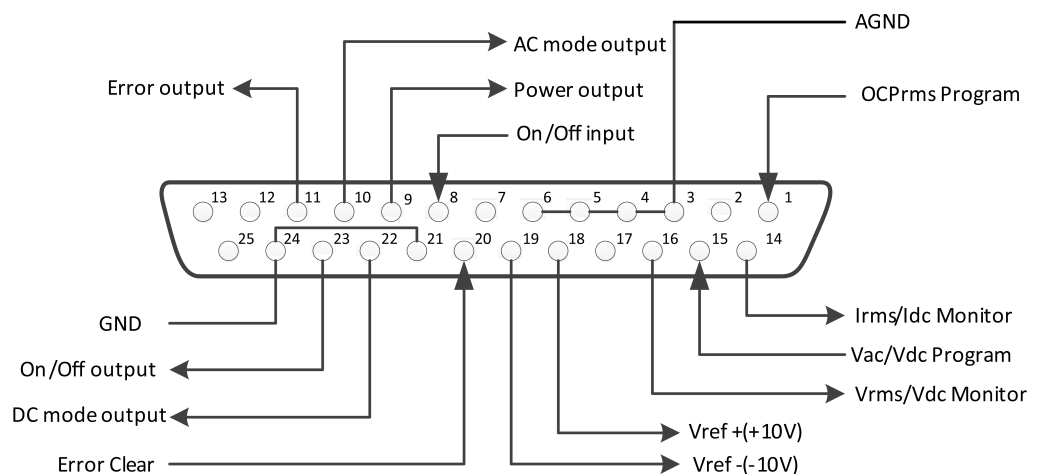

Table 4–7 Description of DB25 Analog Interface

Pin	Name	Type	Description
1	OCPrms Program	Analog in	Programs OCPrms.
2/7/12/ 13/17/ 25	Not used	-	-
3/4/5/6	AGND	Ground	Ground for analog inputs and outputs.
8	On/Off input	Digital in	Receives the signal that is used to turn the output on or off.
9	Power output	Digital out	Sends the signal that is used to indicate whether the output status is normal or not.
10	AC mode output	Digital out	AC output status indicator. High when in AC mode.
11	Error output	Digital out	Sends the signal that is used to indicate whether the power supply errors or not.
14	Irms/Idc Monitor	Analog out	Current monitor signal.
15	Vac/Vdc Program	Analog in	Programs output voltage.
16	Vrms/Vdc Monitor	Analog out	Voltage monitor signal.
18	Vref+	Analog out	The +10Vdc/10mA reference voltage output by the power supply can be connected to a resistance subdivision for analog control.
19	Vref-	Analog out	The -10Vdc/10mA reference voltage output by the power supply can be connected to a resistance subdivision for analog control.
20	Error Clear	Digital in	Signal input for clearing the instrument error.

Pin	Name	Type	Description
21/24	GND	Ground	Ground for digital inputs and outputs.
22	DC mode output	Digital out	DC output status indicator. High when in DC mode.
23	On/Off output	Digital out	Signal output for indicating the output On/Off status of the power supply.

CAUTION

- **Before connecting the hardware device that controls the analog interface, make sure that the hardware device does not output a voltage higher than 20% of the specified value to the pin, otherwise the instrument will be damaged. For example, when setting the voltage or current, the input voltage can't exceed 12V, otherwise the instrument will be damaged.**
- **In analog remote control mode, the analog signal input pin cannot be left floating. Before enabling the external analog function, verify that pin 1 (OCPrms Program) and pin 15 (Vac/Vdc Program) are connected correctly.**
- **Safe electrical isolation is set between this analog interface and output electrode. Do not connect any ground wire of the analog interface to the positive and negative terminals of the output interface.**

4.12.2 Enable/Disable Analog Control

To use the external analog control function, you must enable the analog control in the system menu. The setting steps are as follows:

1. Correctly install the IT-E1208 optional card. For details, refer to [2.5 Connecting the Interface](#).
2. Correctly connect the Pin 1 (OCPrms Program) and Pin 15 (Vac/Vdc Program): Connect an external DC voltage source capable of outputting 0V ~ 10V voltage between Pin 1 and Pin 3 and between Pin 15 and Pin 4

respectively, as shown below.

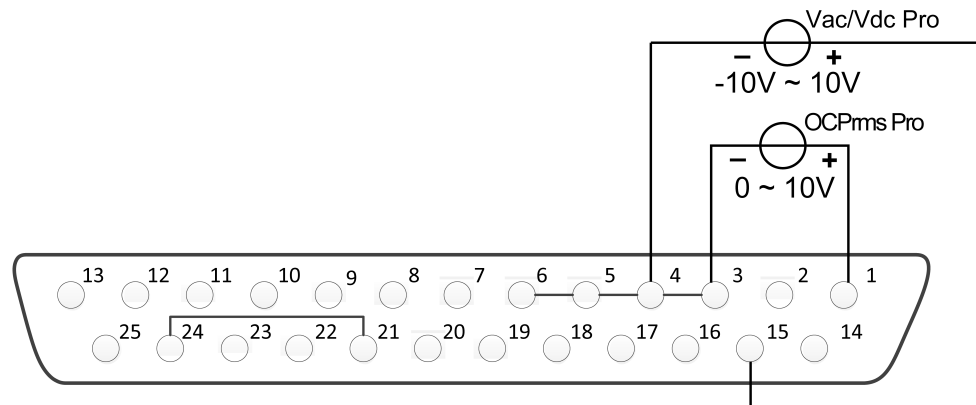

3. Enable/disable analog quantity function.
 - a. Press the composite keys **[Shift] + [DC]**(System) to enter into the system menu interface.
 - b. Rotate the knob to select **I/O Advance Config** and press **[Enter]** key to confirm.
 - c. Rotate the knob to select **Local/Analog** and press **[Enter]** key to confirm.
 - d. Rotate the knob to switch **Local** and **Analog** options. After selecting **Local** or **Analog**, press **[Enter]** key to confirm.
 - Local: Default value, indicating that the voltage and current setting values are controlled by the front panel, and the DB25 device does not receive input or output.
 - Analog: indicate that the **[V-set]** and **[I-set]** keys on the front panel are invalid, and the voltage and current setting values are controlled by the DB25 device.
 - e. Press **[Esc]** to exit the system menu setting.

4.12.3 Analog Quantity Control

Output On/Off Control

Pin 8(On/Off input) can be used to control the power supply output, which is controlled by the trigger signal input by this pin. The falling time or rising time of the trigger signal controls the output. The operation steps are as follows:

1. Enable the analog control. For details, refer to [4.12.2 Enable/Disable Analog Control](#).
2. Select the slope of the trigger signal: rising time or falling time.
 - a. Press the composite keys **[Shift] + [DC]**(System) to enter into the system menu interface.
 - b. Rotate the knob to select **I/O Advance Config** and press **[Enter]** key to confirm.

- c. Rotate the knob to select **Ext In Edge** and press **[Enter]** key to confirm.
 - d. Rotate the knob to switch **Hi/Act** and **Lo/Act** options. After selecting **Hi/Act** or **Lo/Act**, press **[Enter]** key to confirm.
 - Hi/Act: default value, indicating that the rising edge trigger is selected. If the Pin 8 input signal is from 0V to 5V, the power output state switches once.
 - Lo/Act: indicate that the descending edge trigger is selected. If the Pin 8 input signal is from 5V to 0V, the power output state switches once.
 - e. Press **[Esc]** to exit the system menu setting.
3. There is an external DC voltage source capable of outputting 0V ~ 5V voltage between Pin 8 and Pin 24 of the DB25 interface to control power output.

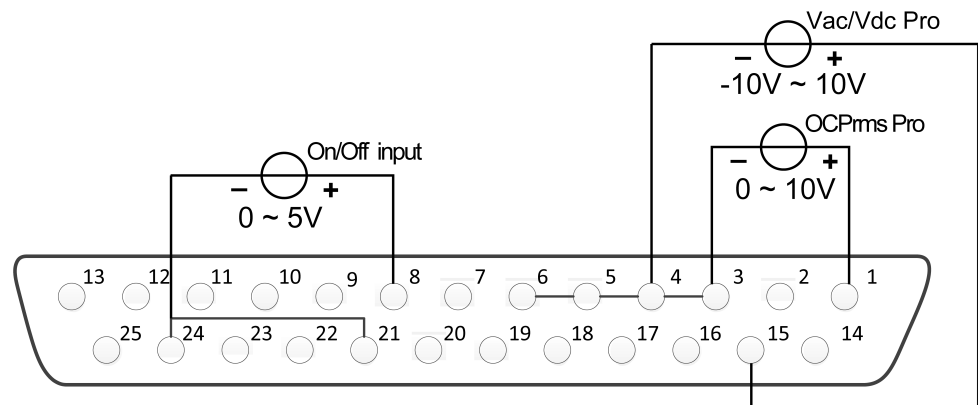

Analog Programming of Voltage and Current

This function can remotely change the voltage and current settings by sending an external analog signal. The connection diagram is as follows:

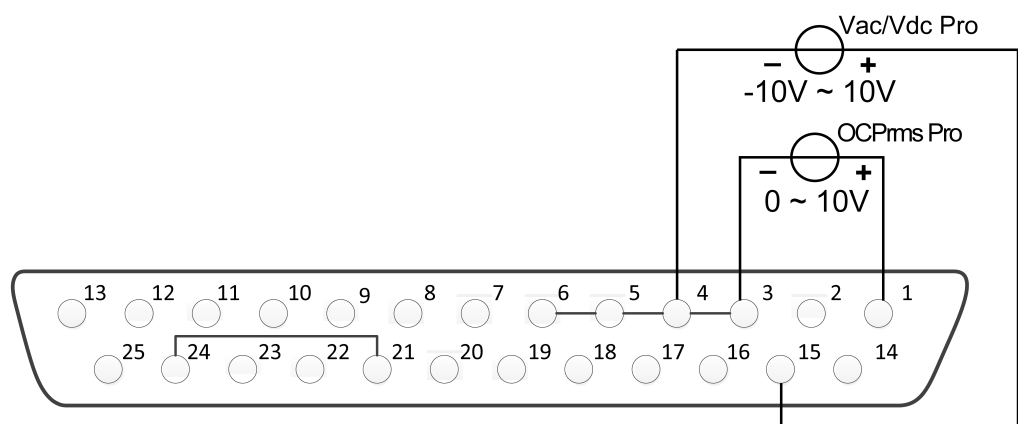

- AC Mode
 - Voltage setting: Analog control of the output voltage can be accomplished by connecting external DC voltage sources in the range of 0 V to 10 V to the 15 and 4 pins.

- Current setting: Analog control of the output current can be accomplished by connecting external DC voltage sources in the range of 0 V to 10 V to the 1 and 3 pins.

By connecting a voltage source to the Vac Pro or OCPrms Pro pins, a voltage setting from 0 to + 10 V corresponds to the zero to full-scale voltage or current setting of the power supply.

For example, if the maximum rated value is 300 V, and if the voltage source is set to 5 V, the setting voltage should be approximately 150 V. If the maximum rated value is 6 A, and if the voltage source is set to 5 V, the setting current should be approximately 3 A.

- DC Mode

- Voltage setting: Analog control of the output voltage can be accomplished by connecting external DC voltage sources in the range of -10 V to 10 V to the 15 and 4 pins.
- Current setting: Analog control of the output current can be accomplished by connecting external DC voltage sources in the range of 0 V to 10 V to the 1 and 3 pins.

By connecting a voltage source to the Vac Pro or OCPrms Pro pins, a voltage setting from - 10 V to + 10 V or 0 to + 10 V corresponds to the zero to full-scale voltage or current setting of the power supply.

For example, if the rated value ranges from - 400 V to + 400 V , and if the voltage source is set to -5 V, the setting voltage should be approximately -200 V. If the maximum rated value is 6 A, and if the voltage source is set to 5 V, the setting current should be approximately 3 A.

Analog Monitoring of Voltage and Current

This function can monitor and read the output voltage and current values. The connection diagram is as follows:

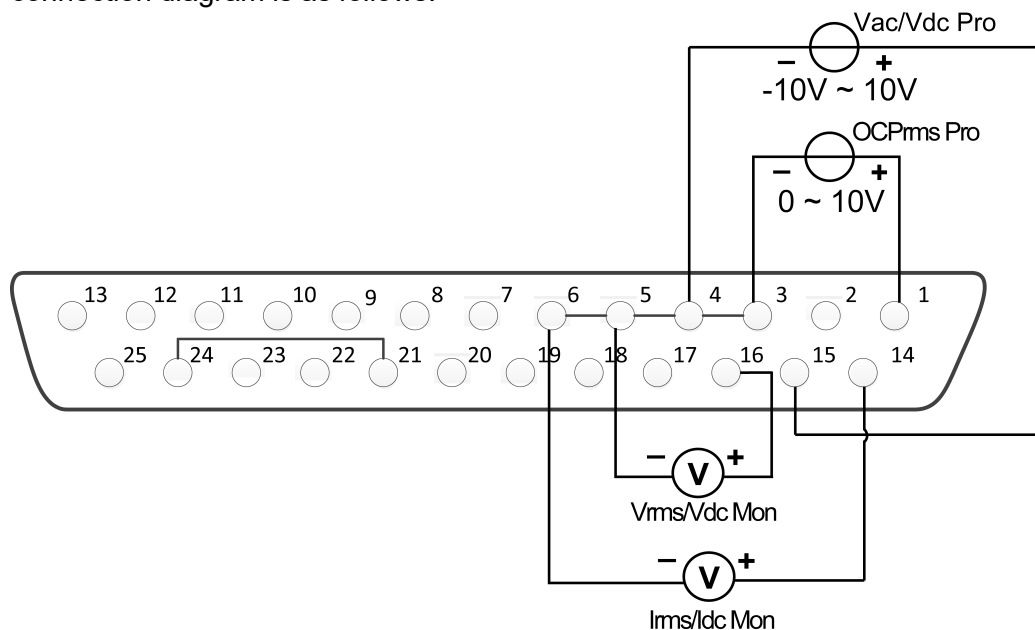

- Current monitoring: Output voltage values can be monitored and read by connecting a digital voltmeter to the 14 and 6 pins.

- Voltage monitoring: Output current values can be monitored and read by connecting a digital voltmeter to the 16 and 5 pins.

By connecting a digital voltmeter to the Vrms/Vdc Monitor or Irms/Idc Monitor pins, a voltage reading from 0 to + 10 V corresponds to the zero to full-scale voltage or current output of the power supply.

For example, if the maximum rated value is 300 V, and if the pin 16 generates 2.5 V, the output voltage should be approximately 75 V. If the maximum rated value is 6 A, and if the pin 14 generates 1 V, the output current should be approximately 0.6 A.

Monitoring of output status

You can connect a standard multi-meter to a pin with appropriate status to monitor the output mode, loaded status and On/Off status of the instrument. The connection diagram is as follows:

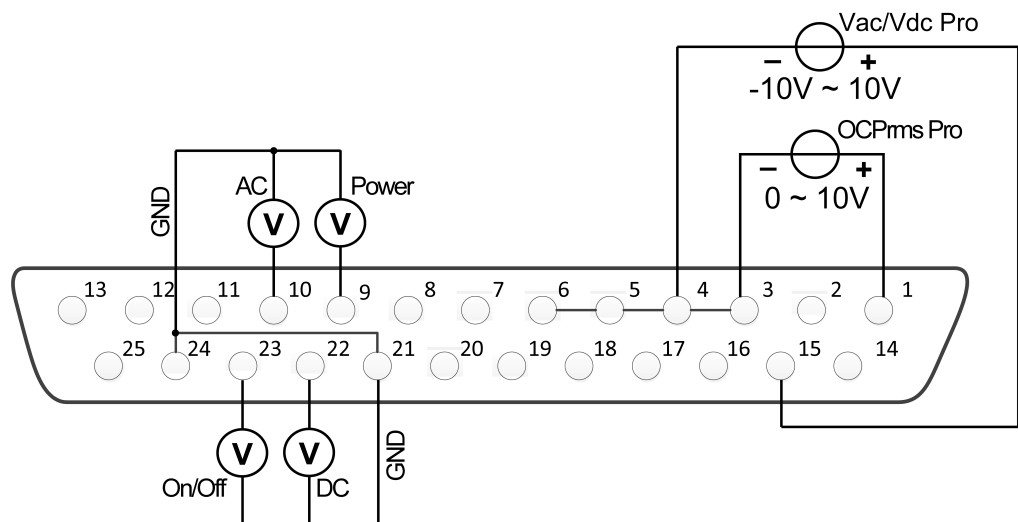

- Monitor the AC output mode: When Pin 10 outputs 5V, it indicates that the instrument is in the AC mode; otherwise, Pin 10 will output 0V.
- Monitor the DC output mode: When Pin 22 outputs 5V, it indicates that the instrument is in the DC mode; otherwise, Pin 22 will output 0V.
- Monitor the instrument load status: If the instrument is under normal loading status, Pin 9 will output 5V; if the instrument is in unloaded status, Pin 9 will output 0V.
- Monitor the instrument On/Off status: When the instrument is On, Pin 23 will output 5V; when the instrument is Off, Pin 23 will output 0V.

Monitor and Clear Error Status

This function can monitor and clear the instrument error status. The connection diagram is as follows:

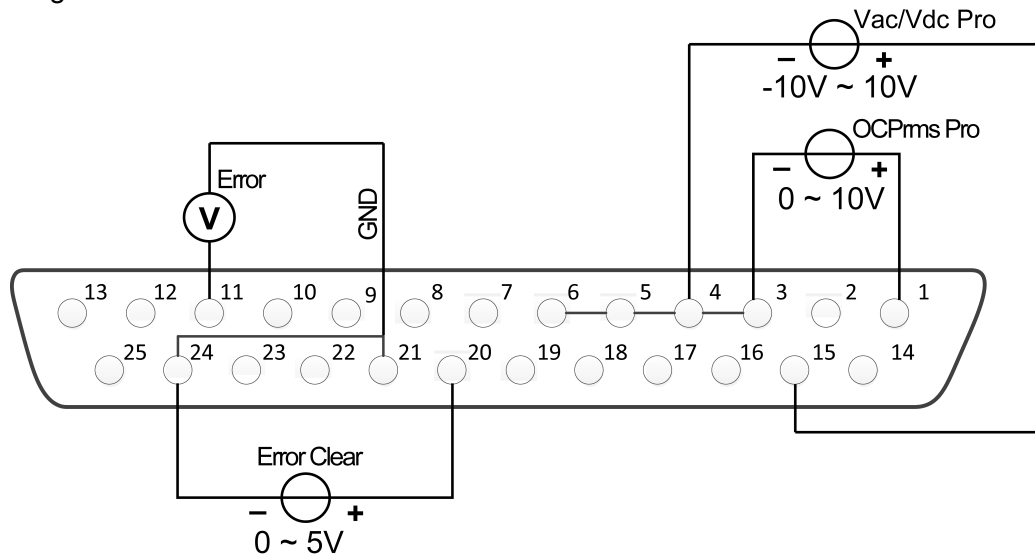

- Monitor instrument error status: if the instrument occurs error status (Over OVPrms or OVPpeak or UVPrms or OCPrms or OCPpeak or Over temperature or Fan Error), Pin 11 will output 5V; if the instrument is in a non-error status, Pin 11 will output 0V.
- Clear instrument error status: when Ext In Edge = Hi/Act, if Pin 20 input is from 0V to 5V, the error status indicated by Pin 11 will be cleared; when Ext In Edge = Lo/Act, if Pin 20 input is from 5V to 0V, the error status indicated by Pin 11 will be cleared.

4.12.4 Calibrate external voltage control

The method of external voltage control calibration is as follows.

1. Please refer to the figure below for connection of the instrument under calibration.

By connecting a digital voltmeter to the 15, 16 and 6 pins.

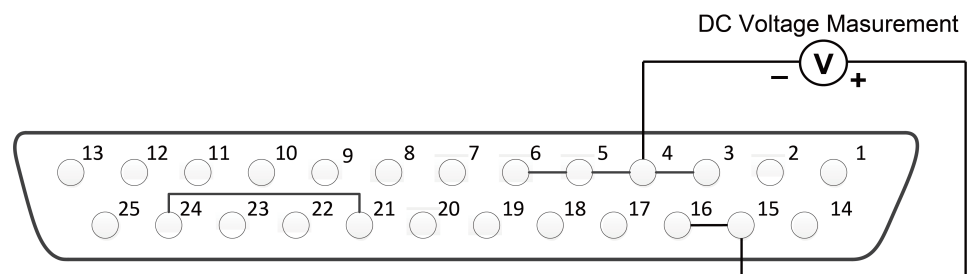

2. Enter calibration mode.
 - a. Press the composite keys **[Shift] + [DC]**(System) to enter into the system menu interface.

- b. Rotate the knob to select **I/O Advance Config** and press **[Enter]** key to confirm.
 - c. Rotate the knob to select **External Cal** and press **[Enter]** key to confirm.
3. External voltage calibration.

- a. On "PT 1" input the voltage value which is the first point showed on the Voltage Meter, and press **[Enter]** key to confirm.

```
VSET    1.000V  DA:  384
PT 1 AD:15500 M   1.003V
```

- b. On "PT 2" input the voltage value which is the second point showed on the Voltage Meter, and press **[Enter]** key to confirm.

```
VSET    9.000V  DA: 3456
PT 2 AD:28500 M   9.070V
```

Finish the external voltage calibration and enter the external current calibration interface.

4. External current calibration.

- a. Please refer to the figure below for connection of the instrument under calibration.

By connecting a digital voltmeter to the 1, 14 and 6 pins.

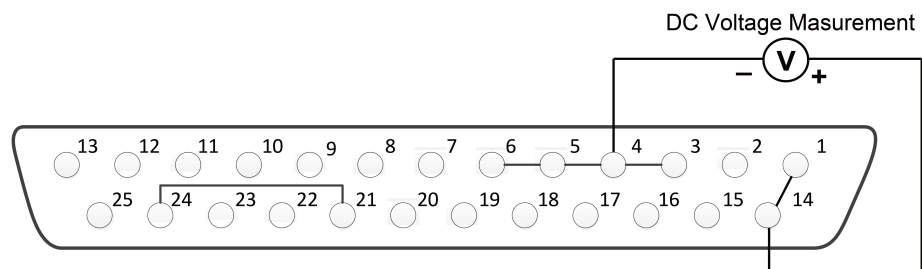

- b. On "PT 1" input the voltage value which is the first point showed on the Voltage Meter, and press **[Enter]** key to confirm.

```
ISET    1.000V  DA:  345
PT 1 AD:16500 M   1.070V
```

- c. On "PT 2" input the voltage value which is the second point showed on the Voltage Meter, and press **[Enter]** key to confirm.

```
ISET    9.000V  DA: 3456
PT 2 AD:28500 M   9.070V
```

Finish the external current calibration.

5 Multi-units operation

- ◆ Series Operation
- ◆ Three-phase Operation
- ◆ Multi-Channel Function

5.1 Series Operation

IT-M7721/IT-M7722/IT-M7723E power supply support series operation, series connection can be applied between same models to increase output power and output voltage, but it can't be applied between different models. IT-M7721/IT-M7722 power supply supports up to two power supplies in series.

For example, the output specification of IT-M7721 is 300V/1A/300VA, then the total output after series is 600V/1A/600VA, the output power and output voltage are both double. This chapter takes two IT-M7721 power supply as an example to describe how to series the single units and how to return from series mode to single mode.

Operation steps

1. Connect the instruments according to the following diagram.
 - Local sense

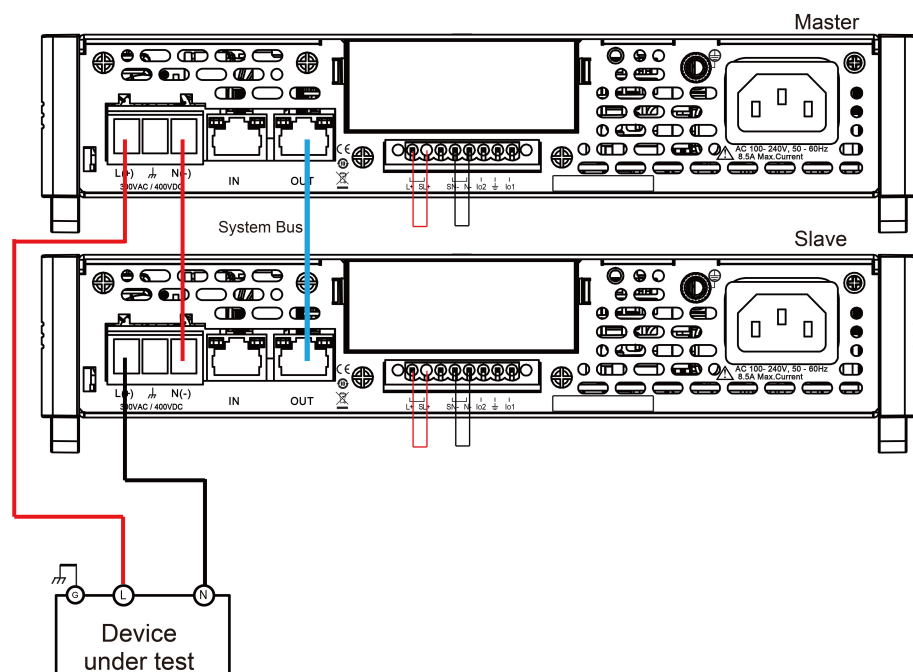

- Remote sense

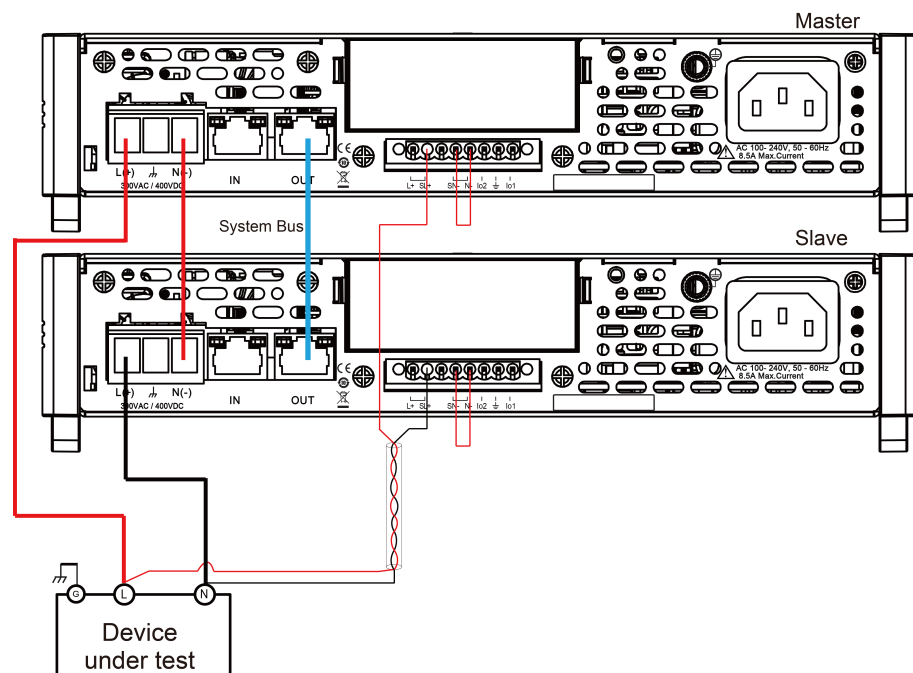

- Use standard network cables to connect System Bus terminals.
 - Connect the AC output terminals of the two units in series and connect them to the DUT.
 - Connect the power cords of 2 stand-alone units, please refer to [2.3 Connecting the Power Cord](#) for details.
- Set two units as master 1 and slave 2 respectively.
 - Press the composite keys **[Shift]+[V-set]**(Config) to enter into the configuration menu interface.
 - Rotate the knob to select **Parallel** and press **[Enter]** key to confirm.
 - Rotate the knob to select “**600V/1A**” and press **[Enter]** key to confirm.
 - Set the **600V/1A Role** menu items of the two units to 1 and 2, respectively, and press **[Enter]** to confirm.
 - 600V/1A Role = 1, it means this unit is the master 1.
 - 600V/1A Role = 2, it means this unit is the slave 2.



Note

In series mode, the phase difference between the two power supplies is fixed at 180 degree and cannot be changed.

- Connect two tandem units online.

Press the **[Link]** button on the front panel of the master A to connect the two synchronous data. After the synchronization is complete, the **[Link]** indicators of the master A and slave B will light up one after another. Press the **[Link]** key on the front panel of the master A again to cancel the synchronization, and the **[Link]** lights of both power supplies will lights off.

- Set the series output.

Please refer to [3.3 Applying Waveform Output](#) to set the series output. When setting, just set the data of master A, slave B will automatically synchronize the data of A. The details of the data that can be synchronized are shown in the following table:

Vac	[V-set]	Sets the output voltage value.
OCPrms	[I-set]	Sets the OCPrms value.
Freq	[F-set]	Sets the frequency value.
On or Off	[On/Off]	Turns the instrument output on or off.
Protect	Protection function	
	1:OVP(rms)	Over-voltage protection(rms)
	2:OVP (peak)	Over-voltage protection(peak)
	3:UVP(rms)	Under-voltage protection(rms)
	4:OCP(rms)	Over-current protection(rms)
	5:OCP (peak)	Over-current protection(peak)
	6:OCP Delay	OCP delay
	7:OPP	Over-power protection
	8:MCL	Current limiting protection
	10:Range Set	Setting value range
		1:Vac-Max
		2:Vac-Min
		5:Freq-Max
		6:Freq-Min
		7:OCP-Max
		8:OCP-Min
Config	Config function	
	1:I Range	Set the current measurement range.
	3:On Phase	Set the starting phase angle of the waveform.
	4:Off Phase	Set the ending phase angle of the waveform.
System	System function	
	5:Relay Ctrl	Set the relay control.

Revert to single mode

1. Press the **[Link]** key on the front panel of master A to cancel the serial synchronization.
2. Set each of the two instruments to single mode.
 - a. Press the composite keys **[Shift]+[V-set]**(Config) to enter into the configuration menu interface.
 - b. Rotate the knob to select **Parallel** and press **[Enter]** key to confirm.
 - c. Rotate the knob to select **Single** and press **[Enter]** key to confirm.
3. Power off the two instruments and disconnect the power cord.
4. Remove the cables connection of the System Bus and AC output terminals between two units.
5. Power on the two instruments separately. After the instrument is restarted, the VFD shows that the instrument is working in single mode.



Note

In series operation, the output waveform only supports Sine waveform.

5.2 Three-phase Operation

Three AC sources can be combined to provide three-phase AC power when required. IT-M7721/IT-M7722/IT-M7723E supports 3-phase output via three units. The three units need to be connected together via System Bus to achieve 3-phase output function of AC power supply. This chapter takes three IT-M7721 power supply as an example to describe how to realize 3-phase in a single units and how to return from 3-phase mode to single mode.

Operation steps

1. Connect the instruments according to the following diagram.
 - Local sense

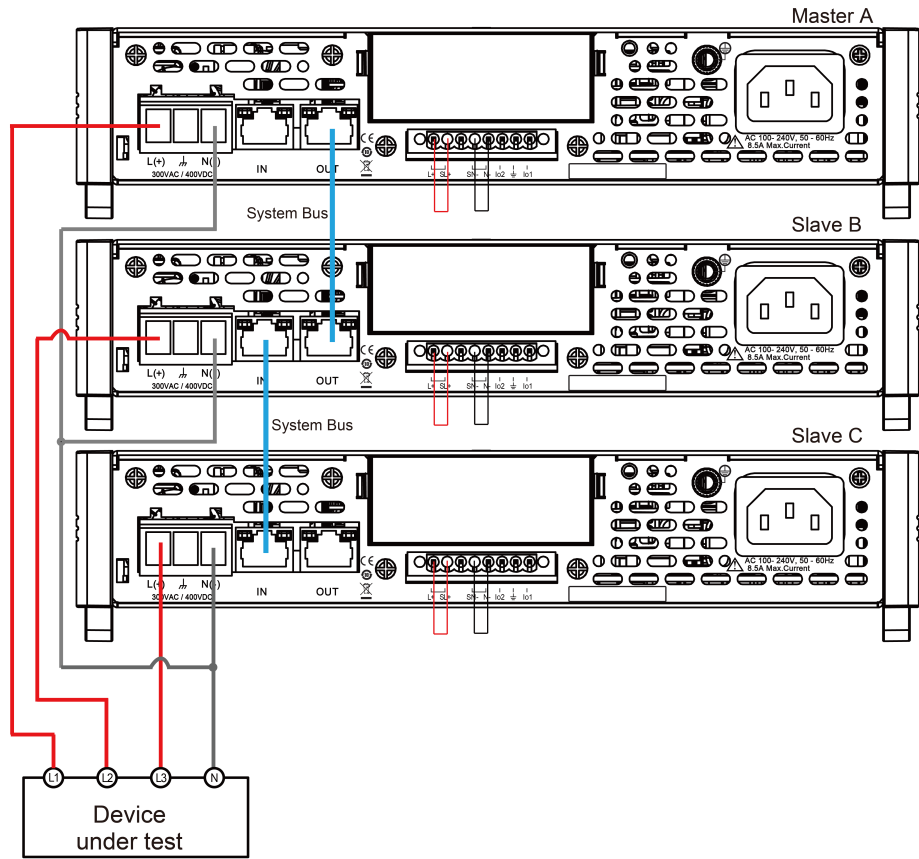

- Remote sense

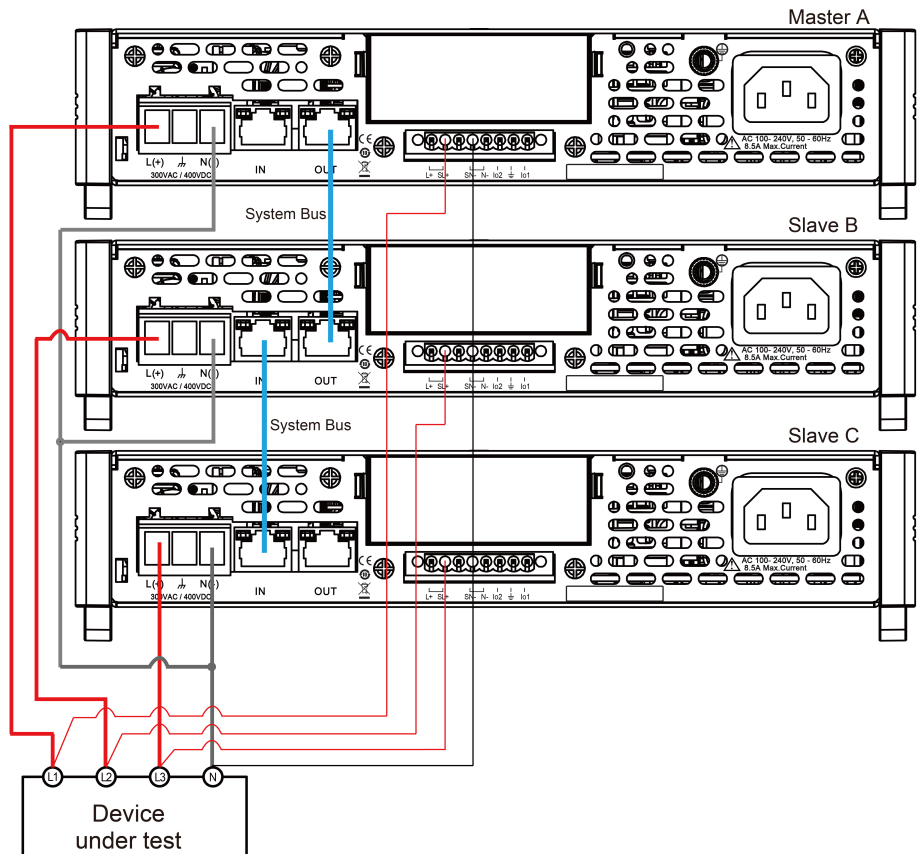

- a. Use standard network cables to connect System Bus terminals.
 - b. Connect the AC output terminals of the three units in three-phase and connect them to the DUT.
 - c. Connect the power cords of 3 stand-alone units, please refer to [2.3 Connecting the Power Cord](#) for details.
2. Set 3 single units as phase A, phase B and phase C respectively.
 - a. Press the composite keys **[Shift]+[V-set]**(Config) to enter into the configuration menu interface.
 - b. Rotate the knob to select **Parallel** and press **[Enter]** key to confirm.
 - c. Rotate the knob to select **3 Phase** and press **[Enter]** key to confirm.
 - d. Set the **3 Phase Role** menu items of 3 units to A, B and C, and press **[Enter]** to confirm.
 - 3 Phase Role = A, it means this unit is the master A.
 - 3 Phase Role = B, it means this unit is the slave B.
 - 3 Phase Role = C, it means this unit is the slave C.
 - e. Set the **Degree** menu items of 3 units to 0.0 degree, 120.0 degree and 240.0 degree, and press **[Enter]** to confirm.
 - Degree = 0.0° (Fixed value), it means this unit is the master A.
 - Degree = 120.0°, it means the slave B is 120 degree ahead of the master A.
 - Degree = 240.0°, it means the slave C is 240 degree ahead of the master A.

In 3-phase mode, the default phase difference between each two power supplies is 120.0 degree, and the phase difference between each two power supplies cannot be less than 5 degree.

3. Connect three three-phase units.

Press the **[Link]** button on the front panel of the master A to connect the three synchronous data. After the synchronization is complete, the **[Link]** indicators of the master A, slave B and slave C will light up one after another. Press the **[Link]** key on the front panel of the master A again to cancel the synchronization, and the **[Link]** lights of three power supplies will lights off.

4. Set the three-phase output.

Please refer to [3.3 Applying Waveform Output](#) to set the three-phase output. When setting, just set the data of master A, slave B and slave C will automatically synchronize the data of A. The details of the data that can be synchronized are shown in the following table:

Vac	[V-set]	Sets the output voltage value.
OCPrms	[I-set]	Sets the OCPrms value.
Freq	[F-set]	Sets the frequency value.
On or Off	[On/Off]	Turns the instrument output on or off.
Protect	Protection function	

	1:OVP(rms)	Over-voltage protection(rms)
	2:OVP (peak)	Over-voltage protection(peak)
	3:UVP(rms)	Under-voltage protection(rms)
	4:OCP(rms)	Over-current protection(rms)
	5:OCP (peak)	Over-current protection(peak)
	6:OCP Delay	OCP delay
	7:OPP	Over-power protection
	8:MCL	Current limiting protection
	10:Range Set	Setting value range
		1:Vac-Max
		2:Vac-Min
		5:Freq-Max
		6:Freq-Min
		7:OCP-Max
		8:OCP-Min
Config	Config function	
	1:I Range	Set the current measurement range.
	3:On Phase	Set the starting phase angle of the waveform.
	4:Off Phase	Set the ending phase angle of the waveform.
System	System function	
	5:Relay Ctrl	Set the relay control.

- To test the DUT under Unbalance three-phase mode, you can connect the communication interface (GPIB/USB/RS232/LAN/CAN) of the host A to the PC. Please refer to [2.5 Connecting the Interface](#).

Set the three-phase voltage value and the angle difference of the three phases through PC. For specific setting instructions, please refer to "IT-M7700 Programming and Grammar Guide".

Revert to single mode

- Press the **[Link]** key on the front panel of master A to cancel the three-phase synchronization mode.
- Set each of the three instruments to single mode.

- a. Press the composite keys **[Shift]+[V-set]**(Config) to enter into the configuration menu interface.
- b. Rotate the knob to select **Parallel** and press **[Enter]** key to confirm.
- c. Rotate the knob to select **Single** and press **[Enter]** key to confirm.
3. Power off the three units and disconnect the power cord.
4. Remove the cables connection of the System Bus and AC output terminals between three units.
5. Power on the three units separately. After the instrument is restarted, the VFD shows that the instrument is working in single mode.

Note

In three-phase operation, the output waveform only supports Sine waveform.

5.3 Multi-Channel Function

IT-M7723 power supply support multi-channel function, the operation can be realized by the PC control software IT9000. By communicating one unit in the System Bus link with the PC, it is possible to independently control any other unit in the PC software.

For multi-channel operation controlled by the PC software, the user will need to install one communication card only into one of the multiples units, and other instruments are connected with the PC through a multi-channel connection with system bus. The cost of the communication cards is saved, and the connection interface on the PC side is also reduced. Up to 126 channels, each instrument in the control system can be controlled independently in software, and each channel can be operated completely independently.

When multiple power supplies are connected through the System Bus interface, each power supply must be set to a separate channel number ranging from 1 to 126. The power supply connected to the same system bus, the channel number can not be repeated, otherwise it will cause conflicts. All power interfaces will prompt "Chan Number Conflict". In this case, rotate the knob to change the channel number directly, press **[Enter]** to confirm.

The following three instruments are taken as an example to describe the connection and operation steps of multiple channels.

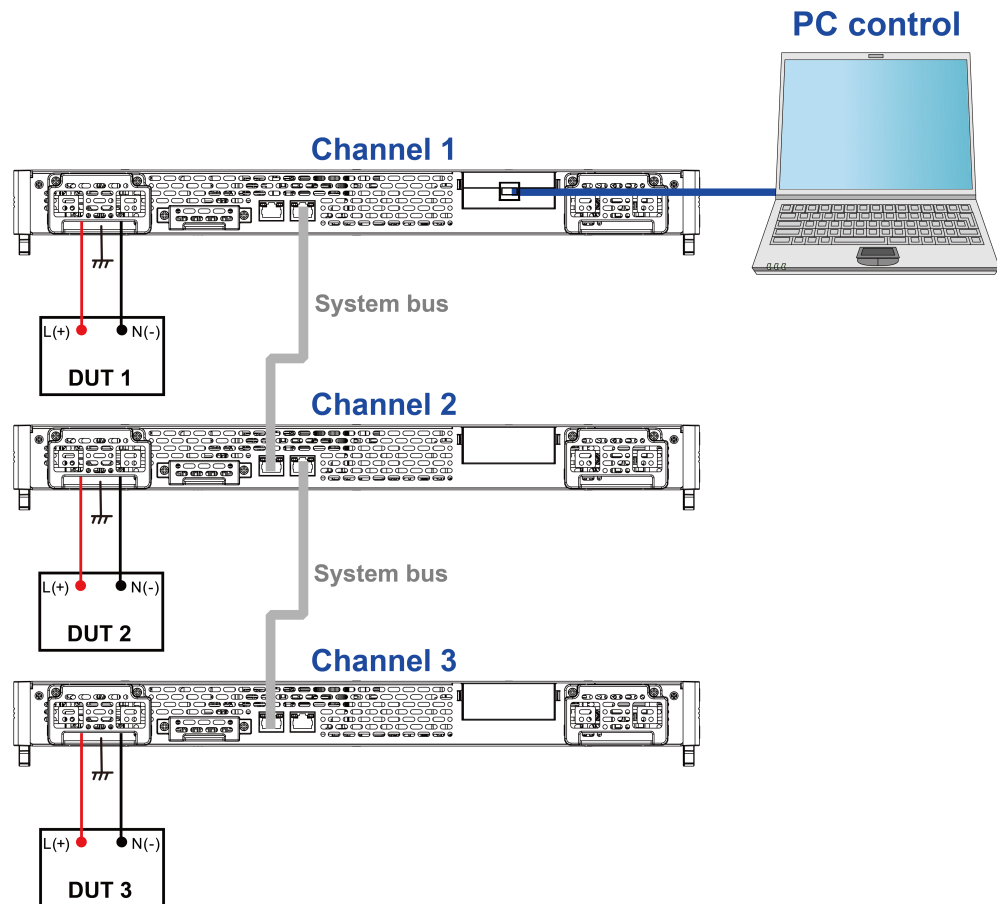

The procedures to set the multiple channels are as follows.

1. Set the channel number for each instrument.
 - a. Press the **[Shift]+[P-set]** (Config) composite keys to enter into the configuration menu interface.
 - b. Rotate the knob to select **Channel Number** and press **[Enter]** key to make the parameter in modification.
 - c. Rotate the knob to adjust the value and set the channel number, the setting range is between 0–126. Press **[Enter]** to confirm.
 - d. Repeat steps a through c to set the channel number for other instrument.
2. Connect the instruments according to the above diagram. Please disconnect the power before wiring.
 - a. Connect system bus interfaces.
 - b. Connect the DUTs. Refer to [2.4 Connecting the Device Under Test \(DUT\)](#) for more information about connection methods.
 - c. Connect the instrument to PC. refer to [2.5 Connecting the Interface](#).

3. Through the PC software, send SCPI commands to control the specified instrument or all instruments on the line. For details, see the content of the multi-channel command chapter of "IT-M7700 Programming Guide".

6 Routine Maintenance

This chapter describes general maintenance items and maintenance methods of the IT-M7700 series power source.

- ◆ Instrument Self-Test
- ◆ Cleaning and Maintenance
- ◆ Prompt Information Reference
- ◆ Contact of ITECH Engineers
- ◆ Return for Repair

6.1 Instrument Self-Test

Self-test checks that the minimum set of logic and power mesh systems are functioning properly. Self-test does not enable the output or place any voltages on the output. Self-test can be achieved in two ways:

- Re-start the instrument. Each time the instrument is powered on, the selftest is performed. This test assumes that the instrument is running.
- SCPI command: *TST?. If the return value is 0, the self-test passes; if it is 1, the self-test fails. If the self-test fails, please send command SYSTem:ER-Ror? to view the self-test error. Please refer to IT-M7700 Programming Guide for the list of error codes.

6.2 Cleaning and Maintenance

To ensure the safety function and performance of the instrument, please clean and maintain the instrument properly.

WARNING

- **To prevent electrical shock, disconnect the instrument from AC mains power and disconnect all test leads before cleaning.**
 - **Do not use detergent or solvents.**
 - **Do not disassemble the instrument and attempt to clean internally.**
-

Clean the outside and the front panel screen of the instrument using a soft, lint free, cloth slightly dampened with water. Use a brush to clean the dust on the vent and cooling fans.

6.3 Prompt Information Reference

The IT-M7700 series power supply has a detailed error and prompt information function, so as to help the user to easily carry out positioning and measurement during measurement and use.

This section describes all error information of the IT-M7700 series power supply as well as disposals. All prompt information is listed.

Error information list

Error information	Description and disposals
OVPrms Occurred!!	The voltage value read on the panel exceeds the OVPrms setting value. Check whether the OVPrms setting value is too low or the output voltage setting value is too high.
OVPpeak Occurred!!	The peak value of the output voltage readback exceeds the OVPpeak setting value. Check whether the OVPpeak setting value is too low or the output voltage peak value is too high.
UVPrms Occurred!!	The readback value when the output voltage is stable is lower than the UVPrms setting value. Check whether the UVPrms setting value is too high or whether there is sudden voltage drop due to abnormal loading.
OCPrms Occurred!!	The current value read on the panel exceeds the OCPrms setting value. Check whether the OCPrms setting value is too low or whether the load is too large.
OCPpeak Occurred!!	The peak value of the output current readback exceeds the OCPpeak setting value. Check whether the OCPpeak setting value is too low or the output current peak value is too high.
OPP Occurred!!	The total output power exceeds the OPP setting value. Check whether the OPP setting value is too low or whether the load is too large.
Over Temp Occurred!!	The system temperature is too high. Check whether the fan is stopped or whether the rotation speed is not increased along with the output load.
Fan Error Occurred!!	The fan rotation speed cannot be detected. Check whether the fan is stopped due to abnormality.
DD_OCP Occurred!!	The over-current protection of the hardware (DCtoDC power level) is triggered. Check whether the output has short circuit or abnormal loading.
DA_OCOVP Occurred!!	The hardware protection of the hardware (DCtoAC power level) is triggered. Check whether the output has short circuit or abnormal loading.
PFC fail Occurred!!	The communication cannot be established between the DSP control board and PFC power level.

Error information	Description and disposals
OPP Limit Occurred!!	The instantaneous output power exceeds the maximum load that the hardware can bear. Check whether the output has short circuit or abnormal loading.
DSP disconnected!!	The communication of the control board is abnormal. Check the communication cable between the UI display board and the control board (DSP).
Interface disconnected!!	The adapter card communication is abnormal or the communication card is not installed.
SCPI Error xxx	There is a SCPI command error. Refer to "SYS- Tem:ERRor?" in the <i>IT-M7700 Programming and Syntax Guide</i> for codes.
System Restart	PFC power level startup abnormal.

Prompt message list

Prompt message	Description
TEST MEMORY	The memory is initialized.
List Test x	The List x data is initialized.
Read LIST x Data	Read the xth LIST data.
AC Power Off	Switch off the power.
Invalid in Output Mode	This operation is unavailable under the Output mode.
Invalid in DC Mode	This operation is unavailable under the DC mode.
Over 100 Hz	The frequency setting is over 100 Hz and the MCL cannot be adjusted at this time.
Invalid in AC+DC = Off	When the AC+DC function is off, the AC or DC cannot be switched when the power output is On.
Invalid in Analog Ctrl	V-Set and I-Set are controlled by analog and cannot be controlled from the front panel of the power supply.

6.4 Contact of ITECH Engineers

This section describes operations to be carried out by the user in case of failure of the instrument.

Preparation before contact

When the instrument fails, you should make the following preparations before returning the instrument to ITECH for repair or contacting engineers.

- Check all the items listed in the [Self-inspection of equipment faults](#) and confirm whether there are still some problems.
- [Collect the SN number](#)

If there are still some problems, carefully read the Warranty and Limitation of Warranty in the preface of the manual. Confirm that your instrument complies with warranty service conditions. If after your warranty expires, ITECH offers repair services at competitive prices.

Self-inspection of equipment faults

When the instrument fails, make the following checks to ensure that the failure is in the instrument rather than any external connections. If the instrument failure can be eliminated via simple inspection, the maintenance cost and time can be saved.

- Check whether the AC power cord is securely connected to the instrument and to a powered outlet.
- Check whether the front-panel Power On switch has been pushed.
- Check whether self-inspection of the instrument is successful and whether the specifications and performance are within the indicator ranges.
- Check whether the instrument displays error information.
- Use other instruments instead of this instrument for confirmation.

Collect the SN number

ITECH will constantly improve the product performance, availability and reliability. The service personnel of ITECH will record changes of each instrument. All relevant information is marked uniquely according to the serial number of each instrument. The equipment returned for repair must adopt the SN number as the tracking ID.

When you contact the engineer, the effective SN number of the instrument will be the effective guarantee for effective service and complete information. You can obtain the SN number of the instrument by the following ways:

1. Press the composite keys **[Shift]+[DC]**(System) to enter into the system menu interface.
2. Rotate the knob to select **System Info** and press **[Enter]** key to confirm.
3. Rotate the knob to view the SN number.

Please record the SN number and provide SN information when doing maintenance service.

How to contact ITECH engineers

Access ITECH official website www.itechate.com or call the service number 4006-025-000 for technical support and services.

6.5 Return for Repair

If your instrument fails during the warranty period, ITECH will repair or replace it under the terms of your warranty. After your warranty expires, ITECH offers repair services at competitive prices. Also you can purchase an extended maintenance service contract that exceeds the standard warranty period.

Get Repair Service

To get the service for your instrument, choose the easiest way to contact the ITECH engineers. ITECH will arrange for repair or replacement of your instrument or provide warranty and repair cost information (if applicable).

Repackaging for Shipment

CAUTION

Never use styrene pellets in any shape as packaging materials. They do not adequately cushion the instrument or prevent it from shifting in the carton. Styrene pellets cause the instrument damage by generating static electricity and by lodging in the rear panel.

ITECH recommends that you retain the original shipping carton for return shipments and always insure shipments. To ship the unit to ITECH for service or repair:

1. Download the ITECH maintenance service application from our website, complete it and place it in the box with the instrument.
2. Place the unit in its original container with appropriate packaging material.

If the original shipping container is unavailable, use a container that will ensure at least 10 cm (4 in.) of compressible packaging material around the entire instrument. Use static-free packaging materials.

3. Secure the container with strong tape or metal bands.

7 Technical Specification

This chapter will introduce the rated voltage, current, power and many other main parameters of IT-M7700 series power source.

- ◆ IT-M7721
- ◆ IT-M7721L
- ◆ IT-M7722
- ◆ IT-M7722L
- ◆ IT-M7723
- ◆ IT-M7723E

7.1 IT-M7721

Parameter	IT-M7721
AC Input	
Voltage	100 ~ 240Vac
Phase	Single-phase
Frequency	47 ~ 63Hz
Max.current	4.3A
Power factor	0.99 (Typical)
AC Output	
Max. output power	300VA
Max. output voltage	300V
Output phase	Single-phase
Current range(rms)	3A
Current range(peak)	9A
Output frequency range	45 ~ 1000Hz
Phase angle degree range	0 ~ 359.9°
THD*1*3	≤0.3% at f=45 ~ 100Hz
	≤1% at f=101 ~ 800Hz
	≤ (0.15%f-0.2)% at f=801 ~ 1000Hz
Crest factor	3
Line Regulation *3	≤0.06%

Parameter		IT-M7721
Load Regulation *3		≤0.15%
Output voltage (VAC)	Resolution	0.1V
	Accuracy	±(0.2%+0.2% F.S.)
Frequency	Resolution	0.1Hz
	Accuracy	±0.1%
Phase angle degree range	Resolution	0.1°
	Accuracy	0.5°
DC offset value		20mVdc
Efficiency		75% (Typical)
DC Output		
Max. output power		300W
Max. output voltage		±400Vdc
Maximum output current (rms)		±3A
DC voltage	Accuracy	±(0.2%+0.2% F.S.)
Dynamic response time (Full load of 10~90%)		≤0.5ms
Meter		
AC Voltage	Range	0 ~ 300V
	Resolution	0.1V
	Accuracy	±(0.25%+0.25% F.S.)
AC current (rms, High range)	Range	0.1 ~ 3A
	Resolution	10mA
	Accuracy	±(0.5%+0.5% F.S.)
AC current (rms, low range at 100HZ)	Range	0.1 ~ 1250 mA
	Resolution	0.1mA
	Accuracy	±(0.25%+0.25% F.S.)
AC current (peak)	Range	0 ~ 4.25A
	Resolution	10mA
	Accuracy	±(0.4%+0.8% F.S.)
DC voltage	Accuracy	±(0.25%+0.25% F.S.)
DC current (High range)	Accuracy	±(0.25%+0.355% F.S.)
DC current (Low range)	Accuracy	±(0.25%+0.355% F.S.)

Parameter		IT-M7721
Frequency	Range	45 ~ 1000Hz
	Resolution *5	0.1Hz
	Accuracy *2	±0.1%
Power *4 (S)	Resolution	100mVA
	Accuracy	±(0.5%+0.5% F.S.)
Other		
Protection		OTP, OCP, OVP, OPP
Dimension (WxHxD)	Without foot post, protective cover	215 × 44.45 × 450 mm
	With foot post, protective cover	234 × 57.02 × 500 mm
Weight		5 KG

*1: Min voltage for THD test is 100Vac.

*2: Min voltage for frequency display accuracy is 100Vac.

*3: Tested with pure resistive load.

*4: This specification is applicable below ≤800Hz.

*5: The applicable range of frequency resolution is 45~99.9Hz.

7.2 IT-M7721L

Parameter	IT-M7721L
AC Input	
Voltage	100 ~ 240Vac
Phase	Single-phase
Frequency	47 ~ 63Hz
Max.current	4.3A
Power factor	0.99 (Typical)
AC Output	
Max. output power	300VA
Max. output voltage	300Vac
Output phase	Single-phase
Current range(rms)	3A

Parameter		IT-M7721L
Current range(peak)		9A
Output frequency range		45 ~ 100Hz
Phase angle degree range		0 ~ 359.9°
THD*1*3		≤0.3% at 45 ~ 100Hz
Crest factor		3
Line Regulation *3		≤0.06%
Load Regulation *3		≤0.15%
Output voltage (VAC)	Resolution	0.1V
	Accuracy	±(0.2%+0.2% F.S.)
Frequency	Resolution	0.1Hz
	Accuracy	±0.1%
Phase angle degree range	Resolution	0.1°
	Accuracy	0.5°
DC offset value		20mVdc
Efficiency		75% (Typical)
DC Output		
Max. output power		300W
Max. output voltage		±400Vdc
Maximum output current (rms)		±3A
DC voltage	Accuracy	±(0.2%+0.2% F.S.)
Dynamic response time (Full load of 10~90%)		≤0.5ms
Meter		
AC Voltage	Range	0-300V
	Resolution	0.1V
	Accuracy	±(0.25%+0.25% F.S.)
AC current (rms)	Range	0.1 ~ 3A
	Resolution	10mA
	Accuracy	±(0.5%+0.5% F.S.)
AC current (peak)	Range	0 ~ 4.25A
	Resolution	10mA
	Accuracy	±(0.4%+0.8% F.S.)
DC voltage	Accuracy	±(0.25%+0.25% F.S.)

Parameter		IT-M7721L
DC current	Accuracy	$\pm(0.25\%+0.355\% \text{ F.S.})$
Frequency	Range	45Hz ~ 100Hz
	Resolution *4	0.1Hz
	Accuracy *2	$\pm 0.1\%$
Power (S)	Resolution	100mVA
	Accuracy	$\pm(0.5\%+0.5\% \text{ F.S.})$
Other		
Protection		OTP, OCP, OVP, OPP
Dimension (WxHxD)	Without foot post, protective cover	215 × 44.45 × 450 mm
	With foot post, protective cover	234 × 57.02 × 500 mm
Weight		5 KG

*1: Min voltage for THD test is 100Vac.

*2: Min voltage for frequency display accuracy is 100Vac.

*3: Tested with pure resistive load.

*4: The applicable range of frequency resolution is 45~99.9Hz.

7.3 IT-M7722

Parameter	IT-M7722
AC Input	
Voltage	100 ~ 240Vac
Phase	Single-phase
Frequency	47 ~ 63Hz
Max.current	8.5A
Power factor	0.99 (Typical)
AC Output	
Max. output power	600VA
Max. output voltage	300V
Output phase	Single-phase
Current range(rms)	6A

Parameter		IT-M7722
Current range(peak)		18A
Output frequency range		45 ~ 1000Hz
Phase angle degree range		0 ~ 359.9°
THD*1*3		≤0.3% at 45 ~ 100Hz
		≤1% at 101 ~ 800Hz
		≤ (0.15%f-0.2)% at 801 ~ 1000Hz
Crest factor		3
Line Regulation *3		≤0.06%
Load Regulation *3		≤0.15%
Output voltage (VAC)	Resolution	0.1V
	Accuracy	±(0.2%+0.2% F.S.)
Frequency	Resolution	0.1Hz
	Accuracy	±0.1%
Phase angle degree range	Resolution	0.1°
	Accuracy	0.5°
DC offset value		20mVdc
Efficiency		80% (Typical)
DC Output		
Max. output power		600W
Max. output voltage		±400Vdc
Maximum output current (rms)		±6A
DC voltage	Accuracy	±(0.2%+0.2% F.S.)
Dynamic response time (Full load of 10~90%)		≤0.5ms
Meter		
AC Voltage	Range	0 ~ 300V
	Resolution	0.1V
	Accuracy	±(0.25%+0.25% F.S.)
AC current (rms, High range)	Range	0.1 ~ 6A
	Resolution	10mA
	Accuracy	±(0.25%+0.25% F.S.)
AC current (rms, low range at 100HZ)	Range	0.1 ~ 1250 mA
	Resolution	0.1mA

Parameter		IT-M7722
	Accuracy	$\pm(0.25\%+0.25\% \text{ F.S.})$
AC current (peak)	Range	0-8.5A
	Resolution	10mA
	Accuracy	$\pm(0.4\%+0.8\% \text{ F.S.})$
DC voltage	Accuracy	$\pm(0.25\%+0.25\% \text{ F.S.})$
DC current (High range)	Accuracy	$\pm(0.25\%+0.355\% \text{ F.S.})$
DC current (Low range)	Accuracy	$\pm(0.25\%+0.355\% \text{ F.S.})$
Frequency	Range	45 ~ 1000Hz
	Resolution *5	0.1Hz
	Accuracy *2	$\pm 0.1\%$
Power *4	Resolution	100mVA
	Accuracy	$\pm(0.5\%+0.5\% \text{ F.S.})$
Other		
Protection		OTP, OCP, OVP, OPP
Dimension (WxHxD)	Without foot post, protective cover	215 × 44.45 × 450 mm
	With foot post, protective cover	234 × 57.02 × 500 mm
Weight		5 KG

*1: Min voltage for THD test is 100Vac.

*2: Min voltage for frequency display accuracy is 100Vac.

*3: Tested with pure resistive load.

*4: This specification is applicable below $\leq 800\text{Hz}$.

*5: The applicable range of frequency resolution is 45~99.9Hz.

7.4 IT-M7722L

Parameter	IT-M7722L
AC Input	
Voltage	100 ~ 240Vac

Parameter		IT-M7722L
Phase		Single-phase
Frequency		47 ~ 63Hz
Max.current		8.5A
Power factor		0.99 (Typical)
AC Output		
Max. output power		600VA
Max. output voltage		300Vac
Output phase		Single-phase
Current range(rms)		6A
Current range(peak)		18A
Output frequency range		45 ~ 100Hz
Phase angle degree range		0 ~ 359.9°
THD*1*3		≤0.3% at 45 ~ 100Hz
Crest factor		3
Line Regulation *3		≤0.06%
Load Regulation *3		≤0.15%
Output voltage (VAC)	Resolution	0.1V
	Accuracy	±(0.2%+0.2% F.S.)
Frequency	Resolution	0.1Hz
	Accuracy	±0.1%
Phase angle degree range	Resolution	0.1°
	Accuracy	0.5°
DC offset value		20mVdc
Efficiency		80% (Typical)
DC Output		
Max. output power		600W
Max. output voltage		±400Vdc
Maximum output current (rms)		±6A
DC voltage	Accuracy	±(0.2%+0.2% F.S.)
Dynamic response time (Full load of 10~90%)		≤0.5ms
Meter		
AC Voltage	Range	0 ~ 300V

Parameter		IT-M7722L
	Resolution	0.1V
	Accuracy	$\pm(0.25\%+0.25\% \text{ F.S.})$
AC current (rms)	Range	0.1 ~ 6A
	Resolution	10mA
	Accuracy	$\pm(0.25\%+0.25\% \text{ F.S.})$
AC current (peak)	Range	0 ~ 8.5A
	Resolution	10mA
	Accuracy	$\pm(0.4\%+0.8\% \text{ F.S.})$
DC voltage	Accuracy	$\pm(0.25\%+0.25\% \text{ F.S.})$
DC current	Accuracy	$\pm(0.25\%+0.355\% \text{ F.S.})$
Frequency	Range	45 ~ 100Hz
	Resolution *4	0.1Hz
	Accuracy *2	$\pm 0.1\%$
Power (S)	Resolution	100mVA
	Accuracy	$\pm(0.5\%+0.5\% \text{ F.S.})$
Other		
Protection		OTP, OCP, OVP, OPP
Dimension (WxHxD)	Without foot post, protective cover	215 × 44.45 × 450 mm
	With foot post, protective cover	234 × 57.02 × 500 mm
Weight		5 KG

*1: Min voltage for THD test is 100Vac.

*2: Min voltage for frequency display accuracy is 100Vac.

*3: Tested with pure resistive load.

*4: The applicable range of frequency resolution is 45~99.9Hz.

7.5 IT-M7723

Parameter	IT-M7723
AC Input	
Voltage	100–240Vac

Parameter		IT-M7723
Phase		Single-phase
Frequency		47-63Hz
Max.current		18A
Power factor		0.99 (Typical)
AC Output		
Max. output power		1200VA
Max. output voltage		600Vac
Output phase		Single-phase
Current range(rms)		12A
Current range(peak)		36A
Output frequency range		45 - 1000Hz
Phase angle degree range		0 – 359.9°
THD*1*3*6		≤0.5% at f=45~100Hz
		≤1.5% at f=101~1000Hz
Crest factor		3
Line Regulation *3		≤0.06%
Load Regulation *3		≤0.15%
Output voltage *4 (VAC)	Resolution	0.1V
	Accuracy *6	±(0.2%+ 0.2% F.S.)
Frequency	Resolution	0.1Hz
	Accuracy	±0.1%
Phase angle degree range	Resolution	0.1°
	Accuracy	0.5°
DC offset value		50mVdc
Efficiency		78% (Typical)
DC Output		
Max. output power		1200W
Max. output voltage		±800Vdc
Maximum output current (rms)		±12A
DC voltage *4	Accuracy	±(0.2% + 0.2% F.S.)
Dynamic response time *5		≤0.5ms
Meter		

Parameter		IT-M7723
AC Voltage *4 (VAC)	Range	0-600V
	Resolution	0.1V
	Accuracy *6	$\pm(0.25\% + 0.25\% \text{ F.S.})$
AC current (rms) *4 (IAC)	Range	0.1 -12A
	Resolution	10mA
	Accuracy *6	$\pm(0.25\% + 0.25\% \text{ F.S.})$
AC current (peak) *4(IP)	Range	0-17A
	Resolution	10mA
	Accuracy *6	$\pm(0.4\% + 0.8\% \text{ F.S.})$
DC voltage *4 (VDC)	Accuracy	$\pm(0.25\% + 0.25\% \text{ F.S.})$
DC current *4(IDC)	Accuracy	$\pm(0.25\% + 0.355\% \text{ F.S.})$
Frequency	Range	45-1000Hz
	Resolution *7	0.1Hz
	Accuracy *2	$\pm 0.1\%$
Power *4	Resolution	100mVA
	Accuracy	$\pm(0.5\% + 0.5\% \text{ F.S.})$
Other		
Protection		OTP, OCP, OVP, OPP
Interface		GPIB、USBTMC、LAN、RS232
Dimension (WxHxD)	Without foot post, protective cover	680 × 436 × 44 mm
	With foot post, pro- tective cover	730 × 457 × 57 mm
Weight		12KG

*1: Min voltage for THD test is 100Vac.

*2: Min voltage for frequency display accuracy is 100Vac.

*3: Tested with pure resistive load.

*4 : F.S. value is full range.

*5 : From 10% to 90% full load.

*6: For specifications above 800Hz, multiply by 1.2.

*7: The applicable range of frequency resolution is 45~99.9Hz.

7.6 IT-M7723E

Parameter		IT-M7723E
AC Input		
Voltage		100 ~ 240Vac
Phase		Single-phase
Frequency		47 ~ 63Hz
Max.current		20A
Power factor		0.99 (Typical)
AC Output		
Max. output power		1500VA
Max. output voltage		300V
Output phase		Single-phase
Current range(rms)		15A
Current range(peak)		45A
Output frequency range		45 ~ 1000Hz
Phase angle degree range		0 ~ 359.9°
THD*1*3		≤0.3% at 45 ~ 100Hz
		≤1% at 101 ~ 800Hz
		≤ (0.15%f-0.2)% at 801 ~ 1000Hz
Crest factor		3
Line Regulation *3		≤0.06%
Load Regulation *3		≤0.15%
Output voltage (VAC)	Resolution	0.1V
	Accuracy	±(0.2%+0.2% F.S.)
Frequency	Resolution	0.1Hz
	Accuracy	±0.1%
Phase angle degree range	Resolution	0.1°
	Accuracy	0.5°
DC offset value		20mVdc
Efficiency		83% (Typical)
DC Output		
Max. output power		1500W

Parameter		IT-M7723E
Max. output voltage		±400Vdc
Maximum output current (rms)		±15A
DC voltage	Accuracy	±(0.2%+0.2% F.S.)
Transient Response Time		≤0.5ms
(Full load of 10~90%)		
Meter		
AC Voltage	Range	0 ~ 300V
	Resolution	0.1V
	Accuracy	±(0.25%+0.25% F.S.)
AC current (rms, High range)	Range	0.1 ~ 15A
	Resolution	10mA
	Accuracy	±(0.25%+0.25% F.S.)
AC current (rms, low range at 100HZ)	Range	0.1 ~ 1250 mA
	Resolution	0.1mA
	Accuracy	±(0.25%+0.25% F.S.)
AC current (peak)	Range	0 ~ 50A
	Resolution	10mA
	Accuracy	±(0.4%+0.8% F.S.)
DC voltage	Accuracy	±(0.25%+0.25% F.S.)
DC current (High range)	Accuracy	±(0.25%+0.355% F.S.)
DC current (Low range)	Accuracy	±(0.25%+0.355% F.S.)
Frequency	Range	45 ~ 1000Hz
	Resolution *5	0.1Hz
	Accuracy *2	±0.1%
Power *4	Resolution	100mVA
	Accuracy	±(0.5%+0.5% F.S.)
Other		
Protection		OTP, OCP, OVP, OPP

Parameter		IT-M7723E
Dimension (WxHxD)	Without foot post, protective cover	215 × 88.2 × 450 mm
	With foot post, protective cover	235.4 × 101.7 × 505.5 mm
Weight		9 KG

***1:** Min voltage for THD test is 100Vac.

***2:** Min voltage for frequency display accuracy is 100Vac.

***3:** Tested with pure resistive load.

***4:** This specification is applicable below $\leq 800\text{Hz}$.

***5:** The applicable range of frequency resolution is 45~99.9Hz.

A Appendix

- ◆ Specifications of Red and Black Test Cables
- ◆ Built-in Waveforms

A.1 Specifications of Red and Black Test Cables

ITECH provides you with optional red and black test cables, which are sold individually and you can select for test. For specifications of ITECH test cables and maximum current values, refer to the table below.

Model	Specification	Length	Description
IT-E30110-AB	10A	1m	A pair of red and black test cables with an alligator clip at one end and a banana plug at the other end
IT-E30110-BB	10A	1m	A pair of red and black test cables with banana plugs at both ends
IT-E30110-BY	10A	1m	A pair of red and black test cables with a banana plug at one end and a Y-terminal at the other end
IT-E30312-YY	30A	1.2m	A pair of red and black test cables with Y-terminals at both ends
IT-E30320-YY	30A	2m	A pair of red and black test cables with Y-terminals at both ends
IT-E30615-OO	60A	1.5m	A pair of red and black test cables with round terminals at both ends
IT-E31220-OO	120A	2m	A pair of red and black test cables with round terminals at both ends

Model	Specifica- tion	Length	Description
IT-E32410-OO	240A	1m	A pair of red and black test ca- bles with round terminals at both ends
IT-E32420-OO	240A	2m	A pair of red and black test ca- bles with round terminals at both ends
IT-E33620-OO	360A	2m	A pair of red and black test ca- bles with round terminals at both ends

For maximum current of AWG copper wire, refer to table below.

AWG	8	10	12	14	16	18	20	22	24	26	28
The Maxi- mum Current Value (A)	60	40	30	20	13	10	7	5	3.5	2.5	1.7



Note

- AWG (American Wire Gage), it means X wire (marked on the wire). The table above lists current capacity of single wire at working temperature of 30°C. For reference only.
- Along with temperature, you must also consider voltage drop when selecting wire sizes.

Although the instrument will compensate for the voltage in the wires, it is recommended to minimize the voltage drop as much as possible to prevent excessive power consumption from the instrument and poor dynamic response to load changes. Larger diameter wire sizes will help minimize wire voltage drops. Twisting or bundling wires will help reduce transient voltage drops.

A.2 Built -in Waveforms

The ITM7700 series power supply is built in with 30 waveforms up to 40 times of harmonic distortion. The table below lists each time of harmonic component of each harmonic wave. In the table below, N means the number of harmonic waves, and % means the percentage of this time of harmonic wave in the base

waveform (1 time) components. The component of other times of harmonic waves not listed is 0.

Waveforms	Component
-----------	-----------

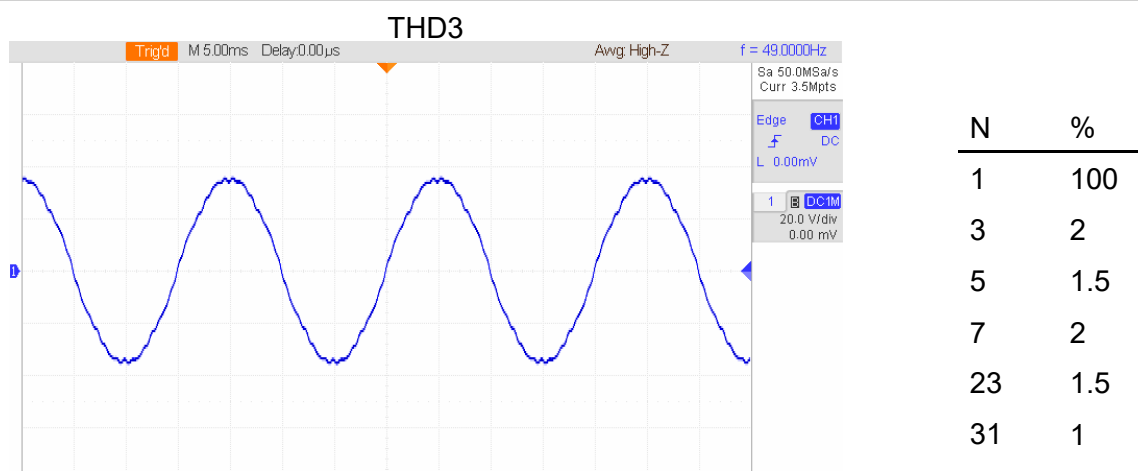
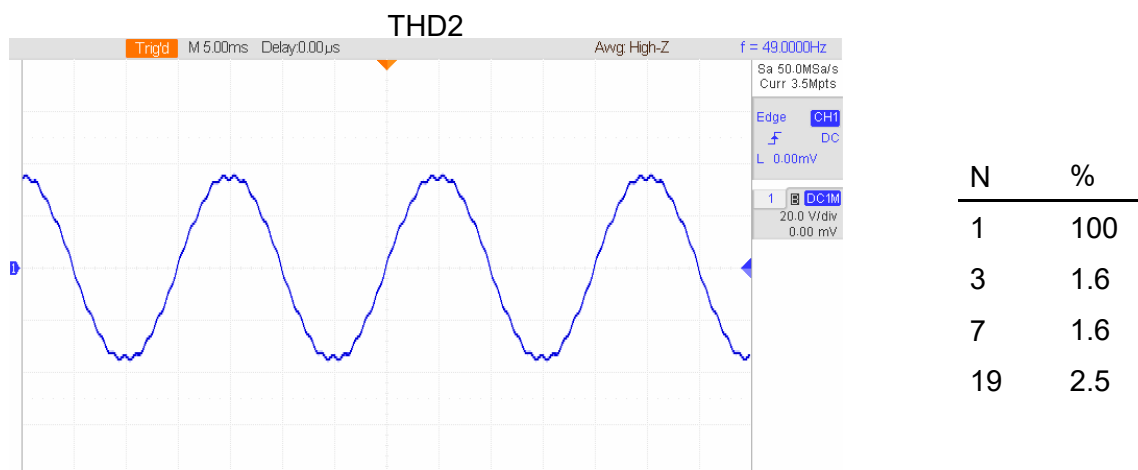

Waveforms	Component
-----------	-----------

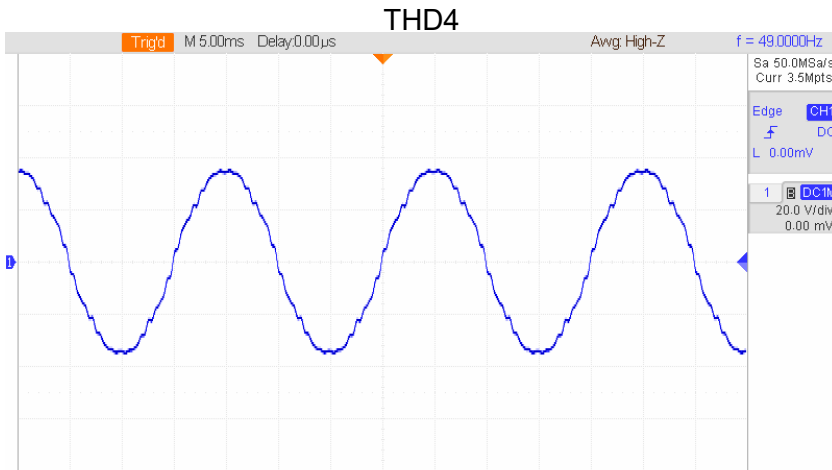

N	%
1	100
3	2.5
5	2
7	2.5
23	2
25	1.2
31	1.5
33	1.2

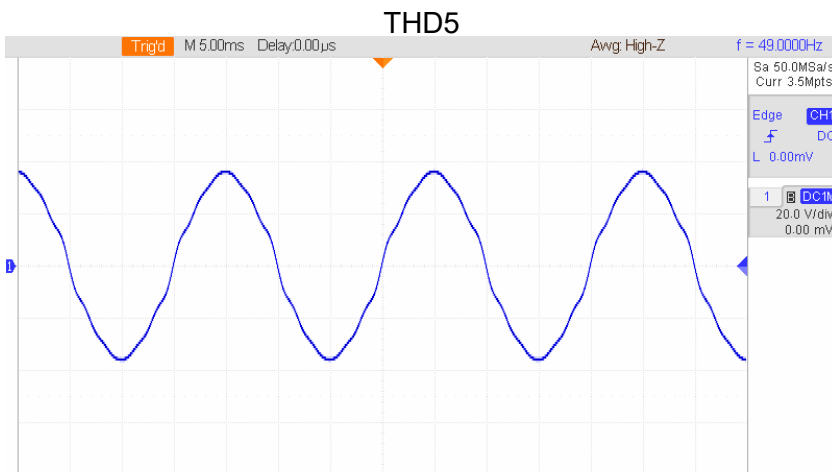

N	%
1	100
3	1.2
5	3
7	1.5
9	2.5
11	1.5

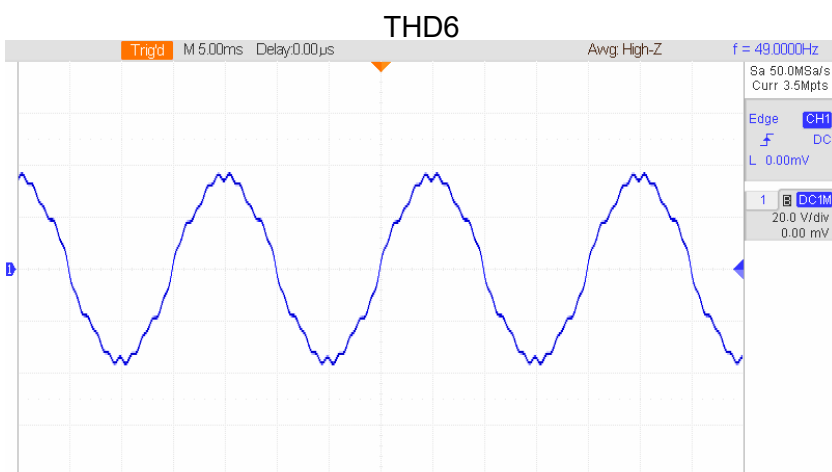

N	%
1	100
3	1.65
5	4.5
7	3.5
15	1.1
19	3

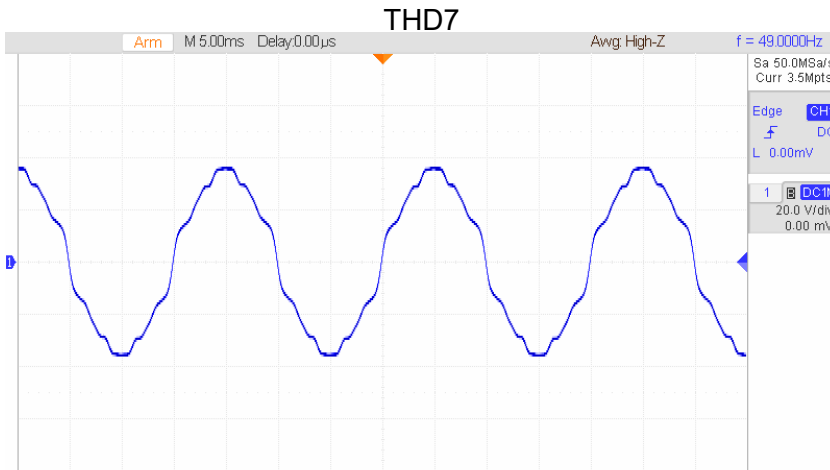
Waveforms
Component

N	%
1	100
3	2.5
5	5.5
7	3
9	4.5
11	3
15	1.5
21	1

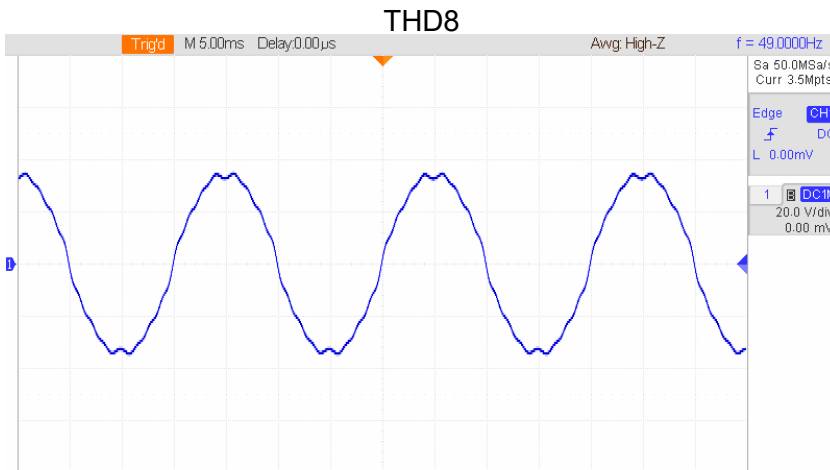

N	%
1	100
3	5
5	1.6
7	2.8
11	1.5
15	2
17	1.2

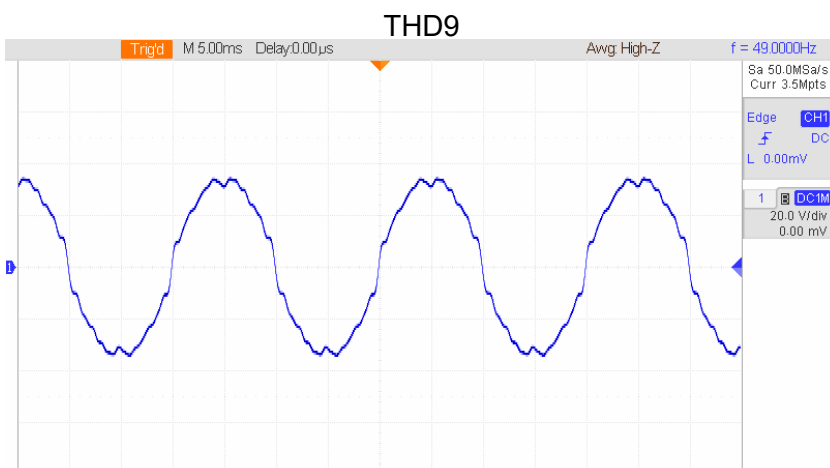

N	%	N	%
1	100	15	3
3	7.35	17	1.65
5	2.5	19	1.1
7	4.05	21	1.05
11	2.2	23	1.2
13	1.05	26	1.05

Waveforms	Component
-----------	-----------

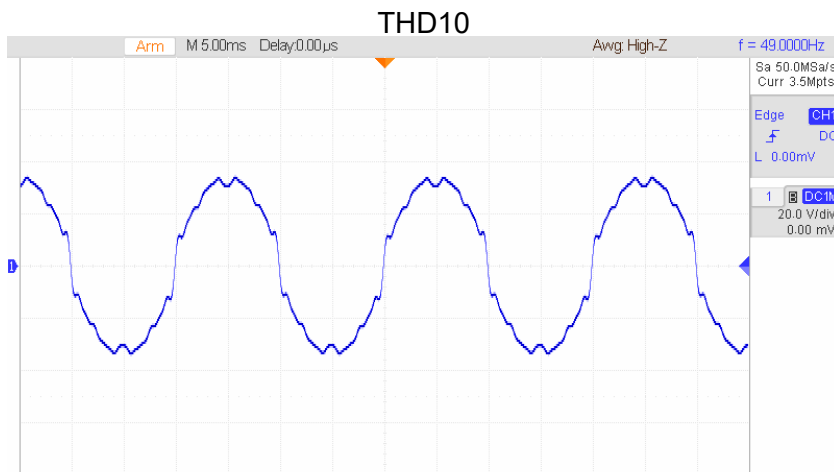

	N	%		N	%
	1	100		15	4
	3	9.9		17	2.3
	5	3.3		19	1.5
	7	5.5		21	1.5
	9	1.25		23	1.6
	11	2.8		25	1.5
	13	1.5			

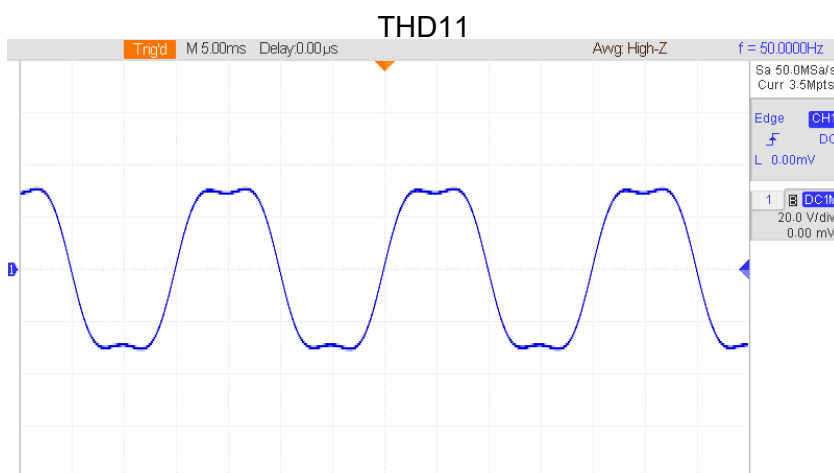

	N	%
	1	100
	3	17.8

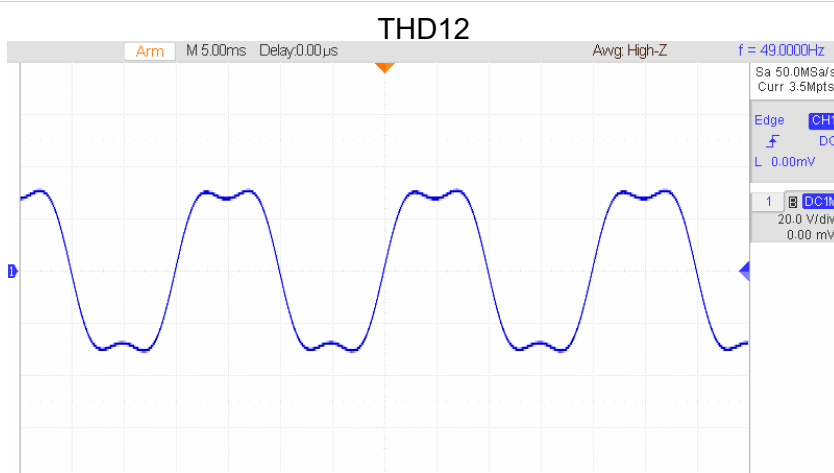

	N	%
	1	100
	3	21.3

Waveforms	Component
-----------	-----------

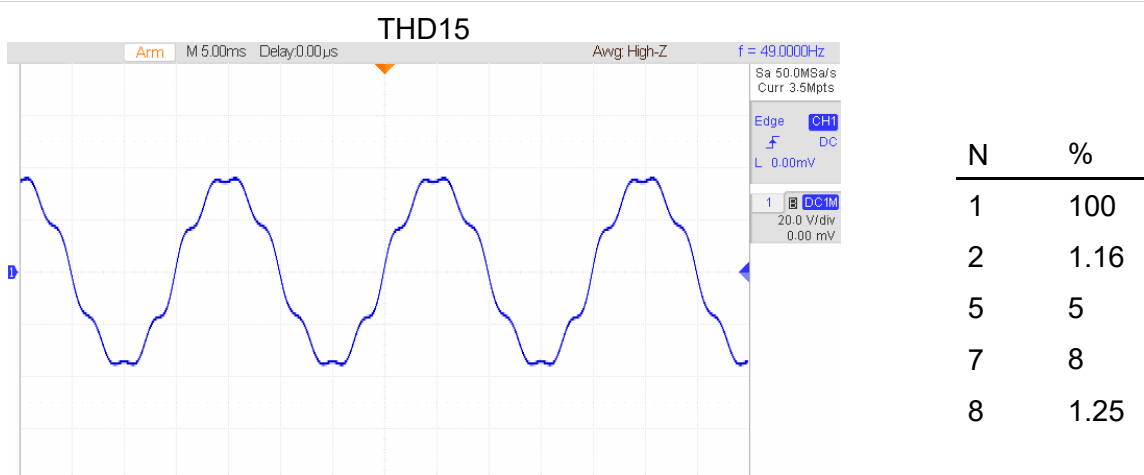
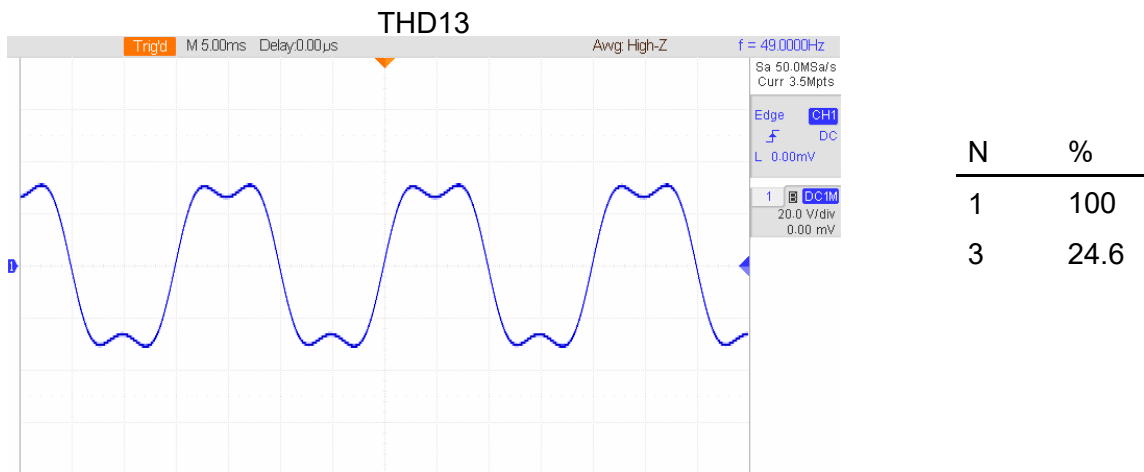

Waveforms	Component
-----------	-----------

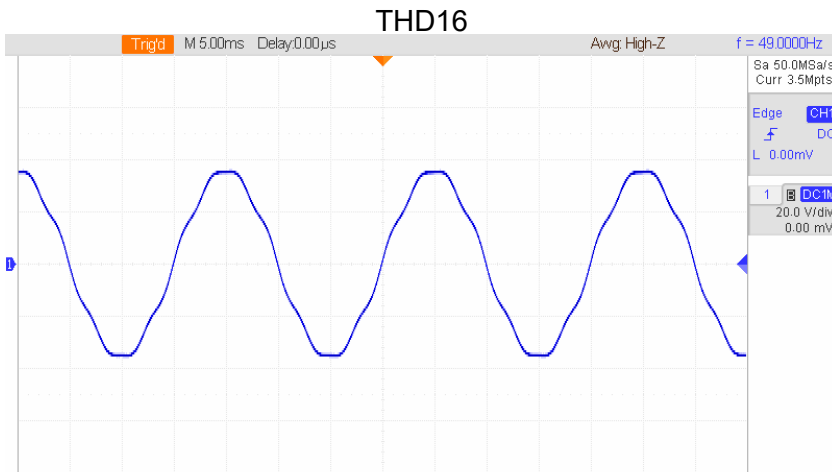

N	%
1	100
5	2.46
7	3.98

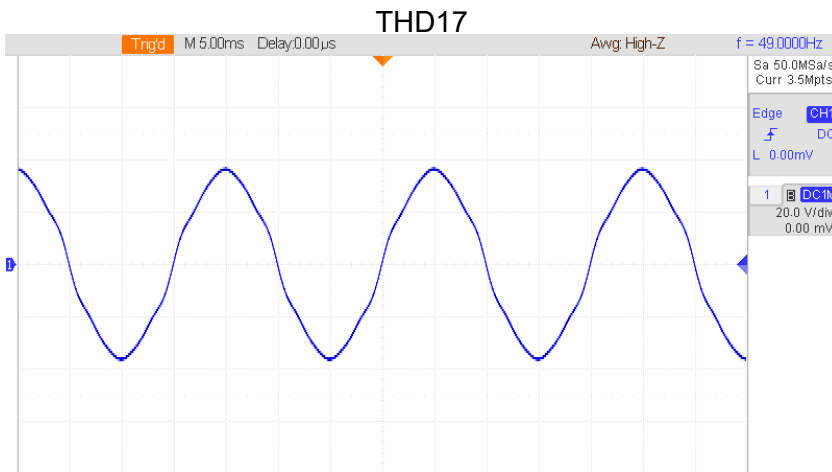

N	%
1	100
3	1.15
5	4.1
7	2
9	1.3



N	%
1	100
3	7.18
5	3.45
9	0.8

Waveforms	Component
-----------	-----------

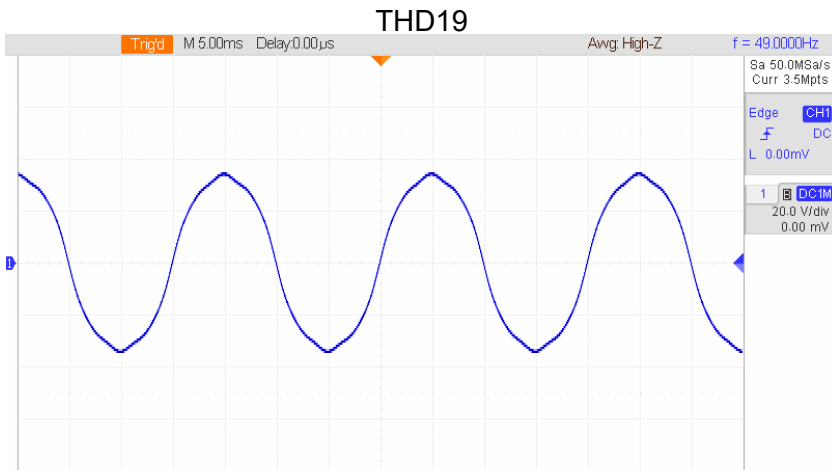

N	%
1	100
3	8.13
5	3.46
9	1



N	%
1	100
3	9.4
5	3.45
9	1.15

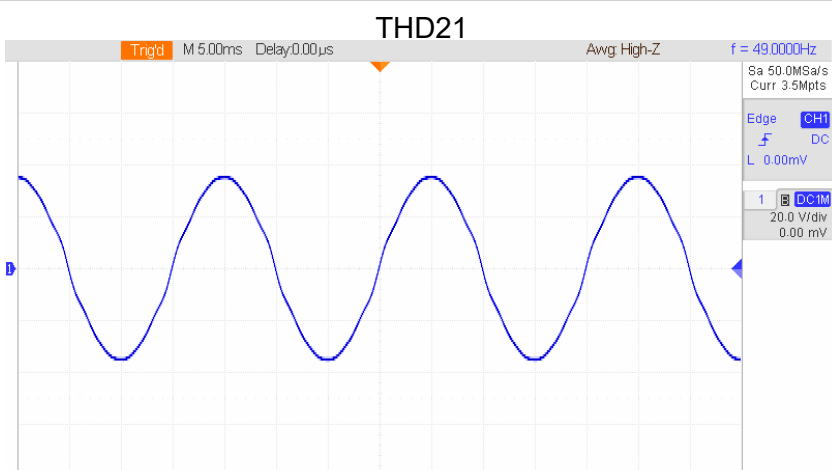

N	%
1	100
3	2
5	1.85
7	1.65
9	1.25
11	0.9

Waveforms	Component
-----------	-----------

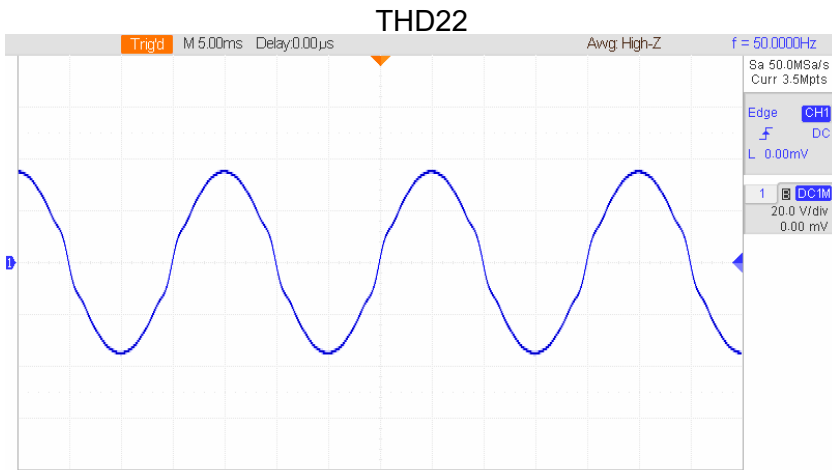

N	%
1	100
3	3
5	2.75
7	2.45
9	2
11	1.45
13	0.85

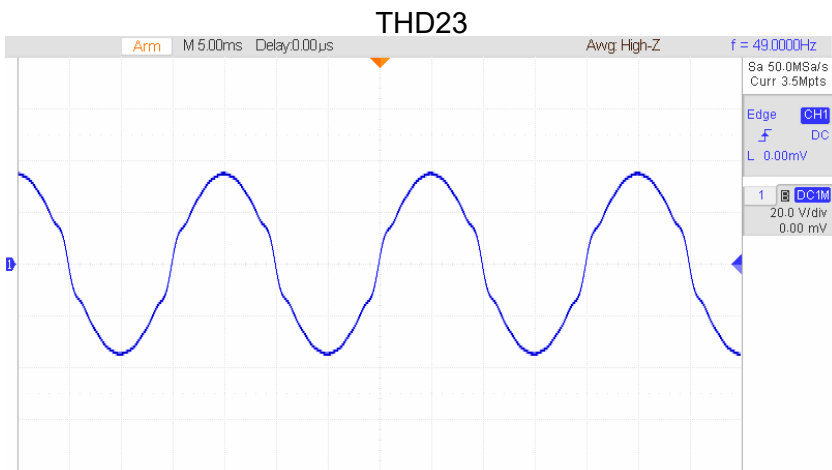

N	%
1	100
3	4.15
5	3.85
7	3.25
9	2.62
11	2
13	1.24

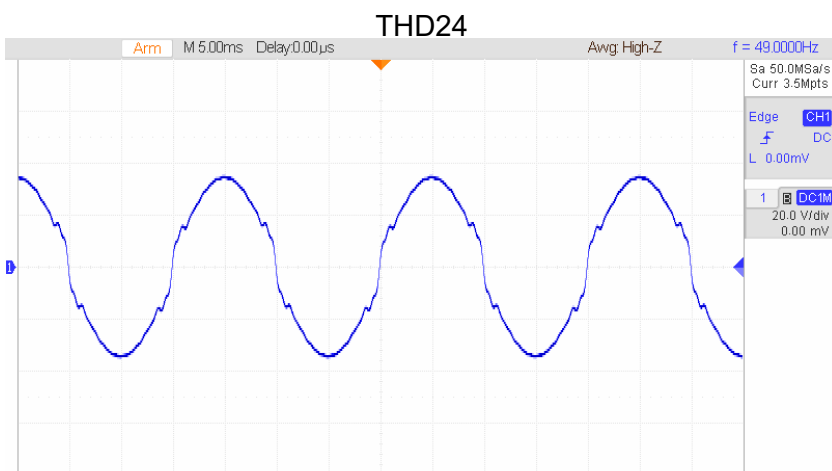

N	%	N	%
1	100	15	0.8
3	5.65	21	1.05
5	5.14	23	1.26
7	4.43	25	1.33
9	3.55	27	1.21
11	2.64	29	0.94
13	1.67		

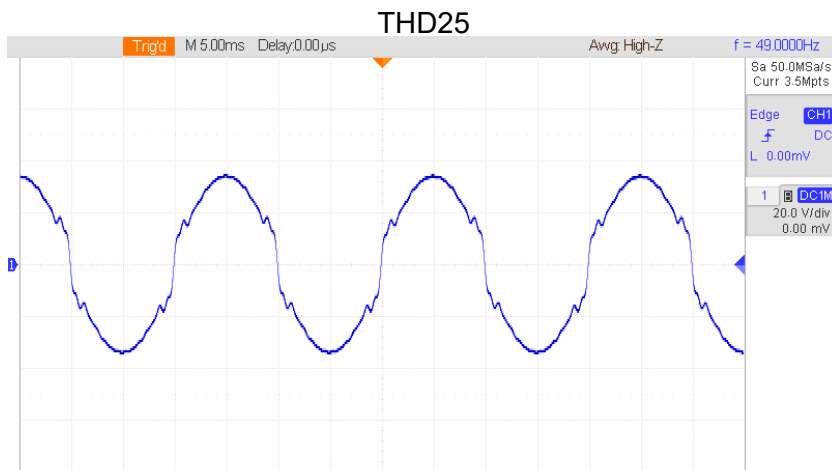
Waveforms
Component

N	%	N	%
1	100	15	1.03
3	7.29	21	1.33
5	6.32	23	1.64
7	5.72	25	1.68
9	4.6	27	1.55
11	3.43	29	1.25
13	2.18		

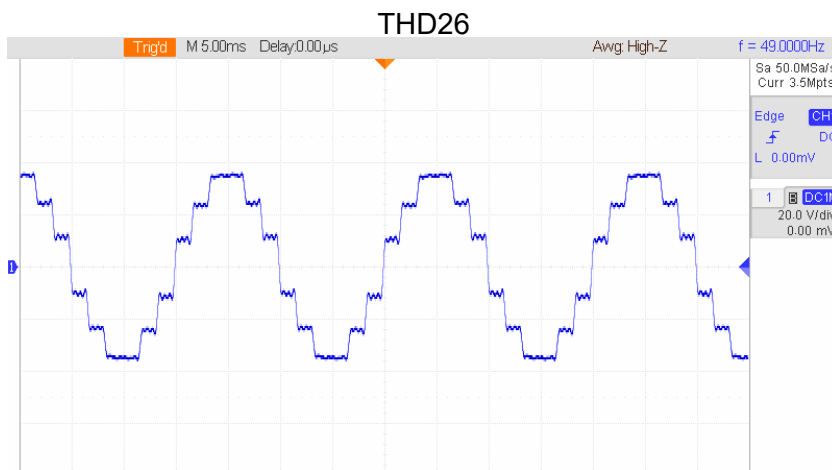

N	%	N	%
1	100	19	1.03
5	3.55	23	4.13
7	2.67	25	4.15
11	8.88	35	2.62
13	7.85	37	2.85

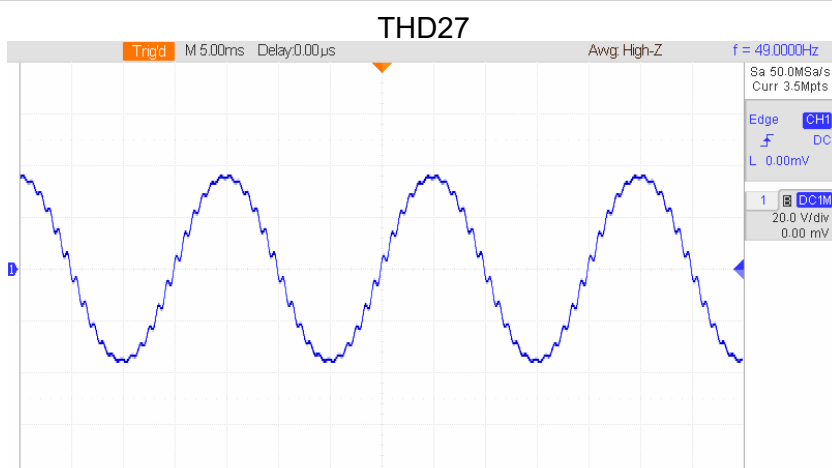

N	%
1	100
21	1.39
23	5.4
25	2.28

Waveforms	Component
-----------	-----------

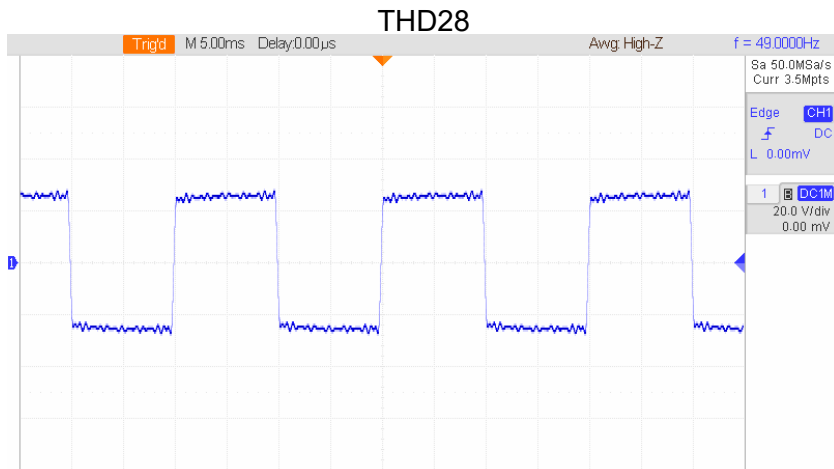

N	%	N	%
1	100	21	4.5
3	33.35	23	4
5	20.05	25	3.26
7	13.85	27	2.96
9	10.82	29	0.26
11	8.52	31	2
13	7.23	33	2
15	6.5	35	2
17	5	37	2
19	5	39	2

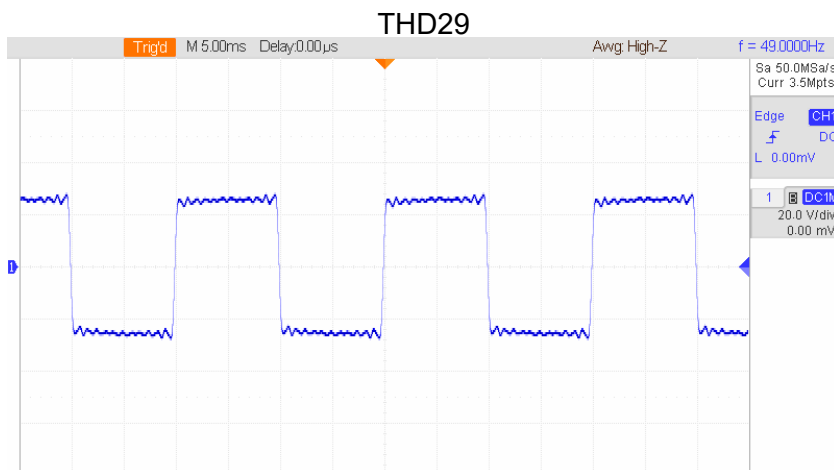

N	%	N	%
1	100	21	4.49
3	33.35	23	4
5	20.05	25	1
7	13.85	27	1
9	10.82	29	1
11	8.52	31	1
13	7.23	33	1
15	6.5	35	1
17	5	37	1
19	5	39	1

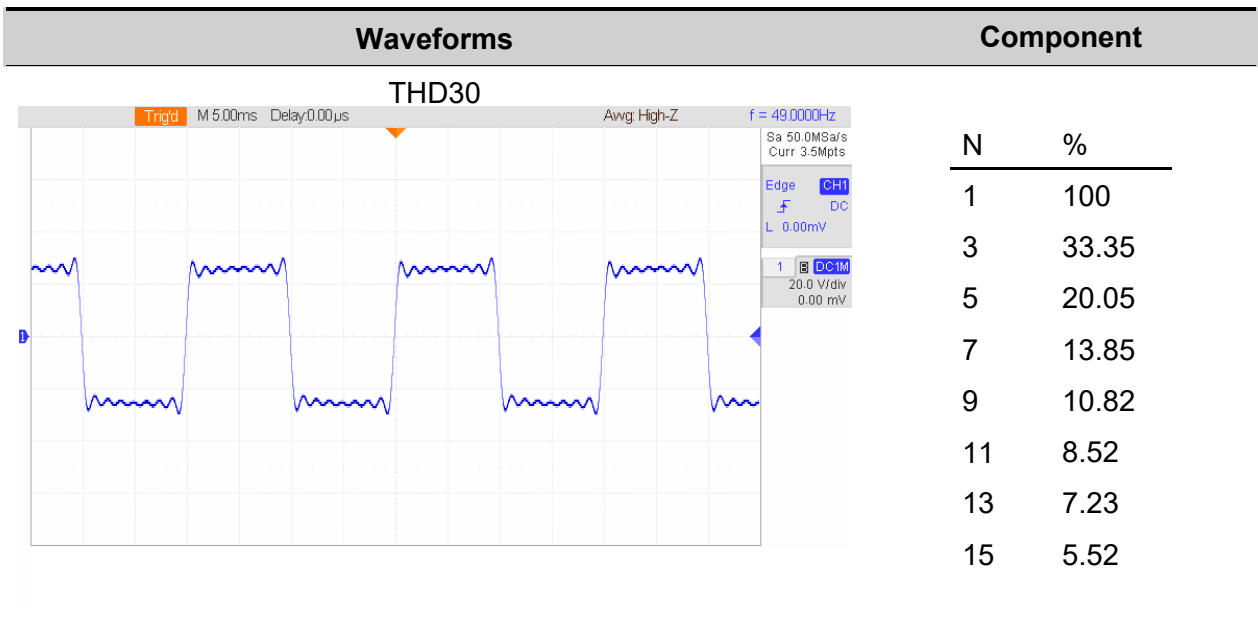

Connect with us

Thank you for purchasing ITECH products. Any questions, pls. feel free to let us know.

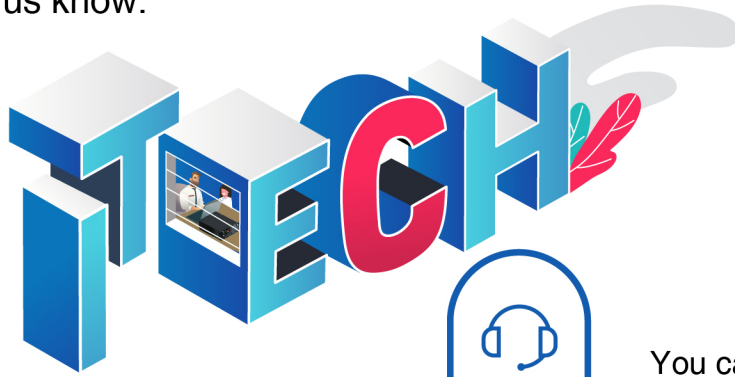

You can chat with us on ITECH website



For more information, pls. visit www.itechate.com



Click and follow ITECH Electronics

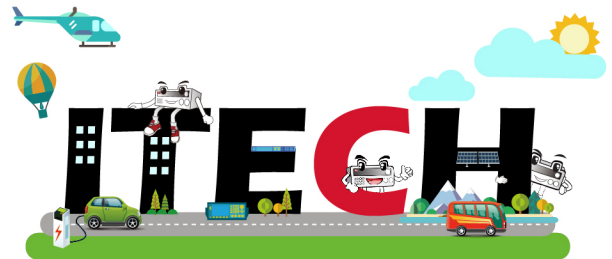

[Facebook](#)



[LinkedIn](#)



[YouTube](#)