

DELTA ELECTRONICS (THAILAND) PCL.
111 MOO 9, WELLGROW INDUSTRIAL ESTATE,
BANGNA-TRAD ROAD, BANGWUA, BANGPAKONG,
CHACHEONGSAO 24180 THAILAND.

TEL : +66-(0)38-522360-8
FAX : +66-(0)38-522477

STATEMENT OF DEVIATION

NONE

DESCRIPTION :

DELTA ELECTRONICS (THAILAND) PCL.
 111 MOO 9, WELLGROW INDUSTRIAL ESTATE,
 BANGNA-TRAD ROAD, BANGWUA, BANGPAKONG,
 CHACHEONGSAO 24180 THAILAND.

TEL : +66-(0)38-522360-8
 FAX : +66-(0)38-522477

SPECIFICATION FOR APPROVAL

Customer:	DPC	
Description:	DC BLOWER	
Customer P/N:		REV:
Delta Model NO.:	BFB1012EF-0018H	Delta safety model NO.: N/A
Sample Rev:	01	Issue NO:
Sample Issue Date:	MAY.22.2019	Quantity:

1. SCOPE:

THIS SPECIFICATION DEFINES THE ELECTRICAL AND MECHANICAL CHARACTERISTICS OF THE DC BRUSHLESS BLOWER.

2. CHARACTERS:

ITEM	DESCRIPTION
RATED VOLTAGE	12 VDC
OPERATION VOLTAGE	10.8 – 12.6 VDC
PWM MINIMUM START DUTY 	30% (MAX) @12V, 25KHZ
RATED CURRENT (AVG.)	5.00 (MAX. 6.00) A SAFETY CURRENT ON LABEL : N/A
RATED POWER (AVG.)	60.00 (MAX. 72.00) W
RATED SPEED	7500 ± 10% R.P.M.
MAX. AIR FLOW (AT ZERO STATIC PRESSURE)	1.588 (MIN. 1.429) M ³ /MIN. 56.08 (MIN. 50.47) CFM
MAX. AIR PRESSURE (AT ZERO AIRFLOW)	175.35 (MIN. 142.03) mmH O ₂ 6.903 (MIN. 5.592) inchH O ₂
ACOUSTICAL NOISE (AVG.)	69.0 (MAX. 73.0) dB-A
INSULATION TYPE	UL: CLASS A

(continued)

PART NO:

DELTA MODEL:

BFB1012EF-0018H

INSULATION STRENGTH	10 MEG OHM MIN. AT 500 VDC (BETWEEN FRAME AND (+) TERMINAL)
DIELECTRIC STRENGTH	5 mA MAX. AT 500 VAC 50/60 Hz ONE MINUTE, (BETWEEN FRAME AND (+) TERMINAL)
LIFE EXPECTANCE (L10) (AT LABEL VOLTAGE)	50,000 HOURS CONTINUOUS OPERATION AT 50 °C WITH 15 ~ 65 %RH.
ROTATION	CLOCKWISE VIEW FROM NAME PLATE SIDE
OVER CURRENT SHUT DOWN	THE CURRENT WILL SHUT DOWN WHEN LOCKING ROTOR

- NOTES:
1. ALL READINGS ARE MEASURED AFTER STABLY WARMING UP THROUGH 10 MINUTES.
 2. STANDARD AIR PROPERTY IS AIR AT (Td) 25°C TEMPERATURE, (RH) 65% RELATIVE HUMIDITY, AND (Pb) 760 mmHg BAROMETRIC PRESSURE.
 3. THE VALUES WRITTEN IN PARENS , (), ARE LIMITED SPEC.
 4. ACOUSTICAL NOISE MEASURING CONDITION:

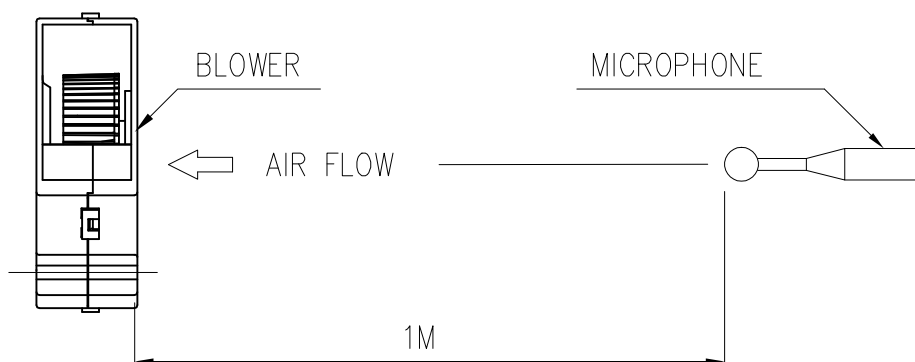

NOISE IS MEASURED AT RATED VOLTAGE IN FREE AIR IN ANECHOIC CHAMBER WITH B & K SOUND LEVEL METER WITH MICROPHONE AT A DISTANCE OF ONE METER FROM THE FAN INTAKE.

PART NO:

DELTA MODEL:

BFB1012EF-0018H

8. P & Q CURVE:

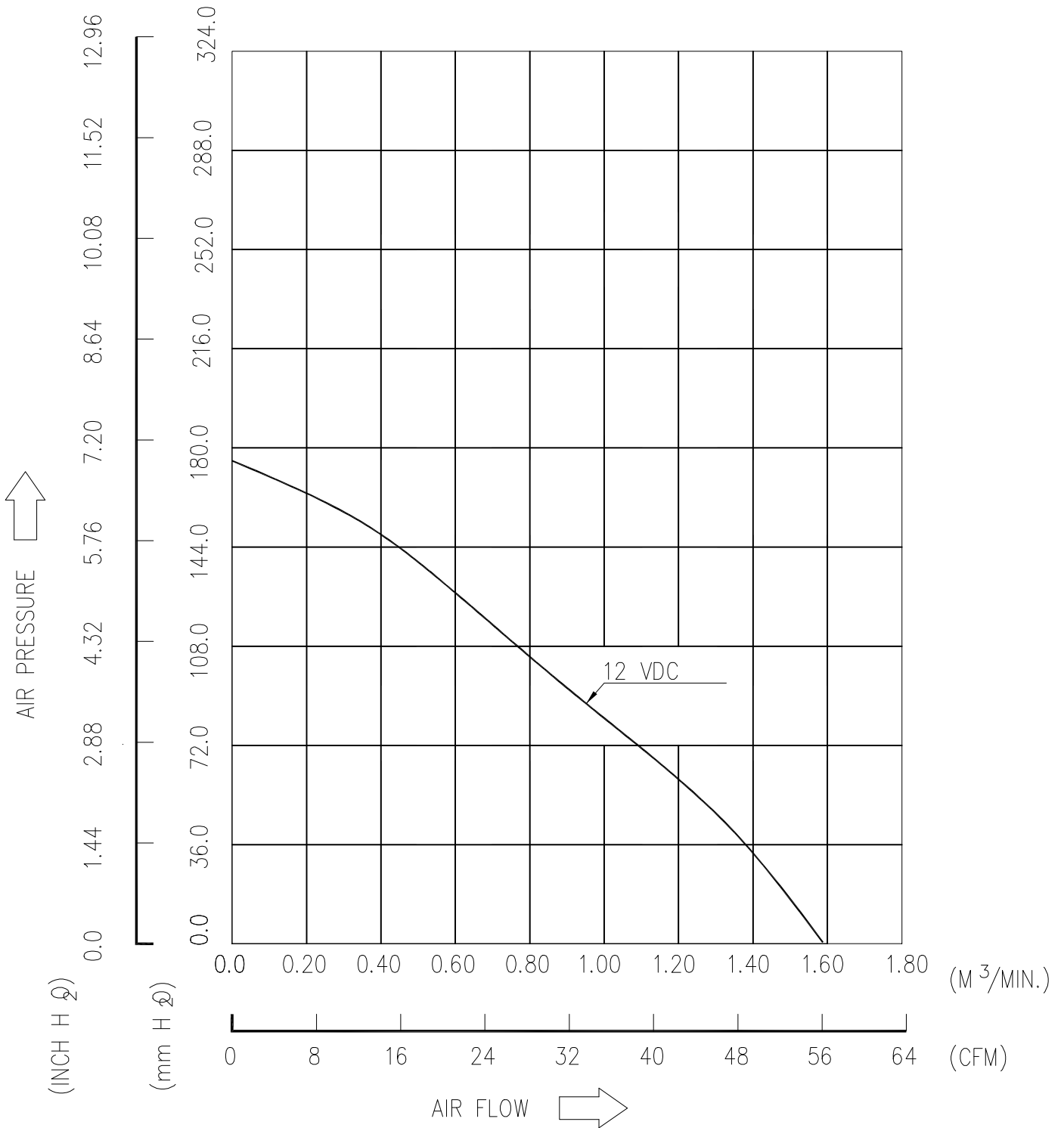

* TEST CONDITION: INPUT VOLTAGE ——— OPERATION VOLTAGE
TEMPERATURE ——— ROOM TEMPERATURE
HUMIDITY ——— 65%RH

PART NO:

DELTA MODEL: BFB1012EF-0018H

9. DIMENSION DRAWING:

 LABEL:

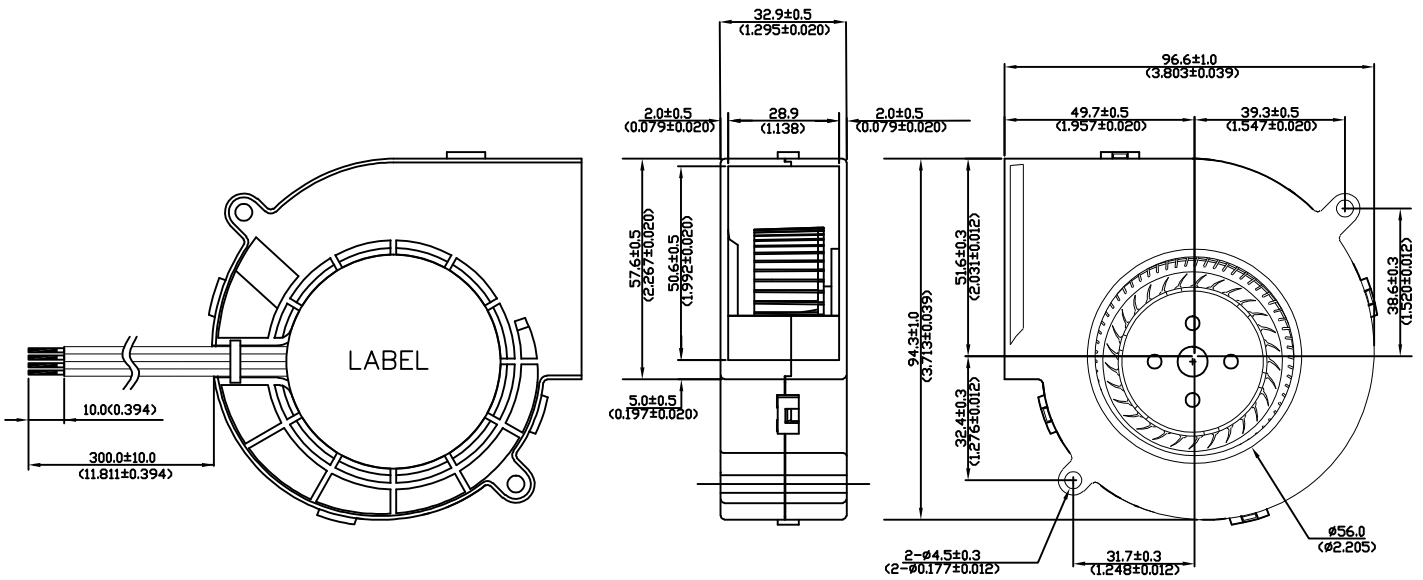
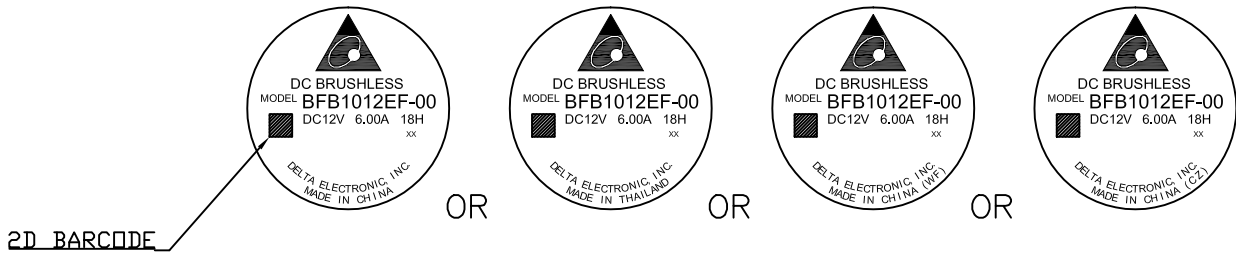

UNIT: mm(INCH)

NOTES:

- 1.WIRE: UL1007 AWG#24
RED WIRE ---- (+)
BLACK WIRE ---- (-)
BLUE WIRE ---- (-FO0)
YELLOW WIRE ---- (PWM)
- 2.THIS PRODUCT IS RoHS COMPLIANT.

PART NO:

DELTA MODEL:

BFB1012EF-0018H

10. FREQUENCY GENERATOR (FG) SIGNAL:

10-1. OUTPUT CIRCUIT - OPEN COLLECTOR MODE:

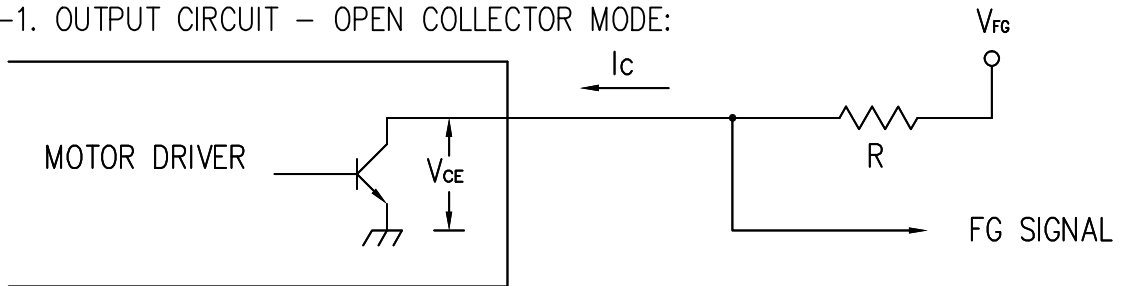

CAUTION:

THE LEAD WIRE OF FG SIGNAL CAN NOT TOUCH
THE LEAD WIRE OF POSITIVE OR NEGATIVE.

10-2. SPECIFICATION:

$V_{CE} (sat) = 0.5V \text{ MAX.}$

$V_{FG} = 5.0 \text{ TYP.}(V_{CC} \text{ MAX.})$

$I_c = 5mA \text{ MAX.}$

$R \geq V_{FG} / I_c$

10-3. FREQUENCY GENERATOR WAVEFORM:

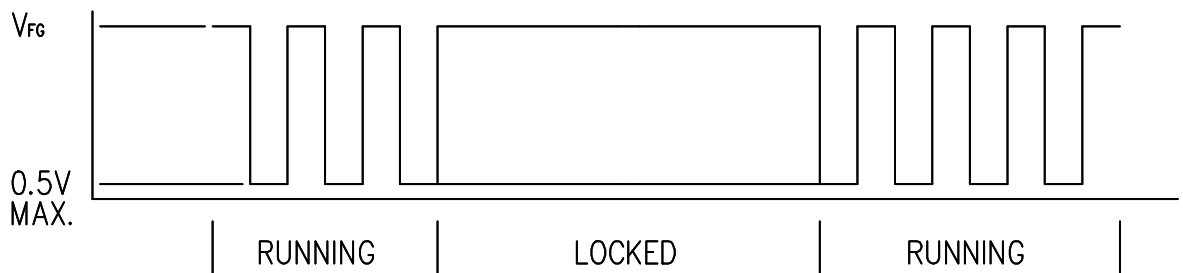

FAN RUNNING FOR 4 POLES

BLADE LOCKED

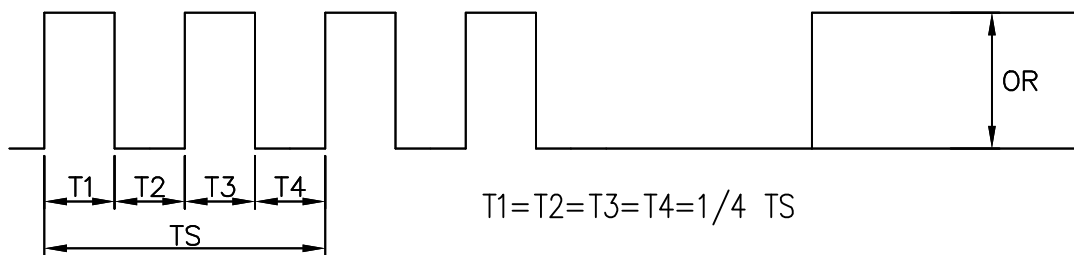

$N = \text{R.P.M}$

$TS = 60/N(\text{SEC})$

*VOLTAGE LEVEL AFTER BLADE LOCKED

*4 POLES

PART NO:

DELTA MODEL:

BFB1012EF-0018H

11. PWM CONTROL SIGNAL:

⚠ SIGNAL VOLTAGE RANGE: 0~5.0 VDC

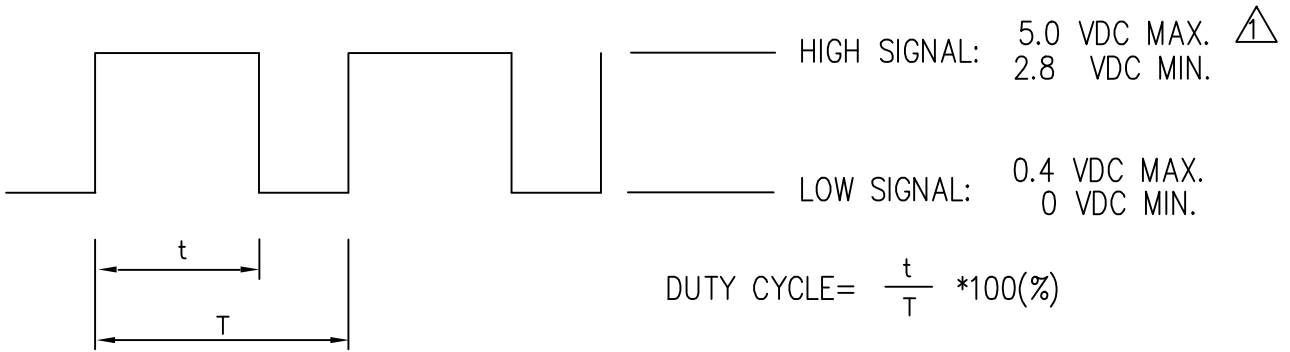

- THE PREFERRED OPERATING POINT FOR THE FAN IS 25KHZ.
- AT 100% DUTY CYCLE, THE ROTOR WILL SPIN AT MAXIMUM SPEED.
- AT 0% DUTY CYCLE, THE ROTOR WILL STOP SPINNING.
- WITH CONTROL SIGNAL LEAD DISCONNECTED, THE FAN WILL SPIN AT MAXIMUM SPEED.
- AT 25K HZ 30% DUTY CYCLE, THE FAN WILL BE ABLE TO START FROM A DEAD STOP .

12. SPEED VS PWM CONTROL SIGNAL: (AT RATED VOLTAGE & PWM FRUQUENCY=25KHZ)

DUTY CYCLE (%)	SPEED R.P.M. (REF.)	CURRENT (A) TYP.
100	7500 ± 10%	5.00
0	0	0.02

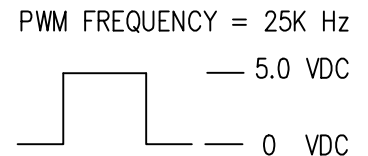

13. PWM CONTROL LEAD WIRE INPUT IMPEDANCE:

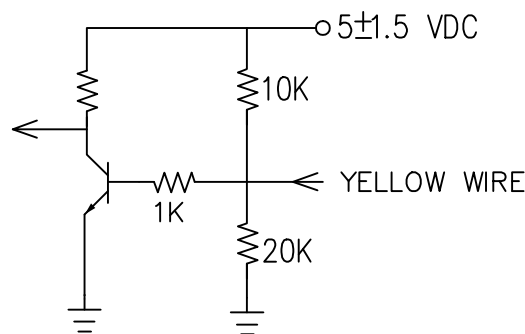

- ⚠ ● MIN. STARTED DUTY CYCLE(AT 25°C & RATED VOLTAGE) : MAX. 30 %
WHEN DUTY CYCLE IS SET FOR MORE THAN 30% THE FAN WILL BE ABLE TO START FROM A DEAD STOP.



Application Notice

- 1. Delta will not guarantee the performance of the products if the application condition falls outside the parameters set forth in the specification.**
- 2. A written request should be submitted to Delta prior to approval if deviation from this specification is required.**
- 3. Please exercise caution when handling fans. Damage may be caused when pressure is applied to the impeller, if the fans are handled by the lead wires, or if the fan was hard-dropped to the production floor.**
- 4. Except as pertains to some special designs, there is no guarantee that the products will be free from any such safety problems or failures as caused by the introduction of powder, droplets of water or encroachment of insect into the hub.**
- 5. The above-mentioned conditions are representative of some unique examples and viewed as the first point of reference prior to all other information.**
- 6. It is very important to establish the correct polarity before connecting the fan to the power source. Positive (+) and Negative (-). Damage may be caused to the fans if connection is with reverse polarity, if there is no foolproof method to protect against such error specifically mentioned in this spec.**
- 7. Delta fans without special protection are not suitable where any corrosive fluids are introduced to their environment.**
- 8. Please ensure all fans are stored according to the storage temperature limits specified. Do not store fans in a high humidity environment. We highly recommend performance testing is conducted before shipping, if the fans have been stored over 6 months.**
- 9. Not all fans are provided with the Lock Rotor Protection feature. If you impair the rotation of the impeller for the fans that do not have this function, the performance of those fans will lead to failure.**
- 10. Please be cautious when mounting the fan. Incorrect mounting of fans may cause excess resonance, vibration and subsequent noise.**
- 11. It is important to consider safety when testing the fans. A suitable fan guard should be fitted to the fan to guard against any potential for personal injury.**
- 12. Except where specifically stated, all tests are carried out at room (ambient) temperature and relative humidity conditions of 25°C, 65% RH. The test value is only for fan performance itself.**
- 13. Be certain to connect an “4.7µF or greater” capacitor to the fan externally when the application calls for using multiple fans in parallel, to avoid any unstable power.**