

SL710 Water Pressure Sensor

SL710 Water Pressure Sensor User Manual

1. General

SL710 series is a low-power water pressure monitoring sensor. The pressure seat is processed with 17-4PH stainless steel one-piece structure, with high overload performance. The pressure interface has no welds, silicone oil or other organic substances, and has good sealing performance. LoRa wireless communication ensure low power consumption, long distance, built-in high-capacity lithium sub battery and long service life. It can be used in low-power wide area IOT scenarios such as water pipe and valve pressure detection.

Sensor Type	Model No.
Water Pressure Sensor	SL710CN, SL710EU,SL710US,SL710AS

Note

CN: LoRaWAN CN470, Frequency: 470~510 MHz

EU: LoRaWAN EU868, Frequency: 863~870 MHz

US: LoRaWAN US915, Frequency: 902~928 MHz

AS: LoRaWAN AS923, Frequency: 920~925 MHz

1.1.Main Features:

- 1.The maximum transmission power is 22dbm, the transmission distance is long, and the open space can reach 3-5 km.
- 2.Built in 19ah high-capacity lithium sub battery, with a service life of more than 5 years.

- 3.The new generation of pressure transmitter is adopted, which has the electrical characteristics of high precision, high reliability and low power consumption.
- 4.Wireless inquiry and modification of configuration parameters are convenient for on-site installation and maintenance.
- 5.Open communication protocol and access to the third-party Lora gateway with simple configuration.
- 6.Full industrial chip design, working temperature range -40 °C ~+85 °C.
- 7.IP66 waterproof design, suitable for harsh industrial environment.

1.2. Parameters

Parameters	Feature
CPU	STM32L151 CPU
Wireless	LoRa (SX1268/SX1262)
Encryption	AES128
Power	Built-in Li-battery (Non-rechargable)
Capacity	19000 mAh
Battery life	8 Years(Data collecting every 5 seconds, data uploading every mins @SF9)
Measure Range	0~3.5 MPa
Precision	±0.5 %FS
Long Time Stability	±0.25 %FS

Parameters	Feature
Respond Time	5 Seconds (e.g data collecting time, configurable)
Communication	Half-duplex
Data Speed	300bps ~ 62.5 kbps
Size	102mm X 60mm X 25mm
Working Temperature	-40°C~85°C
TX Power	Max 22dBm
Sensitivity	-140 dBm
Antenna	SMA
Frequency	SX1268: CN470 SX1262: EU868 / US915 / AS923

1.3. Product Detail



Front

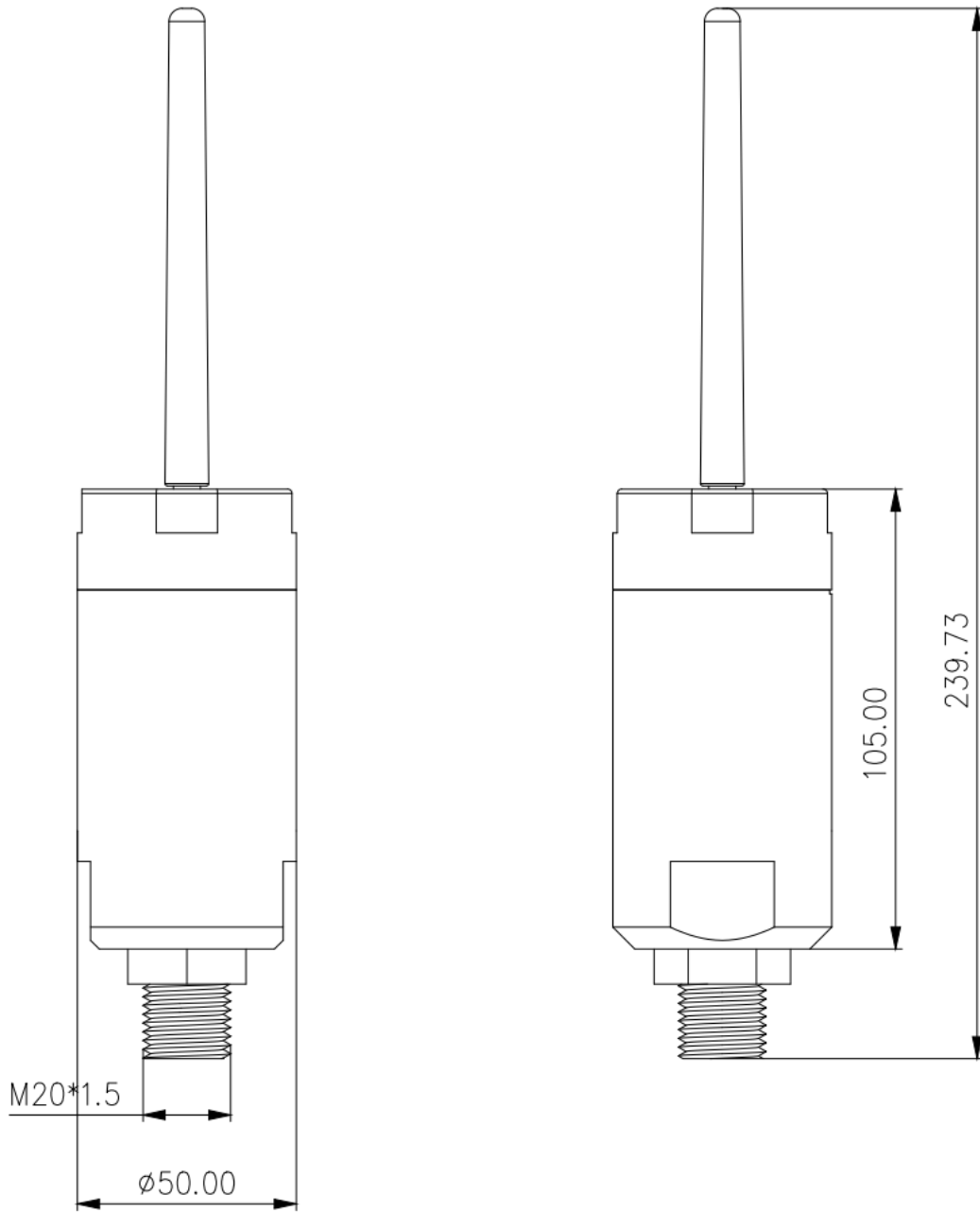

Size

2. Installation

Note:

1. Do not forcibly rotate the cylinder part of the sensor to avoid damaging the internal circuit of the sensor
2. When installing, please use a wrench to twist the hexagon nut part, and do not force the installation through the cylinder part of the sensor.
3. The impulse piping should be as short as possible and avoid sharp bends.
4. The installation slope of impulse piping should not be less than 1:12 to avoid sedimentation.
5. The layout of the impulse piping shall enable the bubbles in the measured liquid or the sediment in the measured gas to flow back to the process piping.
6. During installation, pay attention to the sealing of the interface to avoid oil leakage.

2.1. Magnetic induction trigger

The sensor enters the configuration mode through magnet induction triggering. When there is no magnet close to the magnetic induction area by default, the sensor is in a low-power operation state. When a magnet enters the sensing area, the sensor will trigger a configuration wait mode. (the magnet only needs to be detected once, and it is not necessary or recommended to stay in the sensing area for a long time.)

After entering the configuration waiting mode, the indicator light will remain green. At this time, LoRa dongle can be used for configuration and query. When there is configuration or query operation, the sensor will automatically extend the configuration time by 30s. If there is no operation for 30 seconds, enter the low-power operation mode.

2.2. Indicator

There is one indicator on the sensor with two colors: red and green.

2.2.1. Configuration indicator

while magnetic induction trigger, and in configuration, the indicator is green. While indicator is off, and sensor is in low power mode.

2.2.2. TX Indicator

While the sensor uploading data, and the indicator flushes in green.

2.2.3. Fault Indicator

While there is something wrong with the sensor, the indicator flushed in red.

2.4. Wireless Configuration

When the device enters the configuration mode, it supports wireless at commands and can be configured wirelessly through Rejee USB dongle.

You can use [SensorTool](#) for configuration.

Follow steps below: http://doc.rejee.com/web/#/32?page_id=449

2.5. Antenna

The antenna interface of the equipment adopts standard SMA and the specification of external thread and internal hole. During installation, attention shall be paid to avoiding metal and strong interference equipment. If the installation environment is poor, it is recommended to use a sucker antenna with feeder for installation.

2.6. Data Uploading

When sensor turn on, it will send data immediately.

When the pressure changes more than the set change compared with the last reported data, data uploading immediately.

When the system heartbeat cycle time expires, data uploading.

3. Configuration

3.1. Data check period

The default check period of the system is 5 seconds, the minimum configurable is 1 second, and the maximum configurable is 65553 seconds. The smaller the period is, the more sensitive the response will be, whereas the power consumption will increase.

3.2.Data uplink period

The default data uplink period of the system is 10 minutes (equivalent to heartbeat transmission). For example, in the environment of constant water pressure, the data is uploading every 10 minutes, and this parameter can be adjusted according to the actual situation.

3.3.Calibration

The system does not configure the calibration value by default (i.e. 0). The user can modify the calibration value as needed. Negative numbers are supported. The unit is PA

3.4.Variation

The system does not configure the change amount by default (that is, 0). In the water pressure sensor equipment, because the equipment range is generally large, when the change amount is 0, 5000 PA is automatically used as the change amount in the equipment for logical judgment.

The purpose of the design variation is to support the equipment to judge the variation according to the sampling cycle while reporting it by cycle. When the sampling data and the last sent data exceed the change amount, they will be reported immediately without waiting for the reporting cycle time. In order to support a rapid response to the measured object.

3.5. Connect to LoRaWAN Network

LoRaWAN Network Structure

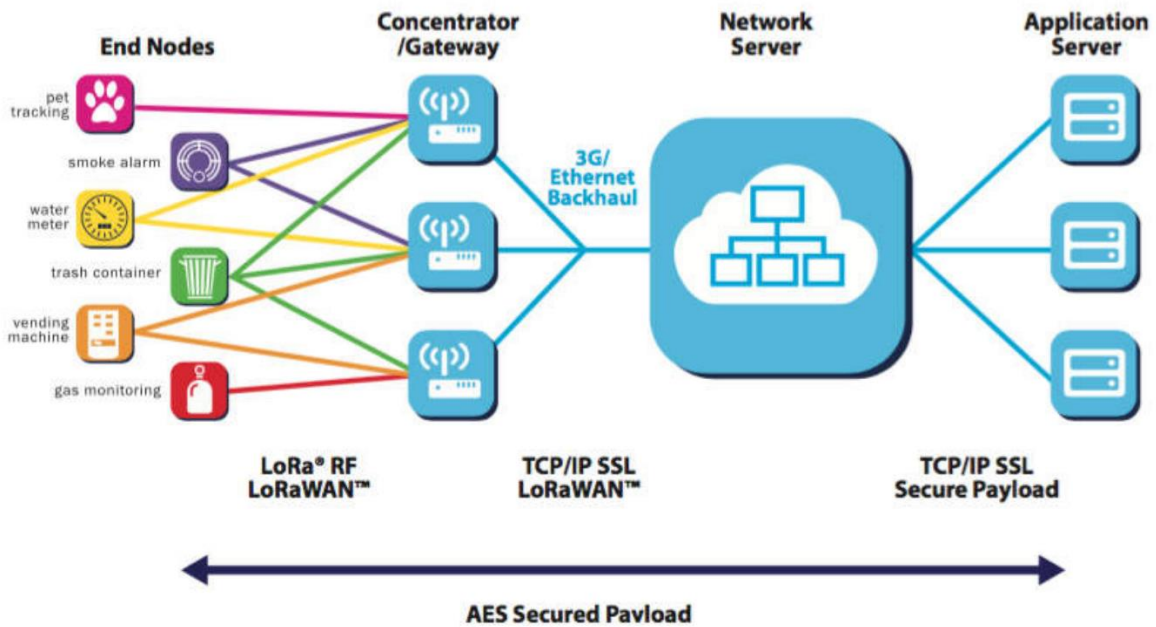

SL710 water pressure sensor is based on standard LoRaWAN Class A/C, so you can connect to any LoRaWAN network through OTAA or ABP.



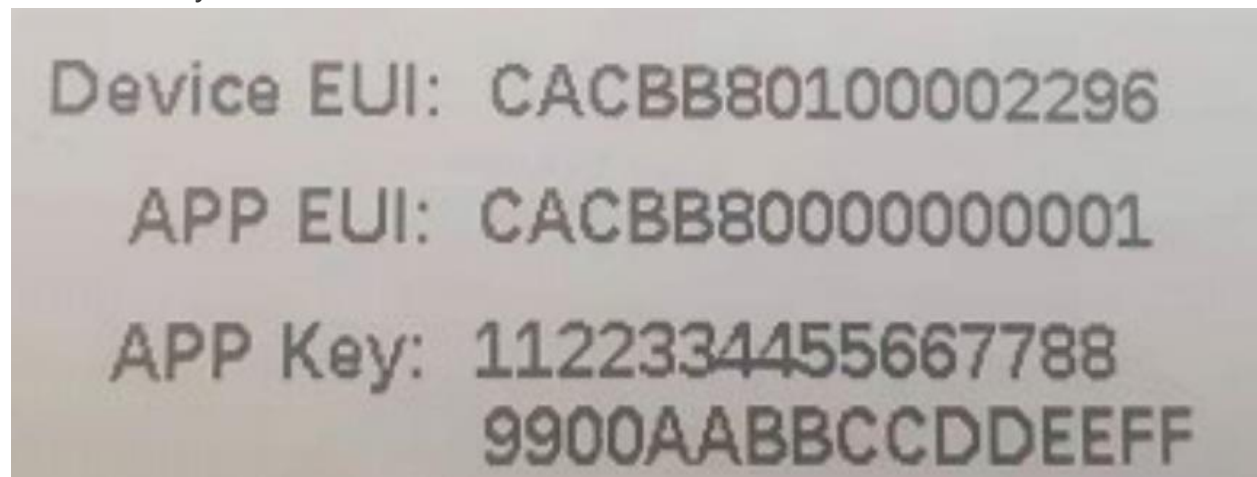



On the package of device, you can find information as below, with this information, you can connect to any LoRaWAN server.



Here below take TTN as an example about how to connect the device to TTN server, please make sure to choose manually and the right frequency plan as below:

Sensor	LoRaWAN
SL710CN	<p data-bbox="574 327 1240 363">From The LoRaWAN Device Repository <u>Manually</u></p> <hr/> <p data-bbox="545 464 797 499">Frequency plan ⓘ *</p> <div data-bbox="545 512 1458 583"><p data-bbox="566 531 911 567">China 470-510 MHz, FSB 11</p><p data-bbox="1409 531 1442 567"> ▼</p></div> <p data-bbox="545 625 824 661">LoRaWAN version ⓘ *</p> <div data-bbox="545 674 1458 745"><p data-bbox="566 693 711 728">MAC V1.0.3</p><p data-bbox="1409 693 1442 728"> ▼</p></div> <p data-bbox="545 787 971 823">Regional Parameters version ⓘ *</p> <div data-bbox="545 835 1458 907"><p data-bbox="566 854 784 890">PHY V1.0.3 REV A</p><p data-bbox="1409 854 1442 890"> ▼</p></div> <hr/> <p data-bbox="545 982 1369 1018"><u>Show advanced activation, LoRaWAN class and cluster settings</u> ^</p> <p data-bbox="545 1081 808 1117">Activation mode ⓘ *</p> <p data-bbox="545 1144 971 1180"><input checked="" type="radio"/> Over the air activation (OTAA)</p>

Sensor	LoRaWAN
SL710EU	<p data-bbox="574 342 829 380">Frequency plan ⓘ *</p> <div data-bbox="574 394 1487 464"><p data-bbox="597 411 1040 449">Europe 863-870 MHz (SF12 for RX2) ▼</p></div> <p data-bbox="574 504 857 541">LoRaWAN version ⓘ *</p> <div data-bbox="574 556 1487 625"><p data-bbox="597 573 740 611">MAC V1.0.3 ▼</p></div> <p data-bbox="574 665 1000 703">Regional Parameters version ⓘ *</p> <div data-bbox="574 718 1487 787"><p data-bbox="597 735 813 772">PHY V1.0.3 REV A ▼</p></div> <hr data-bbox="574 814 1487 819"/> <p data-bbox="574 863 1398 900"><u>Show advanced activation, LoRaWAN class and cluster settings</u> ^</p> <p data-bbox="574 961 841 999">Activation mode ⓘ *</p> <p data-bbox="574 1024 1000 1062"><input checked="" type="radio"/> Over the air activation (OTAA)</p>

Sensor	LoRaWAN
SL710US	<p data-bbox="618 344 1240 380">From The LoRaWAN Device Repository Manually</p> <hr/> <p data-bbox="591 470 829 506">Frequency plan  *</p> <div data-bbox="591 520 1443 583"><p data-bbox="613 533 1179 569">United States 902-928 MHz, FSB 2 (used by TTN) </p></div> <p data-bbox="591 621 857 657">LoRaWAN version  *</p> <div data-bbox="591 669 1443 732"><p data-bbox="613 682 748 718">MAC V1.0.3 </p></div> <p data-bbox="591 770 987 806">Regional Parameters version  *</p> <div data-bbox="591 819 1443 882"><p data-bbox="613 831 816 867">PHY V1.0.3 REV A </p></div> <hr/> <p data-bbox="591 953 1360 989"><u>Show advanced activation, LoRaWAN class and cluster settings</u> ^</p> <p data-bbox="591 1050 841 1085">Activation mode  *</p> <p data-bbox="591 1106 987 1142"><input checked="" data-bbox="591 1106 618 1142" type="radio"/> Over the air activation (OTAA)</p>

Sensor	LoRaWAN
SL710AS	<div style="display: flex; justify-content: space-between; margin-bottom: 10px;"> From The LoRaWAN Device Repository Manually </div> <hr/> <p>Frequency plan ? *</p> <div style="border: 1px solid #ccc; padding: 5px; display: flex; justify-content: space-between; align-items: center;"> Asia 923 MHz with only default channels ▼ </div> <p>LoRaWAN version ? *</p> <div style="border: 1px solid #ccc; padding: 5px; display: flex; justify-content: space-between; align-items: center;"> MAC V1.0.3 ▼ </div> <p>Regional Parameters version ? *</p> <div style="border: 1px solid #ccc; padding: 5px; display: flex; justify-content: space-between; align-items: center; background-color: #f0f0f0;"> PHY V1.0.3 REV A ▼ </div> <hr/> <p><u>Show advanced activation, LoRaWAN class and cluster settings</u> ^</p> <p>Activation mode ? *</p> <p><input checked="" type="radio"/> Over the air activation (OTAA)</p>

3.5.1 Data Configuration

Normally customer only needs to configure the following information under LoRaWAN:

- **Uplink Period:** Data uploading Period, that means sensor collect data and send to gateway

- **Check Period:** Data collecting period, that means sensor collect data but not upload

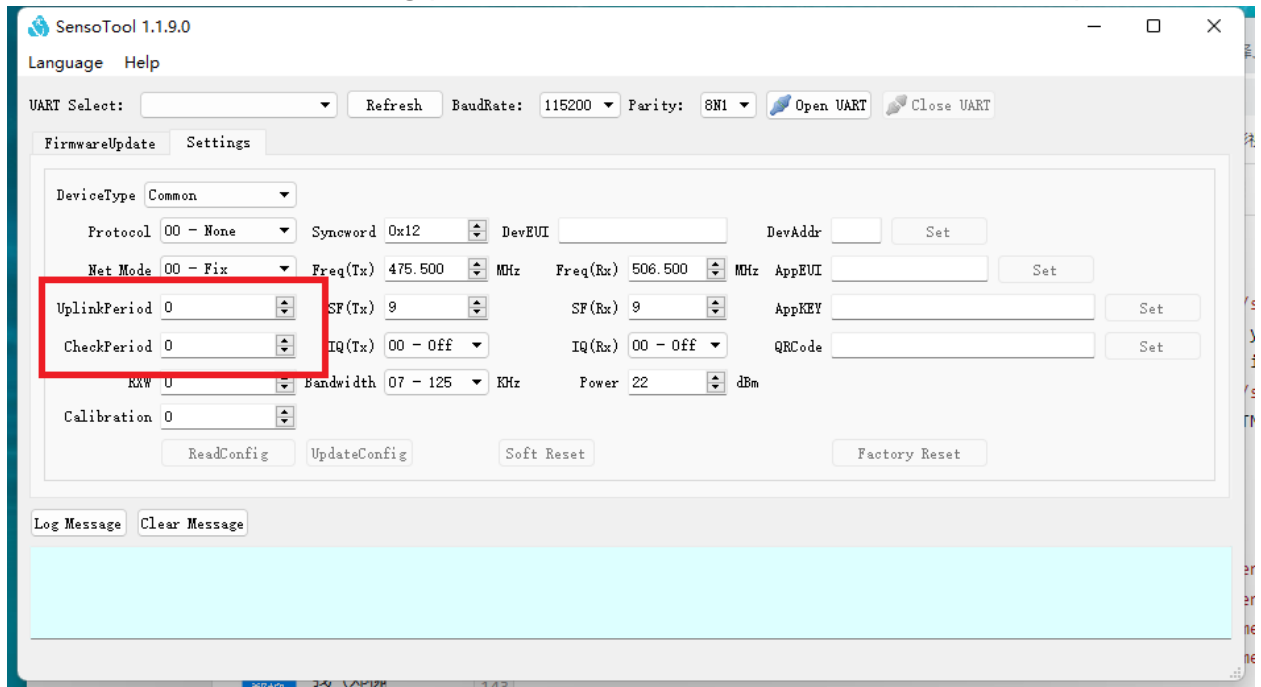

4. Wireless Data Format

4.1 SIP (02/03) — LoRaWAN

MHDR	FHDR	FPort	FRMPayload=Sensor Data(Message)			MIC 4 Bytes
			Data 1	...	Data N	
			Type+Data N Bytes	Type+Data N Bytes	Type+Data N Bytes	

FPort: 1

FRMPayload: e.g sensor data(Message Body)

Refer to [Rejeev sensor data](#).

4.2 Sensor Data

4.2.1 Device Information (0x00)

Type	Value	Value	Value
1 Byte	3 bit	5bit	1 Byte
0x00	Version	Battery Level	Reserve

4.2.3.Pressure (0x07)

Type 1 Byte	Value 4 Bytes	Note
0x07	Pressure	4-byte signed integer, default unit

5.Feature Test

		功耗/次数			
运行时间(天)	1				
采样周期LCP(秒)	5	17280	次		
上报周期LFT(秒)	600	144	次		
扩频因子SF	9				
发送时长	0.225	s			
采样时长	35	ms			
发送平均电流	140	mA			
采样电流	9	mA			
休眠平均电流	0.006	mA			
单次采样功耗	0.0875	uAh			
单次发送功耗	8.75	uAh			
			占比	1年功耗	
采样功耗	1.512	mAh	51.85%	551.88	mAh
发送功耗	1.26	mAh	43.21%	459.9	mAh
休眠功耗	0.144	mAh	4.94%	52.56	mAh
预计总功耗	2.916	mAh		1064.34	mAh

5.1.Standby Current



Pic: Standby Current

5.2. Sensor TX Current

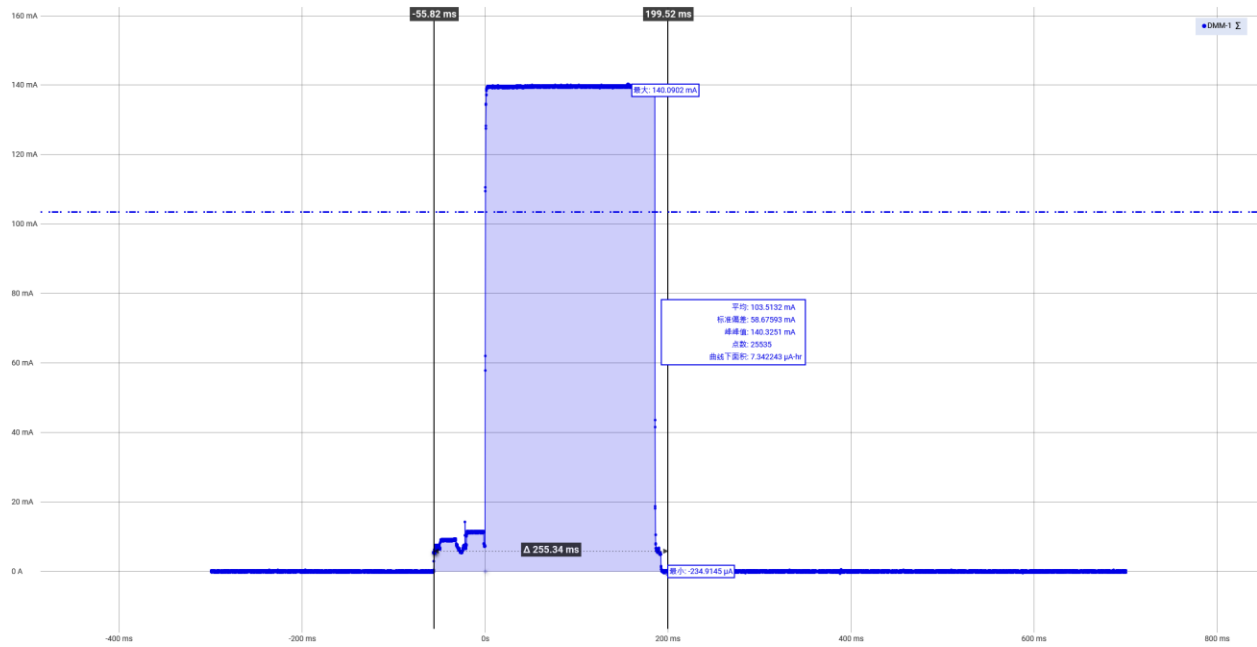

Pic: TX Current (SF9)

5.3.Sensitivity Test

扩频因子 SF	接收灵敏度 dBm, @BW=125K, 470MHz
SF=7	-126
SF=8	-129
SF=9	-131
SF=10	-134
SF=11	-136
SF=12	-139

5.4.TX Power Test

```
16. }  
17. return crc16; }
```