

ABC856AW-HF Thru. ABC858CW-HF (PNP)

RoHS Device
Halogen Free

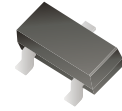

Features

- For AF input stages and driver applications.
- High current gain.
- Low collector-emitter saturation voltage.
- Low noise between 30Hz and 15kHz.
- AEC-Q101 Qualified.

Mechanical data

- Case: SOT-323, molded plastic.

Circuit Diagram

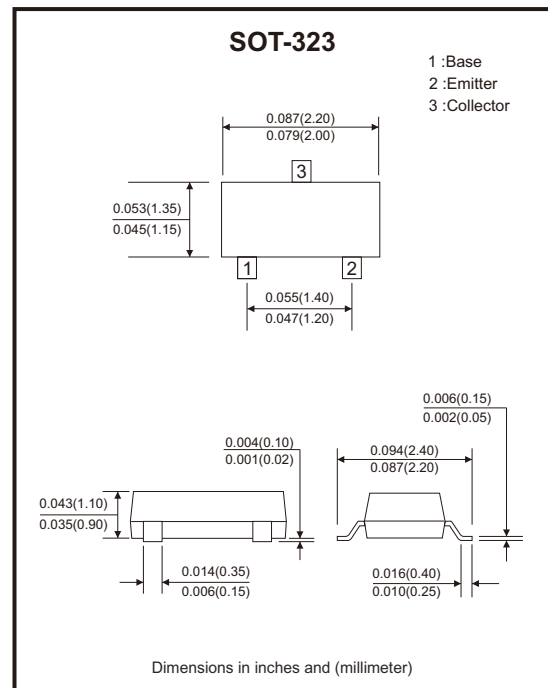
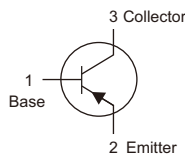

Maximum Ratings (Ta=25°C unless otherwise noted)

Parameter	Symbol	Value	Unit
Collector-base voltage	V _{CBO}	ABC856W-HF -80	V
		ABC857W-HF -50	
		ABC858W-HF -30	
Collector-emitter voltage	V _{CEO}	ABC856W-HF -65	V
		ABC857W-HF -45	
		ABC858W-HF -30	
Emitter-base voltage	V _{EBO}	-5	V
Collector current-continuous	I _C	-100	mA
Peak collector current	I _{CM}	-200	mA
Peak base current	I _{BM}	-200	mA
Collector dissipation	P _C	200	mW
Junction and storage temperature range	T _J , T _{STG}	-65 to +150	°C

Electrical Characteristics (Ta= 25°C unless otherwise specified)

Parameter	Symbol	Test Conditions	Min.	Typ.	Max.	Unit
Collector-base breakdown voltage	$V_{(BR)CBO}$	$I_C = -10\mu A, I_E = 0$	-80 -50 -30			V
Collector-emitter breakdown voltage	$V_{(BR)CEO}$	$I_C = -10mA, I_B = 0$	-65 -45 -30			V
Emitter-base breakdown voltage	$V_{(BR)EBO}$	$I_E = -1\mu A, I_C = 0$	-5			V
Collector cut-off current	I_{CBO}	$V_{CB} = -30V, I_E = 0$			-15	nA
Emitter cut-off current	I_{EBO}	$V_{EB} = -5V, I_C = 0$			-0.1	μA
DC current gain	h_{FE}	$V_{CE} = -5V, I_C = -10\mu A$		140 250 480		
DC current gain	h_{FE}	$V_{CE} = -5V, I_C = -2mA$	125 220 420	180 290 520	250 475 800	
Collector-emitter saturation voltage	$V_{CE(sat)}$	$I_C = -10mA, I_B = -0.5mA$ $I_C = -100mA, I_B = -5mA$		-0.075 -0.25	-0.3 -0.65	V
Base-emitter saturation voltage	$V_{BE(sat)}$	$I_C = -10mA, I_B = -0.5mA$ $I_C = -100mA, I_B = -5mA$		-0.7 -0.85		V
Base-emitter voltage	$V_{BE(on)}$	$I_C = -2mA, V_{CE} = 5V$ $I_C = -10mA, V_{CE} = 5V$	-0.6 -		-0.75 -0.82	V
Transition frequency	f_T	$V_{CE} = -5V, I_C = -20mA, f = 100MHz$		250		MHz
Collector-base capacitance	C_{cb}	$V_{CB} = -10V, f = 1MHz$		3	5	pF
Emitter-base capacitance	C_{eb}	$V_{EB} = -0.5V, f = 1MHz$		10	15	pF

Rating and Characteristic Curves (ABC856AW-HF Thru. ABC858CW-HF)

Fig.1 - Total Power Dissipation

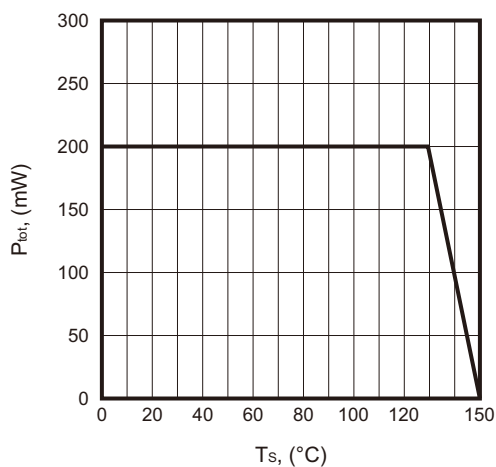
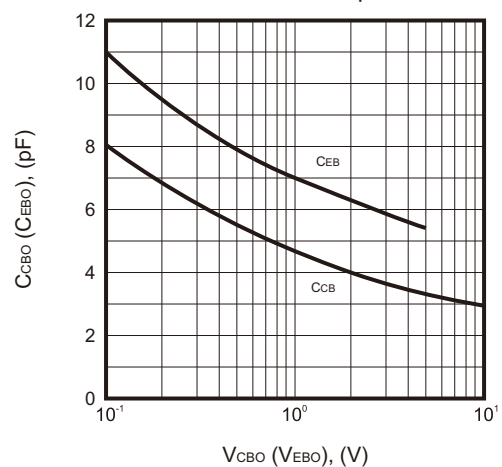

Fig.2 - Collector-Base Capacitance
Emitter-Base Capacitance



Company reserves the right to improve product design, functions and reliability without notice.

REV:A

Rating and Characteristic Curves (ABC856AW-HF Thru. ABC858CW-HF)

Fig.3 - Transition Frequency

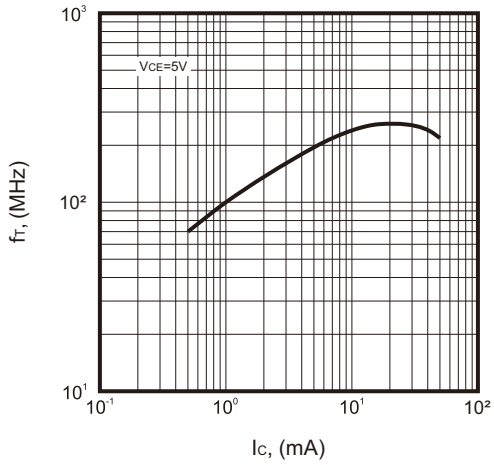

Fig.4 - Collector Cutoff Current

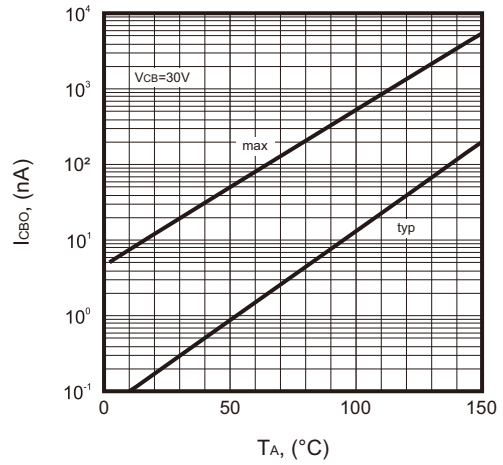

Fig.5 - Collector-Emitter Saturation Voltage

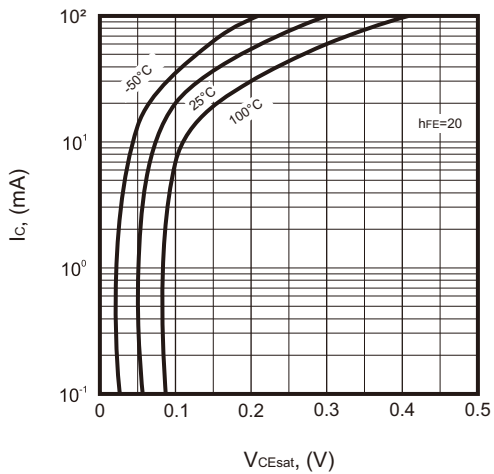

Fig.6 - DC Current Gain

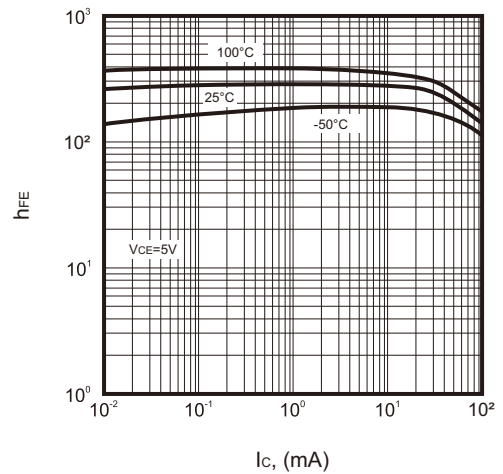
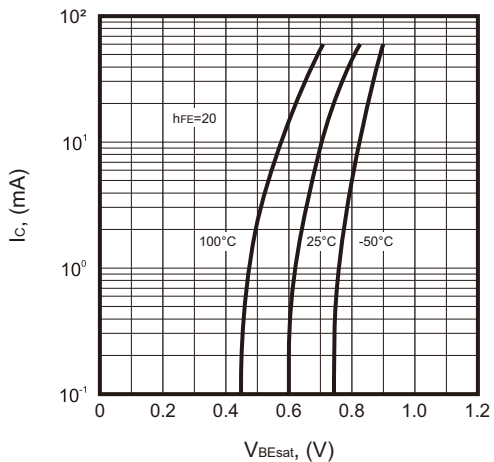

Fig.7 - Base-Emitter Saturation Voltage



Company reserves the right to improve product design, functions and reliability without notice.

REV:A

Reel Taping Specification

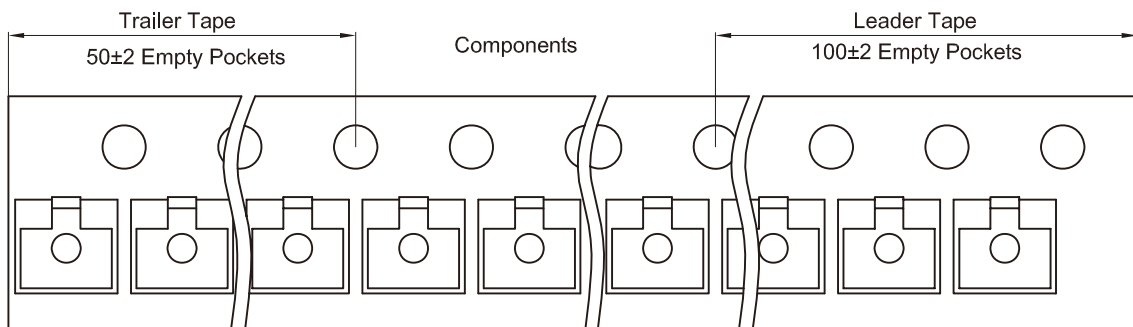
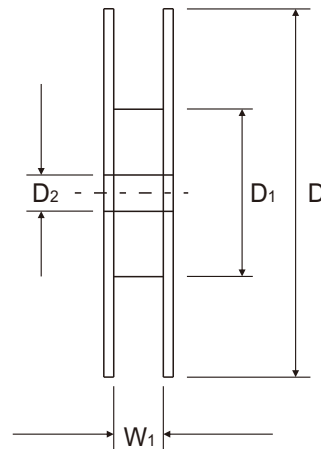
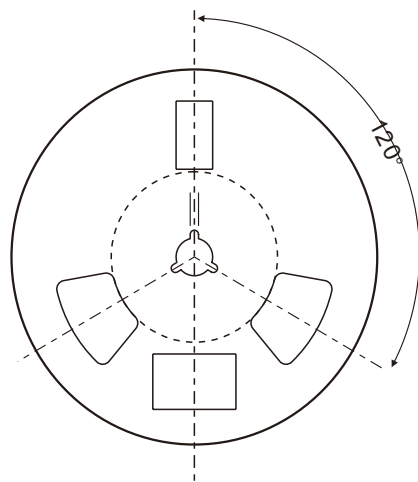
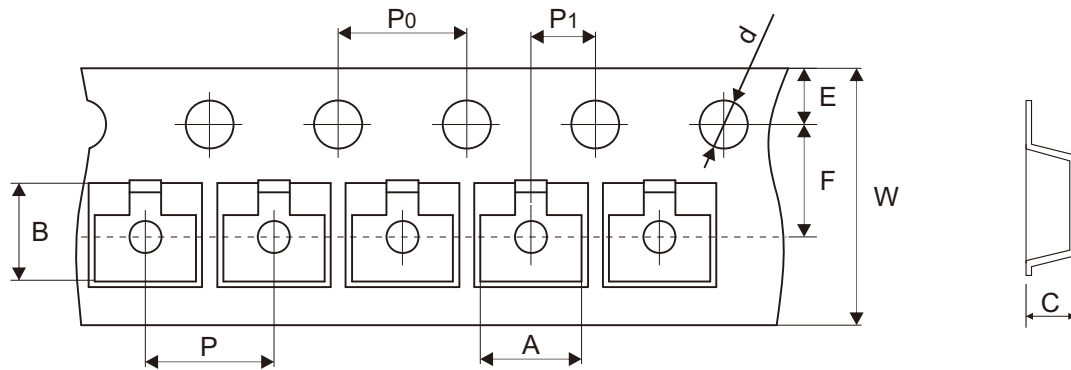

SOT-323	SYMBOL	A	B	C	d	D	D1	D2
	(mm)	2.25 ± 0.10	2.55 ± 0.10	1.20 ± 0.10	1.50 ± 0.10	178.00 ± 1.00	54.00 ± 0.50	13.00 ± 0.50
	(inch)	0.089 ± 0.004	0.100 ± 0.004	0.047 ± 0.004	0.059 ± 0.004	7.008 ± 0.039	2.126 ± 0.020	0.512 ± 0.020

SOT-323	SYMBOL	E	F	P	P0	P1	W	W1
	(mm)	1.75 ± 0.10	3.50 ± 0.05	4.00 ± 0.10	4.00 ± 0.10	2.00 ± 0.05	8.00 + 0.30 - 0.10	9.50 ± 1.00
	(inch)	0.069 ± 0.004	0.138 ± 0.002	0.157 ± 0.004	0.157 ± 0.004	0.079 ± 0.002	0.315 + 0.012 - 0.004	0.374 ± 0.039

Company reserves the right to improve product design, functions and reliability without notice.

REV:A

Marking Code

Part Number	Marking Code
ABC856AW-HF	3A
ABC857AW-HF	3E
ABC858AW-HF	3J
ABC856BW-HF	3B
ABC857BW-HF	3F
ABC858BW-HF	3K
ABC857CW-HF	3G
ABC858CW-HF	3L

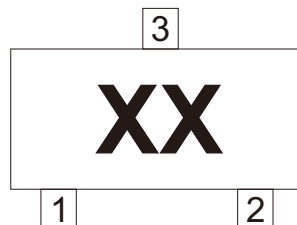

xx = Product type marking code

Suggested P.C.B. PAD Layout

SIZE	SOT-323	
	(mm)	(inch)
A	0.90	0.035
B	0.70	0.028
C	1.30	0.051
D	1.90	0.075

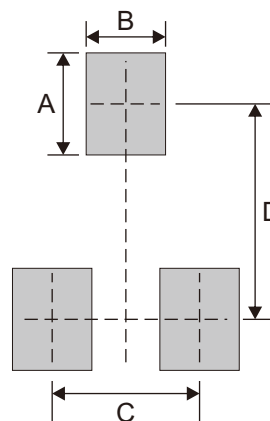

Note: 1. The pad layout is for reference purposes only.

Standard Packaging

Case Type	REEL PACK	
	REEL (pcs)	Reel Size (inch)
SOT-323	3,000	7