

**Data sheet | Item number: 2002-2602**

Double-deck terminal block; Through/through terminal block; same profile as double-deck disconnect terminal block; N/L; without marker carrier; Blue conductor entry lower deck; for DIN-rail 35 x 15 and 35 x 7.5; 2.5 mm<sup>2</sup>; Push-in CAGE CLAMP®; 2,50 mm<sup>2</sup>; gray

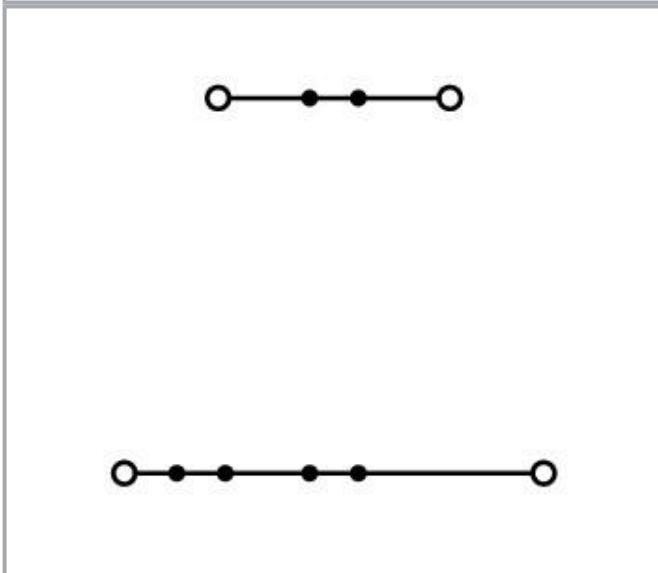

[www.wago.com/2002-2602](http://www.wago.com/2002-2602)

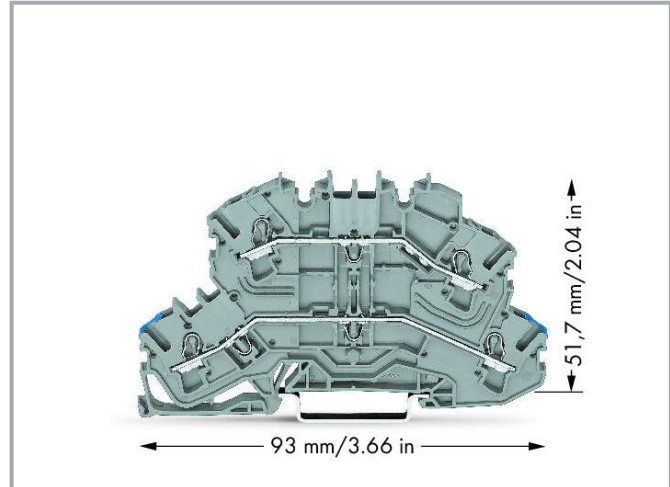
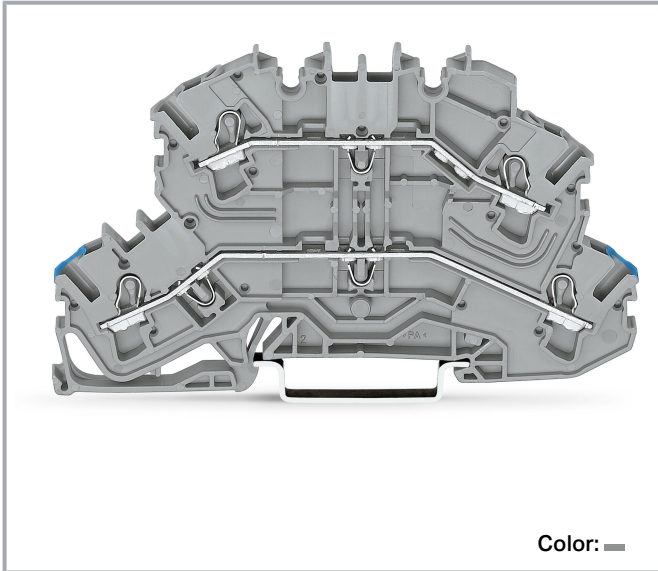

**Data**  
**Electrical data**

Subject to changes. Please also observe the further product documentation!

WAGO GmbH & Co. KG  
Hansastr. 27  
32423 Minden  
Phone: +49571 887-0 | Fax: +49571 887-169  
Email: [info.de@wago.com](mailto:info.de@wago.com) | Web: [www.wago.com](http://www.wago.com)

Do you have any questions about our products?  
We are always happy to take your call at +49 (571) 887-44222.



### Ratings per IEC/EN

|   |   |
|---|---|
| Ratings per   | IEC/EN 60947-7-1  |
| Nominal voltage (III/3)                                   | 500 V   |
| Rated impulse voltage (III/3)                             | 6 kV  |
| Rated current   | 24 A  |
| Current at conductor cross-section (max.) mm <sup>2</sup> | 28 A  |
| Legend (ratings)  | (III / 3) $\hat{=}$ Overvoltage category III / Pollution degree 3 |

### Ratings per UL 1059

|                                |         |
|--------------------------------|---------|
| Approvals per                  | UL 1059 |
| Rated voltage UL (Use Group B) | 300 V   |
| Rated current UL (Use Group B) | 20 A    |
| Rated voltage UL (Use Group C) | 300 V   |
| Rated current UL (Use Group C) | 20 A    |

### Ratings per CSA

|                                 |                 |
|---------------------------------|-----------------|
| Approvals per                   | CSA 22.2 No 158 |
| Rated voltage CSA (Use Group B) | 300 V           |
| Rated current CSA (Use Group B) | 20 A            |
| Rated voltage CSA (Use Group C) | 300 V           |
| Rated current CSA (Use Group C) | 20 A            |

### Ex information

|                            |   |
|----------------------------|---|
| Reference hazardous areas  | See "Downloads – Documentation – Additional Information: Technical Section; Technical Explications" |
| Ratings per                | ATEX: KIWA 17 ATEX 0030 U / IECEx: KIWA 17.0014U (Ex ec IIC Gc)                                     |
| Rated voltage EN (Ex e II) | 440 V   |
| Rated current (Ex e II)    | 14 A  |

### Power loss

|  |                |
|--|----------------|
| Power loss, per pole (potential)                             | 0.766 W        |
| Rated current $I_N$ for specified power loss                 | 24 A           |
| Resistance value for specified, current-dependent power loss | 0.001 $\Omega$ |

Subject to changes. Please also observe the further product documentation!



## Connection data

|                              |   |
|------------------------------|---|
| Connection points            | 4 |
| Total number of potentials   | 2 |
| Number of levels             | 2 |
| Number of jumper slots       | 4 |
| Anzahl Brückeraufnahmen Rang | 1 |

## Connection 1

|  |   |
|--|---|
| Connection technology                                      | Push-in CAGE CLAMP®   |
| Number of connection points                                | 2   |
| Actuation type   | Operating tool  |
| Connectable conductor materials                            | Copper  |
| Nominal cross-section                                      | 2.5 mm <sup>2</sup>   |
| Solid conductor  | 0.25 ... 4 mm <sup>2</sup> / 22 ... 12 AWG  |
| Solid conductor; push-in termination                       | 0.75 ... 4 mm <sup>2</sup> / 18 ... 12 AWG  |
| Fine-stranded conductor                                    | 0.25 ... 4 mm <sup>2</sup> / 22 ... 12 AWG  |
| Fine-stranded conductor; with insulated ferrule            | 0.25 ... 2.5 mm <sup>2</sup> / 22 ... 14 AWG  |
| Fine-stranded conductor; with ferrule; push-in termination | 1 ... 2.5 mm <sup>2</sup> / 18 ... 14 AWG   |
| Note (conductor cross-section)                             | Depending on the conductor characteristic, a conductor with a smaller cross-section can also be inserted via push-in termination. |
| Strip length   | 10 ... 12 mm / 0.39 ... 0.47 inches   |
| Wiring direction   | Front-entry wiring  |

## Connection 2

|                               |   |
|-------------------------------|---|
| Number of connection points 2 | 2 |
|-------------------------------|---|

## Physical data

|                                   |                        |
|-----------------------------------|------------------------|
| Width                             | 5.2 mm / 0.205 inches  |
| Height                            | 93 mm / 3.661 inches   |
| Depth from upper-edge of DIN-rail | 51.7 mm / 2.035 inches |

## Mechanical Data

|                   |                     |
|-------------------|---------------------|
| Potential marking | N/L                 |
| Mounting type     | DIN-35 rail         |
| Marking level     | Center/side marking |

Subject to changes. Please also observe the further product documentation!

WAGO GmbH & Co. KG  
 Hansastr. 27  
 32423 Minden  
 Phone: +49571 887-0 | Fax: +49571 887-169  
 Email: [info.de@wago.com](mailto:info.de@wago.com) | Web: [www.wago.com](http://www.wago.com)

Do you have any questions about our products?  
 We are always happy to take your call at +49 (571) 887-44222.



## Material Data

Note (material data)

Information on material specifications can be found here

|                             |                  |
|-----------------------------|------------------|
| Color                       | gray             |
| Material group              | I                |
| Insulation material         | Polyamide (PA66) |
| Flammability class per UL94 | V0               |
| Fire load                   | 0.264 MJ         |
| Weight                      | 13.9 g           |

## Environmental requirements

|                                  |                 |
|----------------------------------|-----------------|
| Processing temperature           | -35 ... +85 °C  |
| Continuous operating temperature | -60 ... +105 °C |

## Commercial data

|                       |               |
|-----------------------|---------------|
| Product Group         | 22 (TOPJOB S) |
| eCl@ss 10.0           | 27-14-11-20   |
| eCl@ss 9.0            | 27-14-11-20   |
| ETIM 8.0              | EC000897      |
| ETIM 7.0              | EC000897      |
| PU (SPU)              | 50 pcs        |
| Packaging type        | box           |
| Country of origin     | DE            |
| GTIN                  | 4050821403814 |
| Customs tariff number | 85369010000   |

## Environmental Product Compliance

|                        |                         |
|------------------------|-------------------------|
| RoHS Compliance Status | Compliant, No Exemption |
|------------------------|-------------------------|

## Approvals / Certificates

### General approvals



| Logo | Approval                        | Additional Approval Text | Certificate name |
|------|---------------------------------|--------------------------|------------------|
|      | CCA<br>DEKRA Certification B.V. | EN 60947                 | 71-<br>120369    |

Subject to changes. Please also observe the further product documentation!



WAGO GmbH & Co. KG  
Hansastr. 27  
32423 Minden  
Phone: +49571 887-0 | Fax: +49571 887-169  
Email: [info.de@wago.com](mailto:info.de@wago.com) | Web: [www.wago.com](http://www.wago.com)

Do you have any questions about our products?  
We are always happy to take your call at +49 (571) 887-44222.





|  |                                      |               |                |
|--|--------------------------------------|---------------|----------------|
|  | CCA<br>DEKRA Certification B.V.      | EN 60947      | NTR NL<br>7892 |
|  | CSA<br>DEKRA Certification B.V.      | C22.2 No. 158 | 1536069        |
|  | UL<br>Underwriters Laboratories Inc. | UL 1059       | E45172         |

## Declarations of conformity and manufacturer's declarations

| Logo   | Approval   | Additional Approval Text | Certificate name |
|--|--|--------------------------|------------------|
|   | EU-Declaration of Conformity<br>WAGO GmbH & Co. KG | -                        | -                |
|  | Railway<br>WAGO GmbH & Co. KG                      | -                        | Railway<br>Ready |
|  | UK-Declaration of Conformity<br>WAGO GmbH & Co. KG | -                        | -                |

## Approvals for marine applications

| Logo   | Approval   | Additional Approval Text | Certificate name         |
|--|--|--------------------------|--------------------------|
|  | ABS<br>American Bureau of Shipping               | EN 60947                 | 20-<br>HG1941090-<br>PDA |
|  | DNV GL<br>Det Norske Veritas, Germanischer Lloyd | -                        | TAE00001V2               |



Subject to changes. Please also observe the further product documentation!

WAGO GmbH & Co. KG  
Hansastr. 27  
32423 Minden  
Phone: +49571 887-0 | Fax: +49571 887-169  
Email: [info.de@wago.com](mailto:info.de@wago.com) | Web: [www.wago.com](http://www.wago.com)

Do you have any questions about our products?  
We are always happy to take your call at +49 (571) 887-44222.

## Required accessories

### End plate

| End plate  |  |  |
|--|--|--|
|  | <b>Item no.: 2002-2691</b><br>End and intermediate plate; 1 mm thick; gray   | <a href="http://www.wago.com/2002-2691">www.wago.com/2002-2691</a> |
|  | <b>Item no.: 2002-2692</b><br>End and intermediate plate; 1 mm thick; orange | <a href="http://www.wago.com/2002-2692">www.wago.com/2002-2692</a> |

## Optional accessories

### Carrier rail

| Mounting accessories   |  |  |
|--|--|--|
|    | <b>Item no.: 210-197</b><br>Steel carrier rail; 35 x 15 mm; 1.5 mm thick; 2 m long; slotted; similar to EN 60715; silver-colored                     | <a href="http://www.wago.com/210-197">www.wago.com/210-197</a> |
|    | <b>Item no.: 210-198</b><br>Copper carrier rail; 35 x 15 mm; 2.3 mm thick; 2 m long; unslotted; according to EN 60715; copper-colored                | <a href="http://www.wago.com/210-198">www.wago.com/210-198</a> |
|   | <b>Item no.: 210-504</b><br>Steel carrier rail; 35 x 7.5 mm; 1 mm thick; 2 m long; slotted; galvanized; according to EN 60715; silver-colored        | <a href="http://www.wago.com/210-504">www.wago.com/210-504</a> |
|  | <b>Item no.: 210-505</b><br>Steel carrier rail; 35 x 7.5 mm; 1 mm thick; 2 m long; unslotted; galvanized; according to EN 60715; silver-colored      | <a href="http://www.wago.com/210-505">www.wago.com/210-505</a> |
|  | <b>Item no.: 210-506</b><br>Steel carrier rail; 35 x 15 mm; 1.5 mm thick; 2 m long; unslotted; galvanized; similar to EN 60715; silver-colored       | <a href="http://www.wago.com/210-506">www.wago.com/210-506</a> |
|  | <b>Item no.: 210-508</b><br>Steel carrier rail; 35 x 15 mm; 1.5 mm thick; 2 m long; slotted; galvanized; similar to EN 60715; silver-colored         | <a href="http://www.wago.com/210-508">www.wago.com/210-508</a> |
|  | <b>Item no.: 210-113</b><br>Steel carrier rail; 35 x 7.5 mm; 1 mm thick; 2 m long; unslotted; according to EN 60715; silver-colored                  | <a href="http://www.wago.com/210-113">www.wago.com/210-113</a> |
|  | <b>Item no.: 210-118</b><br>Steel carrier rail; 35 x 15 mm; 2.3 mm thick; 2 m long; unslotted; according to EN 60715; silver-colored                 | <a href="http://www.wago.com/210-118">www.wago.com/210-118</a> |
|  | <b>Item no.: 210-112</b><br>Steel carrier rail; 35 x 7.5 mm; 1 mm thick; 2 m long; slotted; according to EN 60715; "Hole width 25 mm; silver-colored | <a href="http://www.wago.com/210-112">www.wago.com/210-112</a> |
|  | <b>Item no.: 210-114</b><br>Steel carrier rail; 35 x 15 mm; 1.5 mm thick; 2 m long; unslotted; similar to EN 60715; silver-colored                   | <a href="http://www.wago.com/210-114">www.wago.com/210-114</a> |

Subject to changes. Please also observe the further product documentation!



**Item no.: 210-115**

Steel carrier rail; 35 x 7.5 mm; 1 mm thick; 2 m long; slotted; according to EN 60715; "Hole width 18 mm; [www.wago.com/210-115](http://www.wago.com/210-115)  
silver-colored



**Item no.: 210-196**

Aluminum carrier rail; 35 x 8.2 mm; 1.6 mm thick; 2 m long; unslotted; similar to EN 60715; silver-colored [www.wago.com/210-196](http://www.wago.com/210-196)

### End plate

End plate



**Item no.: 209-192**

Separator for Ex e/Ex i applications; 3 mm thick; 125.5 mm wide; orange

[www.wago.com/209-192](http://www.wago.com/209-192)

### Mounting

Cover carrier



**Item no.: 709-169**

Cover carrier; Type 3; gray

[www.wago.com/709-169](http://www.wago.com/709-169)

Cover



**Item no.: 709-156**

Cover; Type 3; suitable for cover carrier, type 3; 1 m long; transparent

[www.wago.com/709-156](http://www.wago.com/709-156)

### Jumpers

Jumper



**Item no.: 210-123**

Wire commoning chain; insulated; blue

[www.wago.com/210-123](http://www.wago.com/210-123)



**Item no.: 2002-402**

Jumper; 2-way; insulated; light gray

[www.wago.com/2002-402](http://www.wago.com/2002-402)



**Item no.: 2002-402/000-005**

Jumper; 2-way; insulated; red

[www.wago.com/2002-402/000-005](http://www.wago.com/2002-402/000-005)



**Item no.: 2002-400**

Continuous jumper; 2-way; insulated; light gray

[www.wago.com/2002-400](http://www.wago.com/2002-400)



**Item no.: 2002-403**

Jumper; 3-way; insulated; light gray

[www.wago.com/2002-403](http://www.wago.com/2002-403)



**Item no.: 2002-404/000-005**

Jumper; 4-way; insulated; red

[www.wago.com/2002-404/000-005](http://www.wago.com/2002-404/000-005)



**Item no.: 2002-403/000-006**

Jumper; 3-way; insulated; blue

[www.wago.com/2002-403/000-006](http://www.wago.com/2002-403/000-006)



**Item no.: 2002-404/000-006**

Jumper; 4-way; insulated; blue

[www.wago.com/2002-404/000-006](http://www.wago.com/2002-404/000-006)

Subject to changes. Please also observe the further product documentation!

WAGO GmbH & Co. KG

Hansastr. 27













32423 Minden

Phone: +49571 887-0 | Fax: +49571 887-169

Email: [info.de@wago.com](mailto:info.de@wago.com) | Web: [www.wago.com](http://www.wago.com)

Do you have any questions about our products?

We are always happy to take your call at +49 (571) 887-44222.

|  |  |  |
|--|--|--|
|     | <b>Item no.: 2002-403/000-005</b><br>Jumper; 3-way; insulated; red       | <a href="http://www.wago.com/2002-403/000-005">www.wago.com/2002-403/000-005</a> |
|    | <b>Item no.: 2002-405/000-005</b><br>Jumper; 5-way; insulated; red       | <a href="http://www.wago.com/2002-405/000-005">www.wago.com/2002-405/000-005</a> |
|     | <b>Item no.: 2002-402/000-006</b><br>Jumper; 2-way; insulated; blue      | <a href="http://www.wago.com/2002-402/000-006">www.wago.com/2002-402/000-006</a> |
|    | <b>Item no.: 2002-405/000-006</b><br>Jumper; 5-way; insulated; blue      | <a href="http://www.wago.com/2002-405/000-006">www.wago.com/2002-405/000-006</a> |
|     | <b>Item no.: 2002-404</b><br>Jumper; 4-way; insulated; light gray        | <a href="http://www.wago.com/2002-404">www.wago.com/2002-404</a>                 |
|    | <b>Item no.: 2002-406/000-006</b><br>Jumper; 6-way; insulated; blue      | <a href="http://www.wago.com/2002-406/000-006">www.wago.com/2002-406/000-006</a> |
|   | <b>Item no.: 2002-406/000-005</b><br>Jumper; 6-way; insulated; red       | <a href="http://www.wago.com/2002-406/000-005">www.wago.com/2002-406/000-005</a> |
|  | <b>Item no.: 2002-406/020-000</b><br>Delta jumper; insulated; light gray | <a href="http://www.wago.com/2002-406/020-000">www.wago.com/2002-406/020-000</a> |
|  | <b>Item no.: 2002-405</b><br>Jumper; 5-way; insulated; light gray        | <a href="http://www.wago.com/2002-405">www.wago.com/2002-405</a>                 |
|  | <b>Item no.: 2002-407/000-005</b><br>Jumper; 7-way; insulated; red       | <a href="http://www.wago.com/2002-407/000-005">www.wago.com/2002-407/000-005</a> |
|  | <b>Item no.: 2002-408</b><br>Jumper; 8-way; insulated; light gray        | <a href="http://www.wago.com/2002-408">www.wago.com/2002-408</a>                 |
|  | <b>Item no.: 2002-408/000-006</b><br>Jumper; 8-way; insulated; blue      | <a href="http://www.wago.com/2002-408/000-006">www.wago.com/2002-408/000-006</a> |



Subject to changes. Please also observe the further product documentation!



Item no.: 2002-405/011-000  
Star point jumper; 3-way; insulated; light gray

[www.wago.com/2002-405/011-000](http://www.wago.com/2002-405/011-000)



Item no.: 2002-407/000-006  
Jumper; 7-way; insulated; blue

[www.wago.com/2002-407/000-006](http://www.wago.com/2002-407/000-006)



Item no.: 2002-408/000-005  
Jumper; 8-way; insulated; red

[www.wago.com/2002-408/000-005](http://www.wago.com/2002-408/000-005)



Item no.: 2002-407  
Jumper; 7-way; insulated; light gray

[www.wago.com/2002-407](http://www.wago.com/2002-407)



Item no.: 2002-406  
Jumper; 6-way; insulated; light gray

[www.wago.com/2002-406](http://www.wago.com/2002-406)



Item no.: 2002-410/000-005  
Jumper; 10-way; insulated; red

[www.wago.com/2002-410/000-005](http://www.wago.com/2002-410/000-005)



Item no.: 2002-410/000-006  
Jumper; 10-way; insulated; blue

[www.wago.com/2002-410/000-006](http://www.wago.com/2002-410/000-006)



Item no.: 2002-410  
Jumper; 10-way; insulated; light gray

[www.wago.com/2002-410](http://www.wago.com/2002-410)



Item no.: 2002-409/000-006  
Jumper; 9-way; insulated; blue

[www.wago.com/2002-409/000-006](http://www.wago.com/2002-409/000-006)



Item no.: 2002-409/000-005  
Jumper; 9-way; insulated; red

[www.wago.com/2002-409/000-005](http://www.wago.com/2002-409/000-005)



Item no.: 2002-409  
Jumper; 9-way; insulated; light gray

[www.wago.com/2002-409](http://www.wago.com/2002-409)



Item no.: 2002-423/000-006  
Continuous jumper; from 1 to 3; insulated; blue

















[www.wago.com/2002-423/000-006](http://www.wago.com/2002-423/000-006)









Item no.: 2002-423  
Continuous jumper; from 1 to 3; insulated; light gray

[www.wago.com/2002-423](http://www.wago.com/2002-423)

Subject to changes. Please also observe the further product documentation!

|  |  |  |
|--|--|--|
|     | <b>Item no.: 2002-433</b><br>Jumper; from 1 to 3; insulated; light gray                          | <a href="http://www.wago.com/2002-433">www.wago.com/2002-433</a>                 |
|     | <b>Item no.: 2002-434</b><br>Jumper; from 1 to 4; insulated; light gray                          | <a href="http://www.wago.com/2002-434">www.wago.com/2002-434</a>                 |
|     | <b>Item no.: 2002-423/000-005</b><br>Continuous jumper; from 1 to 3; insulated; red              | <a href="http://www.wago.com/2002-423/000-005">www.wago.com/2002-423/000-005</a> |
|     | <b>Item no.: 2002-435</b><br>Jumper; from 1 to 5; insulated; light gray                          | <a href="http://www.wago.com/2002-435">www.wago.com/2002-435</a>                 |
|     | <b>Item no.: 2002-436</b><br>Jumper; from 1 to 6; insulated; light gray                          | <a href="http://www.wago.com/2002-436">www.wago.com/2002-436</a>                 |
|     | <b>Item no.: 2002-437</b><br>Jumper; from 1 to 7; insulated; light gray                          | <a href="http://www.wago.com/2002-437">www.wago.com/2002-437</a>                 |
|     | <b>Item no.: 2002-438</b><br>Jumper; from 1 to 8; insulated; light gray                          | <a href="http://www.wago.com/2002-438">www.wago.com/2002-438</a>                 |
|     | <b>Item no.: 2002-439</b><br>Jumper; from 1 to 9; insulated; light gray                          | <a href="http://www.wago.com/2002-439">www.wago.com/2002-439</a>                 |
|     | <b>Item no.: 2002-440</b><br>Jumper; from 1 to 10; insulated; light gray                         | <a href="http://www.wago.com/2002-440">www.wago.com/2002-440</a>                 |
|   | <b>Item no.: 2002-472</b><br>Staggered jumper; 2-way; insulated; light gray                      | <a href="http://www.wago.com/2002-472">www.wago.com/2002-472</a>                 |
|   | <b>Item no.: 2002-473</b><br>Staggered jumper; 3-way; insulated; light gray                      | <a href="http://www.wago.com/2002-473">www.wago.com/2002-473</a>                 |
|  | <b>Item no.: 2002-475/011-000</b><br>Staggered jumper; 3-way; insulated; light gray              | <a href="http://www.wago.com/2002-475/011-000">www.wago.com/2002-475/011-000</a> |
|   | <b>Item no.: 2002-475</b><br>Staggered jumper; 5-way; insulated; light gray                      | <a href="http://www.wago.com/2002-475">www.wago.com/2002-475</a>                 |
|  | <b>Item no.: 2002-476</b><br>Staggered jumper; 6-way; insulated; light gray                      | <a href="http://www.wago.com/2002-476">www.wago.com/2002-476</a>                 |
|   | <b>Item no.: 2002-474</b><br>Staggered jumper; 4-way; insulated; light gray                      | <a href="http://www.wago.com/2002-474">www.wago.com/2002-474</a>                 |
|  | <b>Item no.: 2002-477</b><br>Staggered jumper; 7-way; insulated; light gray                      | <a href="http://www.wago.com/2002-477">www.wago.com/2002-477</a>                 |
|  | <b>Item no.: 2002-473/011-000</b><br>Staggered jumper; 2-way; from 1 to 3; insulated; light gray | <a href="http://www.wago.com/2002-473/011-000">www.wago.com/2002-473/011-000</a> |

Subject to changes. Please also observe the further product documentation!

|   |   |  |
|---|---|--|
|     | <b>Item no.: 2002-479</b><br>Staggered jumper; 9-way; insulated; light gray                           | <a href="http://www.wago.com/2002-479">www.wago.com/2002-479</a>                 |
|     | <b>Item no.: 2002-478</b><br>Staggered jumper; 8-way; insulated; light gray                           | <a href="http://www.wago.com/2002-478">www.wago.com/2002-478</a>                 |
|     | <b>Item no.: 2002-479/011-000</b><br>Staggered jumper; insulated; light gray                          | <a href="http://www.wago.com/2002-479/011-000">www.wago.com/2002-479/011-000</a> |
|     | <b>Item no.: 2002-480</b><br>Staggered jumper; 10-way; insulated; light gray                          | <a href="http://www.wago.com/2002-480">www.wago.com/2002-480</a>                 |
|     | <b>Item no.: 2002-477/011-000</b><br>Staggered jumper; insulated; light gray                          | <a href="http://www.wago.com/2002-477/011-000">www.wago.com/2002-477/011-000</a> |
|     | <b>Item no.: 2002-492</b><br>Vertical jumper; insulated; light gray                                   | <a href="http://www.wago.com/2002-492">www.wago.com/2002-492</a>                 |
|     | <b>Item no.: 2002-481/011-000</b><br>Staggered jumper; insulated; light gray                          | <a href="http://www.wago.com/2002-481/011-000">www.wago.com/2002-481/011-000</a> |
|    | <b>Item no.: 2002-481</b><br>Staggered jumper; 11-way; insulated; light gray                          | <a href="http://www.wago.com/2002-481">www.wago.com/2002-481</a>                 |
|   | <b>Item no.: 2002-492/000-012</b><br>Vertical jumper; insulated; orange                               | <a href="http://www.wago.com/2002-492/000-012">www.wago.com/2002-492/000-012</a> |
|   | <b>Item no.: 2002-482</b><br>Staggered jumper; 12-way; insulated; light gray                          | <a href="http://www.wago.com/2002-482">www.wago.com/2002-482</a>                 |
|   | <b>Item no.: 210-103</b><br>Wire commoning chain; insulated; black                                    | <a href="http://www.wago.com/210-103">www.wago.com/210-103</a>                   |
|  | <b>Item no.: 2002-424/000-006</b><br>Continuous jumper; from 1 to 4; insulated; blue                  | <a href="http://www.wago.com/2002-424/000-006">www.wago.com/2002-424/000-006</a> |
| <b>Insulation stop</b>  |   |  |
| Insulation stop   |   |  |
|   | <b>Item no.: 2002-171</b><br>Insulation stop; 0.25 - 0.5 mm <sup>2</sup> ; 5 pieces/strip; light gray | <a href="http://www.wago.com/2002-171">www.wago.com/2002-171</a>                 |

Subject to changes. Please also observe the further product documentation!



**Item no.: 2002-172**  
Insulation stop; 0.75 - 1 mm<sup>2</sup>; 5 pieces/strip; dark gray

[www.wago.com/2002-172](http://www.wago.com/2002-172)

**Marking accessories**

Marking strip



**Item no.: 2009-110**  
Marking strips; for Smart Printer; on reel; not stretchable; plain; snap-on type; white

[www.wago.com/2009-110](http://www.wago.com/2009-110)

Marker carrier



**Item no.: 2009-198**  
Adaptor; gray

[www.wago.com/2009-198](http://www.wago.com/2009-198)



**Item no.: 2002-121**  
Adaptor; gray

[www.wago.com/2002-121](http://www.wago.com/2002-121)



**Item no.: 2002-161**  
Adaptor; gray

[www.wago.com/2002-161](http://www.wago.com/2002-161)

Marker



**Item no.: 2009-115/000-002**  
WMB-Inline; for Smart Printer; 1500 pieces on roll; stretchable 5 - 5.2 mm; plain; snap-on type; yellow

[www.wago.com/2009-115/000-002](http://www.wago.com/2009-115/000-002)



**Item no.: 2009-115/000-007**  
WMB-Inline; for Smart Printer; 1500 pieces on roll; stretchable 5 - 5.2 mm; plain; snap-on type; gray

[www.wago.com/2009-115/000-007](http://www.wago.com/2009-115/000-007)



**Item no.: 2009-115/000-017**  
WMB-Inline; for Smart Printer; 1500 pieces on roll; stretchable 5 - 5.2 mm; plain; snap-on type; light green

[www.wago.com/2009-115/000-017](http://www.wago.com/2009-115/000-017)



**Item no.: 2009-115/000-023**  
WMB-Inline; for Smart Printer; 1500 pieces on roll; stretchable 5 - 5.2 mm; plain; snap-on type; green

[www.wago.com/2009-115/000-023](http://www.wago.com/2009-115/000-023)



**Item no.: 2009-115/000-024**  
WMB-Inline; for Smart Printer; 1500 pieces on roll; stretchable 5 - 5.2 mm; plain; snap-on type; violet

[www.wago.com/2009-115/000-024](http://www.wago.com/2009-115/000-024)



**Item no.: 2009-145/000-006**  
Mini-WSB Inline; for Smart Printer; 1700 pieces on roll; stretchable 5 - 5.2 mm; plain; snap-on type; blue

[www.wago.com/2009-145/000-006](http://www.wago.com/2009-145/000-006)









**Item no.: 2009-145**  
Mini-WSB Inline; for Smart Printer; 1700 pieces on roll; stretchable 5 - 5.2 mm; plain; snap-on type; white

[www.wago.com/2009-145](http://www.wago.com/2009-145)

**Item no.: 2009-145/000-002**

Subject to changes. Please also observe the further product documentation!

|  |   |  |
|--|---|--|
|    | Mini-WSB Inline; for Smart Printer; 1700 pieces on roll; stretchable 5 - 5.2 mm; plain; snap-on type; yellow                                      | <a href="http://www.wago.com/2009-145/000-002">www.wago.com/2009-145/000-002</a> |
|  | <b>Item no.: 2009-145/000-007</b><br>Mini-WSB Inline; for Smart Printer; 1700 pieces on roll; stretchable 5 - 5.2 mm; plain; snap-on type; gray   | <a href="http://www.wago.com/2009-145/000-007">www.wago.com/2009-145/000-007</a> |
|  | <b>Item no.: 2009-145/000-005</b><br>Mini-WSB Inline; for Smart Printer; 1700 pieces on roll; stretchable 5 - 5.2 mm; plain; snap-on type; red    | <a href="http://www.wago.com/2009-145/000-005">www.wago.com/2009-145/000-005</a> |
|  | <b>Item no.: 2009-145/000-012</b><br>Mini-WSB Inline; for Smart Printer; 1700 pieces on roll; stretchable 5 - 5.2 mm; plain; snap-on type; orange | <a href="http://www.wago.com/2009-145/000-012">www.wago.com/2009-145/000-012</a> |
|  | <b>Item no.: 2009-145/000-023</b><br>Mini-WSB Inline; for Smart Printer; 1700 pieces on roll; stretchable 5 - 5.2 mm; plain; snap-on type; green  | <a href="http://www.wago.com/2009-145/000-023">www.wago.com/2009-145/000-023</a> |
|  | <b>Item no.: 2009-145/000-024</b><br>Mini-WSB Inline; for Smart Printer; 1700 pieces on roll; stretchable 5 - 5.2 mm; plain; snap-on type; violet | <a href="http://www.wago.com/2009-145/000-024">www.wago.com/2009-145/000-024</a> |
|   | <b>Item no.: 2009-115</b><br>WMB-Inline; for Smart Printer; 1500 pieces on roll; stretchable 5 - 5.2 mm; plain; snap-on type; white               | <a href="http://www.wago.com/2009-115">www.wago.com/2009-115</a>                 |
|  | <b>Item no.: 248-501/000-006</b><br>Mini-WSB marking card; as card; not stretchable; plain; snap-on type; blue                                    | <a href="http://www.wago.com/248-501/000-006">www.wago.com/248-501/000-006</a>   |
|  | <b>Item no.: 248-501/000-007</b><br>Mini-WSB marking card; as card; not stretchable; plain; snap-on type; gray                                    | <a href="http://www.wago.com/248-501/000-007">www.wago.com/248-501/000-007</a>   |
|  | <b>Item no.: 248-501/000-002</b><br>Mini-WSB marking card; as card; not stretchable; plain; snap-on type; yellow                                  | <a href="http://www.wago.com/248-501/000-002">www.wago.com/248-501/000-002</a>   |
|  | <b>Item no.: 248-501/000-012</b><br>Mini-WSB marking card; as card; not stretchable; plain; snap-on type; orange                                  | <a href="http://www.wago.com/248-501/000-012">www.wago.com/248-501/000-012</a>   |
|  | <b>Item no.: 248-501</b><br>Mini-WSB marking card; as card; not stretchable; plain; snap-on type; white   | <a href="http://www.wago.com/248-501">www.wago.com/248-501</a>                   |

Subject to changes. Please also observe the further product documentation!



**Item no.:** 248-501/000-017  
Mini-WSB marking card; as card; not stretchable; plain; snap-on type; light green

[www.wago.com/248-501/000-017](http://www.wago.com/248-501/000-017)



**Item no.:** 248-501/000-005  
Mini-WSB marking card; as card; not stretchable; plain; snap-on type; red

[www.wago.com/248-501/000-005](http://www.wago.com/248-501/000-005)

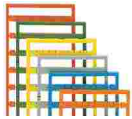

**Item no.:** 248-501/000-024  
Mini-WSB marking card; as card; not stretchable; plain; snap-on type; violet

[www.wago.com/248-501/000-024](http://www.wago.com/248-501/000-024)



**Item no.:** 248-501/000-023  
Mini-WSB marking card; as card; not stretchable; plain; snap-on type; green

[www.wago.com/248-501/000-023](http://www.wago.com/248-501/000-023)



**Item no.:** 793-5501/000-007  
WMB marking card; as card; for terminal block width 5 - 17.5 mm; stretchable 5 - 5.2 mm; plain; snap-on type; gray

[www.wago.com/793-5501/000-007](http://www.wago.com/793-5501/000-007)



**Item no.:** 793-5501/000-012  
WMB marking card; as card; for terminal block width 5 - 17.5 mm; stretchable 5 - 5.2 mm; plain; snap-on type; orange

[www.wago.com/793-5501/000-012](http://www.wago.com/793-5501/000-012)



**Item no.:** 793-5501/000-014  
WMB marking card; as card; for terminal block width 5 - 17.5 mm; stretchable 5 - 5.2 mm; plain; snap-on type; brown

[www.wago.com/793-5501/000-014](http://www.wago.com/793-5501/000-014)



**Item no.:** 793-5501/000-017  
WMB marking card; as card; for terminal block width 5 - 17.5 mm; stretchable 5 - 5.2 mm; plain; snap-on type; light green

[www.wago.com/793-5501/000-017](http://www.wago.com/793-5501/000-017)



**Item no.:** 793-5501/000-023  
WMB marking card; as card; for terminal block width 5 - 17.5 mm; stretchable 5 - 5.2 mm; plain; snap-on type; green

[www.wago.com/793-5501/000-023](http://www.wago.com/793-5501/000-023)



**Item no.:** 793-5501/000-024  
WMB marking card; as card; for terminal block width 5 - 17.5 mm; stretchable 5 - 5.2 mm; plain; snap-on type; violet

[www.wago.com/793-5501/000-024](http://www.wago.com/793-5501/000-024)

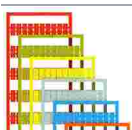

**Item no.:** 793-5501/000-005  
WMB marking card; as card; for terminal block width 5 - 17.5 mm; stretchable 5 - 5.2 mm; plain; snap-on type; red

[www.wago.com/793-5501/000-005](http://www.wago.com/793-5501/000-005)

Subject to changes. Please also observe the further product documentation!

**Item no.:** 793-5501/000-002

WMB marking card; as card; for terminal block width 5 - 17.5 mm; stretchable 5 - 5.2 mm; plain; snap-on type; yellow

[www.wago.com/793-5501/000-002](http://www.wago.com/793-5501/000-002)**Item no.:** 793-5501/000-006

WMB marking card; as card; for terminal block width 5 - 17.5 mm; stretchable 5 - 5.2 mm; plain; snap-on type; blue

[www.wago.com/793-5501/000-006](http://www.wago.com/793-5501/000-006)**Item no.:** 793-5501

WMB marking card; as card; for terminal block width 5 - 17.5 mm; stretchable 5 - 5.2 mm; plain; snap-on type; white

[www.wago.com/793-5501](http://www.wago.com/793-5501)**Item no.:** 2009-115/000-012

WMB-Inline; for Smart Printer; 1500 pieces on roll; stretchable 5 - 5.2 mm; plain; snap-on type; orange

[www.wago.com/2009-115/000-012](http://www.wago.com/2009-115/000-012)**Item no.:** 2009-115/000-006

WMB-Inline; for Smart Printer; 1500 pieces on roll; stretchable 5 - 5.2 mm; plain; snap-on type; blue

[www.wago.com/2009-115/000-006](http://www.wago.com/2009-115/000-006)**Item no.:** 2009-115/000-005

WMB-Inline; for Smart Printer; 1500 pieces on roll; stretchable 5 - 5.2 mm; plain; snap-on type; red

[www.wago.com/2009-115/000-005](http://www.wago.com/2009-115/000-005)**Group marker carrier****Item no.:** 2009-193

Group marker carrier; gray

[www.wago.com/2009-193](http://www.wago.com/2009-193)**Item no.:** 2009-192

Group marker carrier; gray

[www.wago.com/2009-192](http://www.wago.com/2009-192)**Item no.:** 2009-191

Group marker carrier; gray

[www.wago.com/2009-191](http://www.wago.com/2009-191)**Ferrule**

## Ferrule

**Item no.:** 216-241Ferrule; Sleeve for 0.5 mm<sup>2</sup> / 20 AWG; insulated; electro-tin plated; electrolytic copper; gastight crimped; acc. to DIN 46228, Part 4/09.90; white[www.wago.com/216-241](http://www.wago.com/216-241)**Item no.:** 216-242Ferrule; Sleeve for 0.75 mm<sup>2</sup> / 18 AWG; insulated; electro-tin plated; electrolytic copper; gastight crimped; acc. to DIN 46228, Part 4/09.90; gray[www.wago.com/216-242](http://www.wago.com/216-242)**Item no.:** 216-243Ferrule; Sleeve for 1 mm<sup>2</sup> / AWG 18; insulated; electro-tin plated; electrolytic copper; gastight crimped; acc. to DIN 46228, Part 4/09.90; red[www.wago.com/216-243](http://www.wago.com/216-243)**Item no.:** 216-244Ferrule; Sleeve for 1.5 mm<sup>2</sup> / AWG 16; insulated; electro-tin plated; electrolytic copper; gastight crimped; acc. to DIN 46228, Part 4/09.90; black[www.wago.com/216-244](http://www.wago.com/216-244)**Item no.:** 216-263Ferrule; Sleeve for 1 mm<sup>2</sup> / AWG 18; insulated; electro-tin plated; electrolytic copper; gastight crimped;[www.wago.com/216-263](http://www.wago.com/216-263)

Subject to changes. Please also observe the further product documentation!

WAGO GmbH &amp; Co. KG

Hansastr. 27

32423 Minden



Phone: +49571 887-0 | Fax: +49571 887-169

Email: [info.de@wago.com](mailto:info.de@wago.com) | Web: [www.wago.com](http://www.wago.com)

Do you have any questions about our products?

We are always happy to take your call at +49 (571) 887-44222.

acc. to DIN 46228, Part 4/09.90; red

|   |  |  |
|---|--|--|
|  | <b>Item no.: 216-246</b><br>Ferrule; Sleeve for 2.5 mm <sup>2</sup> / AWG 14; insulated; electro-tin plated; electrolytic copper; gastight crimped; acc. to DIN 46228, Part 4/09.90; blue  | <a href="http://www.wago.com/216-246">www.wago.com/216-246</a> |
|  | <b>Item no.: 216-266</b><br>Ferrule; Sleeve for 2.5 mm <sup>2</sup> / AWG 14; insulated; electro-tin plated; electrolytic copper; gastight crimped; acc. to DIN 46228, Part 4/09.90; blue  | <a href="http://www.wago.com/216-266">www.wago.com/216-266</a> |
|  | <b>Item no.: 216-264</b><br>Ferrule; Sleeve for 1.5 mm <sup>2</sup> / AWG 16; insulated; electro-tin plated; electrolytic copper; gastight crimped; acc. to DIN 46228, Part 4/09.90; black | <a href="http://www.wago.com/216-264">www.wago.com/216-264</a> |
|  | <b>Item no.: 216-262</b><br>Ferrule; Sleeve for 0.75 mm <sup>2</sup> / 18 AWG; insulated; electro-tin plated; electrolytic copper; gastight crimped; acc. to DIN 46228, Part 4/09.90; gray | <a href="http://www.wago.com/216-262">www.wago.com/216-262</a> |





**Protective warning marker**

Cover

|  |  |  |
|--|--|--|
|  | <b>Item no.: 2002-115</b><br>Protective warning marker; for 5 terminal blocks; with high-voltage symbol, black; yellow | <a href="http://www.wago.com/2002-115">www.wago.com/2002-115</a> |
|--|--|--|



**Push-in type wire jumper**

Jumper

|  |  |  |
|--|--|--|
|   | <b>Item no.: 2009-412</b><br>Push-in type wire jumper; insulated; 60 mm long; black                                | <a href="http://www.wago.com/2009-412">www.wago.com/2009-412</a>                 |
|  | <b>Item no.: 2009-414</b><br>Push-in type wire jumper; 1.5 mm <sup>2</sup> ; insulated; 110 mm long; black         | <a href="http://www.wago.com/2009-414">www.wago.com/2009-414</a>                 |
|  | <b>Item no.: 2009-416</b><br>Push-in type wire jumper; 1.5 mm <sup>2</sup> ; insulated; 250 mm long; black         | <a href="http://www.wago.com/2009-416">www.wago.com/2009-416</a>                 |
|  | <b>Item no.: 2009-414/000-005</b><br>Push-in type wire jumper; 1.5 mm <sup>2</sup> ; insulated; 110 mm long; black | <a href="http://www.wago.com/2009-414/000-005">www.wago.com/2009-414/000-005</a> |
|  | <b>Item no.: 2009-414/000-006</b><br>Push-in type wire jumper; insulated; 110 mm long; black                       | <a href="http://www.wago.com/2009-414/000-006">www.wago.com/2009-414/000-006</a> |

**Testing and measuring**

Testing accessories

|  |   |  |
|--|---|--|
|   | <b>Item no.: 2009-174</b><br>Test plug adapter; for 4 mm Ø test plugs; for testing TOPJOB®S rail-mounted terminal blocks; gray              | <a href="http://www.wago.com/2009-174">www.wago.com/2009-174</a> |
|  | <b>Item no.: 2009-182</b><br>Testing tap; for max. 2.5 mm <sup>2</sup> ; tool-free connection for individual test wires 0.08 - 2.5 mm; gray | <a href="http://www.wago.com/2009-182">www.wago.com/2009-182</a> |
|   | <b>Item no.: 2002-611</b>   | <a href="http://www.wago.com/2002-611">www.wago.com/2002-611</a> |

Subject to changes. Please also observe the further product documentation!





TOPJOB®S L-type test plug module; modular; 1-pole; 2,50 mm<sup>2</sup>; gray

|   |  |  |
|---|--|--|
|  | <b>Item no.: 2002-649</b><br>TOPJOB®S L-type spacer module; modular; e.g., for bridging commoned terminal blocks; gray | <a href="http://www.wago.com/2002-649">www.wago.com/2002-649</a> |
|---|--|--|

**Tool**

Operating tool

|  |   |  |
|--|---|--|
|  | <b>Item no.: 210-658</b><br>Operating tool; Blade: 3.5 x 0.5 mm; with a partially insulated shaft; angled; short; multicoloured | <a href="http://www.wago.com/210-658">www.wago.com/210-658</a> |
|--|---|--|

|  |  |  |
|--|--|--|
|  | <b>Item no.: 210-720</b><br>Operating tool; Blade: 3.5 x 0.5 mm; with a partially insulated shaft; multicoloured | <a href="http://www.wago.com/210-720">www.wago.com/210-720</a> |
|--|--|--|

**Downloads**

**Documentation**

**Bid Text**

|                           |             |                 |          |
|---------------------------|-------------|-----------------|----------|
| 2002-2602<br>docx - Datei | 2019 Apr 18 | docx<br>15.4 kB | Download |
| 2002-2602<br>X81 - Datei  | 2019 Apr 18 | xml<br>4.2 kB   | Download |

**Additional Information**

|   |  |               |          |
|---|--|---------------|----------|
| Technical Section<br>Technical explanations |  | pdf<br>2.2 MB | Download |
|---|--|---------------|----------|

**CAD/CAE-Data**

**CAD data**

|                        |  |     |          |
|------------------------|--|-----|----------|
| 2D/3D Models 2002-2602 |  | URL | Download |
|------------------------|--|-----|----------|

**CAE data**

|                             |  |     |          |
|-----------------------------|--|-----|----------|
| WSCAD Universe 2002-2602    |  | URL | Download |
| ZUKEN Portal 2002-2602      |  | URL | Download |
| EPLAN Data Portal 2002-2602 |  | URL | Download |

Subject to changes. Please also observe the further product documentation!

WAGO GmbH & Co. KG  
Hansastr. 27  
32423 Minden  
Phone: +49571 887-0 | Fax: +49571 887-169  
Email: [info.de@wago.com](mailto:info.de@wago.com) | Web: [www.wago.com](http://www.wago.com)

Do you have any questions about our products?  
We are always happy to take your call at +49 (571) 887-44222.

## Environmental Product Compliance

### Compliance Search

Environmental Product Compliance 2002-2602

[URL](#)

[Download](#)

Double-deck terminal block; Through/through terminal block; same profile as double-deck disconnect terminal block; N/L; without marker carrier; Blue conductor entry lower deck; for DIN-rail 35 x 15 and 35 x 7.5; 2.5 mm<sup>2</sup>; Push-in CAGE CLAMP®; 2,50 mm<sup>2</sup>; gray

## Installation Notes

### Commoning

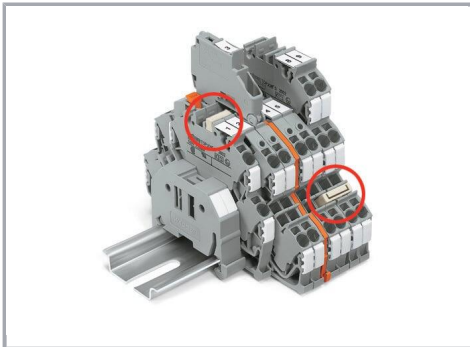

The same profile allows for commoning with TOPJOB® S double-deck terminal blocks (upper deck) and with triple-deck terminal blocks (lower deck).

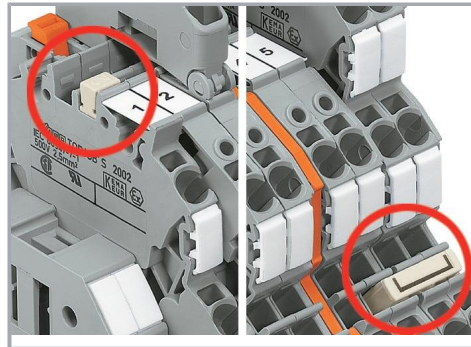

Left picture – Vertical jumper (2002-492)

Right picture – Push-in type jumper bar (2002 Series)

## Product family

### TOPJOB® S

TOPJOB® S: In various industrial applications and modern building installations, WAGO's wide and versatile range of rail-mount terminal blocks provides more than just reliable electrical connections.

[Show all products from the family](#)

Subject to changes. Please also observe the further product documentation!