

## 0.5dB LSB GaAs MMIC 6-BIT DIGITAL ATTENUATOR, DC - 13 GHz

### Typical Applications

The HMC424 is ideal for:

- Fiber Optics & Broadband Telecom
- Microwave Radio & VSAT
- Military Radios, Radar & ECM
- Space Applications

### Features

- 0.5 dB LSB Steps to 31.5 dB
- Single Control Line Per Bit
- ±0.5 dB Typical Bit Error
- Die Size: 1.45 x 0.85 x 0.1 mm

### Functional Diagram

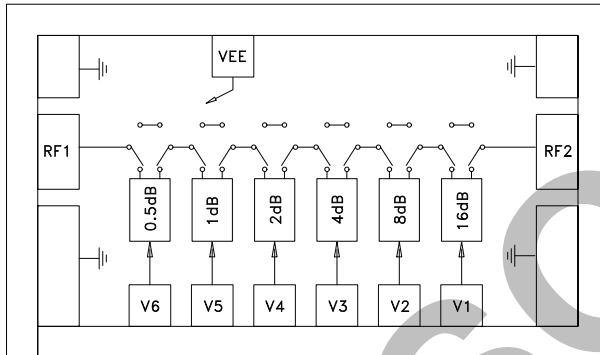

### General Description

The HMC424 die is a broadband 6-bit GaAs IC digital attenuator MMIC chip. Covering DC to 13 GHz, the insertion loss is less than 4 dB typical. The attenuator bit values are 0.5 (LSB), 1, 2, 4, 8, and 16 dB for a total attenuation of 31.5 dB. Attenuation accuracy is excellent at ± 0.5 dB typical step error with an IIP3 of +32 dBm. Six control voltage inputs, toggled between 0 and -5V, are used to select each attenuation state. A single Vee bias of -5V allows operation at frequencies down to DC.

### Electrical Specifications, $T_A = +25^\circ\text{C}$ , With Vee = -5V & VCTL = 0/-5V

| Parameter  | Frequency (GHz)     | Min.                             | Typ. | Max. | Units |
|--|---------------------|----------------------------------|------|------|-------|
| Insertion Loss   | DC - 8.0 GHz        |                                  | 3.0  | 3.8  | dB    |
|  | 8.0 - 13.0 GHz      |                                  | 4.0  | 4.6  | dB    |
| Attenuation Range  | DC - 13.0 GHz       |                                  | 31.5 |      | dB    |
| Return Loss (RF1 & RF2, All Atten. States)                                   | DC - 8.0 GHz        | 8                                | 12   |      | dB    |
|  | 8.0 - 13.0 GHz      | 11                               | 15   |      | dB    |
| Attenuation Accuracy: (Referenced to Insertion Loss)                         | 0.5 - 7.5 dB States | ± 0.3 + 4% of Atten. Setting Max |      |      | dB    |
|  | 8 - 31.5 dB States  | ± 0.3 + 6% of Atten. Setting Max |      |      | dB    |
| Input Power for 0.1 dB Compression   | 1.0 - 13.0 GHz      |                                  | 22   |      | dBm   |
| Input Third Order Intercept Point<br>(Two-Tone Input Power= 0 dBm Each Tone) | 1.0 - 13.0 GHz      | REF State                        | 46   |      | dBm   |
|  |                     | All Other States                 | 32   |      | dBm   |
| Switching Characteristics  | DC - 13.0 GHz       | tRISE, tFALL (10/90% RF)         | 30   |      | ns    |
|  |                     | tON/tOFF (50% CTL to 10/90% RF)  | 50   |      | ns    |

Information furnished by Analog Devices is believed to be accurate and reliable. However, no responsibility is assumed by Analog Devices for its use, nor for any infringements of patents or other rights of third parties that may result from its use. Specifications subject to change without notice. No license is granted by implication or otherwise under any patent or patent rights of Analog Devices. Trademarks and registered trademarks are the property of their respective owners.

For price, delivery, and to place orders: Analog Devices, Inc., One Technology Way, P.O. Box 9106, Norwood, MA 02062-9106  
Phone: 781-329-4700 • Order online at [www.analog.com](http://www.analog.com)  
Application Support: Phone: 1-800-ANALOG-D

**0.5dB LSB GaAs MMIC 6-BIT DIGITAL  
ATTENUATOR, DC - 13 GHz**

**Insertion Loss**

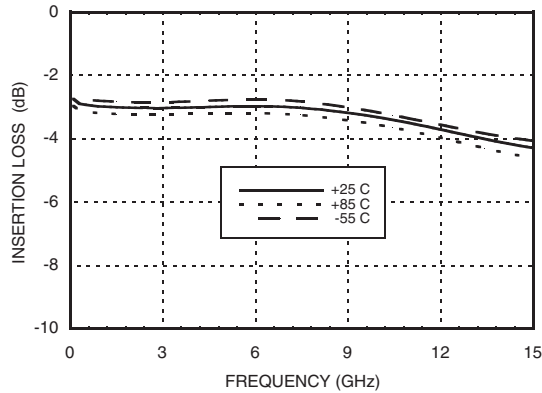

**Return Loss RF1, RF2  
(Only Major States are Shown)**

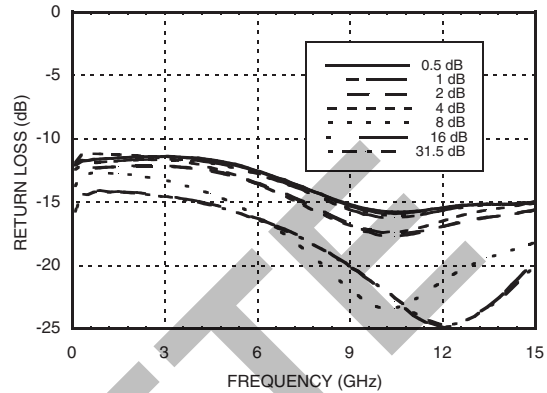

**Normalized Attenuation  
(Only Major States are Shown)**

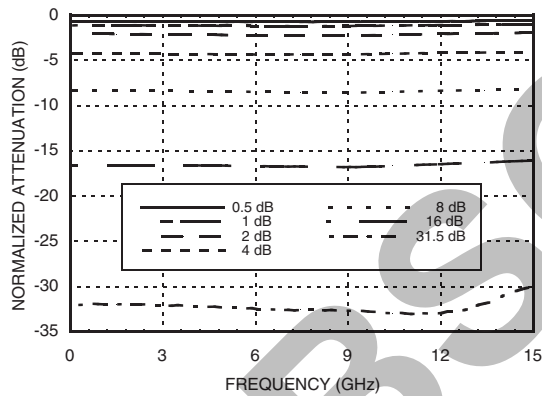

**Bit Error vs. Attenuation State**

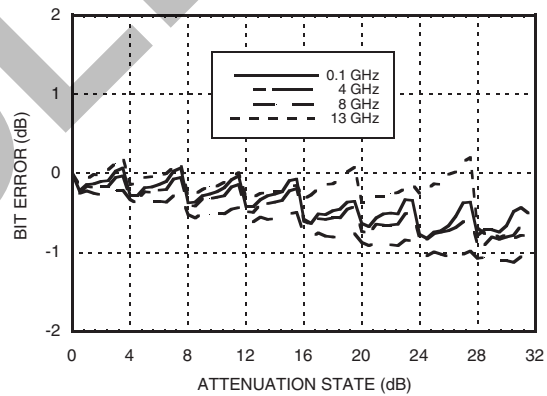

**Bit Error vs. Frequency  
(Only Major States are Shown)**

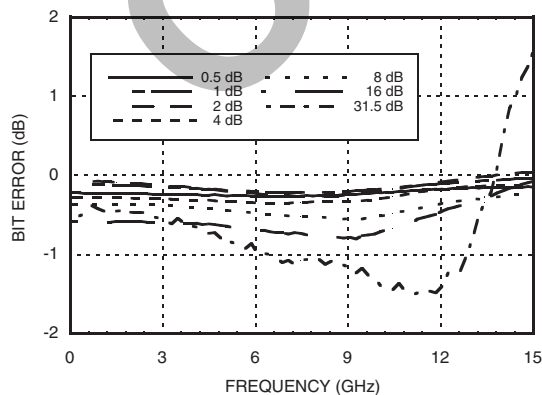

**Relative Phase vs. Frequency  
(Only Major States are Shown)**

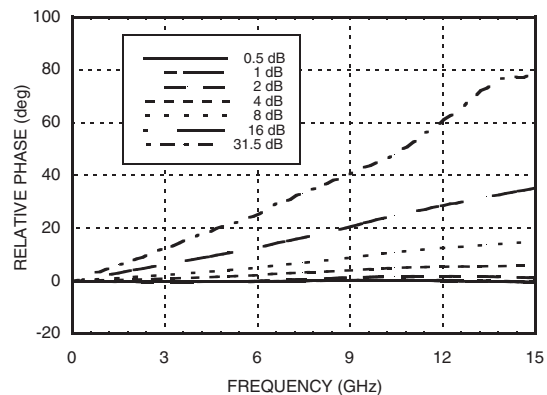

Information furnished by Analog Devices is believed to be accurate and reliable. However, no responsibility is assumed by Analog Devices for its use, nor for any infringements of patents or other rights of third parties that may result from its use. Specifications subject to change without notice. No license is granted by implication or otherwise under any patent or patent rights of Analog Devices. Trademarks and registered trademarks are the property of their respective owners.

For price, delivery, and to place orders: Analog Devices, Inc., One Technology Way, P.O. Box 9106, Norwood, MA 02062-9106 Phone: 781-329-4700 • Order online at [www.analog.com](http://www.analog.com) Application Support: Phone: 1-800-ANALOG-D

## 0.5dB LSB GaAs MMIC 6-BIT DIGITAL ATTENUATOR, DC - 13 GHz

### Worst Case Step Error Between Successive Attenuation States

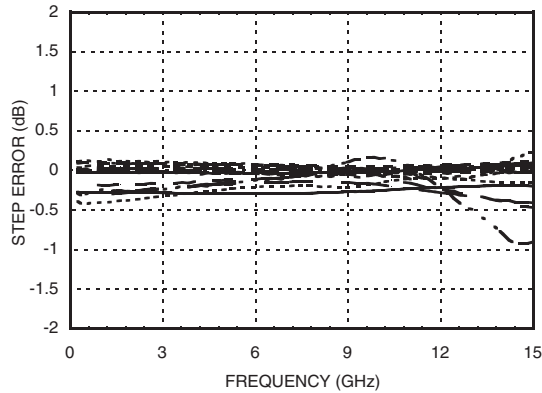

### Bias Voltage & Current

| Vee Range= -5 Vdc ± 10% |                 |                 |
|-------------------------|-----------------|-----------------|
| Vee (Vdc)               | Iee (Typ.) (mA) | Iee (Max.) (mA) |
| -5                      | 2               | 5               |

### Control Voltage

| State | Bias Condition               |
|-------|------------------------------|
| Low   | 0 to -3V @ 35 µA Typ.        |
| High  | Vee to Vee +0.8V @ 5 µA Typ. |

### Truth Table

| Control Voltage Input |            |            |            |            |              | Attenuation State<br>RF1 - RF2 |
|-----------------------|------------|------------|------------|------------|--------------|--------------------------------|
| V1<br>16 dB           | V2<br>8 dB | V3<br>4 dB | V4<br>2 dB | V5<br>1 dB | V6<br>0.5 dB |                                |
| Low                   | Low        | Low        | Low        | Low        | Low          | Reference I.L.                 |
| Low                   | Low        | Low        | Low        | Low        | High         | 0.5 dB                         |
| Low                   | Low        | Low        | Low        | High       | Low          | 1 dB                           |
| Low                   | Low        | Low        | High       | Low        | Low          | 2 dB                           |
| Low                   | Low        | High       | Low        | Low        | Low          | 4 dB                           |
| Low                   | High       | Low        | Low        | Low        | Low          | 8 dB                           |
| High                  | Low        | Low        | Low        | Low        | Low          | 16 dB                          |
| High                  | High       | High       | High       | High       | High         | 31.5 dB                        |

Any Combination of the above states will provide an attenuation approximately equal to the sum of the bits selected.

### Absolute Maximum Ratings

|                               |                 |
|-------------------------------|-----------------|
| Control Voltage (V1 to V6)    | Vee - 0.5 Vdc   |
| Bias Voltage (Vee)            | -7 Vdc          |
| Channel Temperature           | 150 °C          |
| Thermal Resistance            | 330 °C/W        |
| Storage Temperature           | -65 to + 150 °C |
| Operating Temperature         | -55 to +85 °C   |
| RF Input Power (0.5 - 13 GHz) | +25 dBm         |



ELECTROSTATIC SENSITIVE DEVICE  
OBSERVE HANDLING PRECAUTIONS

### Die Packaging Information [1]

| Standard           | Alternate |
|--------------------|-----------|
| WP-8 (Waffle Pack) | [2]       |

[1] Refer to the "Packaging Information" section for die packaging dimensions.

[2] For alternate packaging information contact Hittite Microwave Corporation.

**0.5dB LSB GaAs MMIC 6-BIT DIGITAL  
ATTENUATOR, DC - 13 GHz**

**Outline Drawing**

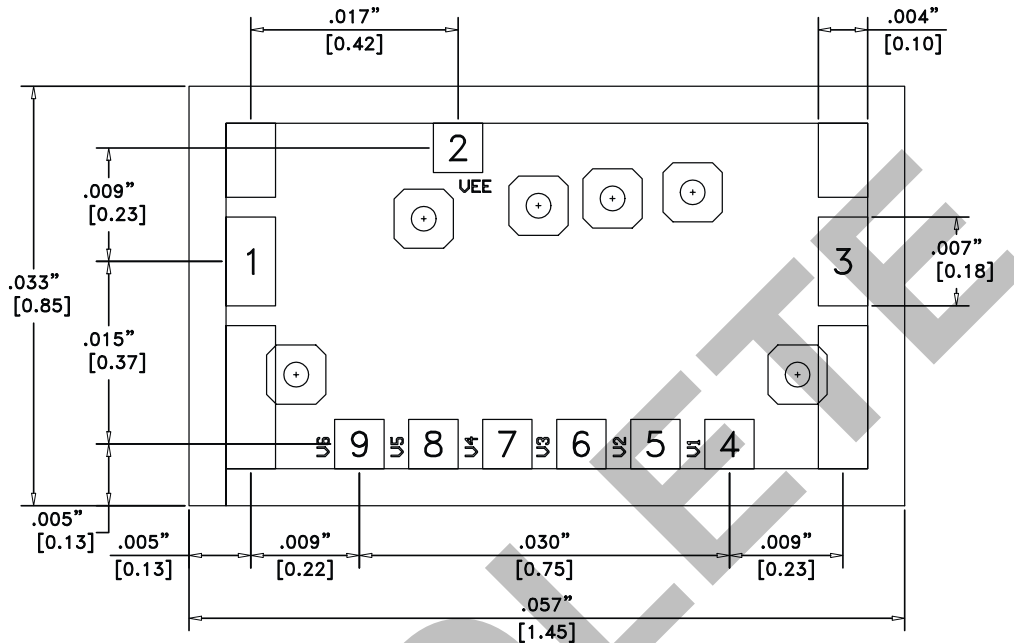

1. ALL DIMENSIONS ARE IN INCHES (MILLIMETERS).
2. TYPICAL BOND PAD IS .004" SQUARE.
3. TYPICAL BOND PAD SPACING IS .006" CENTER TO CENTER EXCEPT AS NOTED.
4. BACKSIDE METALIZATION: GOLD
5. BACKSIDE METAL IS GROUND
6. BOND PAD METALIZATION: GOLD

**Pad Descriptions**

| Pad Number       | Function | Description   | Interface Schematic |
|------------------|----------|---|---------------------|
|                  | GND      | Die bottom must be connected to RF ground.  |                     |
| 1, 3             | RF1, RF2 | This pad is DC coupled and matched to 50 Ohm. Blocking capacitors are required if RF line potential is not equal to 0V. |                     |
| 2                | VEE      | Supply Voltage -5V ± 10%  |                     |
| 4, 5, 6, 7, 8, 9 | V1 - V6  | See truth table and control voltage table.  |                     |

Information furnished by Analog Devices is believed to be accurate and reliable. However, no responsibility is assumed by Analog Devices for its use, nor for any infringements of patents or other rights of third parties that may result from its use. Specifications subject to change without notice. No license is granted by implication or otherwise under any patent or patent rights of Analog Devices. Trademarks and registered trademarks are the property of their respective owners.

For price, delivery, and to place orders: Analog Devices, Inc., One Technology Way, P.O. Box 9106, Norwood, MA 02062-9106 Phone: 781-329-4700 • Order online at [www.analog.com](http://www.analog.com) Application Support: Phone: 1-800-ANALOG-D

**0.5dB LSB GaAs MMIC 6-BIT DIGITAL ATTENUATOR, DC - 13 GHz**

**Suggested Driver Circuit** (One Circuit Required Per Bit Control Input)

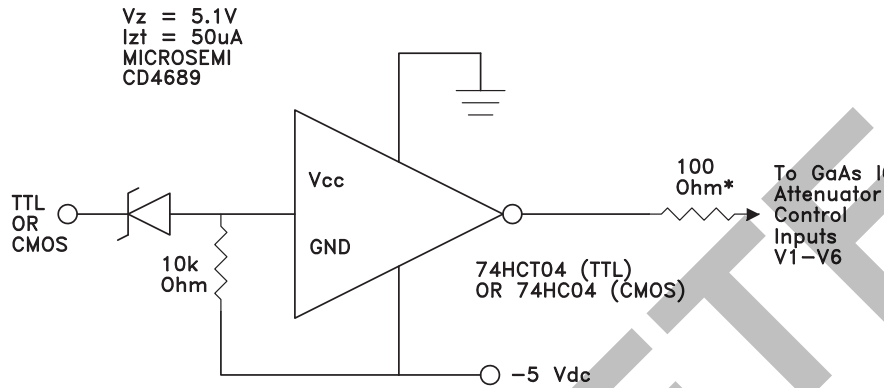

Simple driver using inexpensive standard logic ICs provides fast switching using minimum DC current.  
\* Recommended value to suppress unwanted RF signals at V1 - V6 control lines.

**Assembly Diagram**

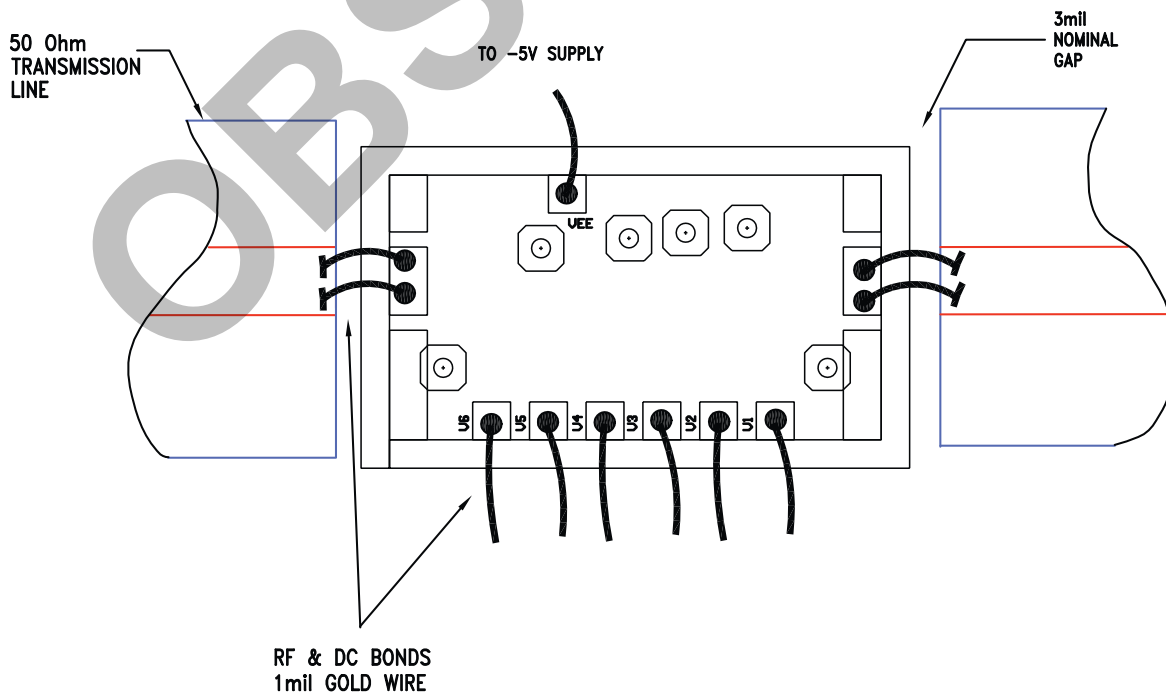

Information furnished by Analog Devices is believed to be accurate and reliable. However, no responsibility is assumed by Analog Devices for its use, nor for any infringements of patents or other rights of third parties that may result from its use. Specifications subject to change without notice. No license is granted by implication or otherwise under any patent or patent rights of Analog Devices. Trademarks and registered trademarks are the property of their respective owners.

For price, delivery, and to place orders: Analog Devices, Inc., One Technology Way, P.O. Box 9106, Norwood, MA 02062-9106  
Phone: 781-329-4700 • Order online at [www.analog.com](http://www.analog.com)  
Application Support: Phone: 1-800-ANALOG-D

## 0.5dB LSB GaAs MMIC 6-BIT DIGITAL ATTENUATOR, DC - 13 GHz

### Mounting & Bonding Techniques for Millimeterwave GaAs MMICs

The die should be attached directly to the ground plane eutectically or with conductive epoxy (see HMC general Handling, Mounting, Bonding Note).

50 Ohm Microstrip transmission lines on 0.127mm (5 mil) thick alumina thin film substrates are recommended for bringing RF to and from the chip (Figure 1). If 0.254mm (10 mil) thick alumina thin film substrates must be used, the die should be raised 0.150mm (6 mils) so that the surface of the die is coplanar with the surface of the substrate. One way to accomplish this is to attach the 0.102mm (4 mil) thick die to a 0.150mm (6 mil) thick molybdenum heat spreader (moly-tab) which is then attached to the ground plane (Figure 2).

Microstrip substrates should be brought as close to the die as possible in order to minimize bond wire length. Typical die-to-substrate spacing is 0.076mm to 0.152 mm (3 to 6 mils).

#### Handling Precautions

Follow these precautions to avoid permanent damage.

**Storage:** All bare die are placed in either Waffle or Gel based ESD protective containers, and then sealed in an ESD protective bag for shipment. Once the sealed ESD protective bag has been opened, all die should be stored in a dry nitrogen environment.

**Cleanliness:** Handle the chips in a clean environment. DO NOT attempt to clean the chip using liquid cleaning systems.

**Static Sensitivity:** Follow ESD precautions to protect against ESD strikes.

**Transients:** Suppress instrument and bias supply transients while bias is applied. Use shielded signal and bias cables to minimize inductive pick-up.

**General Handling:** Handle the chip along the edges with a vacuum collet or with a sharp pair of bent tweezers. The surface of the chip has fragile air bridges and should not be touched with vacuum collet, tweezers, or fingers.

#### Mounting

The chip is back-metallized and can be die mounted with AuSn eutectic preforms or with electrically conductive epoxy. The mounting surface should be clean and flat.

**Eutectic Die Attach:** A 80/20 gold tin preform is recommended with a work surface temperature of 255 °C and a tool temperature of 265 °C. When hot 90/10 nitrogen/hydrogen gas is applied, tool tip temperature should be 290 °C. DO NOT expose the chip to a temperature greater than 320 °C for more than 20 seconds. No more than 3 seconds of scrubbing should be required for attachment.

**Epoxy Die Attach:** Apply a minimum amount of epoxy to the mounting surface so that a thin epoxy fillet is observed around the perimeter of the chip once it is placed into position. Cure epoxy per the manufacturer's schedule.

#### Wire Bonding

Ball or wedge bond with 0.025mm (1 mil) diameter pure gold wire. Thermosonic wirebonding with a nominal stage temperature of 150 °C and a ball bonding force of 40 to 50 grams or wedge bonding force of 18 to 22 grams is recommended. Use the minimum level of ultrasonic energy to achieve reliable wirebonds. Wirebonds should be started on the chip and terminated on the package or substrate. All bonds should be as short as possible <0.31mm (12 mils).

