

# Single relay - REL-IR4/LDP- 48DC/4X21 - 2903678

Please be informed that the data shown in this PDF Document is generated from our Online Catalog. Please find the complete data in the user's documentation. Our General Terms of Use for Downloads are valid (<http://phoenixcontact.com/download>)



Plug-in industrial relay with power contacts, 4 PDTs, test key, status LED, freewheeling diode, mechanical switch position indicator, polarity: A1+, A2-, coil voltage: 48 V DC



## Key Commercial Data

Packing unit	10 pc
Minimum order quantity	10 pc
GTIN	 4 046356 758918
GTIN	4046356758918

## Technical data

### Dimensions

Width	21.2 mm
Height	27.5 mm
Depth	35.6 mm

### Ambient conditions

Ambient temperature (operation)	-40 °C ... 70 °C
Ambient temperature (storage/transport)	-40 °C ... 85 °C
Degree of protection	RT I

### Coil side

Nominal input voltage $U_N$	48 V DC
Input voltage range in reference to $U_N$	see diagram
Typical input current at $U_N$	22 mA
Typical response time	13 ms
Typical release time	14 ms
Protective circuit	Damping diode
Status display	Yellow LED

# Single relay - REL-IR4/LDP- 48DC/4X21 - 2903678

## Technical data

### Coil side

Power dissipation for nominal condition	1.06 W
-----------------------------------------	--------

### Contact side

Contact type	4 PDTs
Type of switch contact	Single contact
Contact material	AgNi
Maximum switching voltage	250 V AC/DC
Minimum switching voltage	5 V (At 24 mA)
Min. switching current	5 mA (at 24 V)
Maximum inrush current	16 A (20 ms, N/O contact)
Limiting continuous current	6 A
Interrupting rating (ohmic load) max.	144 W (at 24 V DC)
	124 W (at 48 V DC)
	108 W (at 60 V DC)
	52 W (at 110 V DC)
	48 W (at 220 V DC)
	1500 VA (for 250 V AC)
Switching capacity min.	0.12 W
Switching capacity	2 A (at 24 V, DC13)
	0.22 A (at 120 V, DC13)
	0.11 A (at 250 V, DC13)
	1.5 A (at 24 V, AC15)
	1.5 A (at 120 V, AC15)
	1 A (at 240 V, AC15)
Motor load according to UL 508	1/3 HP, 240 V AC

### General

Test voltage relay winding/relay contact	2.5 kV <sub>rms</sub> (50 Hz, 1 min.)
Test voltage PDT/PDT	2 kV <sub>rms</sub> (50 Hz, 1 min.)
Operating mode	100% operating factor
Mechanical service life	approx. 2x 10 <sup>7</sup> cycles
Service life, electrical	see diagram
Mounting position	any

### Connection data

Connection method	Plug connection
-------------------	-----------------

### Standards and Regulations

Connection in acc. with standard	CSA
Standards/regulations	IEC 60664
	IEC 61810
Rated insulation voltage	250 V AC
Rated surge voltage	2.5 kV

# Single relay - REL-IR4/LDP- 48DC/4X21 - 2903678

## Technical data

### Standards and Regulations

Insulation	Basic insulation
Pollution degree	2
Overvoltage category	II

### Environmental Product Compliance

China RoHS	Environmentally Friendly Use Period = 50
	For details about hazardous substances go to tab "Downloads", Category "Manufacturer's declaration"

## Drawings

Diagram

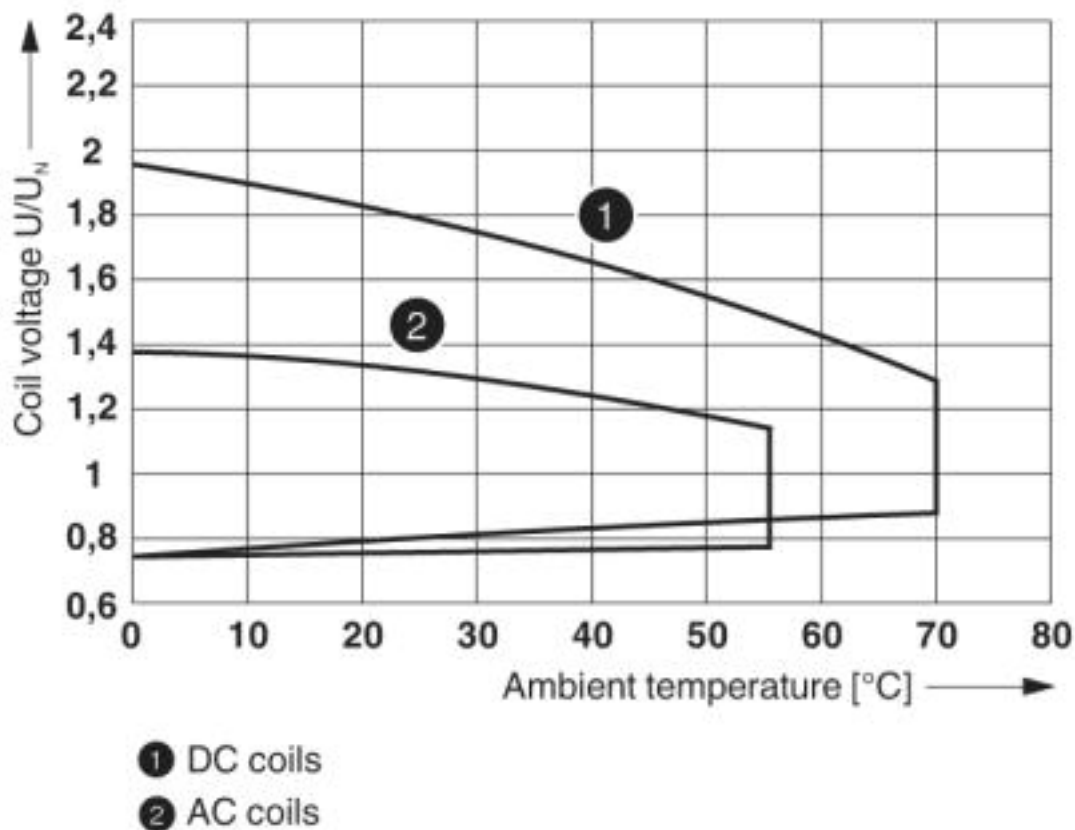

Operating voltage range

# Single relay - REL-IR4/LDP- 48DC/4X21 - 2903678

Diagram

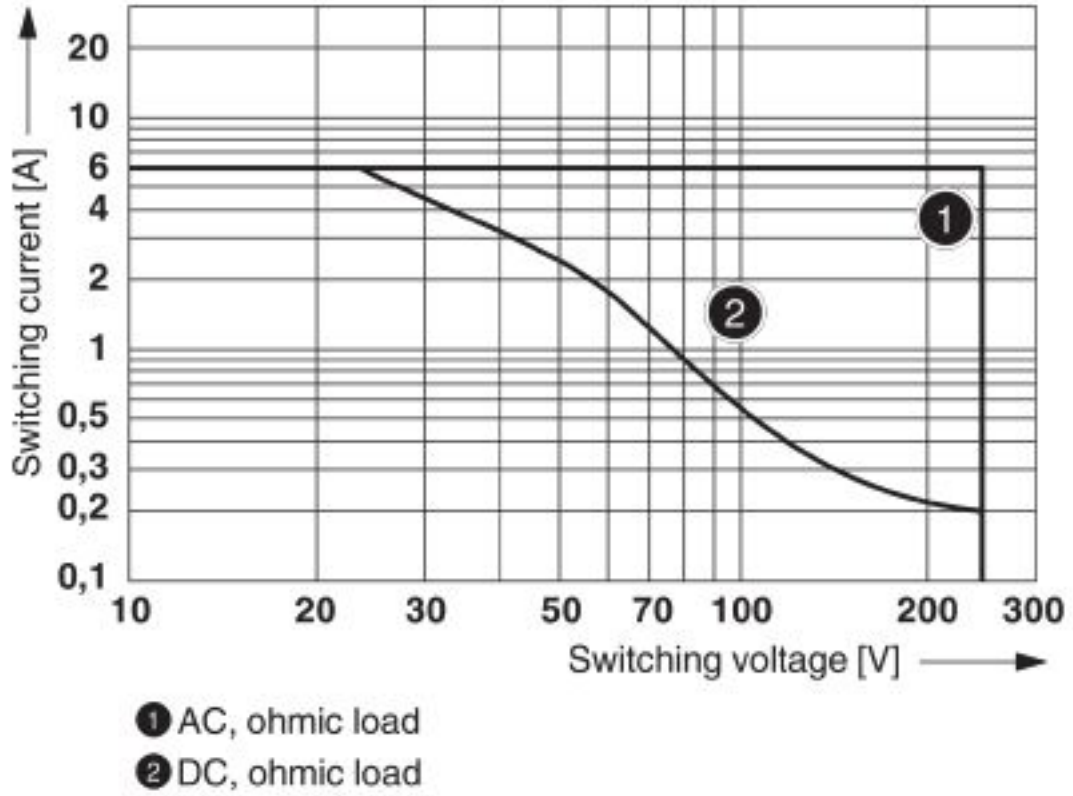

Interrupting rating

# Single relay - REL-IR4/LDP- 48DC/4X21 - 2903678

Diagram

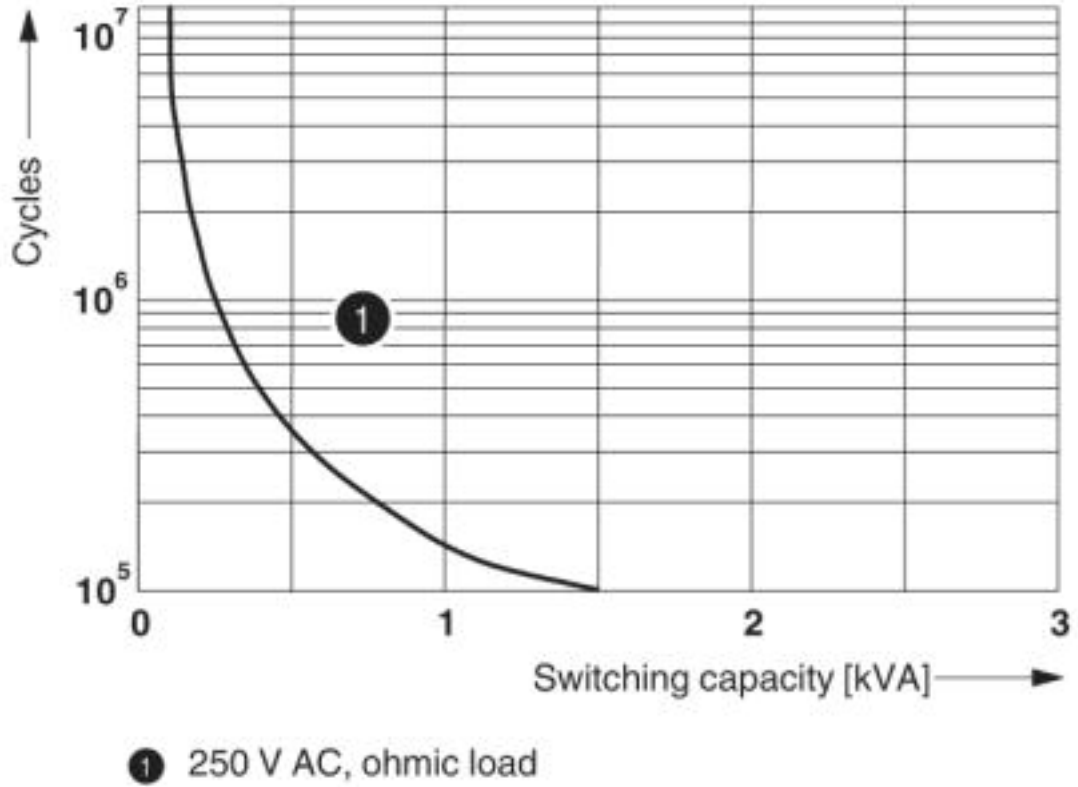

Electrical service life

# Single relay - REL-IR4/LDP- 48DC/4X21 - 2903678

Diagram

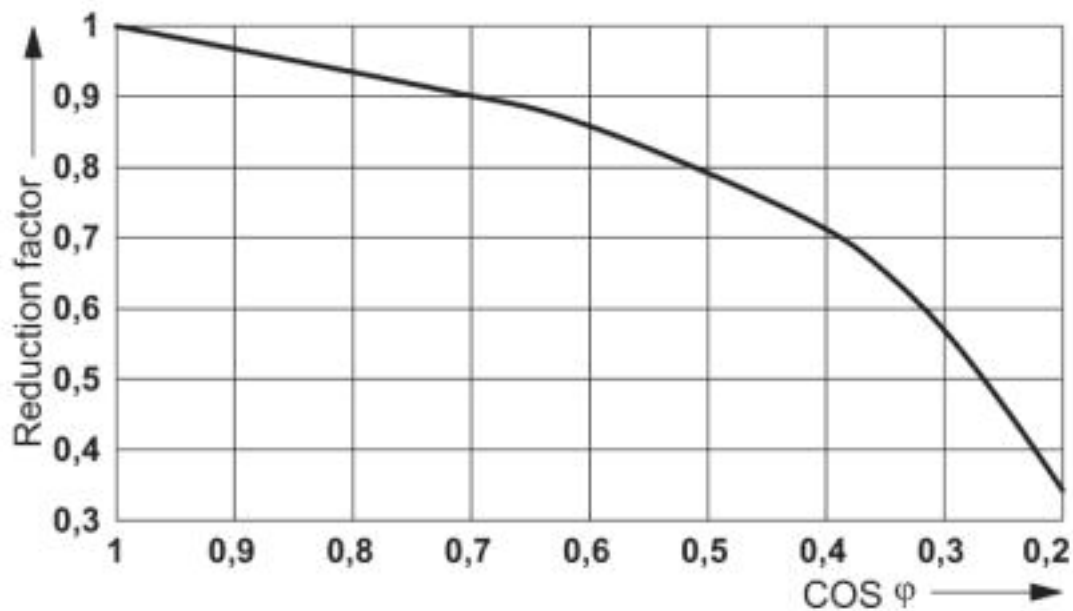

Service life reduction factor

Circuit diagram

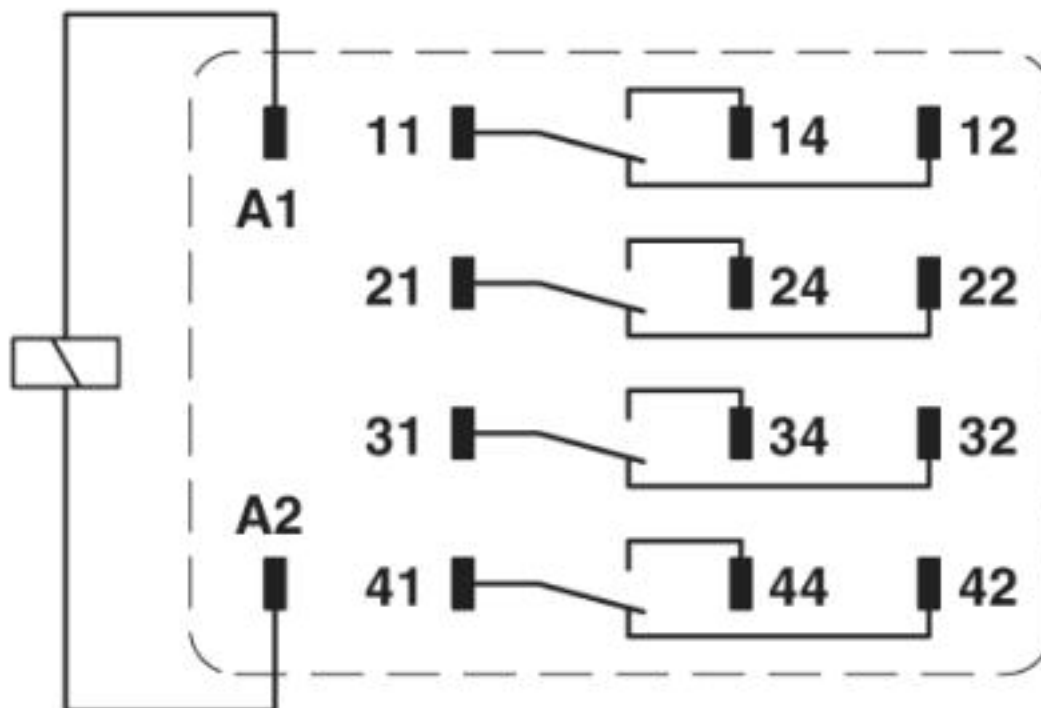

# Single relay - REL-IR4/LDP- 48DC/4X21 - 2903678

## Approvals

### Approvals

---

#### Approvals

CSA / UL Recognized / cUL Recognized / VDE Zeichengenehmigung / EAC / cULus Recognized

---

#### Ex Approvals

---

### Approval details

CSA		<a href="http://www.csagroup.org/services-industries/product-listing/">http://www.csagroup.org/services-industries/product-listing/</a>	2554095
-----	-----------------------------------------------------------------------------------	-----------------------------------------------------------------------------------------------------------------------------------------	---------

UL Recognized		<a href="http://database.ul.com/cgi-bin/XYV/template/LISEXT/1FRAME/index.htm">http://database.ul.com/cgi-bin/XYV/template/LISEXT/1FRAME/index.htm</a>	FILE E 172140
---------------	------------------------------------------------------------------------------------	-------------------------------------------------------------------------------------------------------------------------------------------------------	---------------

cUL Recognized		<a href="http://database.ul.com/cgi-bin/XYV/template/LISEXT/1FRAME/index.htm">http://database.ul.com/cgi-bin/XYV/template/LISEXT/1FRAME/index.htm</a>	FILE E 172140
----------------	-------------------------------------------------------------------------------------	-------------------------------------------------------------------------------------------------------------------------------------------------------	---------------

VDE Zeichengenehmigung		<a href="http://www2.vde.com/de/Institut/Online-Service/VDE-gepruefteProdukte/Seiten/Online-Suche.aspx">http://www2.vde.com/de/Institut/Online-Service/VDE-gepruefteProdukte/Seiten/Online-Suche.aspx</a>	40040427
------------------------	-------------------------------------------------------------------------------------	-----------------------------------------------------------------------------------------------------------------------------------------------------------------------------------------------------------	----------

EAC			TR_TS_D_00573_c
-----	-------------------------------------------------------------------------------------	--	-----------------

cULus Recognized			
------------------	-------------------------------------------------------------------------------------	--	--

---

Phoenix Contact 2019 © - all rights reserved  
<http://www.phoenixcontact.com>

PHOENIX CONTACT GmbH & Co. KG  
Flachsmarktstr. 8  
32825 Blomberg  
Germany  
Tel. +49 5235 300  
Fax +49 5235 3 41200  
<http://www.phoenixcontact.com>