

Sensor/actuator cable - SAC-8P-M12MS/ 2,0-28X SH OD - 1407279

Please be informed that the data shown in this PDF Document is generated from our Online Catalog. Please find the complete data in the user's documentation. Our General Terms of Use for Downloads are valid (<http://phoenixcontact.com/download>)



Sensor/actuator cable, 8-position, PE-X/PE-X halogen-free, black-gray RAL 7021, shielded, Plug straight M12, A-coded, on free cable end, cable length: 2 m, for outdoor applications, with high-grade steel knurl

Your advantages

- ✓ Easy and safe: 100% electrically tested plug-in components
- ✓ Corrosion protection for all exposed metal parts, thanks to the use of stainless steel type 1.4404
- ✓ Robust throughout: resistant to oil, UV, and ozone, withstands temperatures from -40°C to +105°C
- ✓ Reliable signal transmission – 360° shielding in environments with electromagnetic interference

Key Commercial Data

Packing unit	1 pc
GTIN	
GTIN	4046356773973

Technical data

Dimensions

Length of cable	2 m
-----------------	-----

Ambient conditions

Ambient temperature (operation)	-40 °C ... 105 °C (Plug / socket)
	-40 °C ... 85 °C (On sudden changes in temperature (according to IEC 60512-11-4))
Degree of protection	IP65/IP68/IP69K

General

Rated current at 40°C	2 A
Rated voltage	30 V AC
	30 V DC
Number of positions	8
Insulation resistance	≥ 100 MΩ

Sensor/actuator cable - SAC-8P-M12MS/ 2,0-28X SH OD - 1407279

Technical data

General

Coding	A - standard
Standards/regulations	M12 connector IEC 61076-2-101
Status display	No
Protective circuit/component	unwired
Degree of pollution	3
Insertion/withdrawal cycles	≥ 100
Torque	0.4 Nm (M12 connector)

Material

Flammability rating according to UL 94	V0
Contact material	CuSn
Contact surface material	Ni/Au
Contact carrier material	PP
Material of grip body	PP
Material, knurls	Stainless steel

Standards and Regulations

Standard designation	M12 connector
Standards/regulations	IEC 61076-2-101
Flammability rating according to UL 94	V0

Cable

Cable type	PE-X black
Cable type (abbreviation)	28X
Cable abbreviation	Li2X2X-C-V1-2X
Conductor cross section	8x 0.25 mm ²
AWG signal line	24
Conductor structure signal line	32x 0.10 mm
Core diameter including insulation	1.17 mm ±0.02 mm
Thickness, insulation	approx. 0.25 mm (Core insulation)
Wire colors	white, brown, green, yellow, gray, pink, blue, red
Overall twist	8 wires around filler to the core
Length of twist, overall twist	67 mm
Shielding	Braided copper wires
Optical shield covering	85 %
External sheath, color	black-gray RAL 7021
Inner sheath thickness	approx. 0.5 mm
Outer sheath thickness	approx. 0.7 mm
External cable diameter D	7.25 mm ±0,3 mm
Minimum bending radius, fixed installation	5 x D
Minimum bending radius, flexible installation	10 x D
Number of bending cycles	1000000

Sensor/actuator cable - SAC-8P-M12MS/ 2,0-28X SH OD - 1407279

Technical data

Cable

Minimum bending radius, drag chain applications	10 x D
Traversing path	10 m
Traversing rate	3 m/s
Acceleration	10 m/s ²
Cable weight	81 kg/km
Outer sheath, material	PE-X
Material, inner sheath	PE-X
Material, filler	PP yarn
Material conductor insulation	PE-X
Conductor material	Bare Cu litz wires
Insulation resistance	≥ 100 MΩ*km (at 20 °C)
Conductor resistance	≤ 78 Ω/km (at 20 °C)
Working capacitance	approx. 80 pF (core-core) approx. 125 pF (core-shield)
Nominal voltage, cable	≤ 300 V AC
Test voltage, cable	≥ 3000 V AC (Spark test)
Test voltage Core/Shield	≥ 1000 V AC (for 10 s)
Special properties	Inductance approx. 0.48 mH/km Irradiated
Flame resistance	According to DIN EN 60332-1-2 according to DIN EN 50266-2-5
Halogen-free	in accordance with DIN VDE 0472 part 815 in accordance with DIN EN 50267-2-1
Resistance to oil	According to DIN EN 60811-2-1, 168 h at 100°C According to DIN EN 50306
Other resistance	Resistance to fuels according to IEC 60811, 168 h at 70°C UV resistant according to DIN VDE 0276-605
Ambient temperature (operation)	-40 °C ... 105 °C (cable, fixed installation) -15 °C ... 105 °C (cable, flexible installation) 20 °C ±5 °C (cable, drag chain applications)

Environmental Product Compliance

	Lead 7439-92-1
China RoHS	Environmentally Friendly Use Period = 50
	For details about hazardous substances go to tab "Downloads", Category "Manufacturer's declaration"

Drawings

Sensor/actuator cable - SAC-8P-M12MS/ 2,0-28X SH OD - 1407279

Schematic diagram

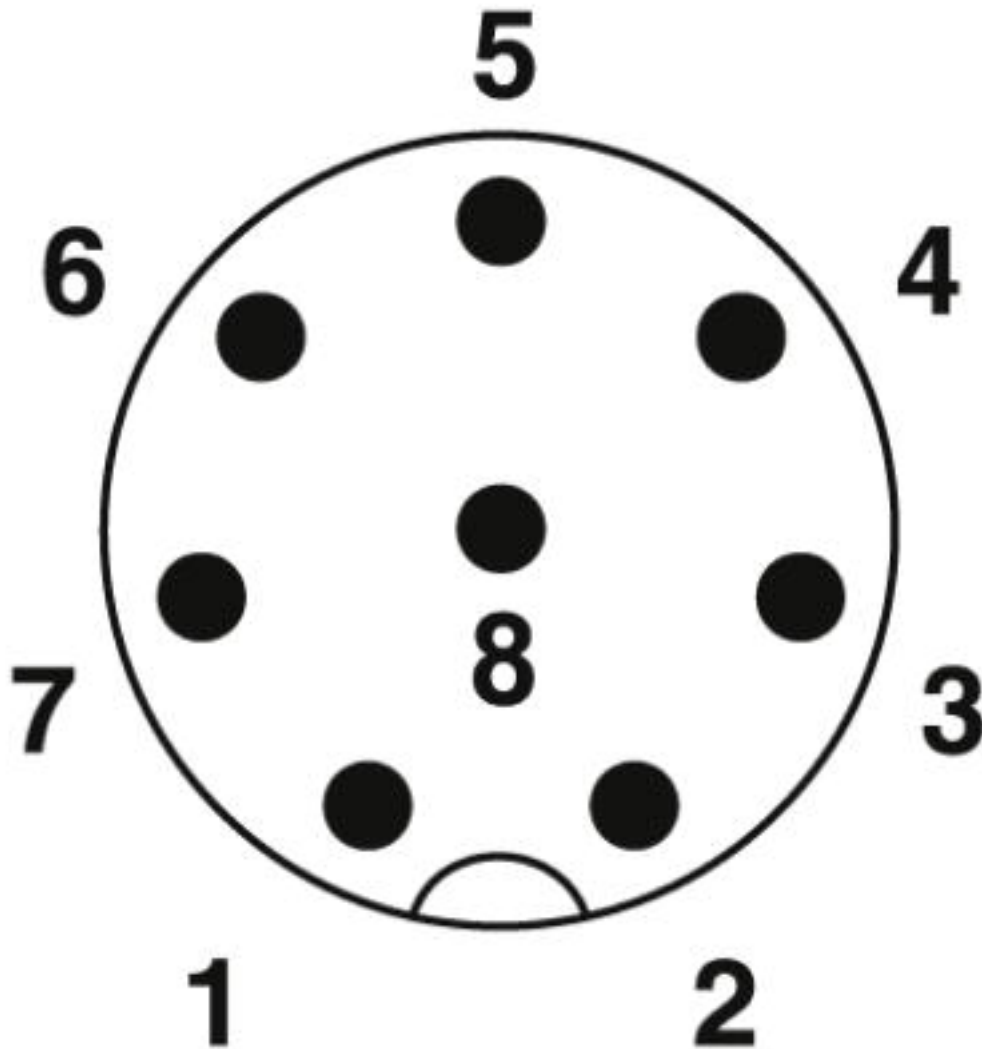

Pin assignment M12 plug, 8-pos., A-coded, view plug side

Sensor/actuator cable - SAC-8P-M12MS/ 2,0-28X SH OD - 1407279

Dimensional drawing

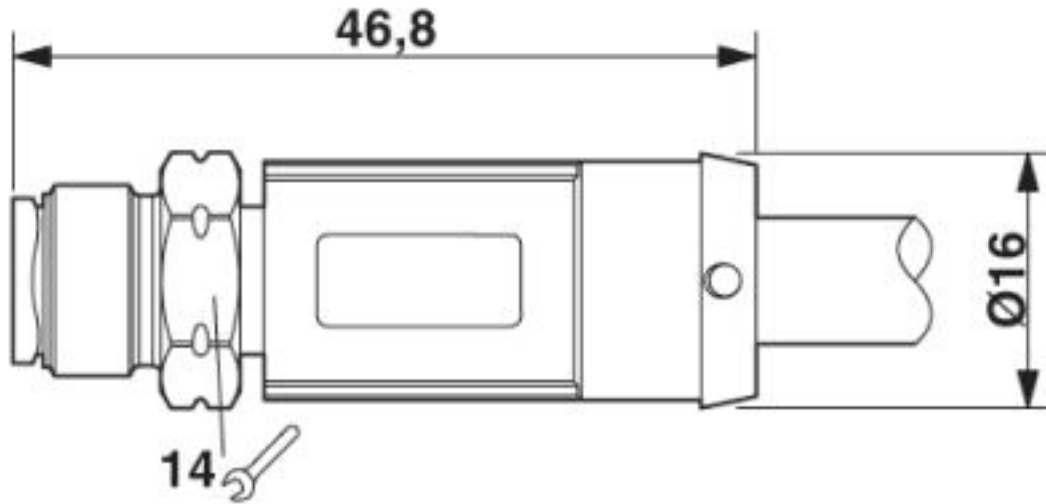

Plug, M12 x 1, straight, shielded

Circuit diagram

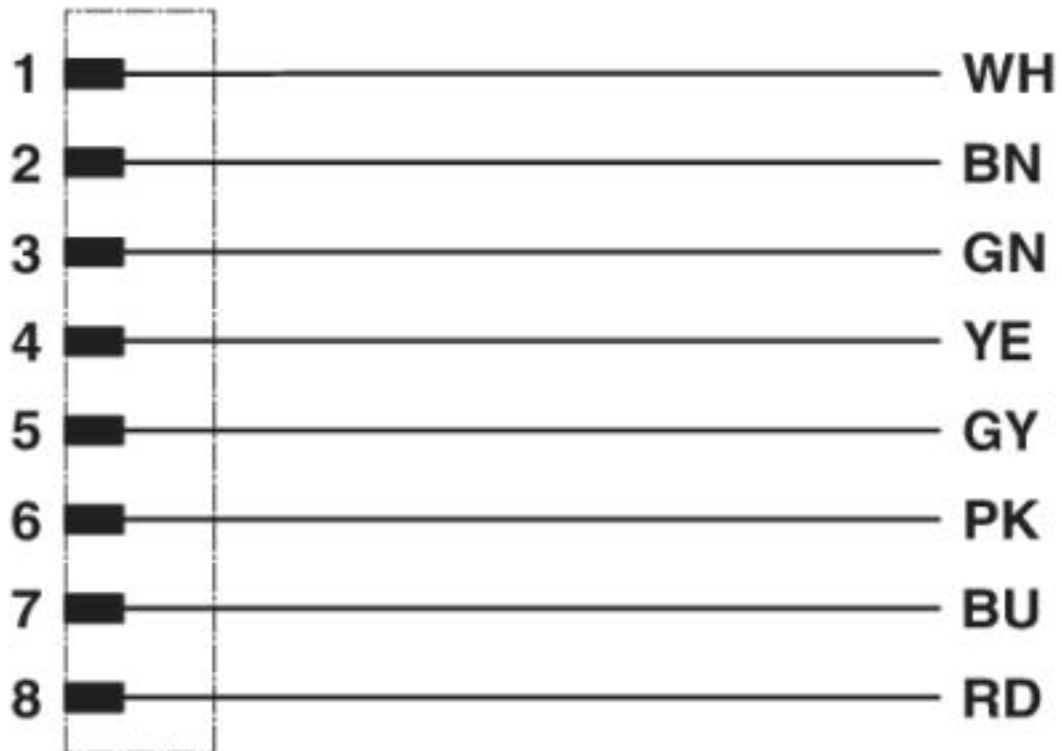

Contact assignment of the M12 plug

Sensor/actuator cable - SAC-8P-M12MS/ 2,0-28X SH OD - 1407279

Cable cross section



PE-X black [28X]

Approvals

Approvals

Approvals

DNV GL / EAC

Ex Approvals

Approval details

Sensor/actuator cable - SAC-8P-M12MS/ 2,0-28X SH OD - 1407279

Approvals

DNV GL		https://approvalfinder.dnvgl.com/	TAE00002K4
--------	---	---	------------

EAC			RU C- DE.BL08.B.00286
-----	---	--	--------------------------

Phoenix Contact 2019 © - all rights reserved
<http://www.phoenixcontact.com>

PHOENIX CONTACT GmbH & Co. KG
Flachsmarktstr. 8
32825 Blomberg
Germany
Tel. +49 5235 300
Fax +49 5235 3 41200
<http://www.phoenixcontact.com>