

User Manual

ITA-3630 Series

**Intel® Gen2/Gen3 Core™ i7/i5/
i3 Fanless Dual Core Compact
Industrial Computer with Wide
Voltage Input**

ADVANTECH

Enabling an Intelligent Planet

Copyright

The documentation and the software included with this product are copyrighted 2014 by Advantech Co., Ltd. All rights are reserved. Advantech Co., Ltd. reserves the right to make improvements in the products described in this manual at any time without notice. No part of this manual may be reproduced, copied, translated or transmitted in any form or by any means without the prior written permission of Advantech Co., Ltd. Information provided in this manual is intended to be accurate and reliable. However, Advantech Co., Ltd. assumes no responsibility for its use, nor for any infringements of the rights of third parties, which may result from its use.

Acknowledgements

The ITA-3630 is trademark of Advantech Co., Ltd.

All other product names or trademarks are properties of their respective owners.

Product Warranty (2 years)

Advantech warrants to you, the original purchaser, that each of its products will be free from defects in materials and workmanship for two years from the date of purchase.

This warranty does not apply to any products which have been repaired or altered by persons other than repair personnel authorized by Advantech, or which have been subject to misuse, abuse, accident or improper installation. Advantech assumes no liability under the terms of this warranty as a consequence of such events.

Because of Advantech's high quality-control standards and rigorous testing, most of our customers never need to use our repair service. If an Advantech product is defective, it will be repaired or replaced at no charge during the warranty period. For out-of-warranty repairs, you will be billed according to the cost of replacement materials, service time and freight. Please consult your dealer for more details.

If you think you have a defective product, follow these steps:

1. Collect all the information about the problem encountered. (For example, CPU speed, Advantech products used, other hardware and software used, etc.) Note anything abnormal and list any onscreen messages you get when the problem occurs.
2. Call your dealer and describe the problem. Please have your manual, product, and any helpful information readily available.
3. If your product is diagnosed as defective, obtain an RMA (return merchandise authorization) number from your dealer. This allows us to process your return more quickly.
4. Carefully pack the defective product, a fully-completed Repair and Replacement Order Card and a photocopy proof of purchase date (such as your sales receipt) in a shippable container. A product returned without proof of the purchase date is not eligible for warranty service.
5. Write the RMA number visibly on the outside of the package and ship it prepaid to your dealer.

Technical Support and Assistance

1. Visit the Advantech website at <http://support.advantech.com> where you can find the latest information about the product.
2. Contact your distributor, sales representative, or Advantech's customer service center for technical support if you need additional assistance. Please have the following information ready before you call:
 - Product name and serial number
 - Description of your peripheral attachments
 - Description of your software (operating system, version, application software, etc.)
 - A complete description of the problem
 - The exact wording of any error messages

A Message to the Customer

Advantech Customer Services

Each and every Advantech product is built to the most exacting specifications to ensure reliable performance in the harsh and demanding conditions typical of industrial environments. Whether your new Advantech equipment is destined for the laboratory or the factory floor, you can be assured that your product will provide the reliability and ease of operation for which the name Advantech has come to be known. Your satisfaction is our primary concern. Here is a guide to Advantech's customer services.

To ensure you get the full benefit of our services, please follow the instructions below carefully.

Technical Support

We want you to get the best performance possible from your products. If you run into technical difficulties, we are here to help. For the most frequently asked questions, you can easily find answers in your product documentation. These answers are normally a lot more detailed than the ones we can give over the phone.

Please consult this manual first. If you still cannot find the answer, gather all the information or questions that apply to your problem, and with the product close at hand, call your dealer. Our dealers are well trained and ready to give you the support you need to get the most from your Advantech products. In fact, most problems reported are minor and can be easily solved over the phone.

In addition, free technical support is available from Advantech engineers every business day. We are always ready to give advice about application requirements or specific information on the installation and operation of any of our products.

Initial Inspection

Before setting up the system, check that the items listed below are included and in good condition. If any item does not accord with the table, please contact your dealer immediately.

- 1 x ITA-3630 series industrial computer
- 1 x ITA-3630 accessory box
- 1 x Warranty card

If any of these items are missing or damaged, contact your distributor or sales representative immediately. We have carefully inspected the ITA-2000/ITA-2000R mechanically and electrically before shipment. It should be free of marks and scratches and in perfect working order upon receipt. As you unpack the ITA-2000/ITA-2000R, check it for signs of shipping damage. (For examples: box damage, scratches, dents, etc.) If it is damaged or it fails to meet the specifications, notify our service department or your local sales representative immediately. Also, please notify the carrier. Retain the shipping carton and packing material for inspection by the carrier. After inspection, we will make arrangements to repair or replace the unit.

Safety Instructions

1. Read these safety instructions carefully.
2. Keep this User Manual for later reference.
3. For plug-in equipment, the power outlet socket must be located near the equipment and must be easily accessible.
4. Keep this equipment away from humidity.
5. Put this equipment on a reliable surface during installation. Dropping it or letting it fall may cause damage.
6. The openings on the enclosure are for air convection. Protect the equipment from overheating. **DO NOT COVER THE OPENINGS.**
7. Make sure the voltage of the power source is correct before connecting the equipment to the power outlet.
8. Position the power cord so that people cannot step on it. Do not place anything over the power cord.
9. All cautions and warnings on the equipment should be noted.
10. If the equipment is not used for a long time, disconnect it from the power source to avoid damage by transient overvoltage.
11. Never pour any liquid into an opening. This may cause fire or electrical shock.
12. Never open the equipment. For safety reasons, the equipment should be opened only by qualified service personnel.
13. If one of the following situations arises, get the equipment checked by service personnel:
 - The power cord or plug is damaged.
 - Liquid has penetrated into the equipment.
 - The equipment has been exposed to moisture.
 - The equipment does not work well, or you cannot get it to work according to the user's manual.
 - The equipment has been dropped and damaged.
 - The equipment has obvious signs of breakage.
14. **DO NOT LEAVE THIS EQUIPMENT IN AN ENVIRONMENT WHERE THE STORAGE TEMPERATURE MAY GO BELOW -20° C (-4° F) OR ABOVE 60° C (140° F). THIS COULD DAMAGE THE EQUIPMENT. THE EQUIPMENT SHOULD BE IN A CONTROLLED ENVIRONMENT.**
15. **CAUTION: DANGER OF EXPLOSION IF BATTERY IS INCORRECTLY REPLACED. REPLACE ONLY WITH THE SAME OR EQUIVALENT TYPE RECOMMENDED BY THE MANUFACTURER, DISCARD USED BATTERIES ACCORDING TO THE MANUFACTURER'S INSTRUCTIONS.**

The sound pressure level at the operator's position according to IEC 704-1:1982 is no more than 70 dB (A).

DISCLAIMER: This set of instructions is given according to IEC 704-1. Advantech disclaims all responsibility for the accuracy of any statements contained herein.

Safety Precaution - Static Electricity

Follow these simple precautions to protect yourself from harm and the products from damage.

- To avoid electrical shock, always disconnect the power from your PC chassis before you work on it. Don't touch any components on the CPU card or other cards while the PC is on.
- Disconnect power before making any configuration changes. The sudden rush of power as you connect a jumper or install a card may damage sensitive electronic components.

Battery Information

Batteries, battery packs and accumulators should not be disposed of as unsorted household waste. Please use the public collection system to return, recycle, or treat them in compliance with the local regulations.



Contents

Chapter 1	Overview	1
1.1	Introduction	2
1.2	Specifications	2
1.3	Power Information	2
	Table 1.1: Power	2
1.4	Environmental Specifications	3
	Table 1.2: Environmental Specifications	3
1.5	Dimension Diagram	3
	Figure 1.1 Dimension Diagram of ITA-3630	3
	Figure 1.2 Exploded Diagram of ITA-3630	4
	Table 1.3: Part List	4
Chapter 2	H/W Installation	5
2.1	Introduction	6
2.2	Jumpers and Connectors	6
2.2.1	Jumper Description	6
2.2.2	Jumper and Connector Location	7
	Figure 2.1 Jumper and Connector Location on Main Board	7
	Table 2.1: Jumpers	7
	Table 2.2: JLVDS1: LVDS Voltage Selection	8
	Table 2.3: JCOMS1: CMOS Clear Function	8
	Table 2.4: PSON1: Startup-up Mode Selection	8
	Table 2.5: VCCGPIO1: GPIO Voltage Selection	8
2.3	I/O Connectors	9
	Figure 2.2 ITA-3630-S0A1E Rear I/O Interfaces	9
	Figure 2.3 ITA-3630 Front I/O Interfaces	9
2.3.1	COM Connector	10
	Table 2.6: COM Connector Pin Definition	10
2.3.2	HDMI Connector	10
	Table 2.7: HDMI Connector Pin Definition	10
2.3.3	VGA Connector	11
	Table 2.8: VGA Connector Pin Definition	11
2.3.4	USB 2.0 Connector	11
	Table 2.9: USB2.0 Connector Pin Definition	11
2.3.5	USB 3.0 Connector	12
	Table 2.10: USB3.0 Connector Pin Definition	12
2.3.6	DIO Connector	12
	Table 2.11: DIO Connector Pin Definition	12
2.3.7	Audio in Connector	12
2.3.8	PS/2 Connector	13
	Table 2.12: PS/2 Connector Pin Definition	13
2.3.9	LAN Connector	13
	Table 2.13: Ethernet Connector Pin Definition	13
	Table 2.14: LED Color Definition	13
2.3.10	Phoenix Terminal Connector	14
	Table 2.15: Power Connector Pin Definition	14
2.3.11	LPT Connector	14
	Table 2.16: LPT Connector Pin Definition	14
2.3.12	LVDS Connector	15
	Table 2.17: LVDS Connector Pin Definition	15
2.3.13	LED Indicators for System Status	15

Chapter 3 System Setup 17

3.1	Introduction	18
3.1.1	Installing Mainboard mini-PCIe card and mini SATA.....	18
	Figure 3.1 Installing Mainboard mini-PCIe card and mini SATA	18
3.1.2	Installing USB Dongle.....	19
	Figure 3.2 Installing USB Dongle	19
3.1.3	Installing HDD Module	20
	Figure 3.3 Installing HDD Module.....	20
	Figure 3.4 Installing HDD+CF Module.....	21
3.1.4	Installing Foot Stand	21
	Figure 3.5 Installing Foot Stand.....	21
3.1.5	Installation Notes	22
	Figure 3.6 Desktop Mount	22
	Figure 3.7 Wall Mount	22

Chapter 4 BIOS Setting 23

4.1	Introduction	24
	Figure 4.1: Setup Program Initial Screen	24
4.2	Entering Setup	24
	Figure 4.2: POST Screen	24
4.2.1	Main Setup.....	25
	Figure 4.3: Main Setup Screen.....	25
4.2.2	Advanced BIOS Features Setup.....	26
	Figure 4.4: Advanced BIOS Features Setup Screen.....	26
	Figure 4.5 ACPI Configuration.....	26
	Figure 4.6: CPU Configuration (1).....	27
	Figure 4.7 CPU Configuration (2).....	27
	Figure 4.8 SATA Configuration.....	28
	Figure 4.9: USB Configuration.....	29
	Figure 4.10:Super I/O Configuration.....	30
	Figure 4.11 Serial Port Configuration	30
	Figure 4.12:H/W Monitor COnfiguration	31
	Figure 4.13:CPU PPM Configuration.....	32
	Figure 4.14:APM Configuration	33
4.2.3	Advanced Chipset Features Setup	33
	Figure 4.15Advanced Chipset Features Setup.....	33
	Figure 4.16PCH-IO Configuration	34
	Figure 4.17Chipset USB Configuration	34
	Figure 4.18PCH Azalia Configuration.....	35
	Figure 4.19:System Agent (SA) Configuration.....	36
	Figure 4.20Graphics Configuration Menu.....	36
	Figure 4.21LCD Control.....	37
4.2.4	Boot Setup	38
	Figure 4.22:Boot Setup.....	38
	Figure 4.23Boot Option Priorities	39
	Figure 4.24:CSM Parameter.....	39
4.2.5	Security Setup	40
	Figure 4.25:Setup Security Menu	40
4.2.6	Save & Exit Setup.....	41
	Figure 4.26:Setup Save & Exit Menu.....	41

Chapter 5 Driver Installation..... 43

5.1	Introduction	44
5.2	Driver Installation	44
5.2.1	Chipset Windows Driver Setup	45

5.2.2	VGA Windows Driver Setup	45
5.2.3	ME Windows Driver Setup	46
5.2.4	LAN Windows Driver Setup	46
5.2.5	USB 3.0 Windows Driver Setup	47
5.2.6	Audio Windows Driver Installation	47

Chapter 6 **GPIO Programming Guide49**

6.1	ITA-3630 Digital DIO Definition	50
6.2	Configuration Sequence	50
6.3	Function Call for Reference	54

Appendix A **Programming the Watchdog Timer..59**

A.1	Programming the Watchdog Timer	60
A.1.1	Watchdog Timer Overview.....	60
A.1.2	Programming the Watchdog Timer	60
	Table A.1: Watchdog Timer Registers	60
A.1.3	Example Program	61

Chapter 1

Overview

Sections include:

- Introduction
- Specifications
- Power Information
- Environment Specifications
- Dimension Diagram

1.1 Introduction

The ITA-3630 is a fan-less, compact embedded industrial computer chassis with Core™ i7/i5/i3 dual core processor and wide voltage input range, which is specially designed for intelligent transportation - Road Surveillance. This powerful computing platform can stand operation 24 hours a day, 7 days a week.

1.2 Specifications

- **Processor and Chipset:** Core™ i7/i5/i3 processor + Intel® HM76 chipset
- **BIOS:** AMI SPI 64 Mb Flash
- **Memory:** On-board 4 GB DDR3 1333/1600 MHz
- **Display:** Integrated graphics HD4000, with up to 256 MB SDRAM shared system memory
- **Dual Display:**
 - Single display resolution up to 2048 x 1536 @ 60 Hz
 - Dual Display resolution up to 1920 x 1200 @ 60 Hz
- **Storage:** Supports 2 x 2.5" HDD slot or 1 x CF slot and 1 x 2.5" HDD slot
- **Expansion Slot:** Supports 1 x Mini PCIe slot
- **Ethernet:** 2 x 10/100/1000M Ethernet (Controller chip: Intel i210-AT)
- **USB:** 4 x USB2.0 and 2 x USB 3.0
- **VGA:** 1 x VGA
- **HDMI:** 1 x HDMI
- **LVDS:** 1 x LVDS (Reserved pin header on main board)
- **Serial I/O:** 2 x DB9, RS232/422/485 with automatic flow control
- **Digital I/O:** 1 x 8-ch GPIO
- **Audio:** 1 x Speaker out with 2 x 4 w amplifier; 1 Mic input
- **Reserved Zone:**
 - 1 x LPT
 - 1 x LVDS
 - 2 x VGA (Optional PCA-5650 graphic card expansion for 2 VGA)
- **Dimensions (W x H x D):**
 - 213 x 82.7 x 240 mm (without ears)
 - 253 x 86.6 x 240 mm (with ears)
- **Weight:** 3.75 kg

1.3 Power Information

ITA-3630 supports DC 9 ~ 36 V wide voltage input

Table 1.1: Power

DC voltage input	9 V - 36 V
DC current	7.2 A - 1.8 A
DC power interface	2-pin terminal block

1.4 Environmental Specifications

Table 1.2: Environmental Specifications	
Operating Temperature	With industrial HDD: 0 ~ 40°C With CF card: -25 ~ 60 °C (With 0.7 m/s airflow)
Safety Certificate Temperature	-10 ~ 50°C (With industrial standard SSD/CF/mSATA)
Storage Temperature	-40 ~ 85°C
Humidity	95% @ 40° C, non-condensing
Vibration	With Compact Flash: 2 Grms @ 5 ~ 500 Hz, random, 1 hr/axis
	With 2.5" HDD: 1 Grms @ 5 ~ 500 Hz, random, 1 hr/axis
	IEC60068-2-6 Sine 2G @ 5 ~ 500Hz, 1hr/axis
Shock	With Compact Flash: 20G, IEC-68-2-27, half-sine wave, 11 ms duration
	With 2.5" HDD: 10G, IEC-68-2-27, half-sine wave, 11 ms duration
Safety	UL, CCC, BSMI, CE and FCC compliant

1.5 Dimension Diagram

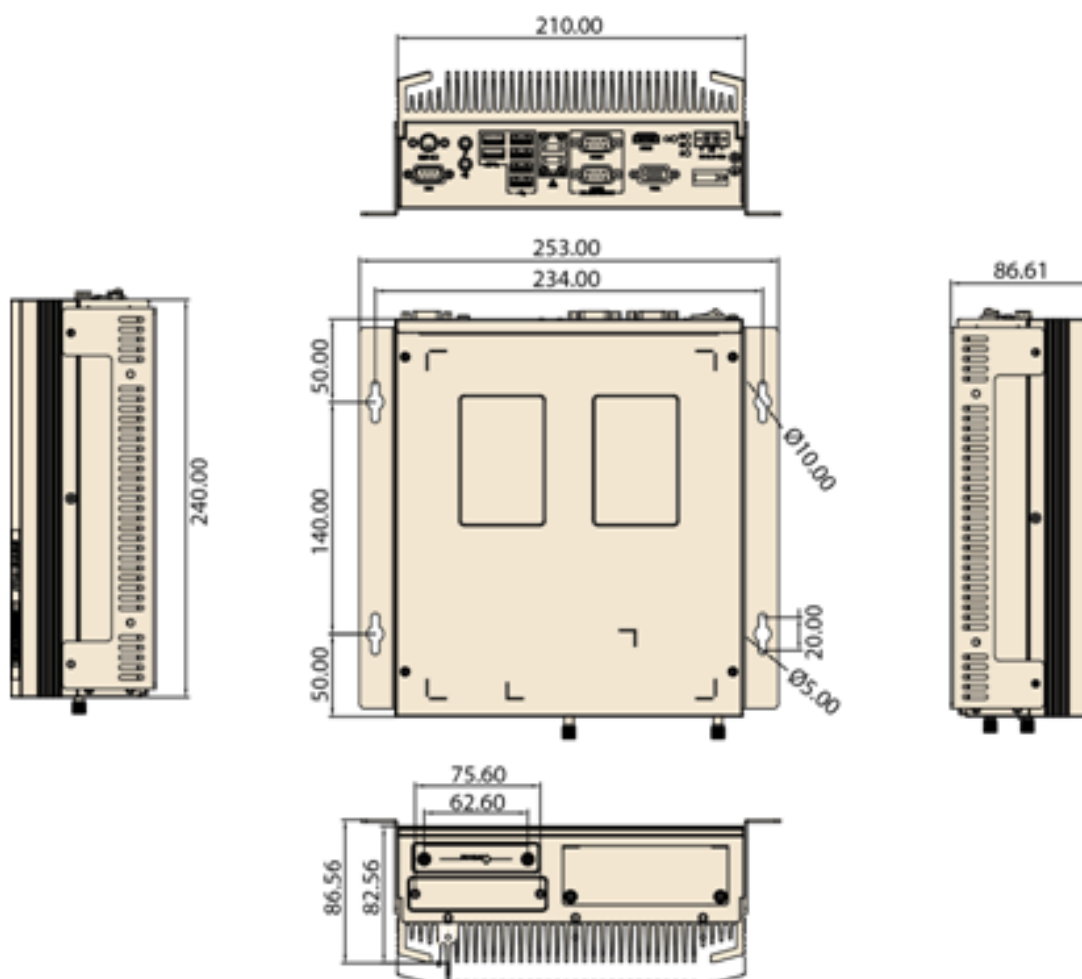

Figure 1.1 Dimension Diagram of ITA-3630

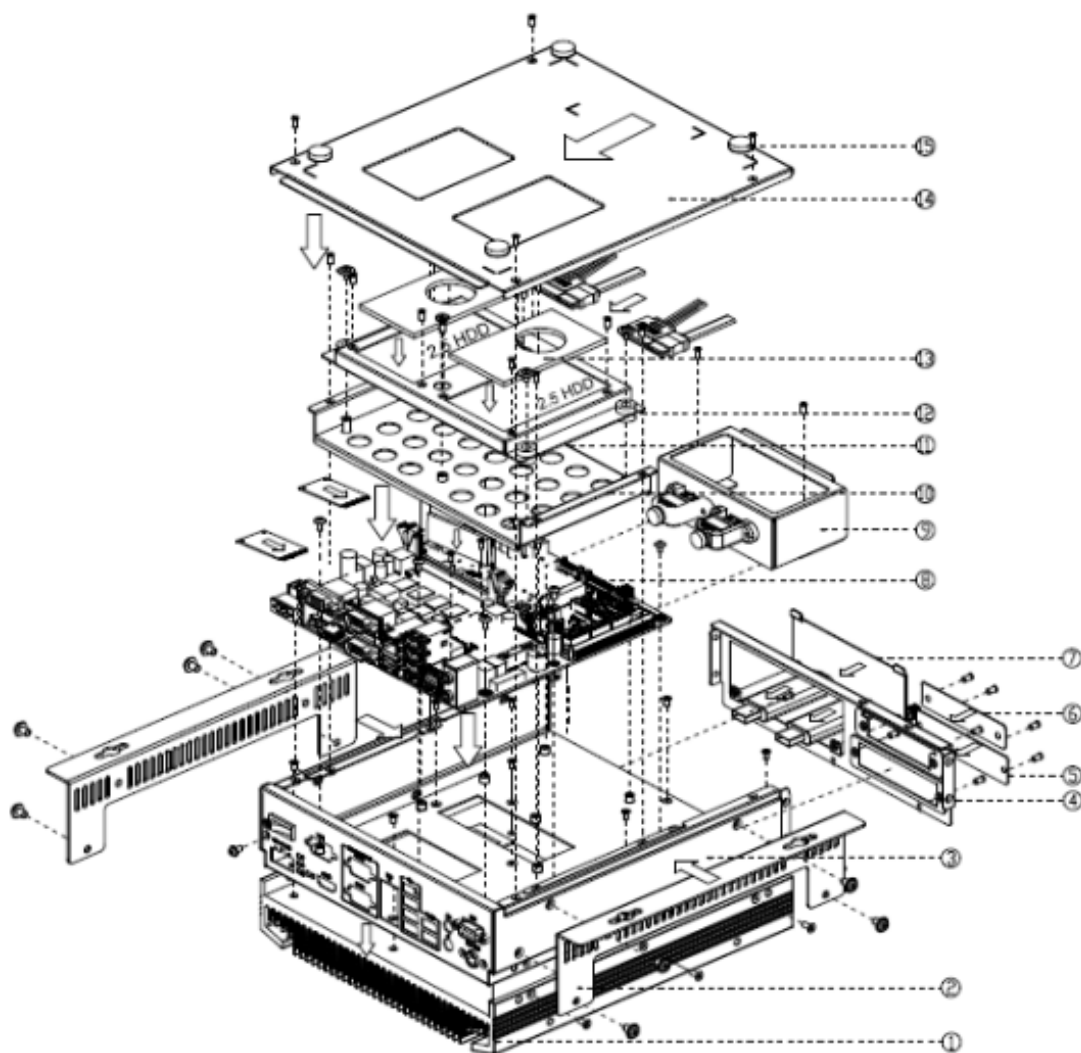

Figure 1.2 Exploded Diagram of ITA-3630

Table 1.3: Part List

1	Heat sink	9	USB tray
2	Chassis foot stand	10	HDD Tray
3	Chassis	11	2.5" HDD fix bracket
4	Front panel	12	HDD buffer rubber
5	Blank bracket	13	Thermal pad
6	Blank bracket (CF)	14	Top cover
7	USB bracket	15	Rubber foot pad
8	Main board		

Chapter 2

H/W Installation

Sections include:

- Introduction
- Jumpers and Connectors
- I/O Connectors

2.1 Introduction

The following sections show the internal jumpers setting and the external connectors pin assignment for application integration.

2.2 Jumpers and Connectors

2.2.1 Jumper Description

You may configure the ITA-3630 to match the needs of your application by setting jumpers. A jumper is a metal bridge used to close an electric circuit. It consists of two metal pins and a small metal clip (often protected by a plastic cover) that slides over the pins to connect them. To close a jumper, you remove the clip. Sometime a jumper will have three pins, labelled 1, 2 and 3. In this case you would connect either pins 1 and 2, or 2 and 3.

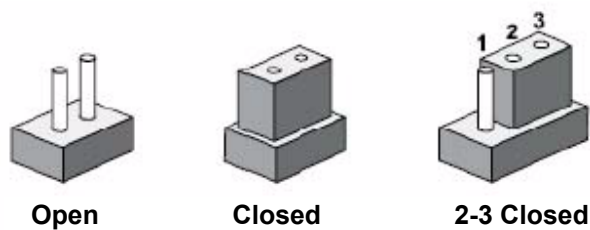

The jumpers setting are schematically depicted in this manual as follows.

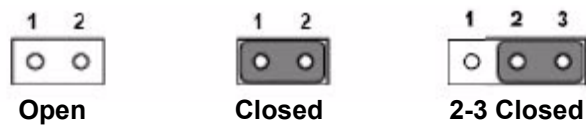

A pair of needle-nose pliers may be helpful when working with jumpers. If you have any doubts about the best hardware configuration for your application, contact your local distributor or sales representative before you make any changes. Generally, you simply need a standard cable to make most connections.

2.2.2 Jumper and Connector Location

The board has a number of connectors and jumpers that allow you to configure your system to suit your application. The table below lists the function of each of the connectors and jumpers. The locations of jumpers and connector on the board are shown in Figure 2.1.

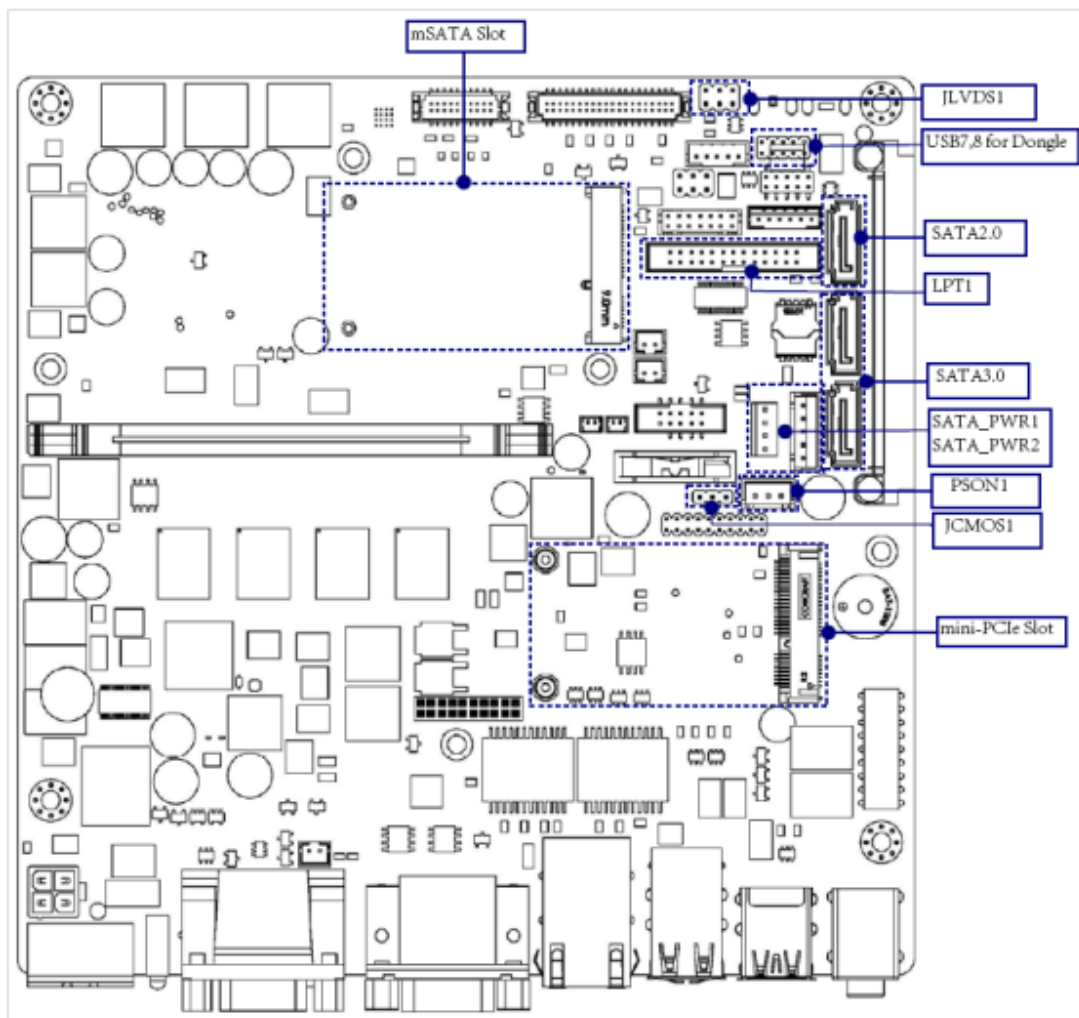

Figure 2.1 Jumper and Connector Location on Main Board

Table 2.1: Jumpers

Label	Function
JLVD81	LVDS voltage selection
JCMS1	Clear CMOS settings
PSON1	Start-up mode selection
VCCGPIO1	GPIO voltage selection

Table 2.2: JLVDS1: LVDS Voltage Selection

Closed Pins	Setting
3-4	+V12
2-4	+V5
4-6	Normal (+V3.3)*

*Default setting

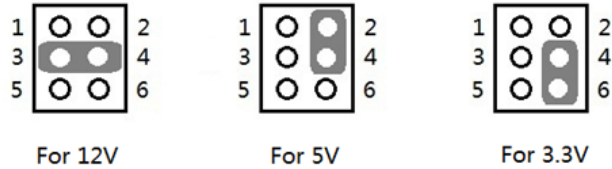

Table 2.3: JCOMS1: CMOS Clear Function

Closed Pins	Setting
1-2	Default*
2-3	Clear CMOS

* Default setting



Table 2.4: PSON1: Startup-up Mode Selection

Closed Pins	Setting
1-2	AT Mode
2-3	ATX Mode*

* Default setting



Table 2.5: VCCGPIO1: GPIO Voltage Selection

Closed Pins	Setting
1-3	+V5_SB
2-4	Normal (+V3_SB)*
3-5	+V5
4-6	+V3.3

* Default setting

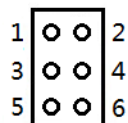

2.3 I/O Connectors

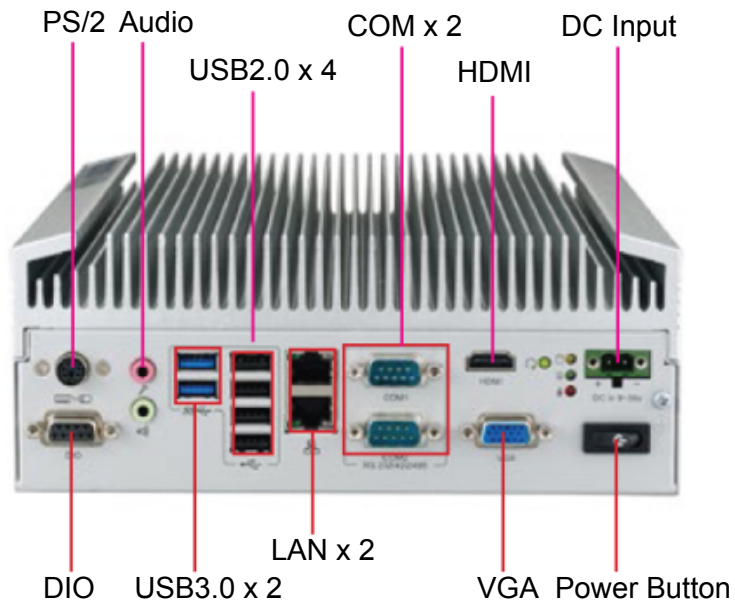

Figure 2.2 ITA-3630-S0A1E Rear I/O Interfaces

Reserved I/O connector for LPT/LVDS/COM via a cable

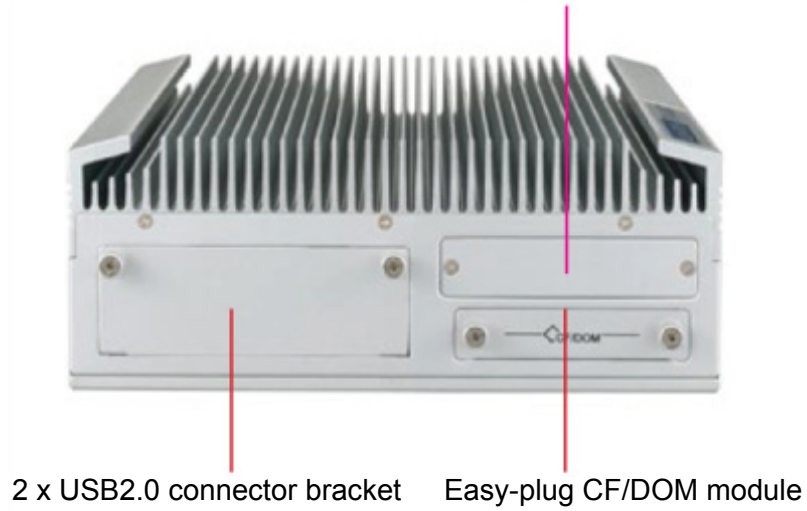

Figure 2.3 ITA-3630 Front I/O Interfaces

2.3.1 COM Connector

ITA-3630 provides two D-sub 9-pin connectors for RS-232/422/485. The default setting is RS-232.

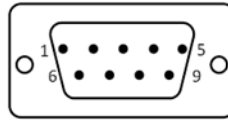

Table 2.6: COM Connector Pin Definition

	RS-232	RS-422	RS-485
Pin	Signal Name	Signal Name	Signal Name
1	DCD	Tx-	DATA-
2	RxD	Tx+	DATA+
3	TxD	Rx+	NC
4	DTR	Rx-	NC
5	GND	GND	GND
6	DSR	NC	NC
7	RTS	NC	NC
8	CTS	NC	NC
9	RI	NC	NC

2.3.2 HDMI Connector

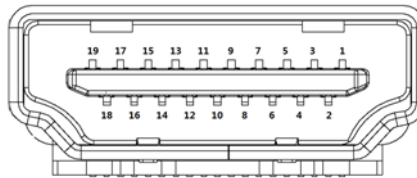

Table 2.7: HDMI Connector Pin Definition

Pin	Signal Name	Signal Name	Signal Name
1	TMDS Data2+	11	TMDS Clock Shiled
2	TMDS Data2 Shiled	12	TMDS Clock-
3	TMDS Data2-	13	CEC
4	TMDS Data1+	14	Reserved
5	TMDS Data1 Shiled	15	SCL
6	TMDS Data1-	16	SDA
7	TMDS Data0+	17	DDC/CEC Ground
8	TMDS Data0 Shiled	18	+5V Power
9	TMDS Data0-	19	Hot Plug Detect
10	TMDS Clock+		

2.3.3 VGA Connector

ITA-3630 offers one D-sub 15-pin female connector, which supports max. resolution of 2048 x 1563.

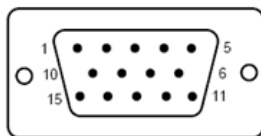

Table 2.8: VGA Connector Pin Definition

Pin	Signal Name	Pin	Signal Name
1	Red	9	+5V
2	Green	10	GND
3	Blue	11	NC
4	NC	12	DDC-DATA
5	GND	13	H-SYNC
6	GND	14	V-SYNC
7	GND	15	DDC-CLK
8	GND	?	?

2.3.4 USB 2.0 Connector

ITA-3630 provides four USB interface connectors, which are USB UHCI, Rev. 2.0 compliant. The USB interface can be disabled in the system BIOS setup.

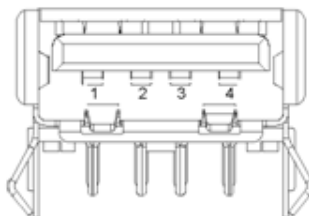

Table 2.9: USB2.0 Connector Pin Definition

Pin	Signal Name	Pin	Signal Name
1	+V5(VCC)	3	USB DATA+
2	USB DATA-	4	GND

2.3.5 USB 3.0 Connector

ITA-3630 provides two USB interface connectors, which are USB UHCI, Rev. 3.0 compliant. The USB interface can be disabled in the system BIOS setup.

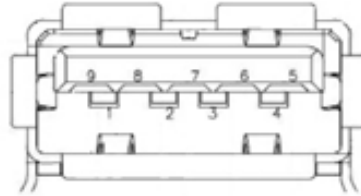

Table 2.10: USB3.0 Connector Pin Definition

Pin	Signal Name	Pin	Signal Name
1	+V5(VCC)	6	StdA_SSRX+
2	D-	7	GND_DRAIN
3	D+	8	StdA_SSTX-
4	GND	9	StdA_SSTX+
5	StdA_SSRX-		

2.3.6 DIO Connector

ITA-3630 provides one 8-bit DIO, D-sub 9-pin male connector without isolation protection.

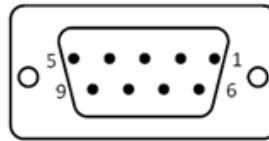
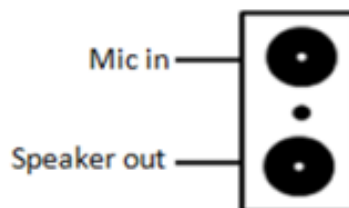

Table 2.11: DIO Connector Pin Definition

Pin	Signal Name	Pin	Signal Name
1	GPIO0	6	GPIO4
2	GPIO1	7	GPIO5
3	GPIO2	8	GPIO6
4	GPIO3	9	GPIO7
5	GND	?	?

2.3.7 Audio in Connector

ITA-3630 provides one integrated Mic-in/speaker out audio connector.



2.3.8 PS/2 Connector

ITA-3630 provides a PS/2 keyboard and mouse connector.

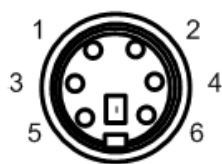

Table 2.12: PS/2 Connector Pin Definition

Pin	Signal Name	Pin	Signal Name
1	KB_Z_DAT	4	+V5_PS2
2	MS_Z_DAT	5	KB_Z_CLK
3	GND	6	MS_Z_CLK

2.3.9 LAN Connector

ITA-3630 provides two RJ-45 Ethernet connectors with LEDs indicating network status.

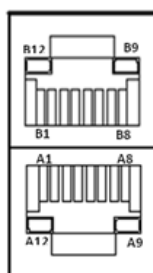

Table 2.13: Ethernet Connector Pin Definition

Pin	Signal Name	Signal Name
A1/B1	MDIO0+	MDIO0+
A2/B2	MDIO0-	MDIO0-
A3/B3	MDIO1+	MDIO1+
A4/B4	MDIO2+	MDIO2+
A5/B5	MDIO2-	MDIO2-
A6/B6	MDIO1-	MDIO1-
A7/B7	MDIO3+	MDIO3+
A8/B8	MDIO3-	MDIO3-
A9/B9	LED GREEN-	LED GREEN-
A10/B10	LED GREEN+	LED GREEN+
A11/B11	1000M LED	1000M LED
A12/B12	100m/10M LED	100m/10M LED

Table 2.14: LED Color Definition

GB Connection	Green (Upper left LED)
MB Connection	Orange (Upper left LED)
Connection Status	Green, flickering (Upper right LED)

2.3.10 Phoenix Terminal Connector

ITA-3630 provides one 2-pin phoenix terminal connector for 9 V ~ 36 V power input.

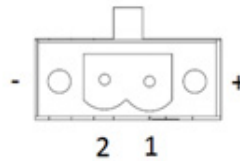

Table 2.15: Power Connector Pin Definition

Pin	Signal Name	Pin	Signal Name
1	Positive pole	2	GND

2.3.11 LPT Connector

ITA-3630 provides one parallel connector (optional), which can be connected to the reserved position on front panel via a cable.

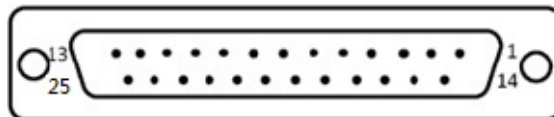

Table 2.16: LPT Connector Pin Definition

Pin	Signal Name	Pin	Signal Name
1	LPT_z_STB#	14	LPT_AFD#
2	LPT_z_PD0	15	LPT_ERR#
3	LPT_PD1	16	LPT_INIT#
4	LPT_PD2	17	LPT_SLIN#
5	LPT_PD3	18	GND
6	LPT_PD4	19	GND
7	LPT_PD5	20	GND
8	LPT_PD6	21	GND
9	LPT_PD7	22	GND
10	LPT_ACK#	23	GND
11	LPT_BUSY	24	GND
12	LPT_PE	25	GND
13	LPT_SLCT		

2.3.12 LVDS Connector

ITA-3630 provides one LPT connector (optional), which can be connected to the reserved position on front panel via a cable.

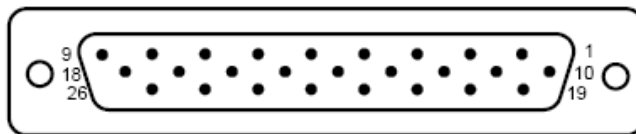

Table 2.17: LVDS Connector Pin Definition

Pin	Signal Name	Pin	Signal Name
1	TXL0+	2	TXL1+
3	TXL2+	4	TXL3+
5	TXU0+	6	TXU1+
7	TXU2+	8	TXU3+
9	TXU3-	10	TXLCLK-
11	TXL0-	12	TXL1-
13	TXL2-	14	TXL3-
15	TXU0-	16	TXU1-
17	TXU2-	18	TXUCLK+
19	TXLCLK+	20	LVCC
21	BLENABLE	22	GND
23	GND	24	GND
25	GND	26	GND

2.3.13 LED Indicators for System Status

LEDs on the rear panel are used to indicate system health and active status. For detailed information of LED definition, please refer to below table.

Item	LED	Status	Color	Description
1	PWR	On	Green	System power is on and system is safe.
2	HDD	On	Yellow	There is data receiving and transmitting on SATA.
		Off		There is no data receiving and transmitting on SATA.

Chapter 3

System Setup

Sections include:

- Installing Mainboard mini-PCIe card and mini SATA
- Installing USB Dongle
- Installing HDD Module
- Installing Foot Stand
- Installing Notes

3.1 Introduction

The following procedures will instruct you to install all modules into the ITA-3630 system.

3.1.1 Installing Mainboard mini-PCle card and mini SATA

1. ITA-3630 mainboard has a mini-PCle slot and a mini SATA slot. Each one has a label for users to distinguish.
2. Insert mini-PCle card and mSATA card to the respective slot and fix with two screws.

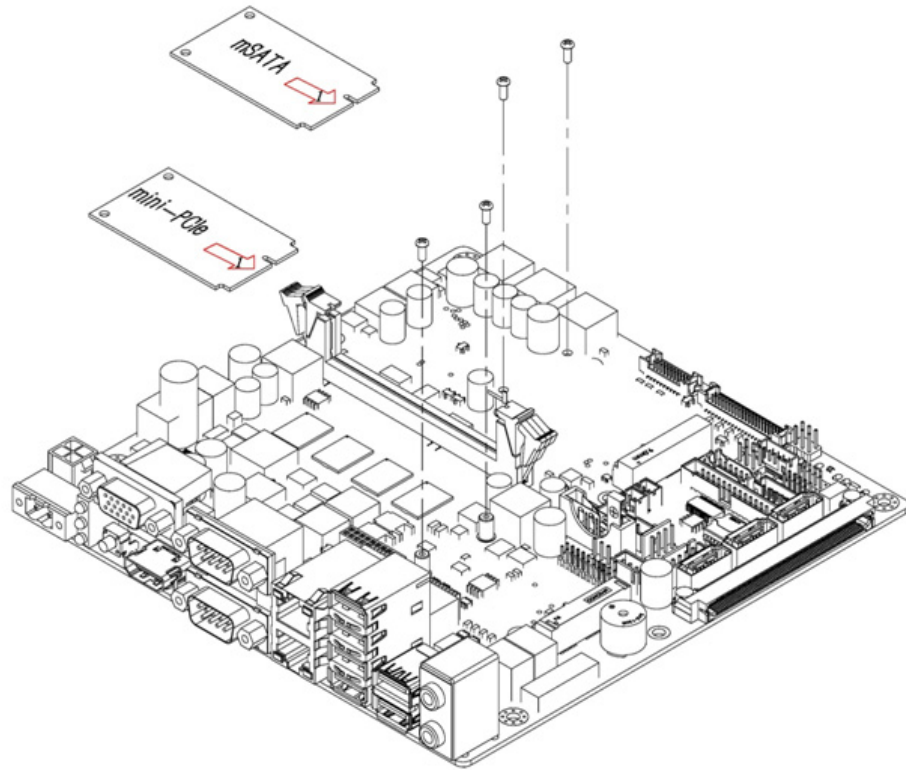

Figure 3.1 Installing Mainboard mini-PCle card and mini SATA

3.1.2 Installing USB Dongle

1. Remove the screws near USB blade on front panel, then open the front cover.
2. Insert USB Dongle into USB socket.
3. Replace the front cover and fix it with the screws.

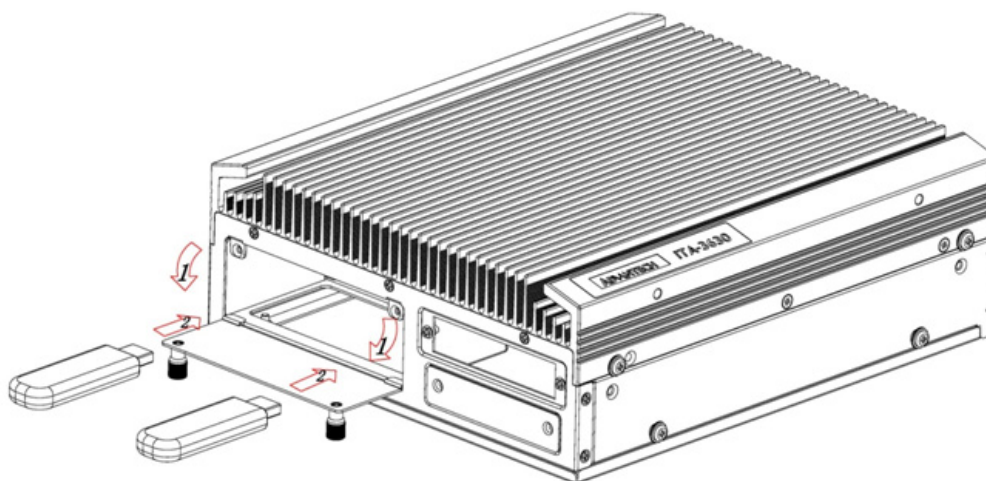

Figure 3.2 Installing USB Dongle

3.1.3 Installing HDD Module

The ITA-3630 reserves a space for dual HDD module and HDD+CF module. Please refer to the following instructions to install the hard disk drive.

1. Place the HDD into 2.5" HDD holder and fill in 4 rubbers.
2. Place two HDDs onto HDD holder, and secure them with 8 screws, then sitck the cooling pad.
3. Place HDD holder onto HDD bracket and secure it with 4 screws.
4. Connect the complete HDD module to the chassis and fix it with screws.

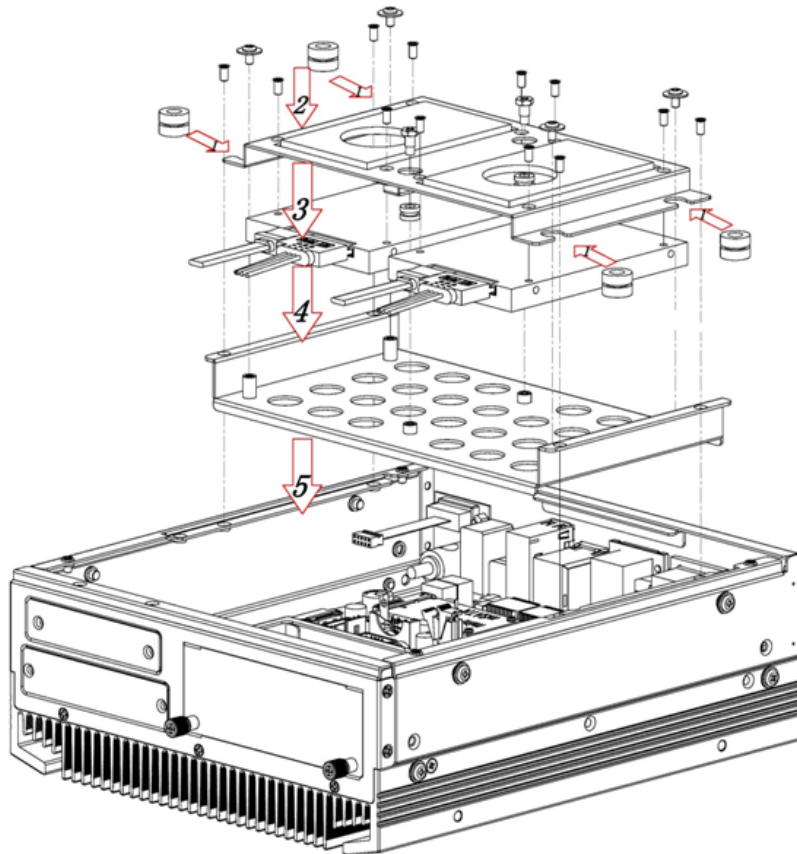

Figure 3.3 Installing HDD Module

1. Place rubbers into HDD holder.
2. Fix HDD onto the holder with 4 screws and sitck the cooling pad.
3. Place HDD holder onto HDD bracket and secure it with screws.
4. Place HDD bracket onto the chassis.
5. Fix CF module board onto CF tray.
6. Insert the CF card into CF module board and fix it with fixed plastic shell.
7. Place CF tray onto HDD bracket and secure it with the screws.

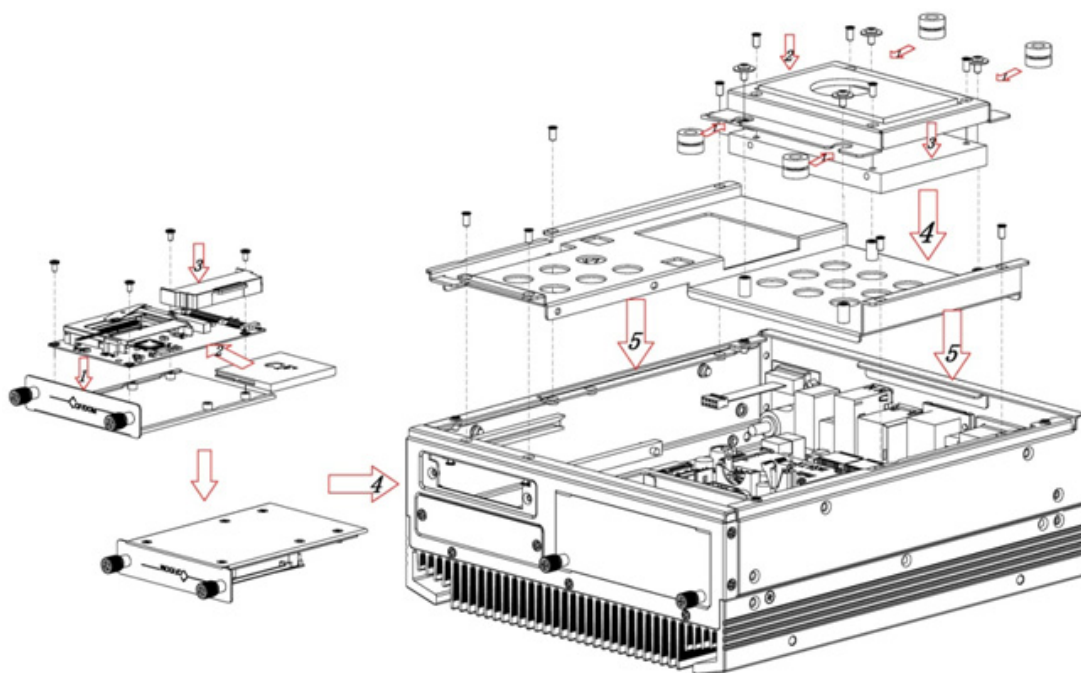

Figure 3.4 Installing HDD+CF Module

3.1.4 Installing Foot Stand

Align the 2 foot stands with the screw holes in the chassis side panel, and secure them with screws.

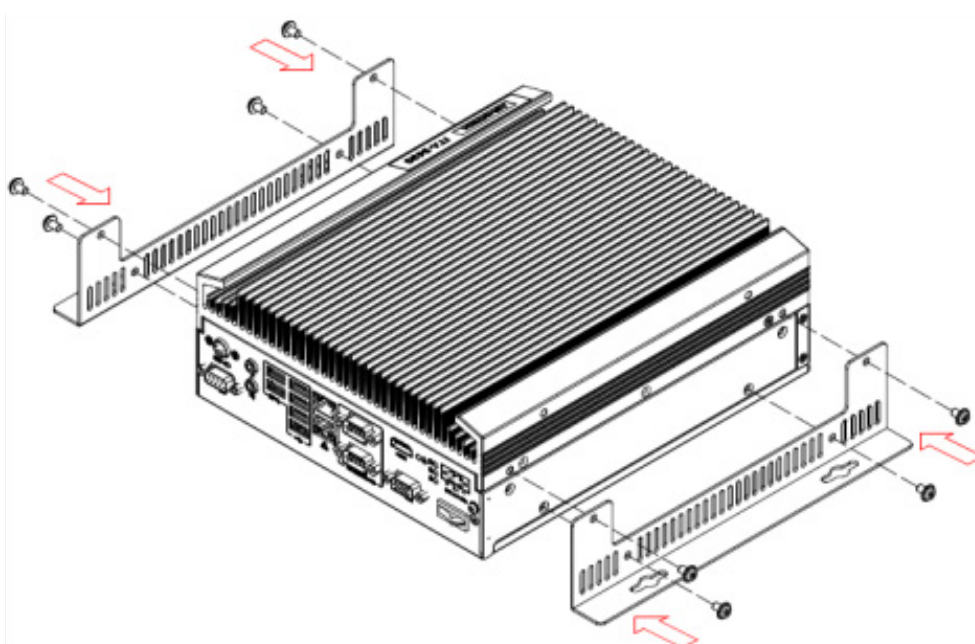

Figure 3.5 Installing Foot Stand

3.1.5 Installation Notes

When the computer is running, no object should be placed within 30 mm above the heatsink to avoid the impact on airflow.

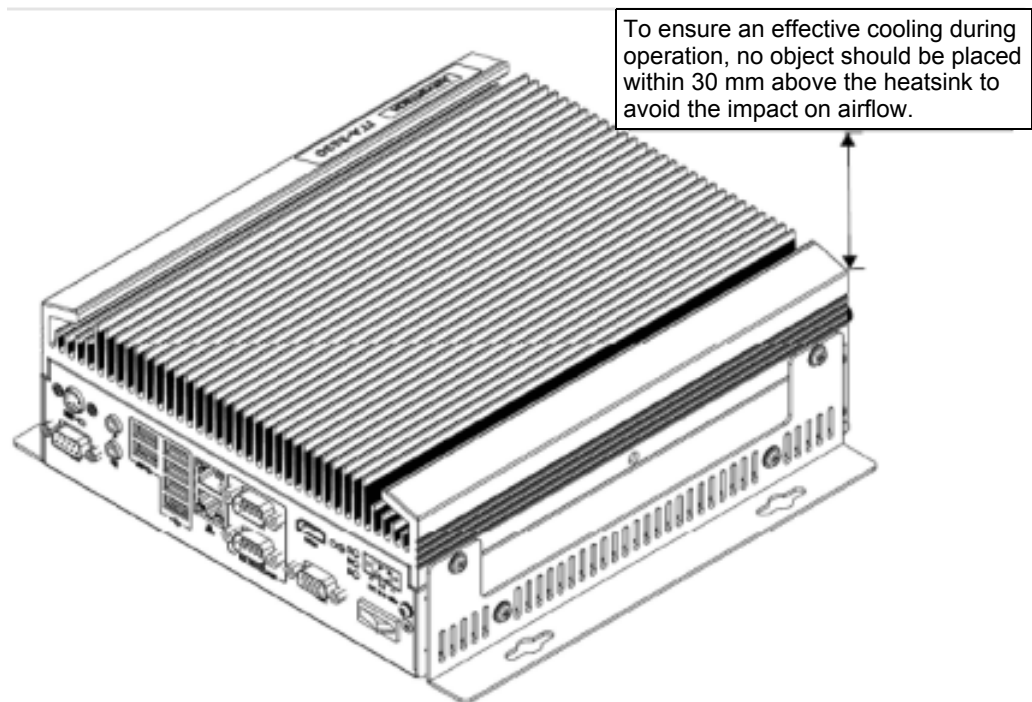

Figure 3.6 Desktop Mount

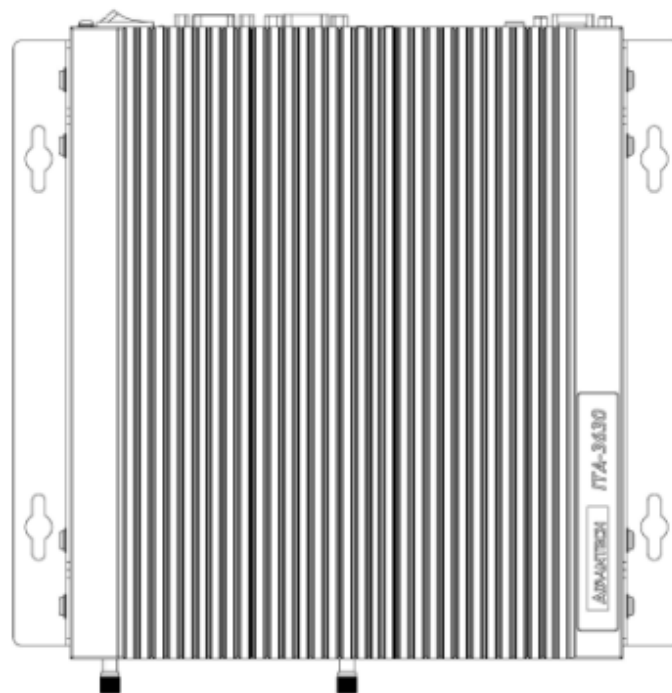

Figure 3.7 Wall Mount

Chapter 4

BIOS Setting

4.1 Introduction

AMIBIOS has been integrated into many motherboards for over a decade. This chapter introduces how to configure BIOS for ITA-3630 series. With the AMIBIOS Setup program, you can modify BIOS settings and control the special features of your computer. The Setup program uses a number of menus for making changes and turning the special features on or off. This chapter describes the basic navigation of the ITA-3630 setup screens.

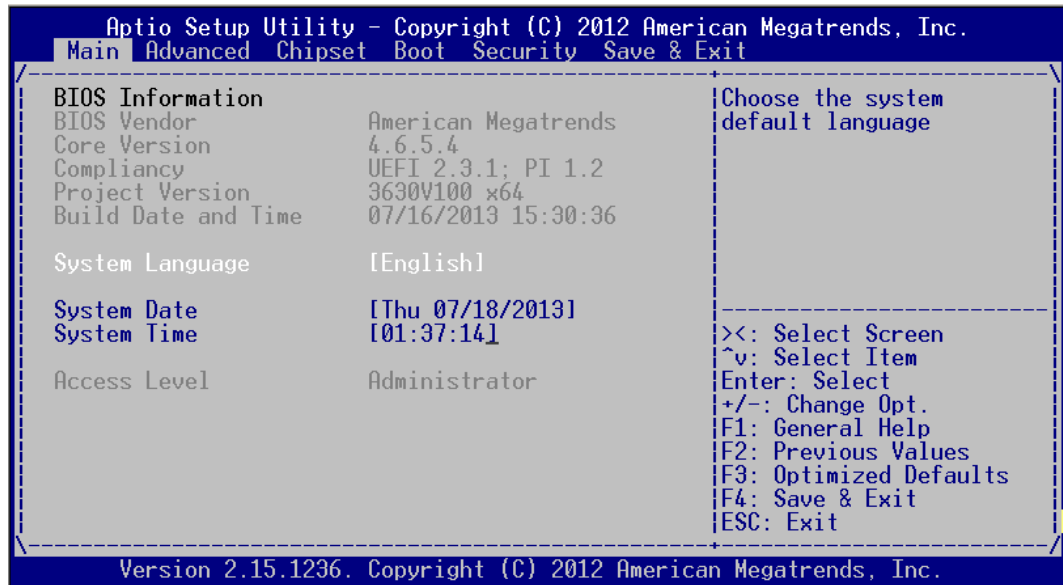

Figure 4.1: Setup Program Initial Screen

AMI's BIOS ROM has a built-in Setup program that allows users to modify the basic system configuration. This type of information is stored in BIOS ROM so it retains the Setup information when the power is turned off.

4.2 Entering Setup

Turn on the computer to enter POST screen, and BIOS and CPU information will be shown. Press and you will immediately be allowed to enter Setup.

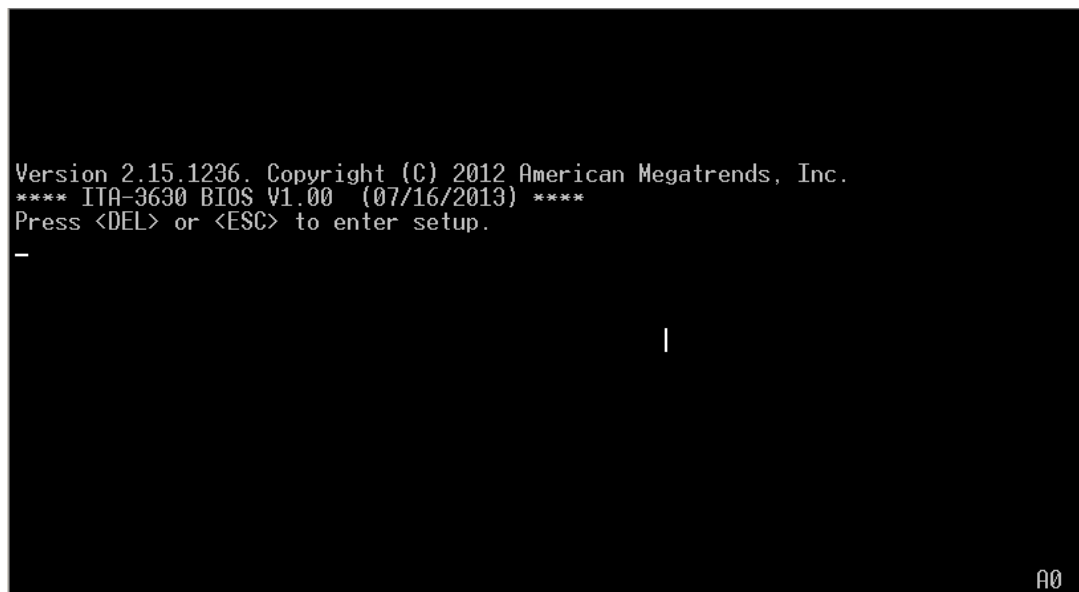

Figure 4.2: POST Screen

4.2.1 Main Setup

When you first enter the BIOS Setup Utility, you will enter the Main setup screen. You can always return to the Main setup screen by selecting the Main tab. There are two Main Setup options. They are described in this section. The Main BIOS Setup screen is shown below.

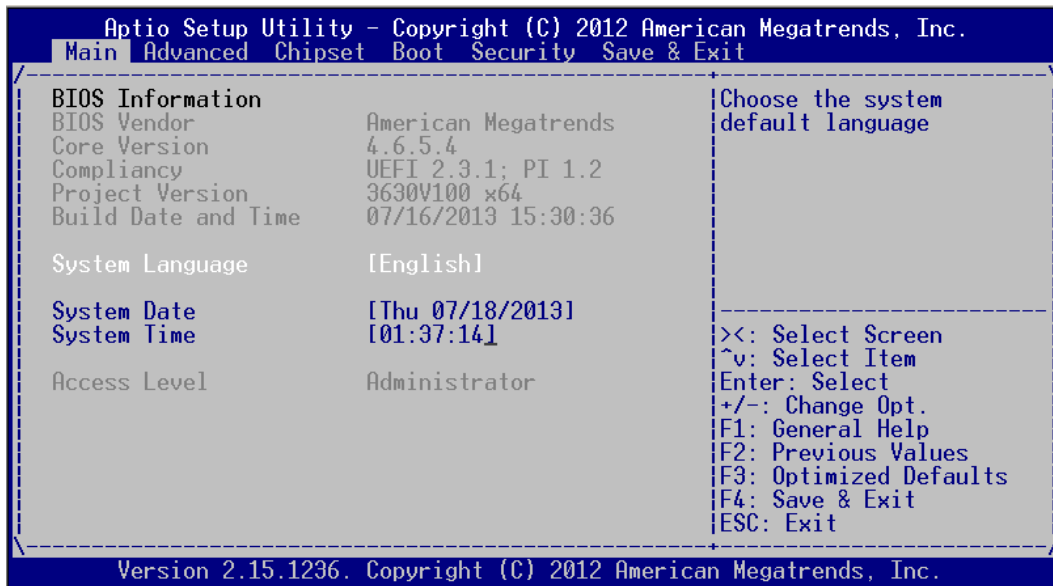

Figure 4.3: Main Setup Screen

The Main BIOS setup screen has two main frames. The left frame displays all the options that can be configured. Grayed-out options cannot be configured; options in blue can. The right frame displays the key legend.

Above the key legend is an area reserved for a text message. When an option is selected in the left frame, it is highlighted in white. Often a text message will accompany it.

■ System Time / System Date

Use this option to change the system time and date. Highlight System Time or System Date using the <Arrow> keys. Enter new values through the keyboard. Press the <Tab> key or the <Arrow> keys to move between fields. The date must be entered in MM/DD/YY format. The time must be entered in HH:MM:SS format.

4.2.2 Advanced BIOS Features Setup

Select the Advanced tab from the ITA-3630 setup screen to enter the Advanced BIOS Setup screen. You can select any of the items in the left frame of the screen, such as CPU Configuration, to go to the sub menu for that item. You can display an Advanced BIOS Setup option by highlighting it using the <Arrow> keys. All Advanced BIOS Setup options are described in this section. The Advanced BIOS Setup screen is shown below. The sub menus are described on the following pages.

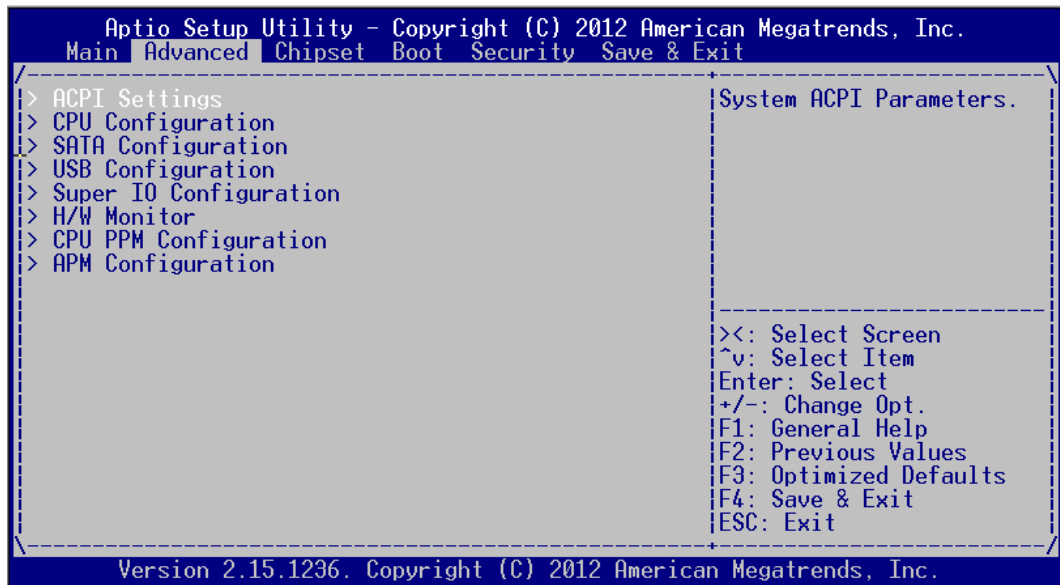

Figure 4.4: Advanced BIOS Features Setup Screen

4.2.2.1 ACPI Configuration

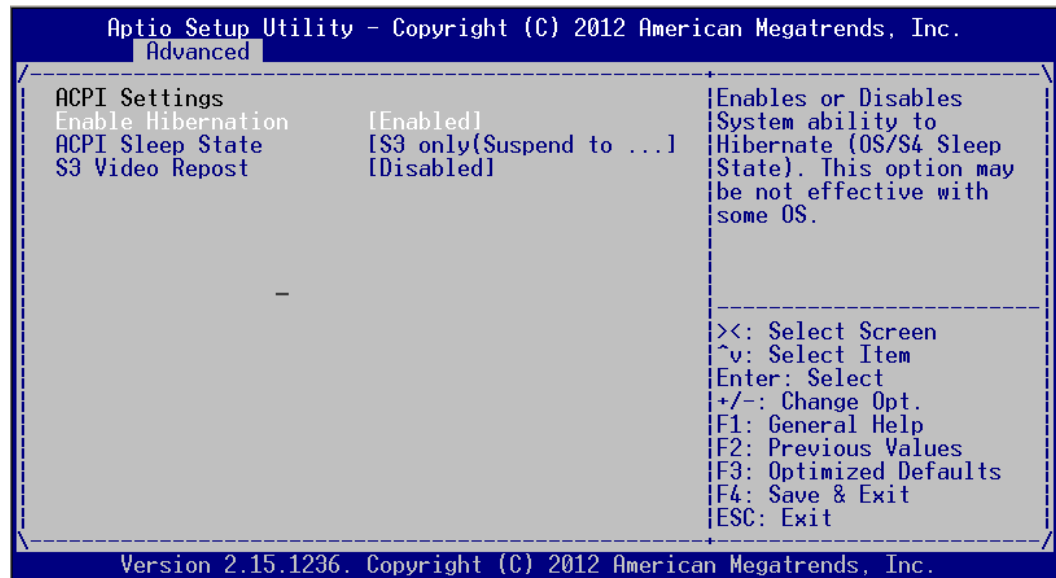

Figure 4.5 ACPI Configuration

- **Enable Hibernation**
This item allows users to enable or disable Hibernation.
- **ACPI Sleep State**
This item allows users to select ACPI state during system hibernation.
- **S3 Video Repost**
This item is used to decide whether to call VBIOS when the system resumes from S3/SRT. The default setting is “Disabled”.

4.2.2.2 CPU Configuration

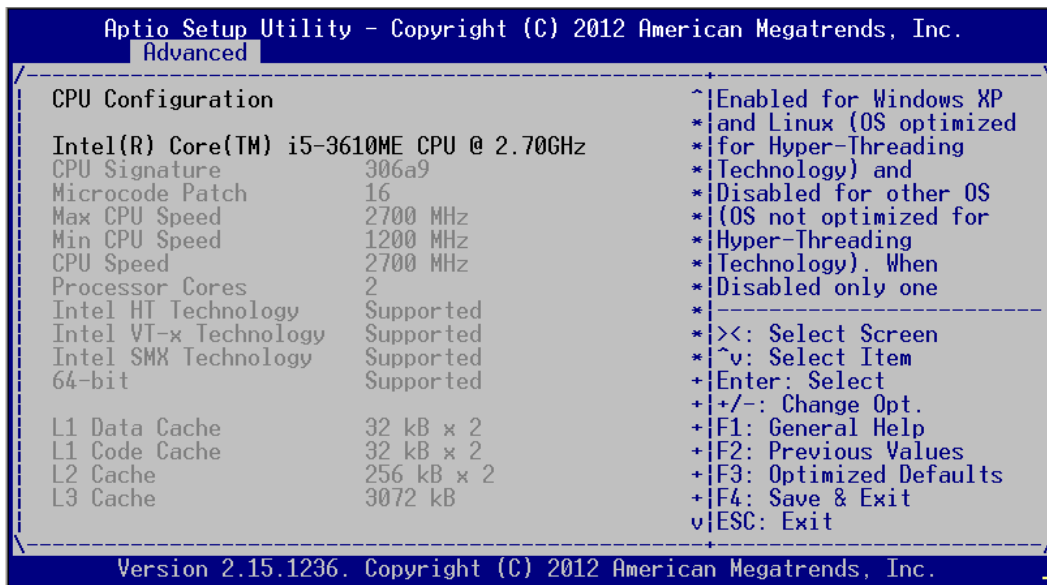

Figure 4.6: CPU Configuration (1)

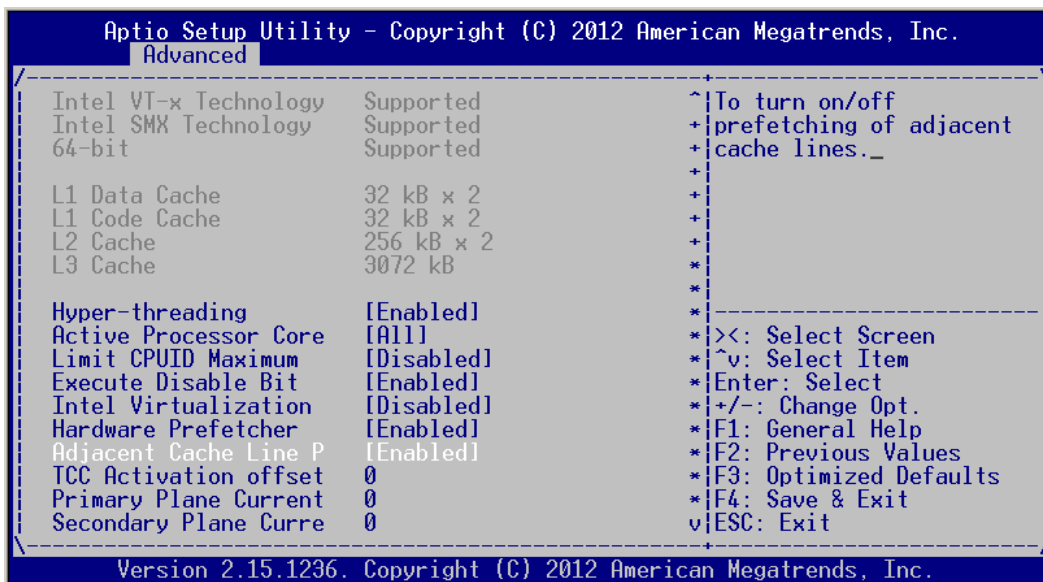

Figure 4.7 CPU Configuration (2)

- **Hyper Threading**
This item allows users to enable or disable Intel Hyper Threading Technology. The default setting is “Enabled”.
- **Active Processor Core**
This item allows users to choose how many processor cores to activate when you are using a dual or quad cores processor. The default setting is “All”.
- **Limit CPUID Maximum**
This item allows users to set the limit value for CPUID. The default setting is “Disabled”.
- **Execute Disable Bit**
This item is a hardware feature introduced by Intel in its new generation CPU. It can help CPU realize self-protection under the circumstance of hostile attack based on buffer overflow, so as to avoid the virus attack, such as blasting wave. The default setting is “Enabled”.

- **Hardware Prefetcher**
This item allows users to enable or disable Hardware Prefetcher Technology. The default setting is “Enabled”.
- **Adjacent Cache Line Prefetch**
This item allows users to enable or disable sequential access to memory. The default setting is “Enabled”.
- **Intel Virtualization Technology**
This item is a system virtualization technology adopted in CPU produced by Intel. It allows multiple operating systems to run simultaneously on the same system. It adopts Vanderpool Technology, which allows multiple systems to run on the same system and applications can run in their own individual space. The default setting is “Enabled”.

4.2.2.3 SATA Configuration

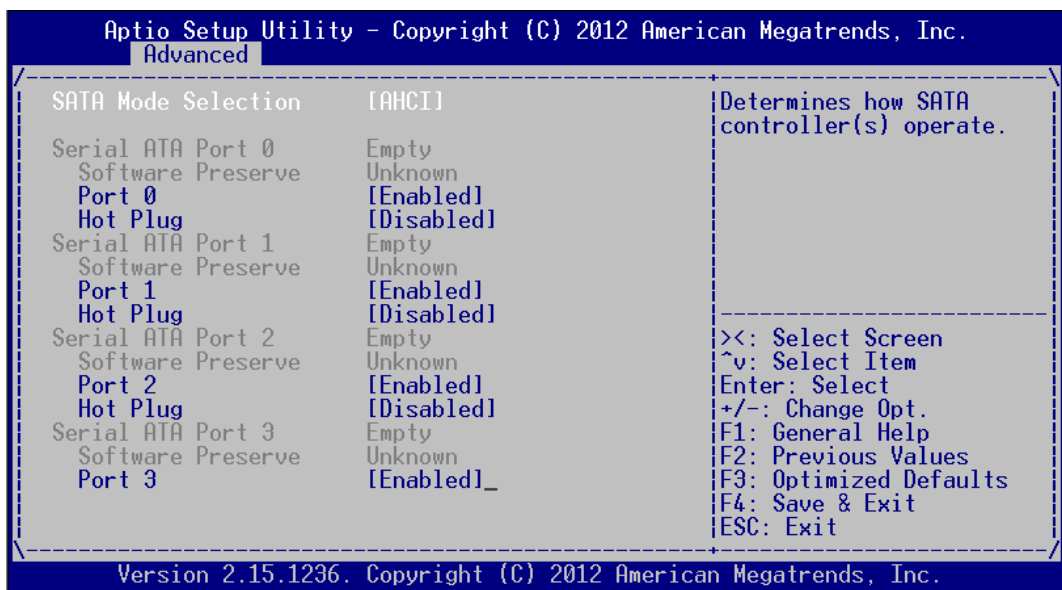

Figure 4.8 SATA Configuration

- **SATA Mode Selection**
This item allows users to select configuration mode of SATA Controller(s). The default setting is “AHCI”.

4.2.2.4 USB Configuration

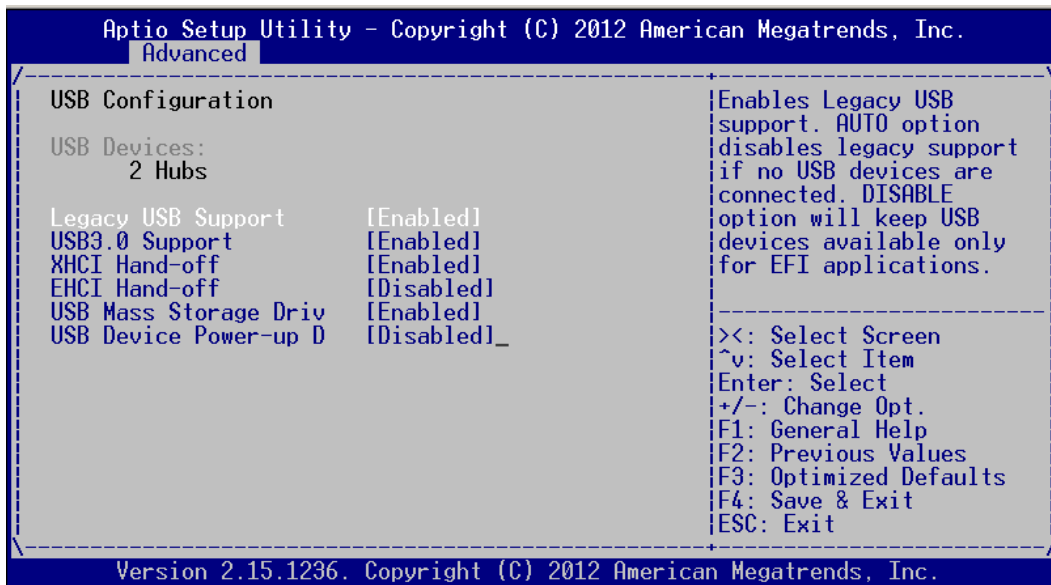

Figure 4.9: USB Configuration

- **Legacy USB Support**

This item allows users to enable support for traditional USB. It will be automatically set as “Disabled” when no USB device is connected. The default setting is “Enabled”.
- **USB 3.0 Support**

This item allows users to enable or disable USB 3.0 (XHCI). The default setting is “Enabled”.
- **XHCI Hand-off**

This item is to enable or disable function of supporting OS without XHCI Hand-off feature. The default setting is “Enabled”.
- **EHCI Hand-off**

This item is to enable or disable function of supporting OS without EHCI Hand-off feature. The default setting is “Disabled”.
- **USB Mass Storage Driver Support**

This item allows users to set the specific type of the connected USB device.
- **USB Device Power-up Delay**

This item allows users to enable or disable the function of USB device reporting max. delay time to host controller. The default setting is “Disabled”.

4.2.2.5 Super I/O Configuration

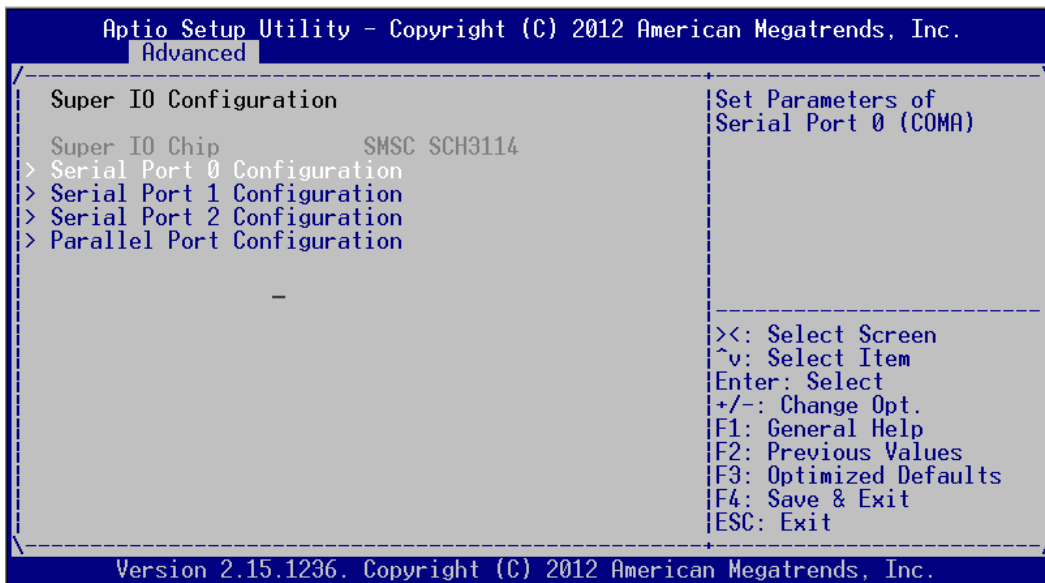

Figure 4.10: Super I/O Configuration

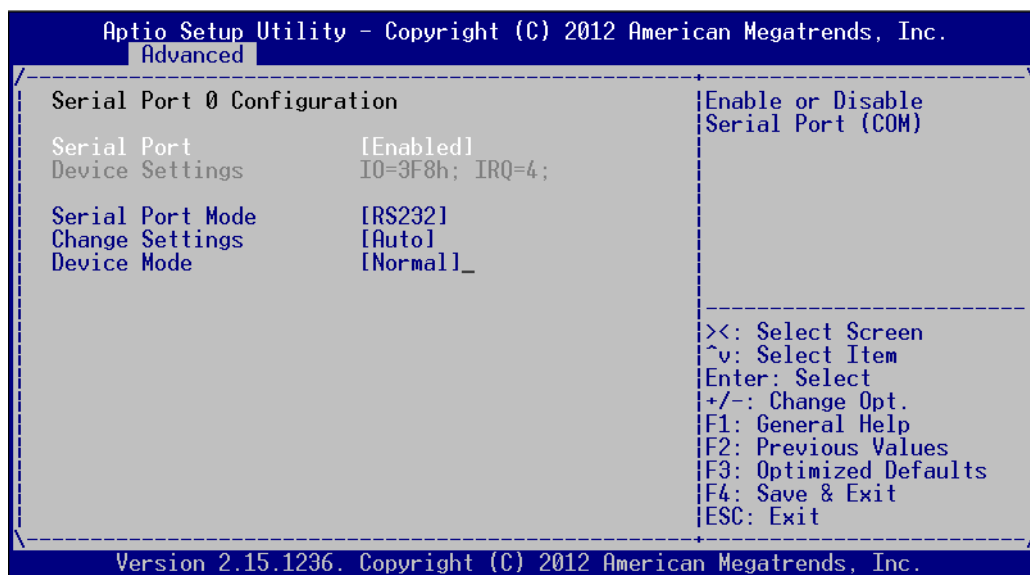

Figure 4.11 Serial Port Configuration

Serial Port 0 Configuration

■ Serial Port

This item allows users to open or close serial port. The default setting is "Enabled".

■ Serial Port Mode

This item allows users to set serial port as RS232/422/485. The default setting is "RS232".

■ Change Settings

IO=3F8h; IRQ=4;

IO=3F8h; IRQ=3,4,5,6,7,10,11,12;

This item allows users to select IO address and IRQ to change serial port settings.

- **Device Mode**

This item allow users to select device mode. The default setting is “Normal Mode”.

4.2.2.6 H/W Monitor

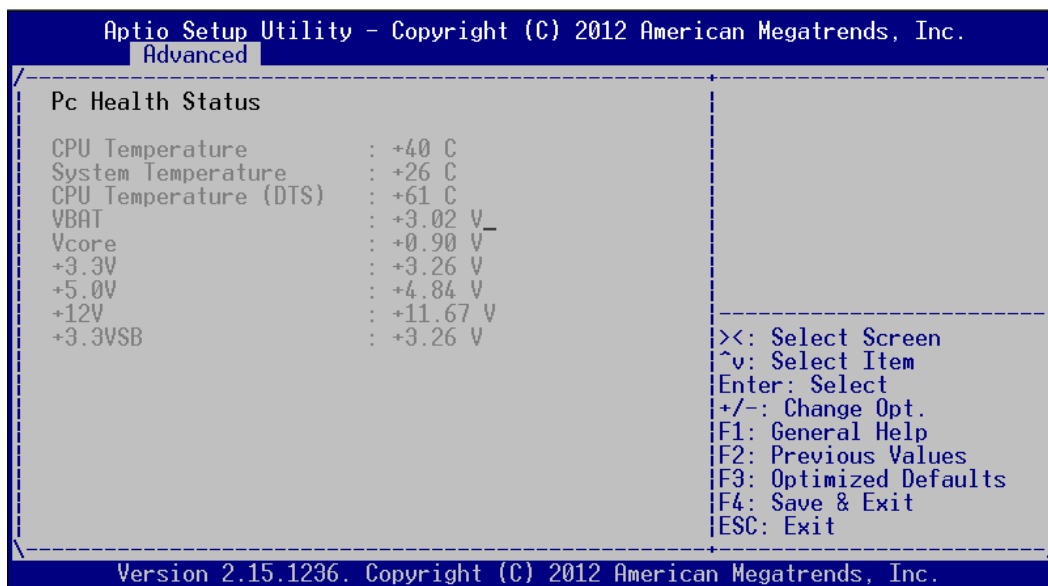

Figure 4.12: H/W Monitor COnfiguration

- **PC Health Status**

This item is used to hardware safety detection. BIOS will display the current system temperature, CPU temperature and other related voltage values. All these parameters have a certain range, so operations out of the range should be avoided.

4.2.2.7 CPU PPM Configuration

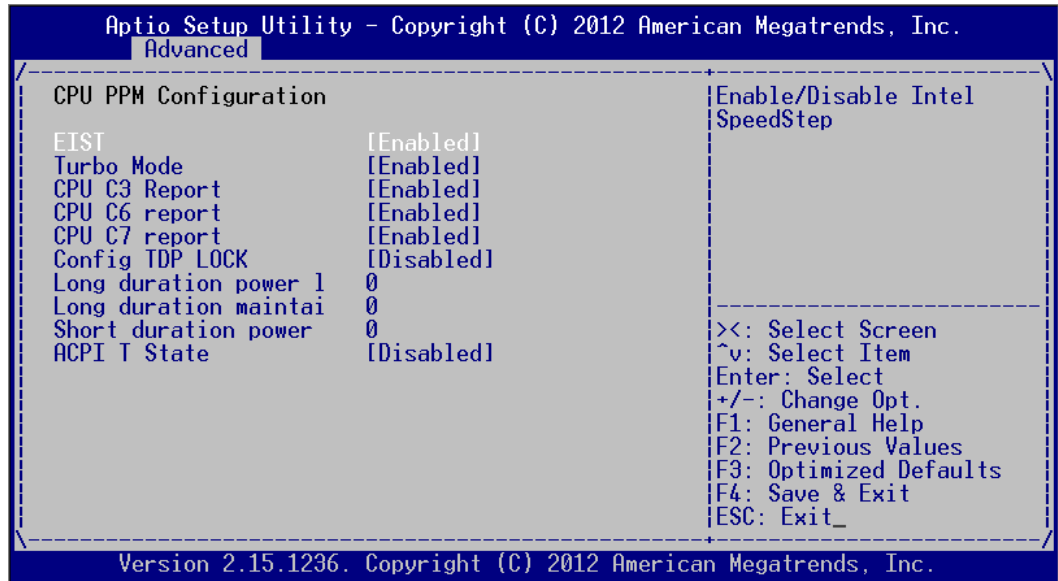

Figure 4.13: CPU PPM Configuration

- **EIST**
This item is used to set CPU SpeedStep function. The default setting is "Enabled".
- **Turbo Mode**
This item is used to set CPU Turbo mode function. The default setting is "Enabled".
- **CPU C3/C6/7 Report**
This item is used to set CPU C-state function. The default setting is "Enabled".
- **Config TDP LOCK**
This item is used to set Config TDP LOCK function. The default setting is "Disabled".
- **ACPI T State**
This item is used to set ACPI T State function. The default setting is "Disabled".

4.2.2.8 APM Configuration

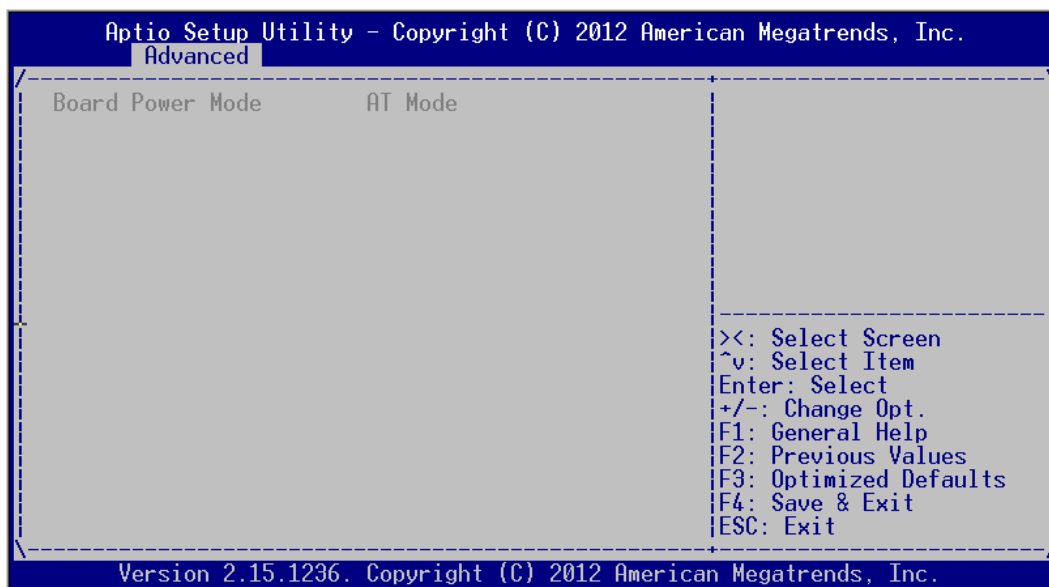

Figure 4.14: APM Configuration

- **Board Power Mode**

This item is used to set power on mode: AT or ATX mode.

4.2.3 Advanced Chipset Features Setup

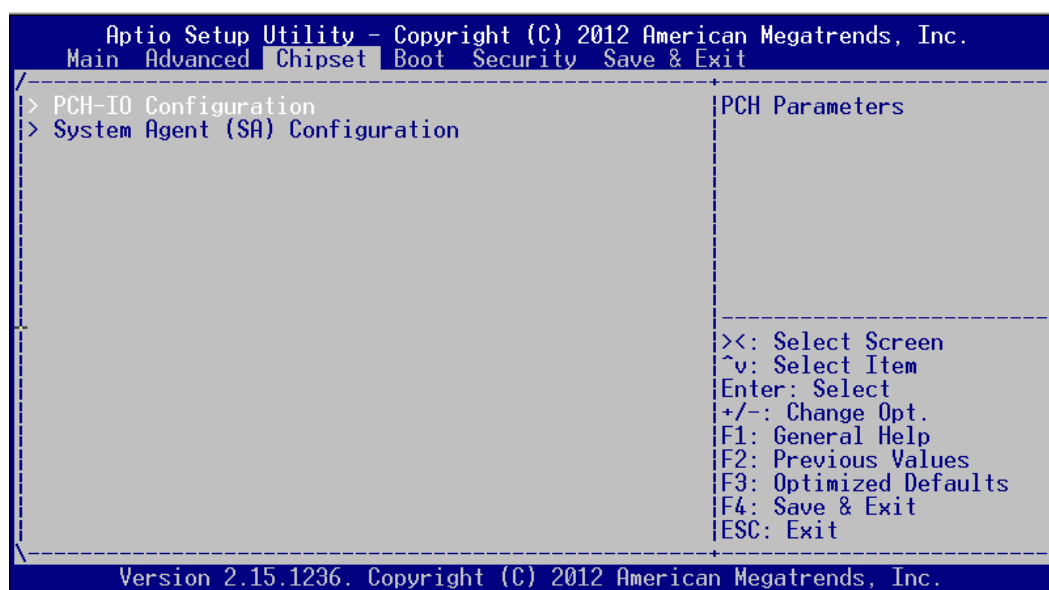

Figure 4.15 Advanced Chipset Features Setup

4.2.3.1 PCH-IO Configuration

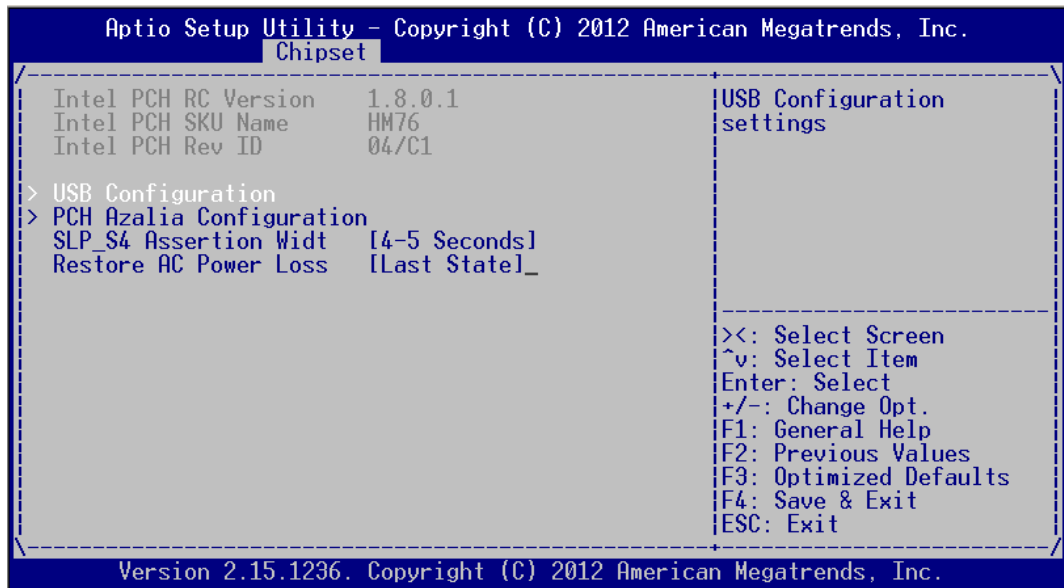

Figure 4.16 PCH-IO Configuration

- **SLP_S4 Assertion Width**
This item is used to set the min. delay of SLP_S4# signal when booting. The default setting is “4-5 Seconds”.
- **Restore AC Power Loss**
This item is used to set power status when the power in on.
Power Off: Power button should be pressed after the power is on.
Power On: No action required after the power is on.
Last State: Resume to the last state before the power is off.
- **USB Configuration**

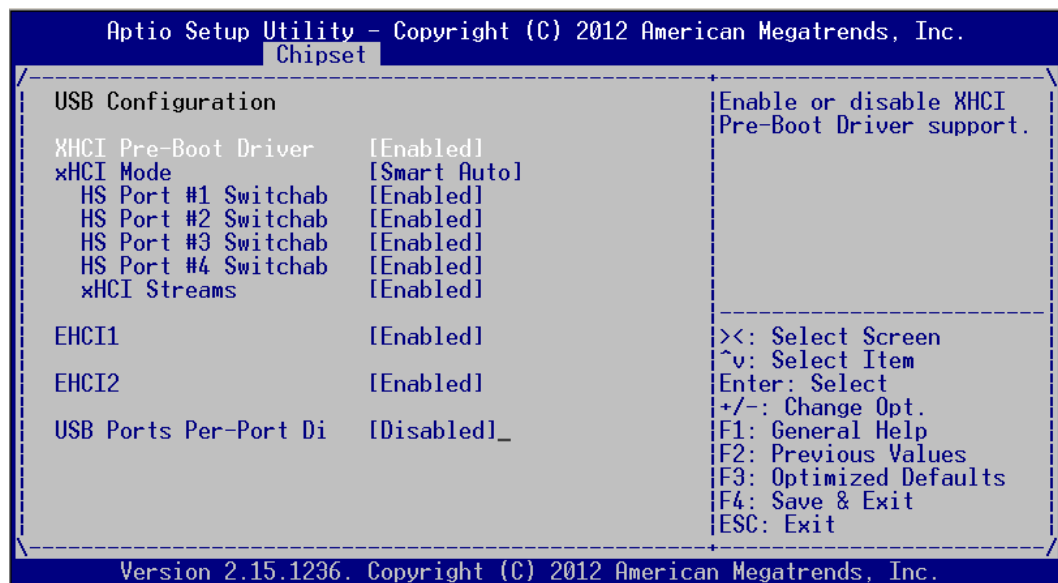

Figure 4.17 Chipset USB Configuration

- XHCI Pre-Boot Driver
This item allows users to enable or disable XHCI Pre-Boot Driver. The default setting is “Enable”.

- xHCI Mode
This item is used to select xHCI controller mode. The default setting is “Smart Auto”.
- HS Port #1/#2/#3/#4 Switchable
Enable: BIOS will let the port connect to EHCI; Disable: BIOS will let the port connect to xHCI. The default setting is “Enable”.
- xHCI Streams
This item allows users to enable or disable xHCI Maximum Primary Stream Array Size.
- EHCI1/EHCI2
This item allows users to enable or disable EHCI #1/EHCI #2. The default setting is “Enable”.
- USB Ports Per-Port Disable Control
This item is used to set disable control of each USB connector.

■ PCH Azalia Configuration

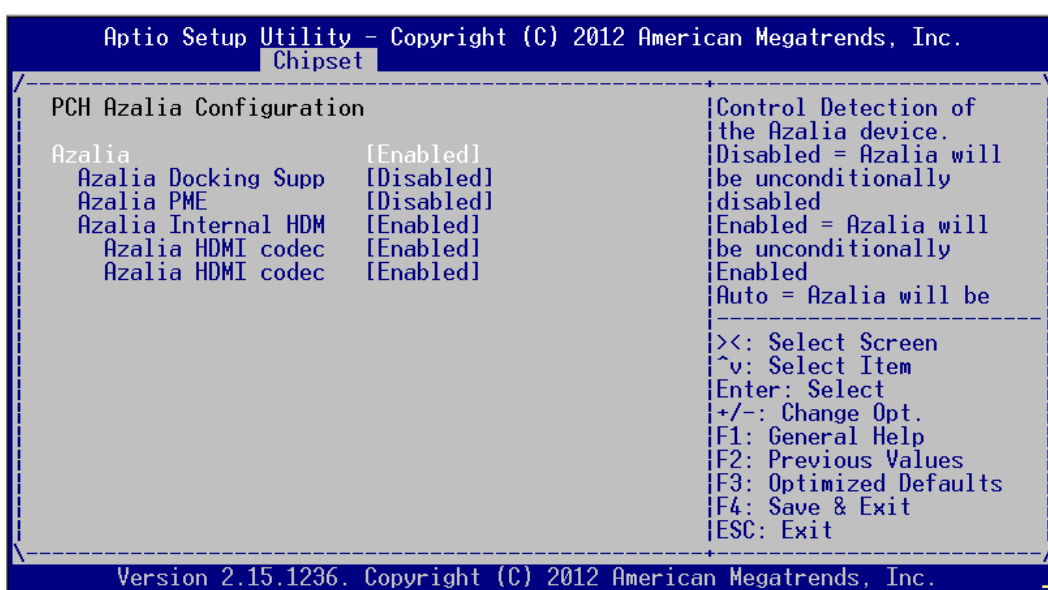

Figure 4.18 PCH Azalia Configuration

- Azalia
This item is used to detect Azalia device. The default setting is “Enable”.
Disabled: Azalia will be unconditionally disabled.
Enabled: Azalia will be unconditionally Enabled.
Auto: Azalia will be enabled if present, disabled otherwise.

4.2.3.2 System Agent (SA) Configuration

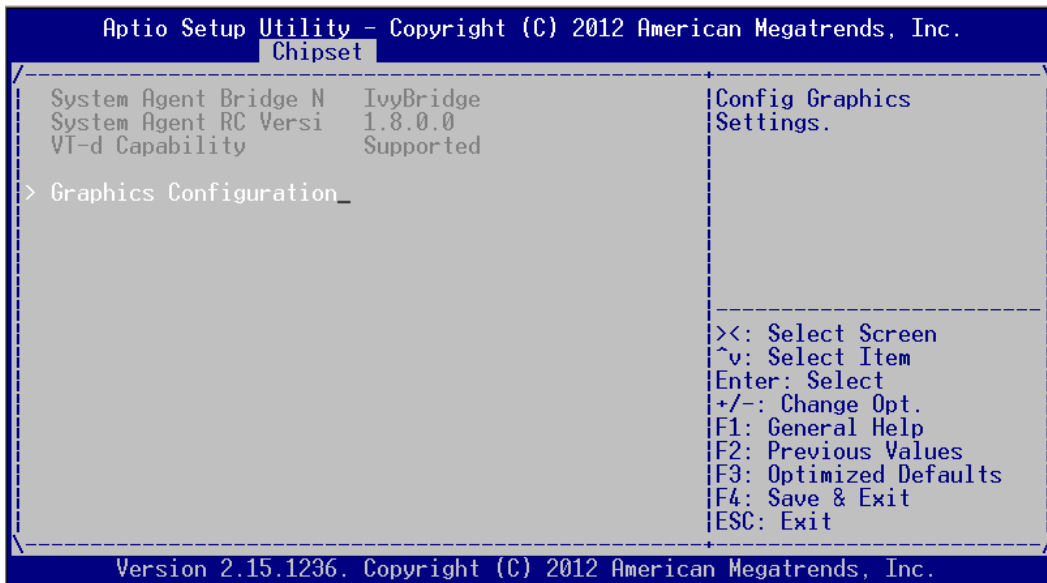

Figure 4.19: System Agent (SA) Configuration

■ Graphics Configuration

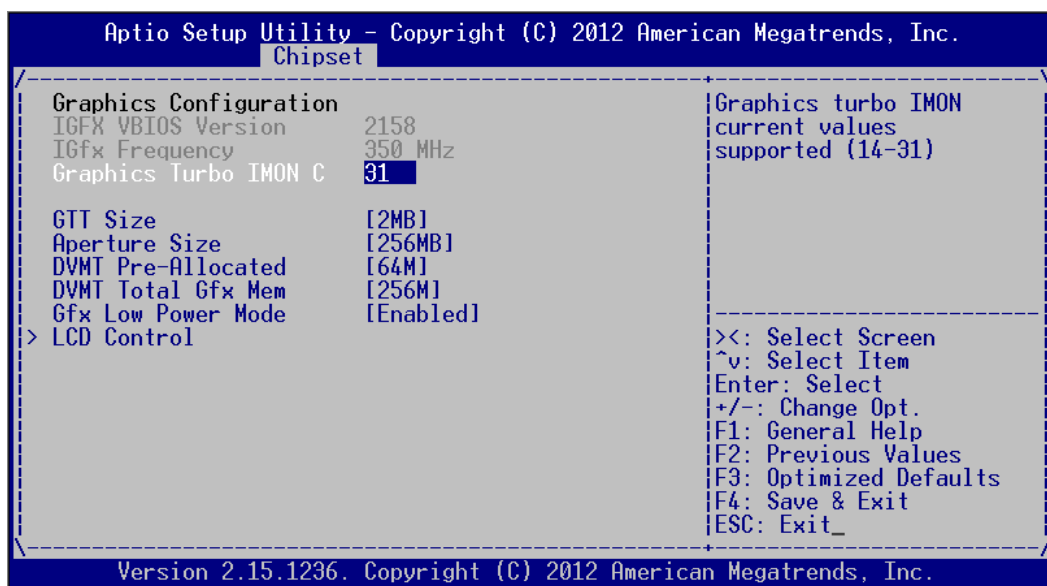

Figure 4.20 Graphics Configuration Menu

- Graphics Turbo IMON Current
Graphics turbo IMON current values supported (14-31).
- GTT Size
This item is used to select GTT size.
- DVMT Total Gfx Mem
This item allows users to select memory size of DVMT Total.
- Gfx Low Power Mode
This item allows users to enable or disable Low Power mode.

■ LCD Control

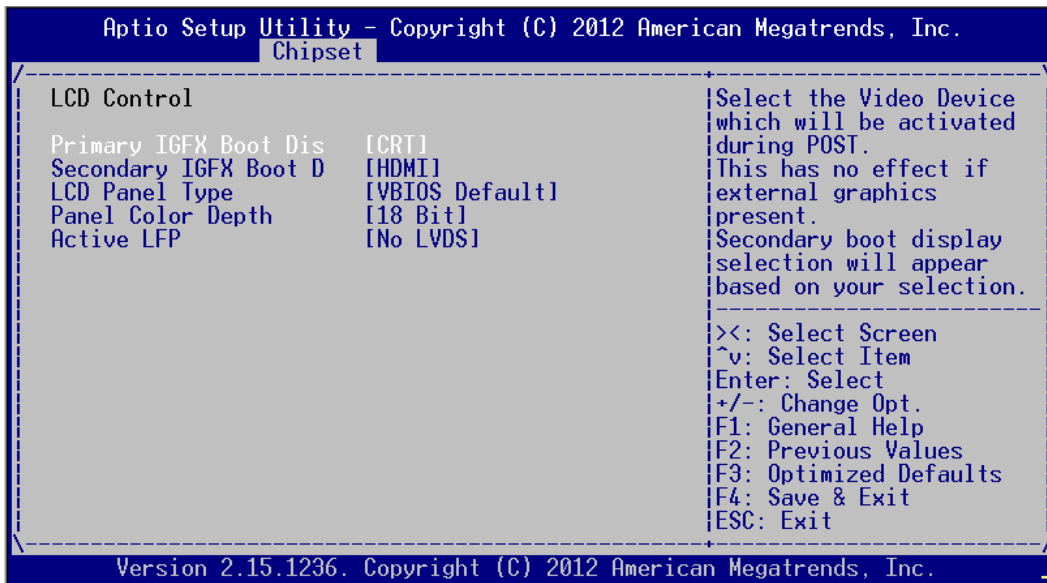

Figure 4.21 LCD Control

- Primary IGFX Boot Display
This item is used to select video device started during POST. The default setting is “CRT”.
- Secondary IGFX Boot Display
This item is used to set Second Display Device.
- LCD Panel Type
This item is used to set LCD resolution. The default setting is “1024x768(24bit)”.
- Panel Color Depth
This item is used to set LFP Panel Color Depth.
- Active LFP
This item is used to select Active LFP Configuration.

4.2.4 Boot Setup

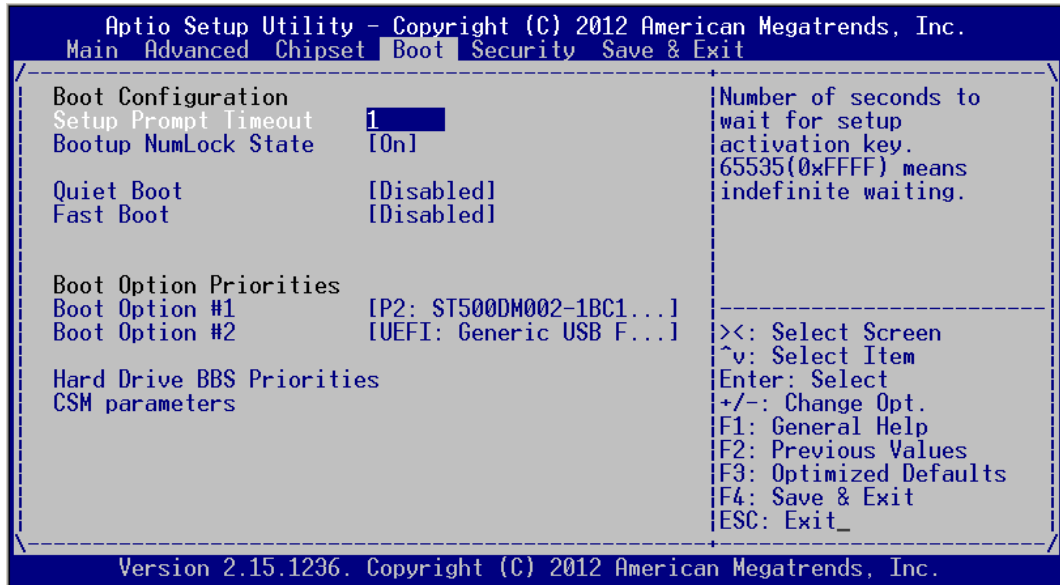

Figure 4.22: Boot Setup

4.2.4.1 Boot Configuration

- **Setup Prompt Timeout**

This item is the waiting time of pressing Setup button. If Setup button is not pressed within the setting time, system will continue to boot.
- **Bootup NumLock State**

This item allows users to active Bootup NumLock State function after the system is power on to DOS. The default setting is “On”.

On: NumLock function is on when system boots.

Off: Cursor control is activated for keypad when system boots.
- **Quiet Boot**

If it is set to “Disabled”, BIOS will display normal POST information; If it is set to “Enabled”, BIOS will show OEM icon rather than POST information.
- **Fast Boot**

This item allows BIOS to skip some testing procedures during booting so as to reduce system boot-up time. The default setting is “Disabled”.

4.2.4.2 Boot Option Priorities

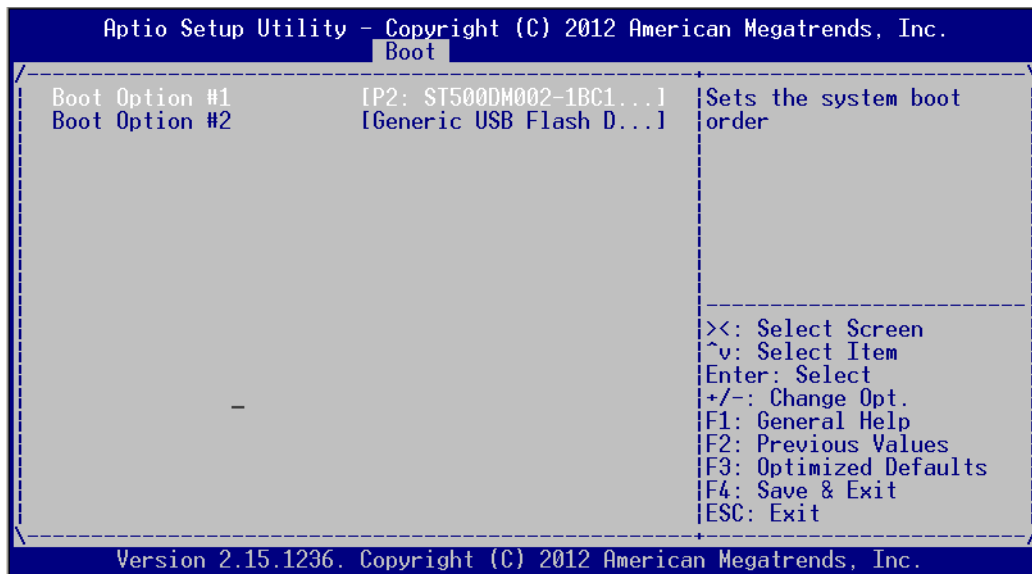

Figure 4.23 Boot Option Priorities

This item is used to set device boot sequence.

4.2.4.3 CSM Parameter

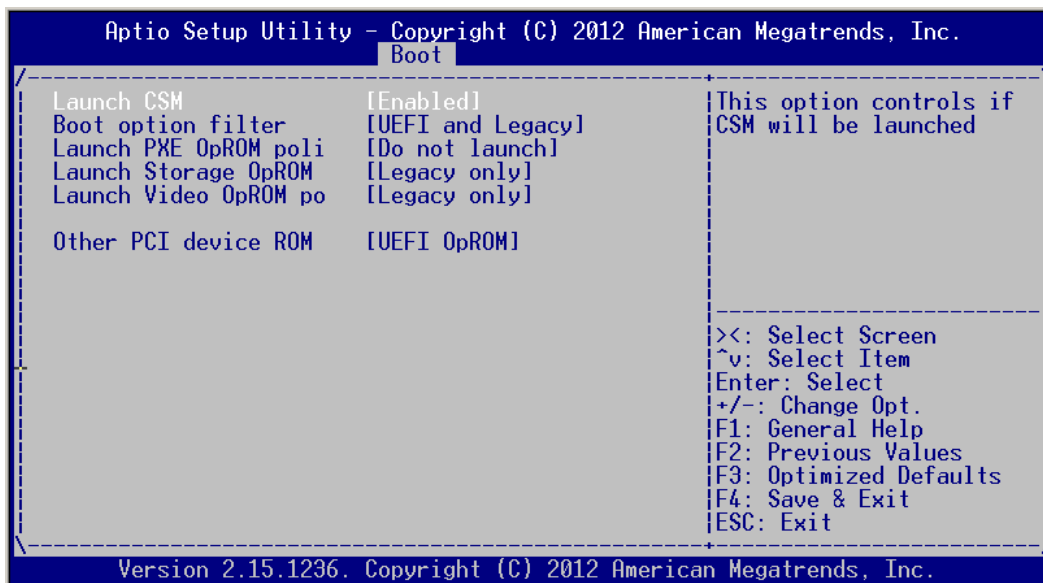

Figure 4.24: CSM Parameter

- **Launch CSM**
This item allows user to enable or disable CSM. The default setting is “Enable”.
- **Boot option filter**
This item is used to control boot device system. The default setting is “UEFI and Legacy”.
- **Launch PXE OpROM policy**
This item is used to control UEFI execution and backward compatibility of PXE OpROM. The default setting is “Do not Launch”.
- **Launch Storage OpROM policy**
This item is used to control UEFI execution and backward compatibility of PXE OpROM. The default setting is “Legacy only”.

- **Launch Video OpROM policy**
This item is used to control UEFI execution and backward compatibility of PXE OpROM. The default setting is “Legacy only”.
- **Other PCI device ROM priority**
This item is used for PCI device that is not the same as network, which is defined by massive storage or video booted by OpROM.

4.2.5 Security Setup



Figure 4.25: Setup Security Menu

- **Administrator Password**
This item is used to set Administrator Password.
- **User Password**
This item is used to set User Password.

4.2.6 Save & Exit Setup

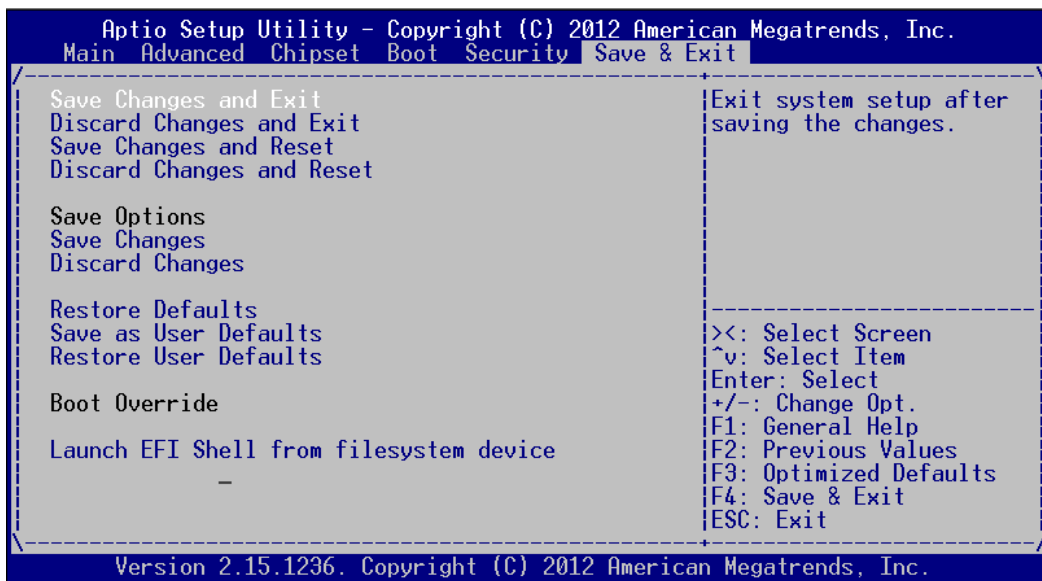

Figure 4.26: Setup Save & Exit Menu

- **Save Changes and Exit**

When you have completed system configuration, select this option to save your changes, exit BIOS setup and reboot the computer so the new system configuration parameters can take effect.

 1. Select Save Changes and Exit from the Exit menu and press <Enter>. The following message appears:
Save Configuration Changes and Exit Now?
[Ok] [Cancel]
 2. Select Ok or Cancel.
- **Discard Changes and Exit**

Select this option to quit Setup without making any permanent changes to the system configuration.

 1. Select Exit Discard Changes and Exit from the Exit menu and press <Enter>. The following message appears:
Discard Changes and Exit Setup Now?
[Ok] [Cancel]
 2. Select Ok to discard changes and exit.
- **Save Changes and Reset**

When you have completed system configuration, select this option to save your changes, exit BIOS setup and reboot the computer so the new system configuration parameters can take effect.

 1. Select Save Changes and Reset and press <Enter>. The following message appears:
Save configuration and Reset?
[Yes] [No]
 2. Select Ok or Cancel.

-
- **Discard Changes and Reset**
Select this option to quit Setup without making any permanent changes to the system configuration.
 1. Select Discard Changes and Reset from the Exit menu and press <Enter>. The following message appears:
Discard Changes and Reset Setup Now?
[Ok] [Cancel]
 2. Select Ok to discard changes and exit.
 - **Save Changes**
This item allows users to save changes done so far to any of the options.
 - **Discard Changes**
This item allows users to discard changes done so far to any of the options.
 - **Restore Defaults**
This item allows users to restore/load default values for all the options.
 - **Save as User Defaults**
This item allows users to save the changes done so far as user defaults.
 - **Restore User Defaults**
This item allows users to restore the user defaults to all the options.
 - **Boot Override**
This item allows users to set boot device.
 - **Launch EFI Shell from filesystem device**
This item allows to boot EFI shell from system file device.

Chapter 5

Driver Installation

Sections include:

- Chipset Windows Driver Setup
- VGA Windows Driver Setup
- ME Windows Driver Setup
- LAN Windows Driver Setup
- USB 3.0 Windows Driver Setup
- Audio Windows Driver Setup

5.1 Introduction

Advantech offers a complete range of Device Driver and software supports for Windows programming developers. You can apply the Windows Device Drivers to the most popular Windows Programming tools, such as Visual C++, Visual Basic, Borland C++ Builder and Borland Delphi.

Here Windows 7 is taken as an example.

5.2 Driver Installation

Insert the driver CD into your system's CD-ROM drive. You can see the ITA-3630 driver folder items.

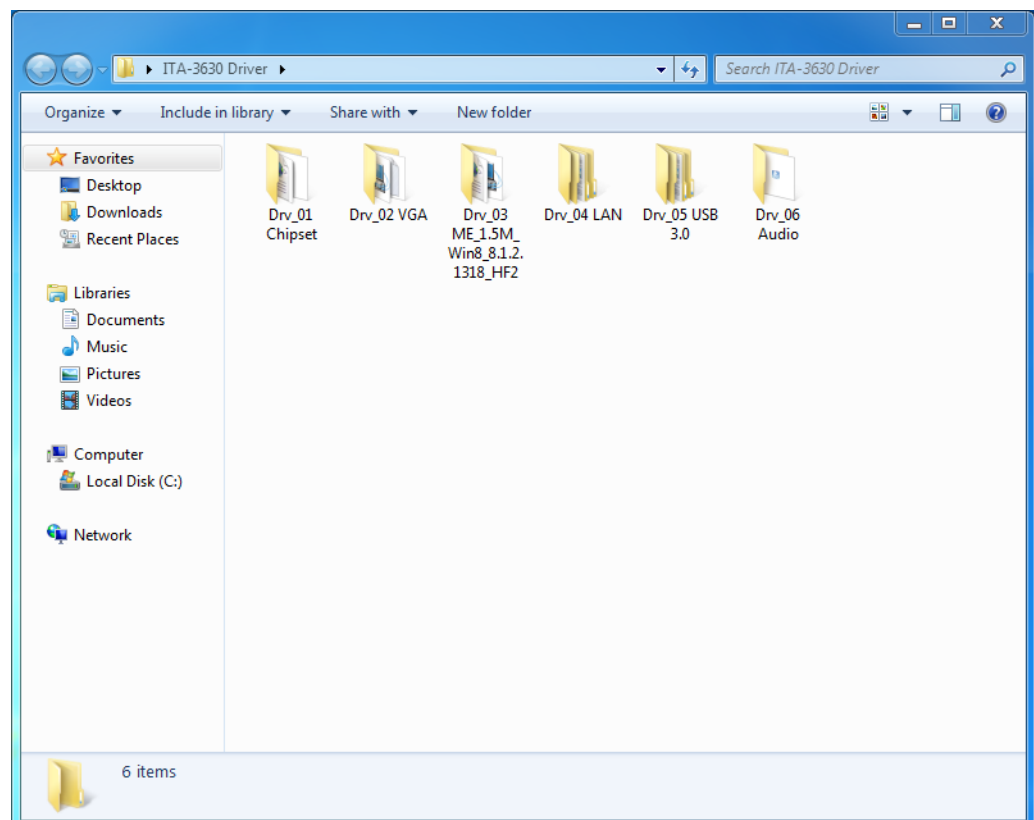

5.2.1 Chipset Windows Driver Setup

Insert the driver CD into your system's CD-ROM drive. You can see the driver folder items. Navigate to the "Drv_01Chipset" folder and click "Setup" to complete the installation of the driver.

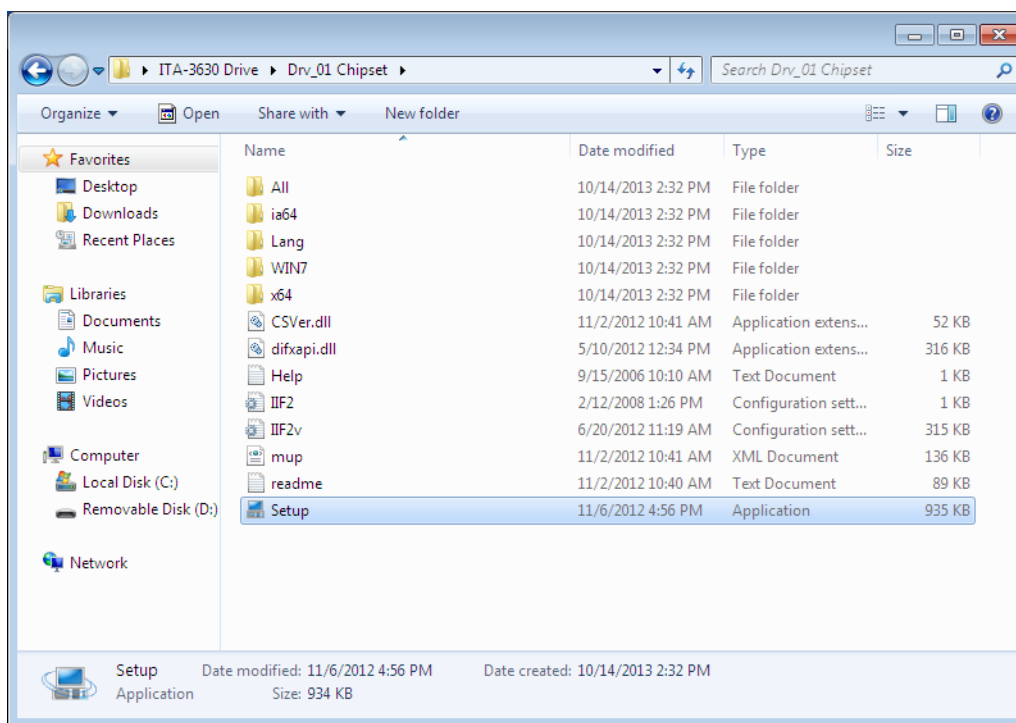

5.2.2 VGA Windows Driver Setup

Insert the driver CD into your system's CD-ROM drive. You can see the driver folders items. Navigate to the "Drv_02VGA" folder and click "Setup" to complete the installation of the drivers.

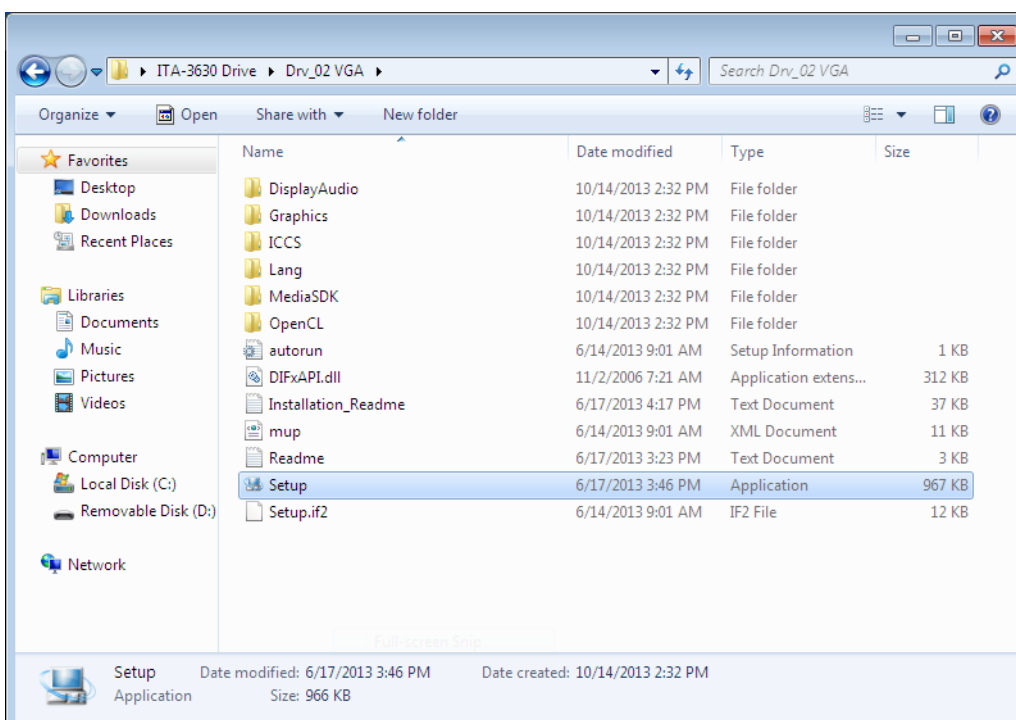

5.2.3 ME Windows Driver Setup

Insert the driver CD into your system's CD-ROM drive. You can see the driver folders items. Navigate to the "Drv_03ME" folder and click "Setup" to complete the installation of the drivers.

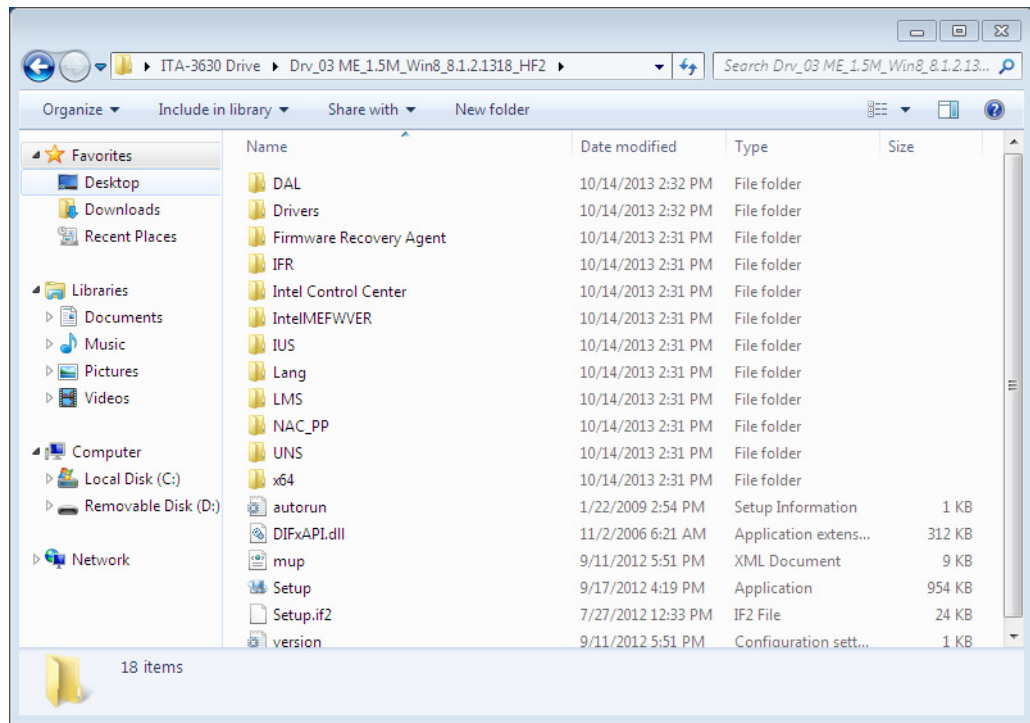

5.2.4 LAN Windows Driver Setup

Insert the driver CD into your system's CD-ROM drive. You can see the driver folders items. Navigate to the "Drv_04LAN" folder and click "Autorun" to complete the installation of the drivers.

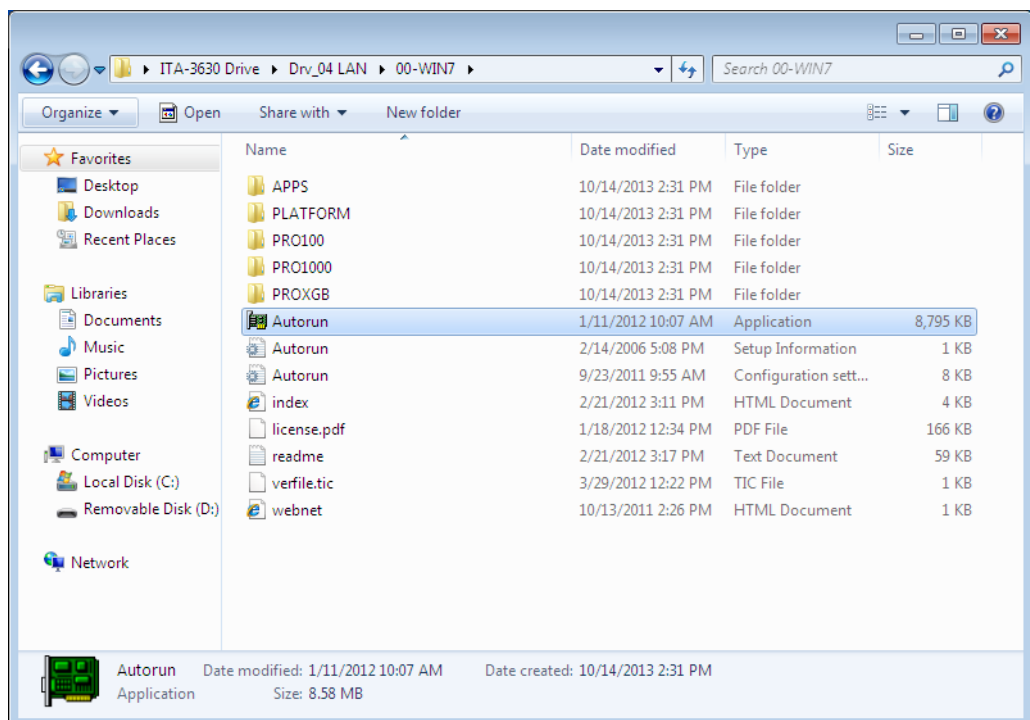

5.2.5 USB 3.0 Windows Driver Setup

Insert the driver CD into your system's CD-ROM drive. You can see the driver folders items. Navigate to the "Drv_05USB3.0" folder, and click "Setup" to complete the installation of the drivers.

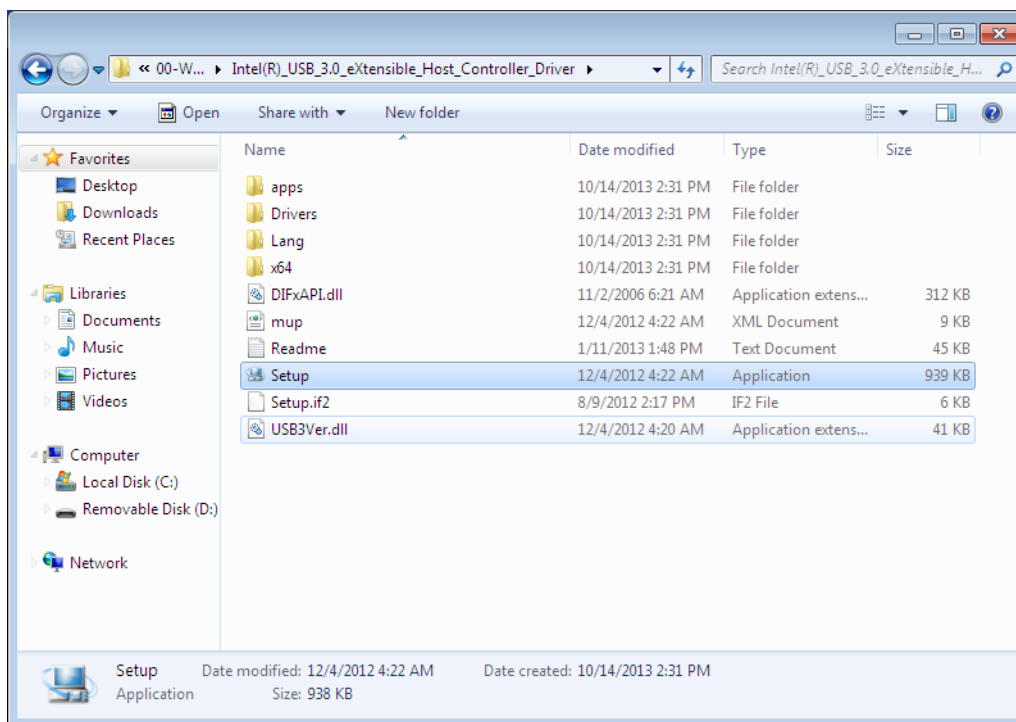

5.2.6 Audio Windows Driver Installation

Insert the driver CD into your system's CD-ROM drive. You can see the driver folders items. Navigate to the "Drv_06AUDIO" folder and click "WDM_R264.exe" to complete the installation of the drivers.

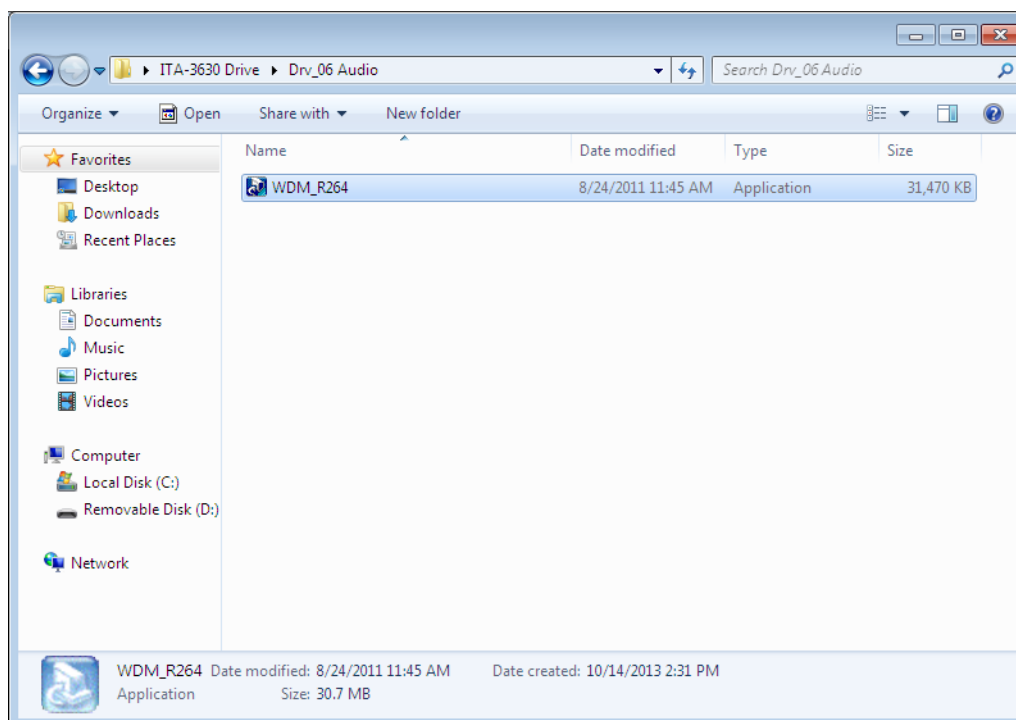

Chapter 6

GPIO Programming Guide

This chapter introduces GPIO programming Guide.

Please carefully read and study the below screenshots and source codes in blue.
Please download specification of NXP Semiconductors PCA955 for programming.

6.1 ITA-3630 Digital DIO Definition

See Section 2.3.6.

6.2 Configuration Sequence

ITA-3630's GPIO is realized through PCA9554 GPIO IC connected to ICH SMBUS. Therefore, the configuration and access to GPIO IC is completed by IO Space accessing to ICH SMBUS controller.

Below is the diagram of ICH SMBUS IO Space:

SMB_BASE + Offset	Mnemonic	Register Name	Default	Type
00h	HST_STS	Host Status	00h	R/WC, RO, R/WC (special)
02h	HST_CNT	Host Control	00h	R/W, WO
03h	HST_CMD	Host Command	00h	R/W
04h	XMIT_SLVA	Transmit Slave Address	00h	R/W
05h	HST_D0	Host Data 0	00h	R/W
06h	HST_D1	Host Data 1	00h	R/W

For ITA-3630, IO address of the above SMB_BASE is 0xF040.

The detailed SMBUS IO control access code, please refer to Chapter 3.

The corresponding SMBUS slave address of PCA9554 of GPIO 00 - GPIO 07 on ITA-3630 is 0x40 (8bit address):

GPIO 00 – GPIO 07: PCA9554 0x40 (IO0 – IO7)

Below is the sketch of PCA9554:

Table 2. Pin description

Symbol	Pin			Description
	DIP16, SO16, SSOP16, TSSOP16	HVQFN16	SSOP20	
A0	1	15	6	address input 0
A1	2	16	7	address input 1
A2	3	1	9	address input 2
IO0	4	2	10	input/output 0
IO1	5	3	11	input/output 1
IO2	6	4	12	input/output 2
IO3	7	5	14	input/output 3
V _{SS}	8	6	15	supply ground
IO4	9	7	16	input/output 4
IO5	10	8	17	input/output 5
IO6	11	9	19	input/output 6
IO7	12	10	20	input/output 7
INT	13	11	1	interrupt output (open-drain)

Below is the diagram of PCA9554 register:

6.1.1 Command byte

Table 3. Command byte

Command	Protocol	Function
0	read byte	Input Port register
1	read/write byte	Output Port register
2	read/write byte	Polarity Inversion register
3	read/write byte	Configuration register

The command byte is the first byte to follow the address byte during a write transmission. It is used as a pointer to determine which of the following registers will be written or read.

PCA9554 has in all 4 registers to control GPIO.

PCA9554 register 0:

6.1.2 Register 0 - Input Port register

This register is a read-only port. It reflects the incoming logic levels of the pins, regardless of whether the pin is defined as an input or an output by Register 3. Writes to this register have no effect.

The default 'X' is determined by the externally applied logic level, normally '1' when no external signal externally applied because of the internal pull-up resistors.

Table 4. Register 0 - Input Port register bit description

Bit	Symbol	Access	Value	Description
7	I7	read only	X	determined by externally applied logic level
6	I6	read only	X	
5	I5	read only	X	
4	I4	read only	X	
3	I3	read only	X	
2	I2	read only	X	
1	I1	read only	X	
0	I0	read only	X	

If one GPIO Pin is set to Input, you can read input value from the bit that register 0 corresponds to.

PCA9554 register 1:

6.1.3 Register 1 - Output Port register

This register reflects the outgoing logic levels of the pins defined as outputs by Register 3. Bit values in this register have no effect on pins defined as inputs. Reads from this register return the value that is in the flip-flop controlling the output selection, **not** the actual pin value.

Table 5. Register 1 - Output Port register bit description

*Legend: * default value.*

Bit	Symbol	Access	Value	Description
7	O7	R	1*	reflects outgoing logic levels of pins defined as outputs by Register 3
6	O6	R	1*	
5	O5	R	1*	
4	O4	R	1*	
3	O3	R	1*	
2	O2	R	1*	
1	O1	R	1*	
0	O0	R	1*	

If one GPIO Pin is set to Output, you can read input value from the bit that register 1 corresponds to.

PCA9554 register 2:**6.1.4 Register 2 - Polarity Inversion register**

This register allows the user to invert the polarity of the Input Port register data. If a bit in this register is set (written with '1'), the corresponding Input Port data is inverted. If a bit in this register is cleared (written with a '0'), the Input Port data polarity is retained.

Table 6. Register 2 - Polarity Inversion register bit description

Legend: * default value.

Bit	Symbol	Access	Value	Description
7	N7	R/W	0*	inverts polarity of Input Port register data
6	N6	R/W	0*	0 = Input Port register data retained (default value)
5	N5	R/W	0*	1 = Input Port register data inverted
4	N4	R/W	0*	
3	N3	R/W	0*	
2	N2	R/W	0*	
1	N1	R/W	0*	
0	N0	R/W	0*	

If one GPIO Pin is set to Input, you can control the polarity of input pin from the bit that register 2 corresponds to.

PCA9554 register 3:**6.1.5 Register 3 - Configuration register**

This register configures the directions of the I/O pins. If a bit in this register is set, the corresponding port pin is enabled as an input with high-impedance output driver. If a bit in this register is cleared, the corresponding port pin is enabled as an output. At reset, the I/Os are configured as inputs with a weak pull-up to V_{DD} .

Table 7. Register 3 - Configuration register bit description

Legend: * default value.

Bit	Symbol	Access	Value	Description
7	C7	R/W	1*	configures the directions of the I/O pins
6	C6	R/W	1*	0 = corresponding port pin enabled as an output
5	C5	R/W	1*	1 = corresponding port pin configured as input (default value)
4	C4	R/W	1*	
3	C3	R/W	1*	
2	C2	R/W	1*	
1	C1	R/W	1*	
0	C0	R/W	1*	

Register 3 is used to set each GPIO as Input or Output:

- If the bit is '0', the corresponding GPIO pin is set as Output;
- If the bit is '1', the corresponding GPIO pin is set as Input.

Example:

Here take ITA-3630 as an example. Assume GPIO 00 is set as Output and GPIO 7 is set as Input, with two pins interconnected, how to set the corresponding register?

GPIO 00 corresponds to PCA9554 0x40 IO0, while GPIO 07 corresponds to PCA9554 0x40 IO7.

Set GPIO 00 as Output:

1. Read SMBUS slave 0x40 register 3 byte value;
2. Set bit 0 of the value read in step 1 as 0 and write it to SMBUS slave 0x40 register 3;
3. Read SMBUS slave 0x40 register 1 byte value;
4. Set bit 0 of the value read in step 3 as 0 or 1 according to low or high of the output value, then write it back to SMBUS slave 0x40 register 1.

Set GPIO 07 as Input:

1. Read SMBUS slave 0x40 register 3 byte value;
2. Set bit 7 of the value read in step 1 as 1 and write it to SMBUS slave 0x40 register 3;
3. Read SMBUS slave 0x40 register 0 byte value;
4. Decide low or high of the input value through bit7 value read in step3.

6.3 Function Call for Reference

ICH SMBUS Access Code

(The following code is realized by simulating the access of BIOS to SMBUS. It uses Borand C++ 3.1 for compiling and is successfully tested under DOS (So far, it is not tested under other OSs).

```
#define SMBUS_PORT 0xF040//SMB_BASE?0xF040
```

```
typedef unsigned char BYTE;
```

```
////////////////////////////////////
```

```
BYTE smbush_read_byte(BYTE addr, BYTE offset)
```

```
// Read SMBUS Register byte value. Read one byte value each time. addr is slave address (such as 0x40), and offset is register offset.
```

```
{
```

```
    int i;
```

```
    BYTE data;
```

```
    outportb(SMBUS_PORT + 4, (addr | 1));// Write slave address to SMB_BASE + 4 (When reading, bit 0 of slave address should be set as 1, so here addr|1 is available)
```

```
    newiodelay();//delay
```

```
    newiodelay();//delay
```

```
    chk_smbush_ready();// Whether SMBUS is ready
```

```
    outportb(SMBUS_PORT + 3, offset);// Write register offset to SMB_BASE +
```

```
3
```



```

newiodelay();//delay
newiodelay();//delay

    outportb(SMBUS_PORT + 2, 0x48);// Write SMBUS command to
SMB_BASE + 2. 0x48 means starting byte data transmission
    newiodelay();//delay
    newiodelay();//delay

    for (i = 0; i <= 0x100; i++)
    {
        newiodelay();//longer delay
    }

    chk_smbus_ready();//Whether SMBUS is ready
    return(inportb(SMBUS_PORT + 5));// Byte value read from SMB_BASE + 5
}

////////////////////////////////////
void    smbush_write_byte(BYTE addr, BYTE offset, BYTE value)
// Write SMBUS Register byte value. Write one byte value each time. addr is slave
address (such as 0x40), and offset is register offset.
{
    int    i;

    outportb(SMBUS_PORT + 4, addr);// Write slave address to SMB_BASE +
4 (When writing, slave address bit 0 should be set as 0)
    moredelay();//longer delay
    moredelay();//longer delay

    chk_smbus_ready();//Whether SMBUS is ready

    outportb(SMBUS_PORT + 3, offset);// Write register offset to SMB_BASE +
3
    moredelay();//longer delay
    moredelay();//longer delay

    outportb(SMBUS_PORT + 5, value);//Write data value to SMB_BASE + 5
    moredelay();//longer delay
    moredelay();//longer delay

    outportb(SMBUS_PORT + 2, 0x48);// Write SMBUS command to
SMB_BASE + 2.. 0x48 means starting byte data transmission.
    moredelay();//longer delay
    moredelay();//longer delay

    for (i = 0; i <= 0x100; i++)

```

```

    {
        newiodelay();//longer delay
    }

    chk_smbus_ready();//Whether SMBUS is ready
}

////////////////////////////////////////////////////////////////////////////////////////////////////////////////////////////////
int    chk_smbus_ready()
//To decide whether SMBUS is ready or has completed the action, you should wait for
//a long time to check whether SMBUS has successfully transmitted the command.
//Since error may rarely occurs, BIOS code does not make judgement on the return
//value of this function in read and write of SMBUS byte.
{
    int    i, result = 1;
    BYTE data;

    for (i = 0; i <= 0x800; i++)
    {
        //SMB_BASE + 0 is SMBUS status value
        data = inportb(SMBUS_PORT);//Read SMBUS status value once
        data = check_data(SMBUS_PORT);//Read SMBUS status value several
        timesoutportb(SMBUS_PORT, data);//Write back SMBUS status value which
        will clear status value (Write 1 to the corresponding bit means clearing status)

        if (data & 0x02)
        {
            //If bit 1 is set (which means the command is completed),
            SMBUS is ready
            result = 0;//SMBUS ready
            break;
        }

        if (!(data & 0xBF))
        {
            //If all bits are 0 except bit 2 (which means error occurs on
            SMBUS), SMBUS is ready
            result = 0;//SMBUS ready
            break;
        }

        if (data & 0x04)
        {
            //If bit 2 is set (which means error occurs on SMBUS), error
            occurs on SMBUS which is rarely the case
            result = 1;//SMBUS error
            break;
        }
    }
}

```

```

        returnresult;
    }

    ///////////////////////////////////////////////////////////////////
    BYTE  check_data(WORD addr)
    {
        int  i;
        BYTE data;

        for(i = 0; i <= 6; i++)
        {
            data = inportb(addr);
            if (data != 0)
                break;
        }

        returndata;
    }

    ///////////////////////////////////////////////////////////////////
    void  newiodelay()
    //Shorter delay
    {
        outportb(0xeb, 0); //IO port 0xeb No real device occupies. Write a value to
        this port can realize delay function. You can also choose other method according to
        the real situation.
    }

    ///////////////////////////////////////////////////////////////////
    void  moredelay()
    //Longer delay
    {
        int  i;
        for (i = 0; i < 20; i++)
        {
            outportb(0xeb, 0); //IO port 0xeb No real device occupies. Write a
            value to this port can realize delay function. You can also choose other method
            according to the real situation.
        }
    }
}

```

GPIO Simcodes

(Here GPIO 00 and GPIO 07 in Chapter 2 are taken as examples)

Output High to GPIO 00:

```
data = smbus_read_byte(0x40, 0x03); // Read slave 0x40 register 3 byte
```

```
data &= 0xfe;//bit 0 is set as 0
smbus_write_byte(0x40, 0x03, data)//Write back. GPIO 00 is set for output
data = smbus_read_byte(0x40, 0x01)//Read slave 0x40 register 1
data |= 0x01;//bit 0 is set as 1 which stands for high
smbus_write_byte(0x40, 0x01, data)//Write back. Output high value
```

Read Input Value from GPIO 07:

```
data = smbus_read_byte(0x40, 0x03);//Read slave 0x40 register 3 byte
data |= 0x80;//bit 7??1
smbus_write_byte(0x40, 0x03, data)//Write back. GPIO 07 is set for input
data = smbus_read_byte(0x40, 0x00)//Read slave 0x40 register 0. Then,
the response value of bit 7 should know whether the input is low or high
```

Appendix **A**

Programming the
Watchdog Timer

A.1 Programming the Watchdog Timer

The ITA-3630's watchdog timer can be used to monitor system software operation and take corrective action if the software fails to function within the programmed period. This section describes the operation of the watchdog timer and how to program it.

A.1.1 Watchdog Timer Overview

The watchdog timer is built into the super I/O controller SMSC SCH3114. It provides the following user-programmable functions:

- Can be enabled or disabled via user program
- Timer can be set from 1 to 255 seconds or 1 to 255 minutes
- Generates an interrupt or resets signal if the software fails to reset the timer before time-out

A.1.2 Programming the Watchdog Timer

The I/O port address of the watchdog timer is 680h (hex).

Table A.1: Watchdog Timer Registers

Address: 680h (hex)

Register Shift	Read/Write	Description
65 (hex)	write	Set seconds or minutes as units for the timer. Write 0 to bit 7: set second as counting unit. [default] Write 1 to bit 7: set minutes as counting unit.
66 (hex)	write	0: Stop timer [default] 01~FF (hex): The amount of the count, in seconds or minutes, depends on the value set in register 65 (hex). This number decides how long the watchdog timer waits for strobe before generating an interrupt or reset signal. Writing a new value to this register can reset the timer to count with the new value.
67 (hex)	read/write	Configure watchdog timer Bit 1: Write 1 to enable keyboard to reset the timer, 0 to disable. [default] Bit 2: Write 1 to enable mouse to reset the timer, 0 to disable. [default] Bit 7~4: Set the interrupt mapping of watchdog timer: 1111=IRQ15 0011=IRQ3 0010=IRQ2 0001=IRQ1 0000=Disable [default]
68 (hex)	read/write	Control watchdog timer Bit0: Read watchdog state; 1=Timer timeout Bit2: Write 1 to immediately generate timeout signal, and automatically return to 0 (Write only). Bit3: Write 1 to allow triggering of timer timeout when P20 is effective, 0 to disable. [default]

A.1.3 Example Program

```

;-----
1.  Enable watchdog timer and set 10 sec. as timeout interval
;-----
Mov dx,A65h ; Select register 65h, watchdog timer I/O port address 680h+ register
shifts 65h
Mov al,80h ; Set second as counting unit
Out dx,al

Mov dx,A66h ; Select register 66h, watchdog timer I/O port address 680h+ register
shift 66h
Mov al,10 ; Set timeout interval as 10 seconds and start counting
Out dx,al

;-----
2.  Enable watchdog timer and set 5 min. as timeout interval
;-----
Mov dx,A65h ; Select register 65h, watchdog timer I/O port address 680h+ register
shifts 65h
Mov al,00h ; Set minute as counting unit
Out dx,al
680h
Mov dx,A66h ; Select register 66h, watchdog timer I/O port address 680h+ register
shifts 66h
Mov al,5 ;Set timeout interval as 5 minutes and start counting
Out dx,al

;-----
3.  Enable watchdog timer to be reset by mouse
;-----
Mov dx,A67h ; Select register 67h, watchdog timer I/O port address 680h+ register
shifts 67h
In al,dx
Or al,4h ; Enable watchdog timer to be reset by mouse
Out dx,al

;-----
4.  Enable watchdog timer to be reset by keyboard
;-----
Mov dx,A67h ; Select register 67h, watchdog timer I/O port address 680h+ register
shifts 67h
In al,dx
Or al,2h ; Enable watchdog timer to be reset by keyboard
Out dx,al

;-----
5.  Generate a time-out signal without timer counting
;-----
Mov dx,A68h ; Select register 68h, watchdog timer I/O port address 680h+ register
shifts 68h
In al,dx
Or al,4h ; Generate a time-out signal
Out dx,al
;-----

```

ADVANTECH

Enabling an Intelligent Planet

www.advantech.com

Please verify specifications before quoting. This guide is intended for reference purposes only.

All product specifications are subject to change without notice.

No part of this publication may be reproduced in any form or by any means, electronic, photocopying, recording or otherwise, without prior written permission of the publisher.

All brand and product names are trademarks or registered trademarks of their respective companies.

© Advantech Co., Ltd. 2014