



GBU4A thru GBU4M

Glass Passivated Single-Phase Bridge Rectifiers
Reverse Voltage 50 to 1000 Volts Forward Current 4.0 Amperes

Features

- ◆ Ideal for printed circuit boards
- ◆ High surge current capability
- ◆ High case dielectric strength of 1500 V_{RMS}
- ◆ Solder Dip 260 °C, 40 seconds

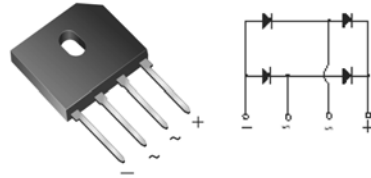

Mechanical Data

- ◆ Case: GBU
Epoxy meets UL-94V-0 Flammability rating
- ◆ Terminals: Matte tin plated (E3 Suffix) leads, solderable per J-STD-002B and JESD22-B102D
- ◆ Polarity: As marked on body
- ◆ Mounting Torque: 10 cm-kg (8.8 inches-lbs) max.
- ◆ Recommended Torque: 5.7 cm-kg (5 inches-lbs)

Typical Applications

General purpose use in ac-to-dc bridge full wave rectification for Monitor, TV, Printer, Switching Mode Power Supply, Adapter, Audio equipment, and Home Appliances applications.

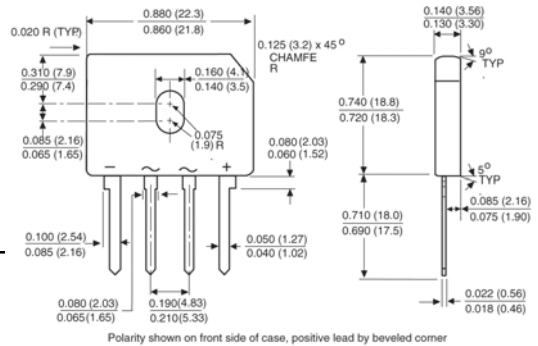

Maximum Ratings and Electrical Characteristics

T_A = 25 °C, unless otherwise specified.

Parameter	Symbols	GBU4A	GBU4B	GBU4D	GBU4G	GBU4J	GBU4K	GBU4M	Units
Maximum repetitive peak reverse voltage	V _{RRM}	50	100	200	400	600	800	1000	Volts
Maximum RMS voltage	V _{RMS}	35	70	140	280	420	560	700	Volts
Maximum DC blocking voltage	V _{DC}	50	100	200	400	600	800	1000	Volts
Maximum average forward rectified output current at	T _C =100°C ⁽¹⁾ T _A =40°C ⁽²⁾				4.0				Amps
Peak forward surge current, 8.3ms single half sine-wave superimposed on rated load (JEDEC Method)	I _{FSM}				150.0				Amps
Rating for fusing (t<8.3ms)	I _t				93				A ² sec
Maximum instantaneous forward voltage drop per leg at 2.0A	V _F				1.0				Volt
Maximum DC reverse current at rated DC blocking voltage per leg	T _A =25°C T _A =125°C				5.0 500.0				uA
Typical junction capacitance per leg at 4.0V, 1MHz	C _J				100				pF
Typical thermal resistance per leg	R _{θJA} ⁽²⁾ R _{θJC} ⁽¹⁾				22 4.2				°C/W
Operating junction and storage temperature range	T _J , T _{STG}				-55 to +150				°C

- Notes:**
1. Unit case mounted on 1.6 x 1.6 x 0.06" thick (5.1 x 5.1 x 0.15 cm) Al. Plate
 2. Units mounted on P.C.B. with 0.5 x 0.5" (12.7 x 12.7 mm) copper pads and 0.375" (9.5 mm) lead length

RATINGS AND CHARACTERISTIC CURVES

($T_A = 25^\circ\text{C}$ unless otherwise noted)

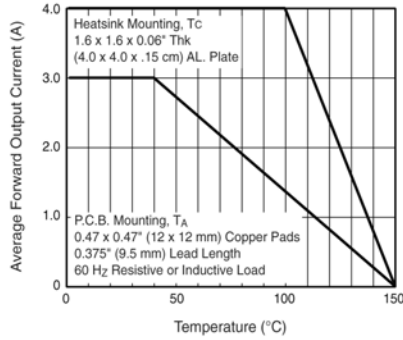

Figure 1. Derating Curve Output Rectified Current

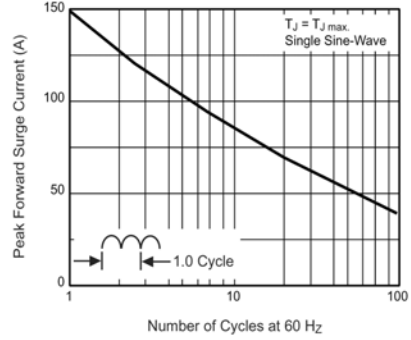

Figure 2. Maximum Non-Repetitive Peak Forward Surge Current Per Leg

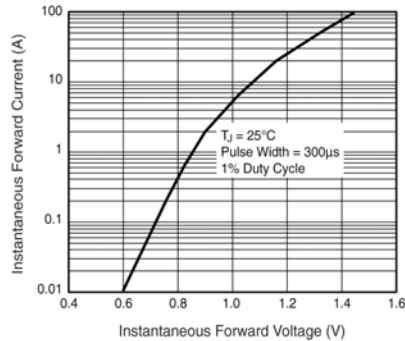

Figure 3. Typical Forward Characteristics Per Leg

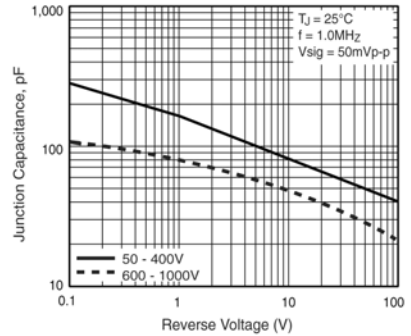

Figure 5. Typical Junction Capacitance Per Leg

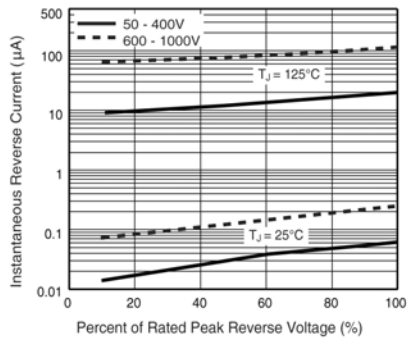

Figure 4. Typical Reverse Leakage Characteristics Per Leg

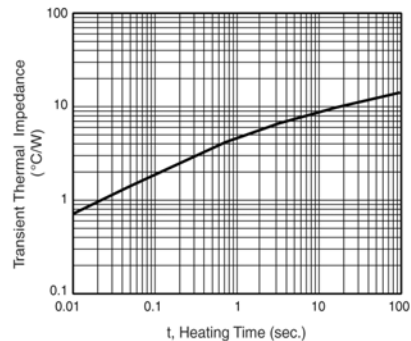

Figure 6. Typical Transient Thermal Impedance