

SM Board to 32MX7 Board Connector

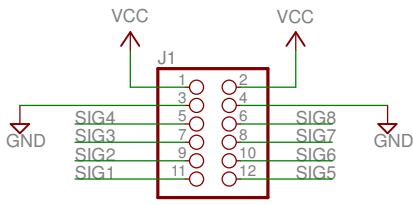

Board VDD Power Filter Caps

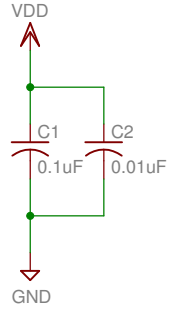

Board VDD Power LED

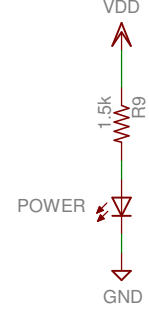

32MX7 Signal LEDs

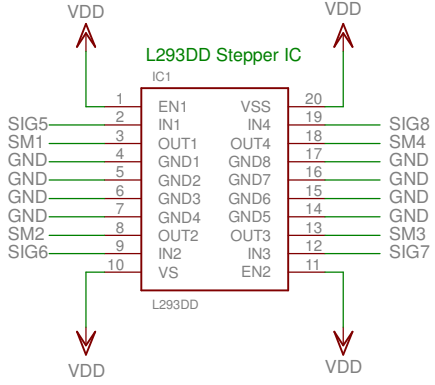
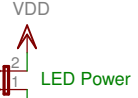
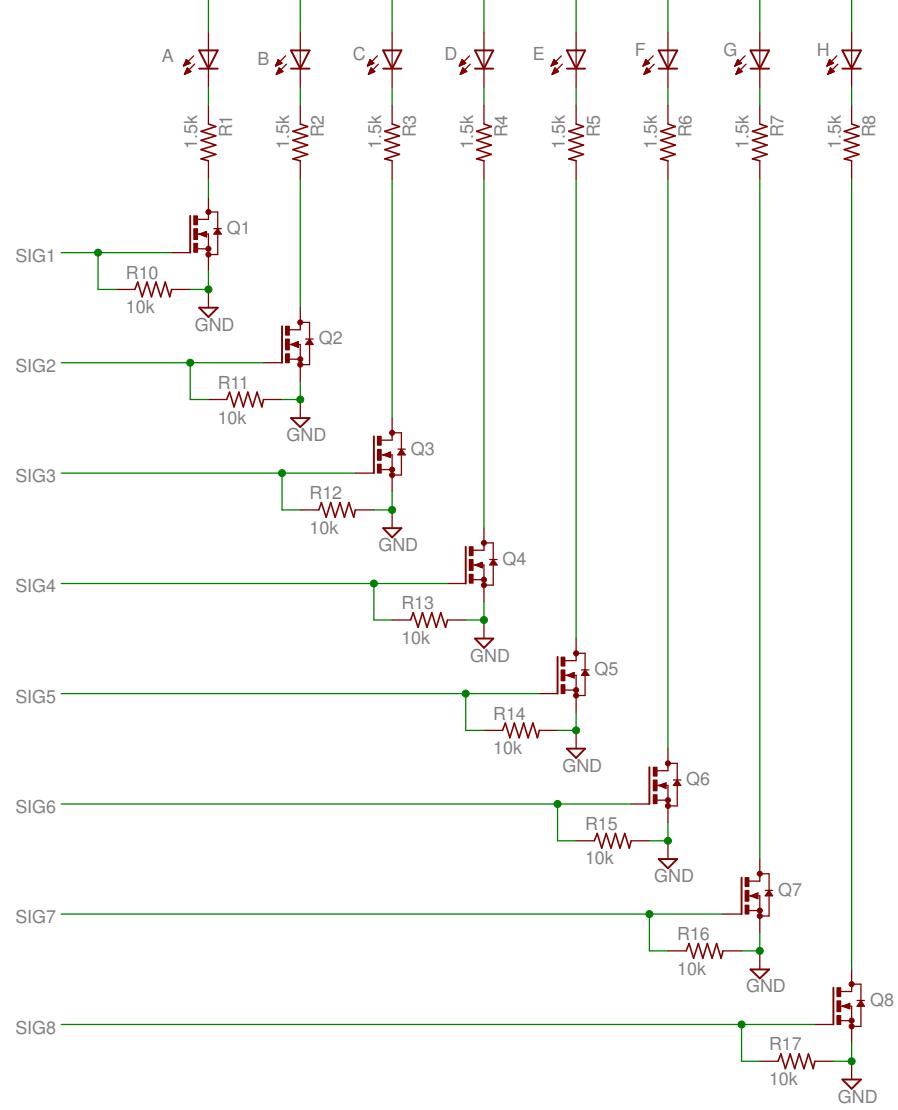

4-Wire Stepper Motor Header

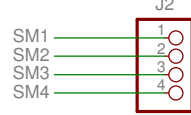

6-Wire Stepper Motor Header



Power Select Jumper

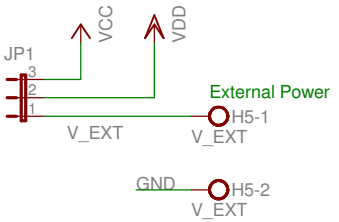

32MX7 Signal Headers

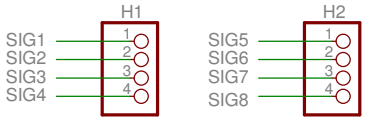

V_EXT Measure Point



Ground Header

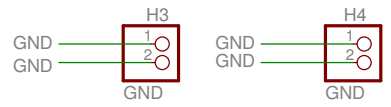

UI ECE 341 Lab

TITLE: Stepper Motor Board

Document Number:

REV: 1

Date: 7/16/2012 12:55:24 PM

Sheet: 1/1