

1k, 2k, 4k, bit EEPROMs for direct connection to serial ports

**BR9010-W / BR9010F-W / BR9010FV-W /
BR9010RFV-W / BR9010RFVM-W
BR9020-W / BR9020F-W / BR9020FV-W /
BR9020RFV-W / BR9020RFVM-W
BR9040-W / BR9040F-W / BR9040FV-W /
BR9040RFV-W / BR9040RFVM-W**

The BR90XX series are serial EEPROMs that can be connected directly to a serial port and can be erased and written electrically. Writing and reading is performed in word units, using four types of operation commands. Communication occurs through \overline{CS} , \overline{SK} , DI, and DO pins, \overline{WC} pin control is used to initiate a write disabled state, enabling these EEPROMs to be used as one-time ROMs. During writing operation is checked via the internal status check.

●Application

General-Purpose

●Features

- 1) BR9010-W / F-W / FV-W / RFV-W / RFVM-W (1k bit) : 64 words × 16bit
BR9020-W / F-W / FV-W / RFV-W / RFVM-W (2k bit) : 128words × 16bit
BR9040-W / F-W / FV-W / RFV-W / RFVM-W (4k bit) : 256words × 16bit
- 2) Single power supply.
- 3) Serial data I/O.
- 4) Self-timed programming cycle with auto-erase.
- 5) Low supply current.
Active (5V) : 2mA (max.)
Standby (5V) : 3 μ A (max.) (CMOS INPUT)
- 6) Noise filter on the \overline{SK} pin. Write protection when the supply is low.
- 7) Write protection by \overline{WC} pin.
- 8) Space Saving DIP8/SOP8/SSOP-B8/MSOP8pin Packages.
- 9) 100,000 erase/ write cycles endurance.
- 10) Provide 10 years of date retention.
- 11) Easy connection to serial port.
- 12) "FFFFh" stored in all address on shipped.

●Block diagram

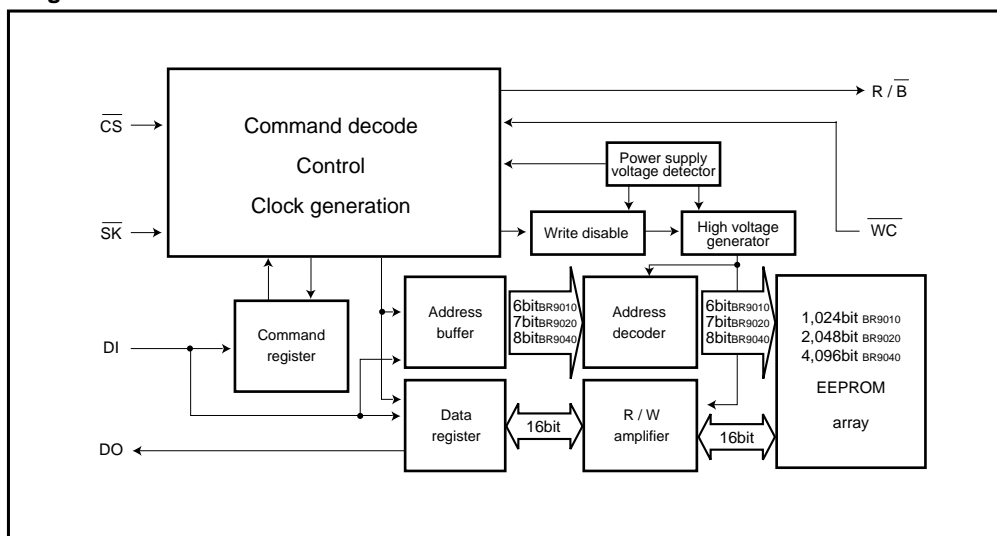

●Terminal Function

Pin No.		Pin name	Function
BR90xx-W/RFV-W/RFVM-W	BR90xxF-W/FV-W		
1	3	\overline{CS}	Chip Select Input
2	4	\overline{SK}	Serial Date Clock Input
3	5	DI	Serial Date Input (Op code, address)
4	6	DO	Serial Date Output
5	7	GND	Ground (0V)
6	8	\overline{WC}	Write Control Input
7	1	R/\overline{B}	READY/ \overline{BUSY} Status Output
8	2	V _{cc}	Power Supply

BR9010-W / F-W / FV-W / RFV-W / RFVM-W / BR9020-W / F-W / FV-W /
Memory IC RFV-W / RFVM-W / BR9040-W / F-W / FV-W / RFV-W / RFVM-W

● **Absolute Maximum Ratings** (Ta=25°C)

Parameter		Symbol	Limits		Unit
Supply Voltage		V _{cc}	-0.3 to +7.0		V
Power dissipation	BR9010-W, BR9020-W, BR9040-W	Pd	DIP8	800* ¹	mW
	BR9010F-W, BR9020F-W, BR9040F-W		SOP8	450* ²	
	BR9010FV-W, BR9010RFV-W, BR9020FV-W, BR9020RFV-W, BR9040FV-W, BR9040RFV-W		SSOP-B8	300* ³	
	BR9010RFVM-W, BR9020RFVM-W, BR9040RFVM-W		MSOP8	310* ⁴	
Storage Temperature		T _{stg}	-65 to +125		°C
Operating Temperature		T _{opr}	-40 to +85		°C
Terminal Voltage		-	-0.3 to V _{cc} +0.3		V

*1 Degradation is done at 8.0mW/°C for operation above Ta=25°C

*2 Degradation is done at 4.5mW/°C for operation above Ta=25°C

*3 Degradation is done at 3.0mW/°C for operation above Ta=25°C

*4 Degradation is done at 3.1mW/°C for operation above Ta=25°C

● **Recommended Operating Condition** (Ta=25°C)

Parameter		Symbol	Min.	Typ.	Max.	Unit
Supply voltage	Write	V _{cc}	2.7	-	5.5	V
	Read		2.7	-	5.5	V
Input voltage		V _{IN}	0	-	V _{cc}	V

BR9010-W / F-W / FV-W / RFV-W / RFVM-W / BR9020-W / F-W / FV-W /
Memory IC RFV-W / RFVM-W / BR9040-W / F-W / FV-W / RFV-W / RFVM-W

●Electrical Characteristics

Unless otherwise specified (Ta= -40 to +85°C, Vcc=2.7V to 5.5V)

Parameter	Symbol	Min.	Typ.	Max.	Unit	Conditions
Input LOW Voltage 1	V _{IL1}	–	–	0.3×V _{CC}	V	DI pin
Input HIGH Voltage 1	V _{IH1}	0.7×V _{CC}	–	–	V	DI pin
Input LOW Voltage 2	V _{IL2}	–	–	0.2×V _{CC}	V	\overline{CS} , \overline{SK} , \overline{WC} pin
Input HIGH Voltage 2	V _{IH2}	0.8×V _{CC}	–	–	V	\overline{CS} , \overline{SK} , \overline{WC} pin
Output LOW Voltage	V _{OL}	0	–	0.4	V	I _{OL} =2.1mA
Output HIGH Voltage	V _{OH}	V _{CC} –0.4	–	V _{CC}	V	I _{OH} =–0.4mA
Input Leakage Current	I _{L1}	–1	–	1	μA	V _{IN} =0V to V _{CC}
Output Leakage Current	I _{LO}	–1	–	1	μA	V _{OUT} =0V to V _{CC} , \overline{CS} =V _{CC}
Operating Current	I _{CC1}	–	–	2	mA	f _{SK} =2MHz, tE / W=10ms (WRITE)
	I _{CC2}	–	–	1	mA	f _{SK} =2MHz (READ)
Standby Current	I _{SB}	–	–	3	μA	\overline{CS} , \overline{SK} , DI, \overline{WC} =V _{CC} , DO, R / \overline{B} =OPEN
Clock Frequency	f _{SK}	–	–	2	MHz	–

Unless otherwise specified (Ta= -40 to +85°C, Vcc=2.7V to 3.3V)

Parameter	Symbol	Min.	Typ.	Max.	Unit	Conditions
Input LOW Voltage 1	V _{IL1}	–	–	0.3×V _{CC}	V	DI pin
Input HIGH Voltage 1	V _{IH1}	0.7×V _{CC}	–	–	V	DI pin
Input LOW Voltage 2	V _{IL2}	–	–	0.2×V _{CC}	V	\overline{CS} , \overline{SK} , \overline{WC} pin
Input HIGH Voltage 2	V _{IH2}	0.8×V _{CC}	–	–	V	\overline{CS} , \overline{SK} , \overline{WC} pin
Output LOW Voltage	V _{OL}	0	–	0.4	V	I _{OL} =100μA
Output HIGH Voltage	V _{OH}	V _{CC} –0.4	–	V _{CC}	V	I _{OH} =–100μA
Input Leakage Current	I _{L1}	–1	–	1	μA	V _{IN} =0V to V _{CC}
Output Leakage Current	I _{LO}	–1	–	1	μA	V _{OUT} =0V to V _{CC} , \overline{CS} =V _{CC}
Operating Current	I _{CC1}	–	–	1.5	mA	f _{SK} =2MHz, tE / W=10ms (WRITE)
	I _{CC2}	–	–	0.5	mA	f _{SK} =2MHz (READ)
Standby Current	I _{SB}	–	–	2	μA	\overline{CS} , \overline{SK} , DI, \overline{WC} =V _{CC} , DO, R / \overline{B} =OPEN
Clock Frequency	f _{SK}	–	–	2	MHz	–

BR9010-W / F-W / FV-W / RFV-W / RFVM-W / BR9020-W / F-W / FV-W /
Memory IC RFV-W / RFVM-W / BR9040-W / F-W / FV-W / RFV-W / RFVM-W

●AC Operation Characteristics

(Ta=-40 to +85°C, Vcc=2.7 to 5.5V)

Parameter	Symbol	Min.	Typ.	Max.	Unit
Chip Select Setup Time	t _{CSS}	100	-	-	ns
Chip Select Hold Time	t _{CSH}	100	-	-	ns
Data In Setup Time	t _{DIS}	100	-	-	ns
Data In Hold Time	t _{DIH}	100	-	-	ns
Delay to Output High	t _{PD1}	-	-	150	ns
Delay to Output Low	t _{PD0}	-	-	150	ns
Self-Timed Program Cycle	t _{E / W}	-	-	10	ms
Minimum Chip Select High Time	t _{Cs}	250	-	-	ns
Data Output Disable Time(From \overline{CS})	t _{OH}	0	-	150	ns
Clock High Time	t _{WH}	230	-	-	ns
Clock Low Time	t _{WL}	230	-	-	ns
Write Control Setup Time	t _{WCS}	0	-	-	ns
Write Control Hold Time	t _{WCH}	0	-	-	ns
Clock High to Output READY/BUSY Status	t _{SV}	-	-	150	ns

● I/O Circuit

(1) Input Circuit

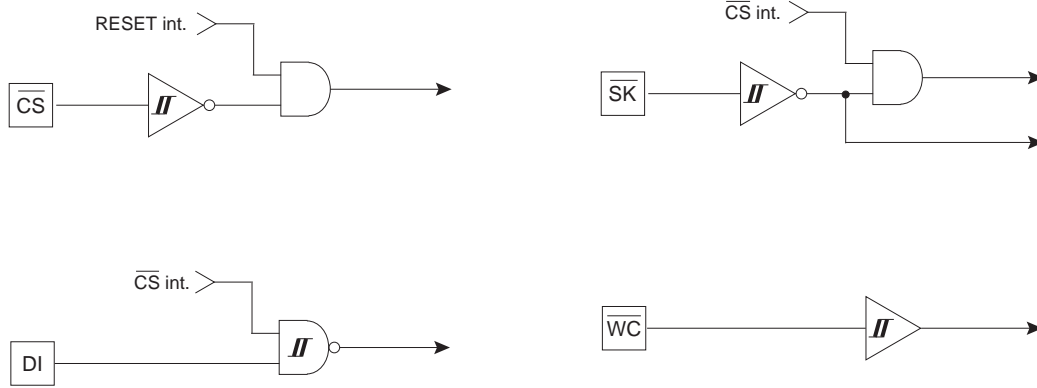

(2) Output Circuit

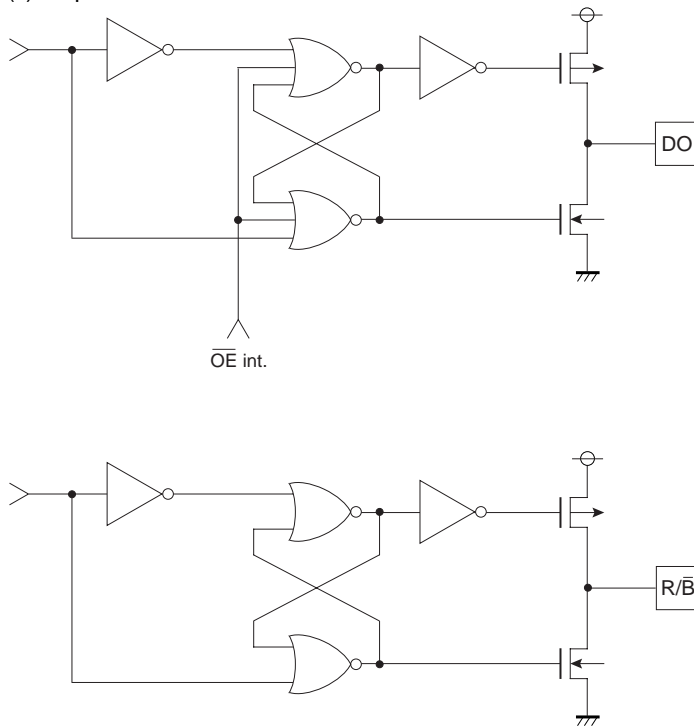

BR9010-W / F-W / FV-W / RFV-W / RFVM-W / BR9020-W / F-W / FV-W /
Memory IC RFV-W / RFVM-W / BR9040-W / F-W / FV-W / RFV-W / RFVM-W

●Operating

(1) Instruction Code

Instruction	Start Bit	Op Code	Address	Data
READ	1010	1000	A0 A1 A2 A3 A4 A5 (A6) ^{*2} (A7) ^{*1}	D0 D1–D14 D15 (READ DATA)
WRITE	1010	0100	A0 A1 A2 A3 A4 A5 (A6) ^{*2} (A7) ^{*1}	D0 D1–D14 D15 (WRITE DATA)
Write Enable (WEN)	1010	0011	* * * * * * * *	
Write Disable (WDS)	1010	0000	* * * * * * * *	

Address and data must be transferred from LSB.
 * Means either V_{IH} or V_{IL}
 BR9020-W/F-W/FV-W/RFV-W/RFVM-W *1= "0"
 BR9010-W/F-W/FV-W/RFV-W/RFVM-W *1, 2= "0"

Synchronous Data Input Output Timing

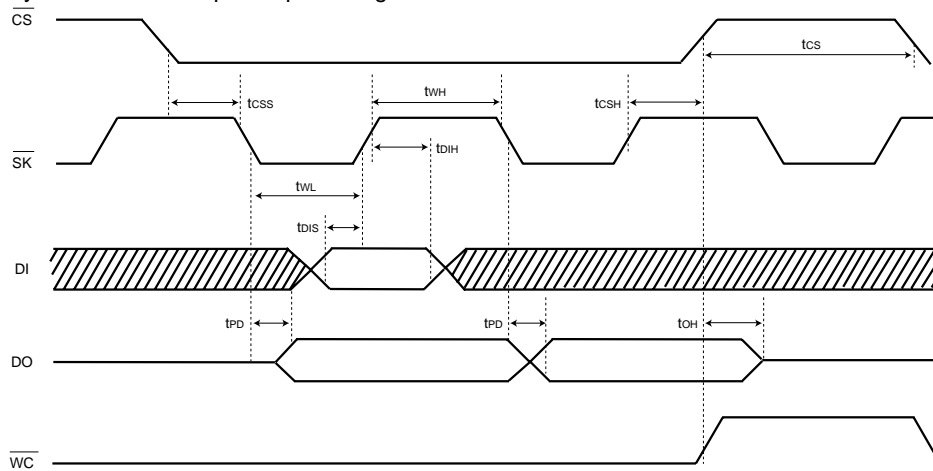

Fig.1

- Input Data is clocked into the DI pin on the rising edge of the clock \overline{SK}
- Output data is clocked out on the falling edge of the \overline{SK} clock.
- The WC pin does not have any affect on the READ, WEN and WDS operations.
- Between instructions, \overline{CS} must be brought High for greater than the minimum of t_{cs}. If \overline{CS} is maintained Low, the next instruction isn't detected.

(2) WRITE Enable / Disable

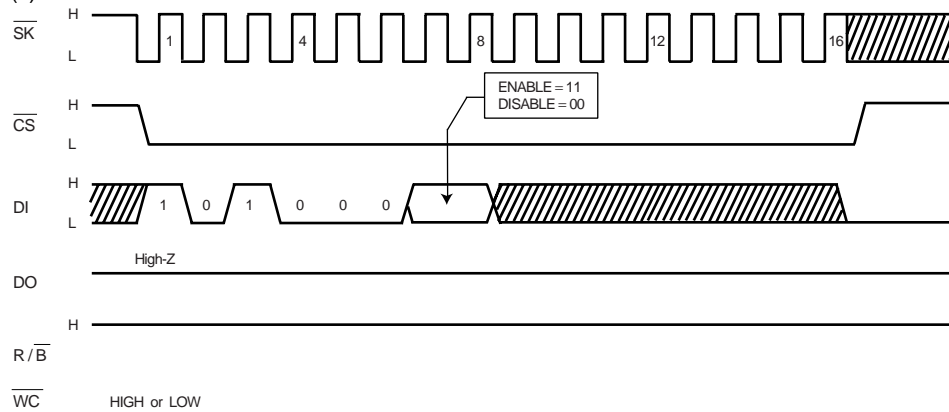

Fig.2

- 1) When power is first applied, the device has been held in a reset status, with respect to the write enable, in the same way the write disable (WDS) instruction is executed. Before the write instruction is executed, the device must be received the write enable (WEN) instruction. Once the device is done, the device remains programmable until the write disable (WDS) instruction is executed or the supply is removed from the device.
- 2) It is unnecessary to add the clock after 16th clock. If the device is received the clock, the device ignores the clock.
- 3) As both of the enable and disable instructions don't depend on the status of the \overline{WC} pin, the state of \overline{WC} isn't cared during the instruction.
- 4) The instruction is recognized after the rising edge of 8th clock for the address following 8 clocks for the opcode, but the specified address isn't cared during the instructions.

BR9010-W / F-W / FV-W / RFV-W / RFVM-W / BR9020-W / F-W / FV-W /
 Memory IC RFV-W / RFVM-W / BR9040-W / F-W / FV-W / RFV-W / RFVM-W

(3) Read Cycle

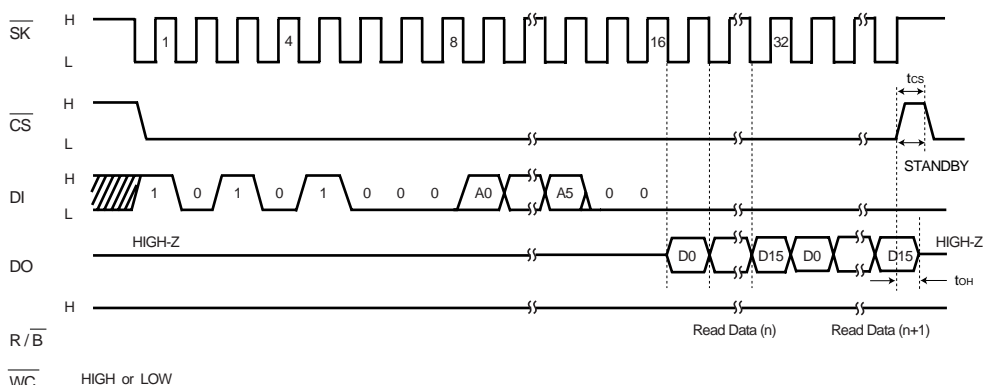

Fig.3 BR9010-W / F--W / FV-W / RFV-W / RFVM-W

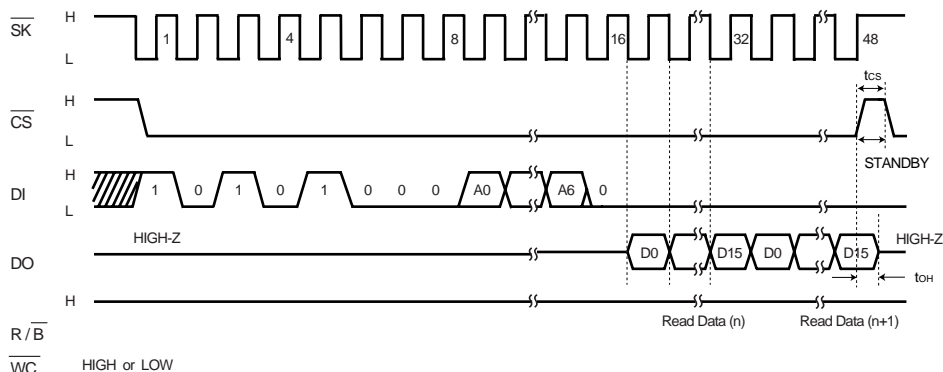

Fig.4 BR9020-W / F-W / FV-W / RFV-W / RFVM-W

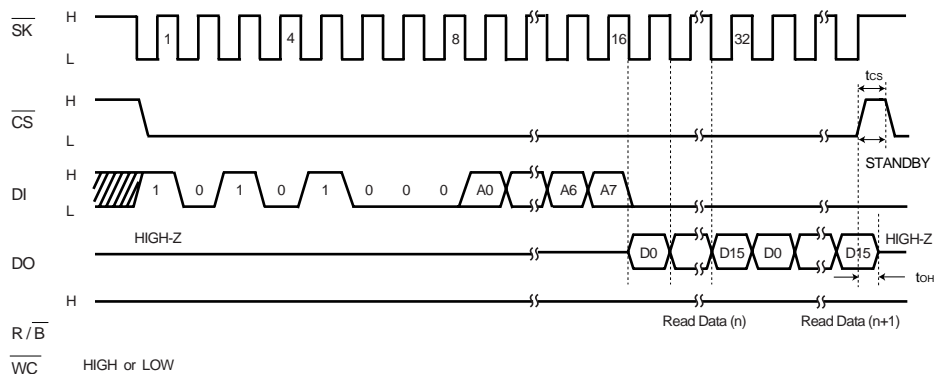

Fig.5 BR9040-W / F-W / FV-W / RFV-W / RFVM-W

- 1) On the falling edge of 16th clock, the data stored in the specified address (n) is clocked out of the DO pin. The Output DO is toggled after the internal propagation t_{PD0} or t_{PD1} on the falling edge of \overline{SK} . During t_{PD0} or t_{PD1} , the data is the previous data or unstable, and to take in the data, t_{PD} is needed. (Refer to Fig.1 Synchronous data input output timing.)
- 2) The data stored in the next address is clocked out of the device on the falling edge of 32nd clock. The data stored in the upper address every 16 clocks is output sequentially by the continual SK input. Also the read operation is reset by CS High.

BR9010-W / F-W / FV-W / RFV-W / RFVM-W / BR9020-W / F-W / FV-W /
 Memory IC RFV-W / RFVM-W / BR9040-W / F-W / FV-W / RFV-W / RFVM-W

(4) Write Cycle

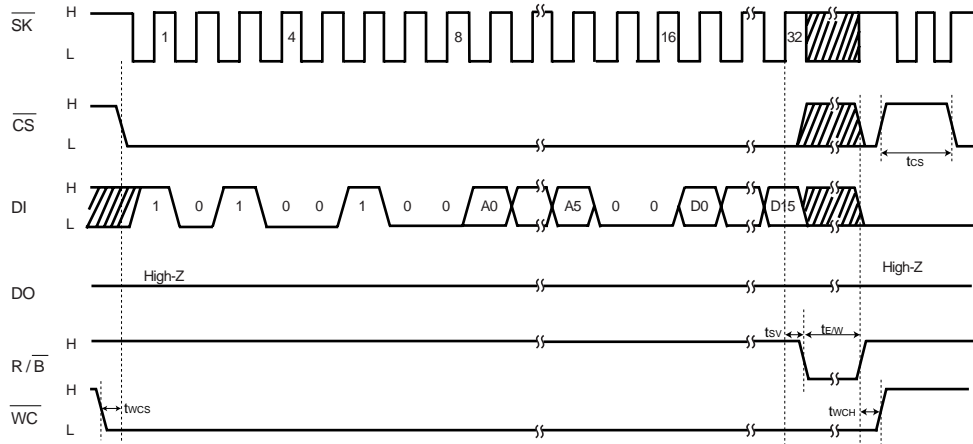

Fig.6 BR9010-W / F-W / FV-W / RFV-W / RFVM-W

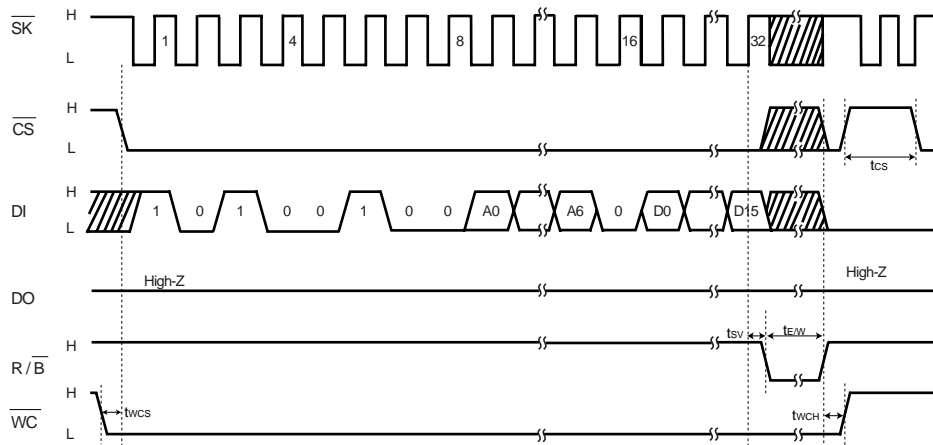

Fig.7 BR9020-W / F-W / FV-W / RFV-W / RFVM-W

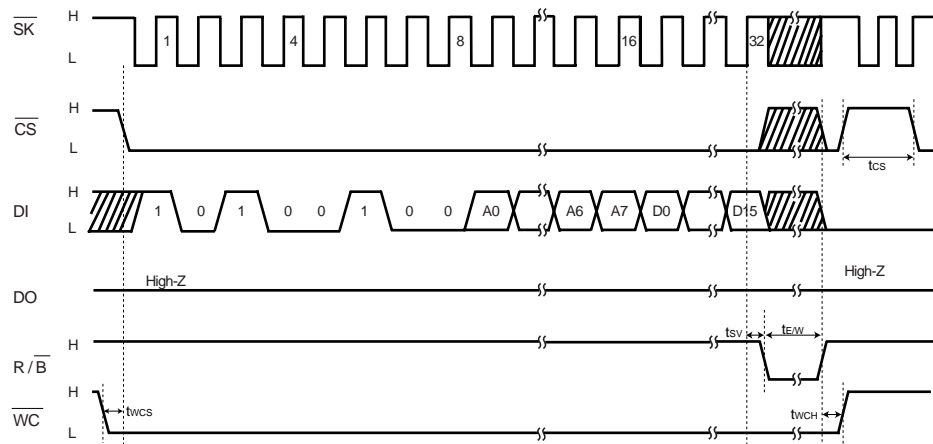

Fig.8 BR9040-W / F-W / FV-W / RFV-W / RFVM-W

- 1) During the write instruction, \overline{CS} must be brought Low. However once the write operation started, \overline{CS} may be either High or Low. But in the case of connecting the \overline{WC} pin to the \overline{CS} pin, \overline{CS} and \overline{WC} must be brought Low during programming cycle. (If the \overline{WC} pin is brought High during the write cycle, the write operation is halted. In that case, the data of the specified address is not guaranteed. It is necessary to rewrite it.)
- 2) After the R/\overline{B} pin changed Busy to Ready, once \overline{CS} is brought High, then \overline{CS} keep Low, which means the status of being able to accept an instruction. The device can take in the input from \overline{SK} and \overline{DI} , but in the case of keeping \overline{CS} Low without being brought High once, the input is canceled until being \overline{CS} High once.
- 3) At the rising edge of 32 nd clock, the R/\overline{B} pin will be driven Low after the specified time delay (t_{SV}).
- 4) During programming, R/\overline{B} is tied to Low by the device (On the rising edge of \overline{SK} taken in the last data (D15), internal timer starts and automatically finished after the data of memory cell is written spending tE/W . \overline{SK} could be either High or Low at the time.
- 5) After input write instruction, also the \overline{DO} pin will be able to show the status of R/\overline{B} , in the case that \overline{CS} is falling from High to Low while \overline{SK} is tied to Low. (Refer to READY / BUSY STATUS in the next page.)

(5) READY / BUSY STATUS (on the R/\overline{B} pin, the \overline{DO} pin)

- 1) The \overline{DO} pin outputs the READY / BUSY status of the internal part, which shows whether the device is ready to receive the next instruction or not. (High or Low) \overline{CS}
 After the write instruction is completed, if \overline{CS} is brought from high to low while \overline{SK} is Low, the \overline{DO} pin outputs the internal status. (The R/\overline{B} pin may be no connection.)
- 2) When written to the memory cell, R/\overline{B} status is output after t_{SV} spent from the rising edge of 32 th clock on \overline{SK} .

R/\overline{B} =Low : under writing

After spending tE/W operating the internal timer, the device automatically finishes writing.
 During tE/W , the memory array is accessed and any instruction is not received.

R/\overline{B} =High : ready

Auto programming has been completed. The device is ready to receive the next Instruction.

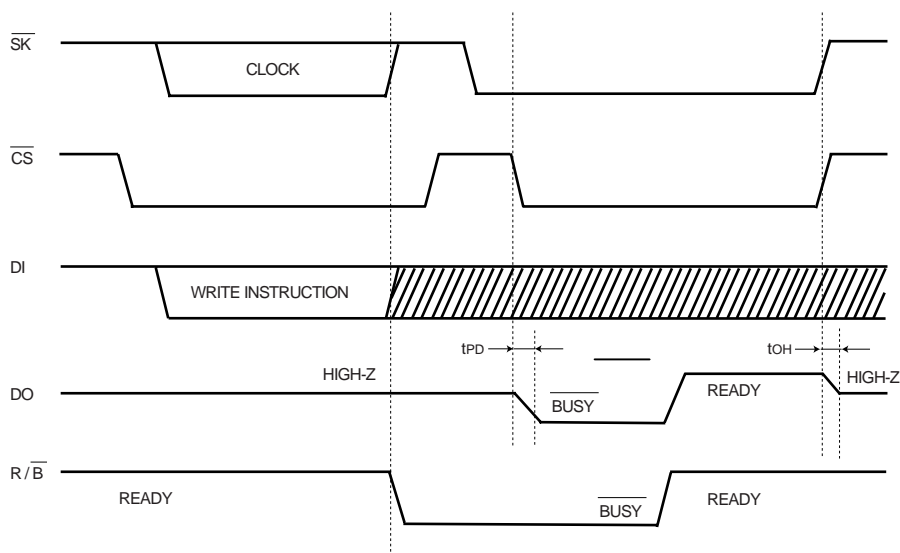

Fig.9 R/\overline{B} Status Output Timing

(6) About the direct connection between the DI and DO pins

The device can be used with the DI pin connected to the DO pin directly.

But when the READY / BUSY status is output, be careful about the bus conflict on the port of the controller.

●Attention to Use

(1) Power ON / OFF

1) The \overline{CS} is brought High during power-up and power-down.

2) This device is in active state while \overline{CS} is Low.

3) The extraordinary function or data collapse may occur in that condition because of noise etc, if power-up and power-down is done with CS brought Low.

In order to prevent above errors from happening, keep \overline{CS} High during power-up and power-down.

(Good example) \overline{CS} is brought High during power-up and power-down.

Please take more than 10ms between power-up and power-off, or the internal circuit is not always reset.

(Bad example) \overline{CS} is brought Low during power-up and power-down.

The \overline{CS} pin is always Low in this case, the noise may force the device to make malfunction or inadvertent write.

It sometimes occurs in the case that the \overline{CS} pin is Hi-Z.

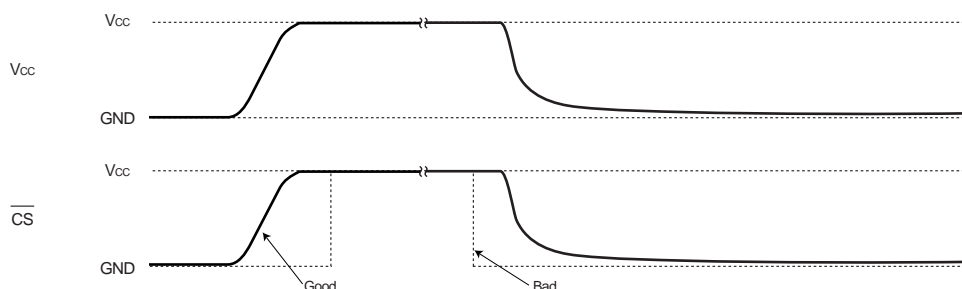

Fig.10

(2) Noise Rejection

1) \overline{SK} NOISE

If \overline{SK} line has a lot of noise for rising time of \overline{SK} , the device may recognize the noise as a clock and then clock will be shifted.

2) \overline{WC} NOISE

If \overline{WC} line has noise during write cycle (tE / W), there may be a chance to deny the programming.

3) VCC NOISE

It recommended that capacitor is put between VCC and GND to prevent these case, since it is possible to occur malfunction by the effect of noise or surge on power line.

(3) Instruction Mode Cancel

1) Read instruction

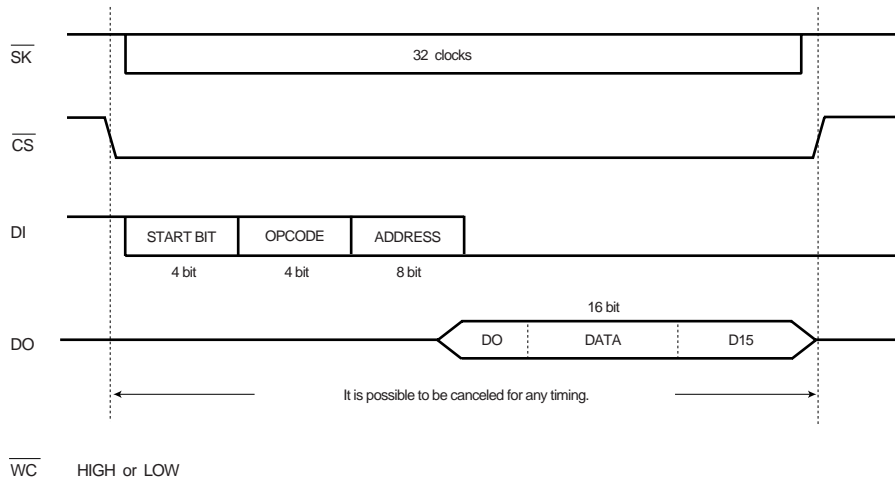

Fig.11

How to cancel : \overline{CS} is brought High.

2) Write instruction

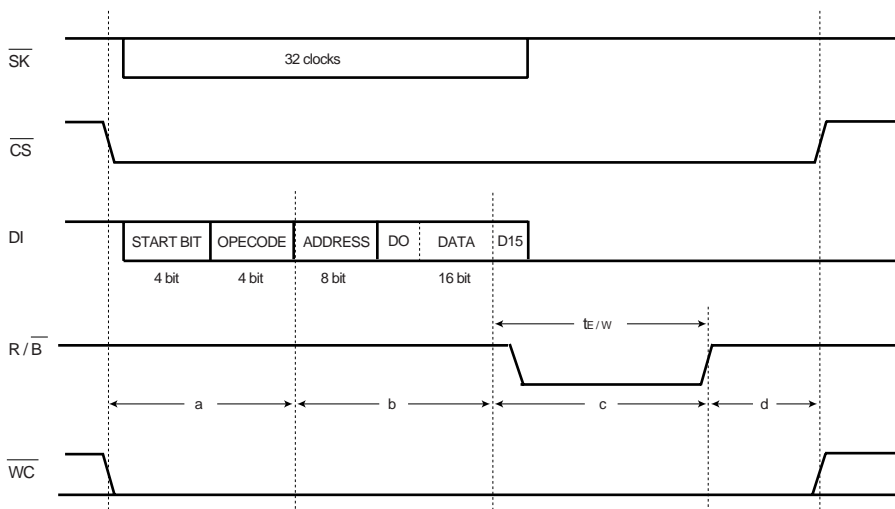

Fig.12

How to cancel

- a : \overline{CS} is brought High to cancel the instruction, and \overline{WC} may be either High or Low.
- b : In case that \overline{WC} is brought High for a moment, or \overline{CS} is brought High, the write instruction is canceled, the data of the specified address is not changed.
- c : When \overline{WC} is brought High, or the device is powered down (But the latter way is not recommended), the instruction is canceled but the specified data is not guaranteed. Send the instruction again.
- d : When \overline{CS} is brought High during $\overline{R/B}$ High, the device is reset and ready to receive a next instruction.

NOTE : The document may be strategic technical data subject to COCOM regulations.

BR9010-W / F-W / FV-W / RFV-W / RFVM-W / BR9020-W / F-W / FV-W /
 Memory IC RFV-W / RFVM-W / BR9040-W / F-W / FV-W / RFV-W / RFVM-W

●External dimensions (Unit : mm)

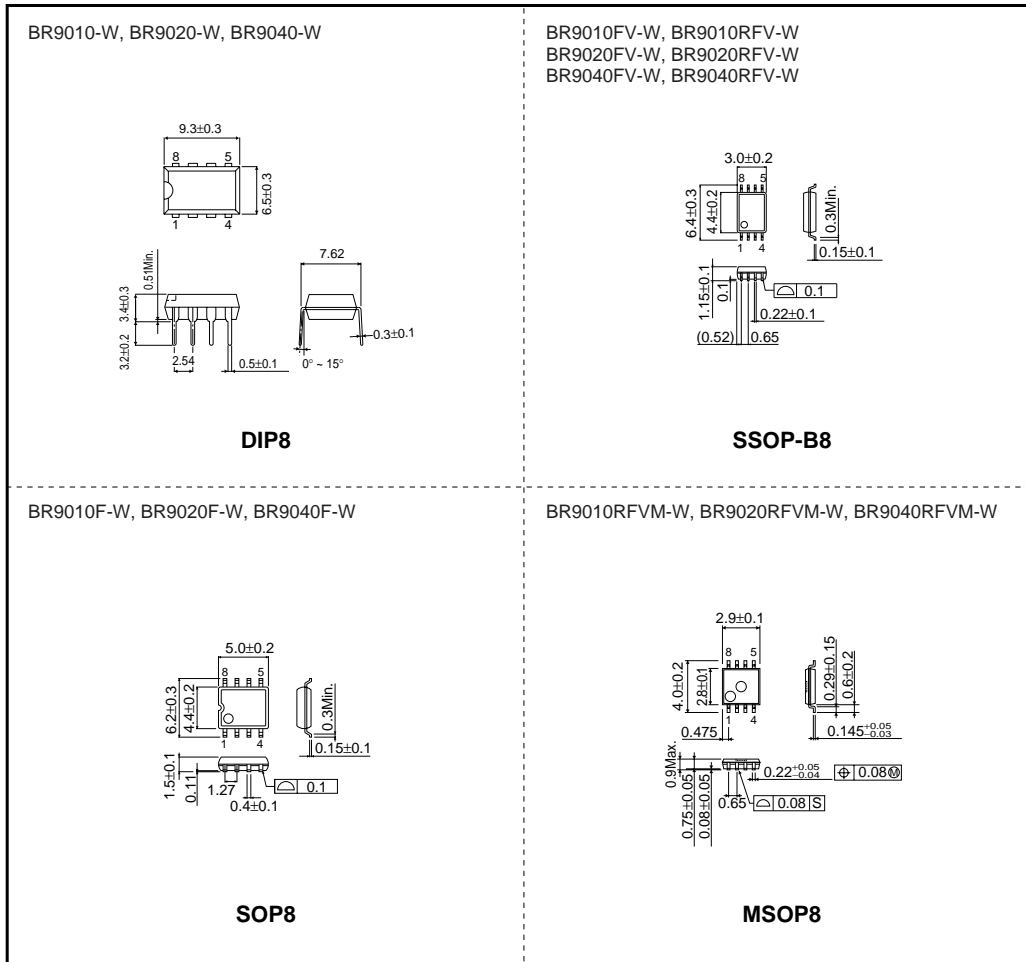

Notes

- No technical content pages of this document may be reproduced in any form or transmitted by any means without prior permission of ROHM CO.,LTD.
- The contents described herein are subject to change without notice. The specifications for the product described in this document are for reference only. Upon actual use, therefore, please request that specifications to be separately delivered.
- Application circuit diagrams and circuit constants contained herein are shown as examples of standard use and operation. Please pay careful attention to the peripheral conditions when designing circuits and deciding upon circuit constants in the set.
- Any data, including, but not limited to application circuit diagrams information, described herein are intended only as illustrations of such devices and not as the specifications for such devices. ROHM CO.,LTD. disclaims any warranty that any use of such devices shall be free from infringement of any third party's intellectual property rights or other proprietary rights, and further, assumes no liability of whatsoever nature in the event of any such infringement, or arising from or connected with or related to the use of such devices.
- Upon the sale of any such devices, other than for buyer's right to use such devices itself, resell or otherwise dispose of the same, no express or implied right or license to practice or commercially exploit any intellectual property rights or other proprietary rights owned or controlled by
- ROHM CO., LTD. is granted to any such buyer.
- Products listed in this document are no antiradiation design.

The products listed in this document are designed to be used with ordinary electronic equipment or devices (such as audio visual equipment, office-automation equipment, communications devices, electrical appliances and electronic toys).

Should you intend to use these products with equipment or devices which require an extremely high level of reliability and the malfunction of which would directly endanger human life (such as medical instruments, transportation equipment, aerospace machinery, nuclear-reactor controllers, fuel controllers and other safety devices), please be sure to consult with our sales representative in advance.

About Export Control Order in Japan

Products described herein are the objects of controlled goods in Annex 1 (Item 16) of Export Trade Control Order in Japan.

In case of export from Japan, please confirm if it applies to "objective" criteria or an "informed" (by MITI clause) on the basis of "catch all controls for Non-Proliferation of Weapons of Mass Destruction.