

Device Features

- OIP3 = 40.0 dBm @ 140 MHz
- Gain = 27.0 dB @ 140 MHz
- Output P1 dB = 21.0 dBm @ 140 MHz
- NF = 2.7 @ 70MHz at Demo Board
- RoHS2-compliant SOT-89 SMT package



Product Description

BeRex's BIG8 is a high performance InGaP/ GaAs HBT MMIC amplifier, internally matched to 50 Ohms. The BIG8 is designed for high linearity IF amplifier that require excellent gain, high OIP3 and flatness. It is packaged in a RoHS2-compliant with SOT-89 surface mount package.

Applications

- Base station Infrastructure/RFID
- Commercial/Industrial

Applications Circuit

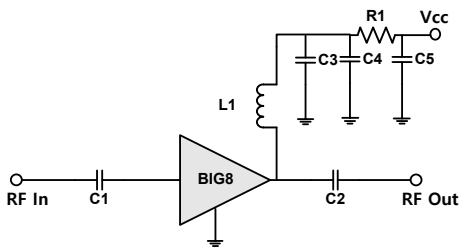

BOM	50~100MHz	100~300MHz	300~600MHz
C1	1000pF	1000pF	100pF
C2	1000pF	1000pF	100pF
C3	100pF	100pF	100pF
C4	1000pF	1000pF	1000pF
C5	10uF	10uF	10uF
L1	1uH	560nH	100nH
R1	1.6ohm	1.6ohm	1.6ohm

Electrical Specifications

Device performance _ measured on a BeRex evaluation board at 25°C, Vc=5V, 50 Ω system.

Parameter	Conditions	Min	Typ	Max	Unit
Operational Frequency Range		50		600	MHz
Test Frequency			140		MHz
Gain		25.5	27.0		dB
Input Return Loss			-20.0		dB
Output Return Loss			-18.0		dB
Output IP3	8 dBm / tone , Δf=1 MHz	37.0	40.0		dBm
Output P1dB		20.0	21.0		dBm
Noise Figure			2.9		dB

Recommended Operating Conditions

Parameter	Min	Typ	Max	Unit
Bandwidth	50		600	MHz
Ic @ (Vc = 5V)	80	100	120	mA
Vc	4.0	5.0	5.25	V
dG/dT		-0.004		dB/°C
RTH		66.6		°C/W
Operating Case Temperature	-40		+85	°C

Electrical specifications are measured at specified test conditions.

Specifications are not guaranteed over all recommended operating conditions.

Absolute Maximum Ratings

Parameter	Rating	Unit
Storage Temperature	-55 to +155	°C
Junction Temperature	+185	°C
Supply Voltage	+6.5	V
Supply Current	250	mA
Input RF Power	24	dBm

Operation of this device above any of these parameters may result in permanent damage.

Application Circuit: 70-500 MHz

Typical Performance (Vd = 5V, Ic = 94mA, T = 25°C)

Freq	MHz	70	140	200	500
S21	dB	27.0	27.1	26.9	26.0
S11	dB	-21.0	-20.1	-20.4	-18.6
S22	dB	-17.5	-17.8	-18.6	-17.7
P1	dBm	20.7	21.0	21.0	20.2
OIP3	dBm	40.5	40.2	39.0	41.6
NF	dB	2.7	2.9	3.0	3.2

Typical Performance (Vd = 4.7V, Ic = 78mA, T = 25°C)

Freq	MHz	70	140	200	500
S21	dB	26.9	26.9	26.7	25.8
S11	dB	-21.8	-21.6	-21.8	-20.0
S22	dB	-16.7	-16.9	-17.2	-16.5
P1	dBm	20.0	20.1	20.1	19.4
OIP3	dBm	37.5	37.6	36.1	37.5
NF	dB	2.8	2.8	2.8	3.0

Typical Performance (Vd = 4.5V, Ic = 66mA, T = 25°C)

Freq	MHz	70	140	250	500
S21	dB	26.7	26.7	26.5	25.7
S11	dB	-23.3	-23.3	-23.7	-21.1
S22	dB	-15.8	-15.9	-16.2	-15.6
P1	dBm	19.1	19.2	19.1	18.4
OIP3	dBm	34.8	34.9	33.7	34.5
NF	dB	2.8	2.8	2.8	2.9

Typical Performance (Vd = 4V, Ic = 40mA, T = 25°C)

Freq	MHz	70	140	250	500
S21	dB	25.8	25.9	25.7	25.0
S11	dB	-26.8	-29.8	-33.7	-26.9
S22	dB	-12.9	-12.8	-13.0	-12.7
P1	dBm	16.2	16.2	15.5	14.5
OIP3	dBm	28.2	28.3	27.3	25.8
NF	dB	2.7	2.7	2.6	2.7

V-I Characteristics

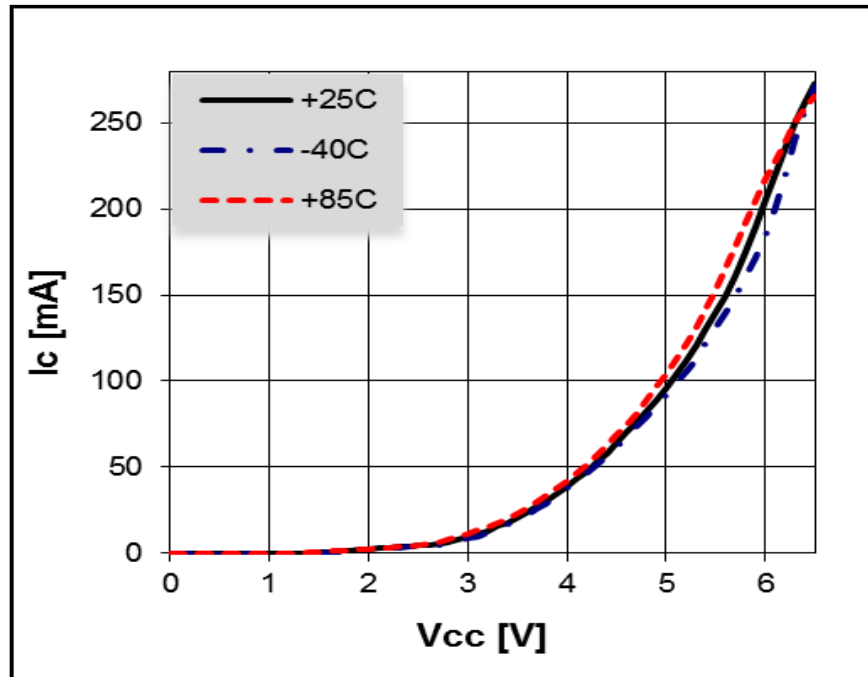

BeRex SOT89 Evaluation Board

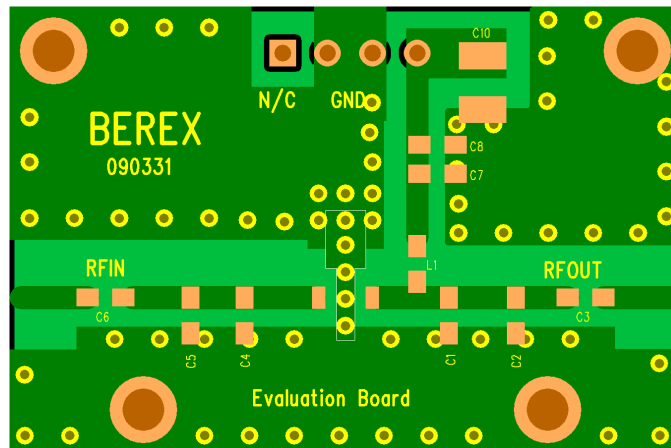

*Dielectric constant _ 4.2 *RF pattern width 52mil *31mil thick FR4 PCB

Typical Device Data

S-parameters (Vc=5V, Ic=100mA, T=25°C)

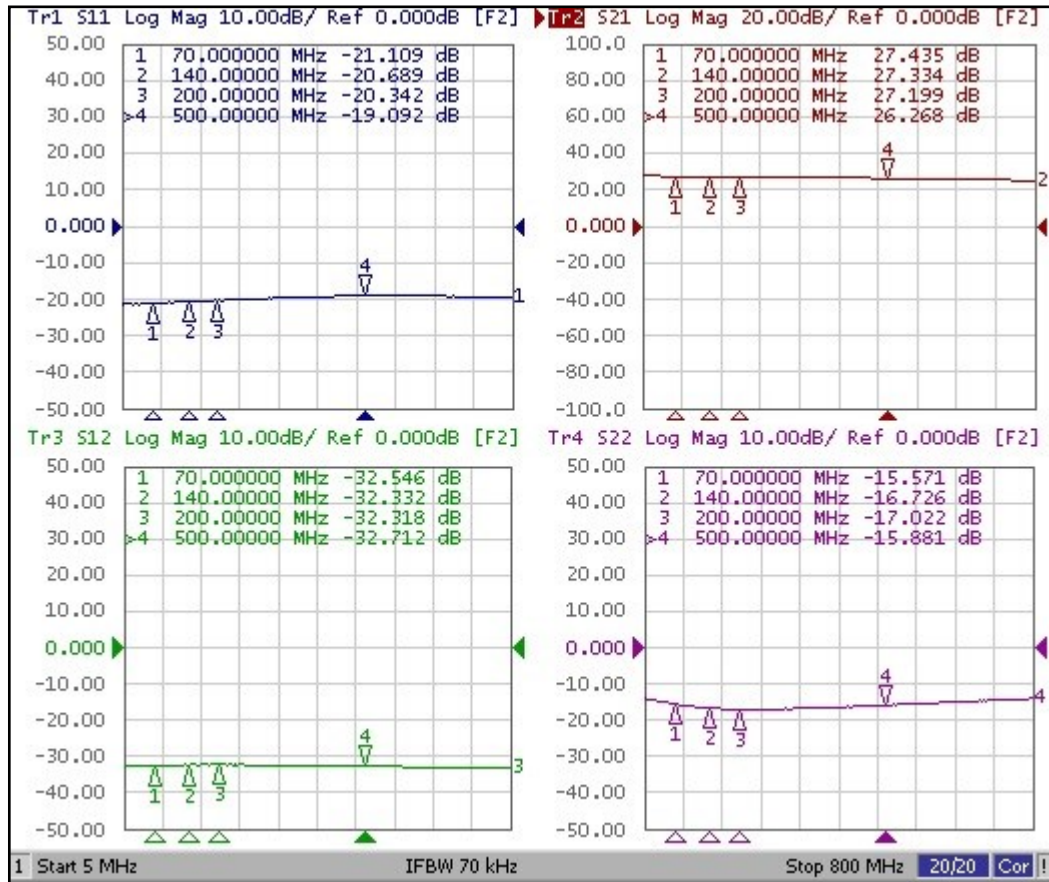

S-Parameter

(Vdevice = 5.0V, Icc = 100mA, T = 25 °C, calibrated to device leads)

Freq	S11 [Mag]	S11 [Ang]	S21 [Mag]	S21 [Ang]	S12 [Mag]	S12 [Ang]	S22 [Mag]	S22 [Ang]
100	0.09	-173.63	23.07	171.97	0.024	2.27	0.15	-22.65
200	0.10	-173.82	22.54	164.17	0.025	1.14	0.14	-29.49
300	0.10	-172.72	21.80	156.86	0.025	0.76	0.14	-36.27
400	0.11	-176.60	21.09	150.24	0.024	0.93	0.15	-41.05
500	0.11	179.34	20.27	144.05	0.024	1.25	0.15	-46.40
600	0.11	172.99	19.39	137.92	0.023	1.79	0.17	-51.58

Device Performance
 (Vd = 5V, Ic = 94mA, T = 25°C)

Pin-Pout-Gain

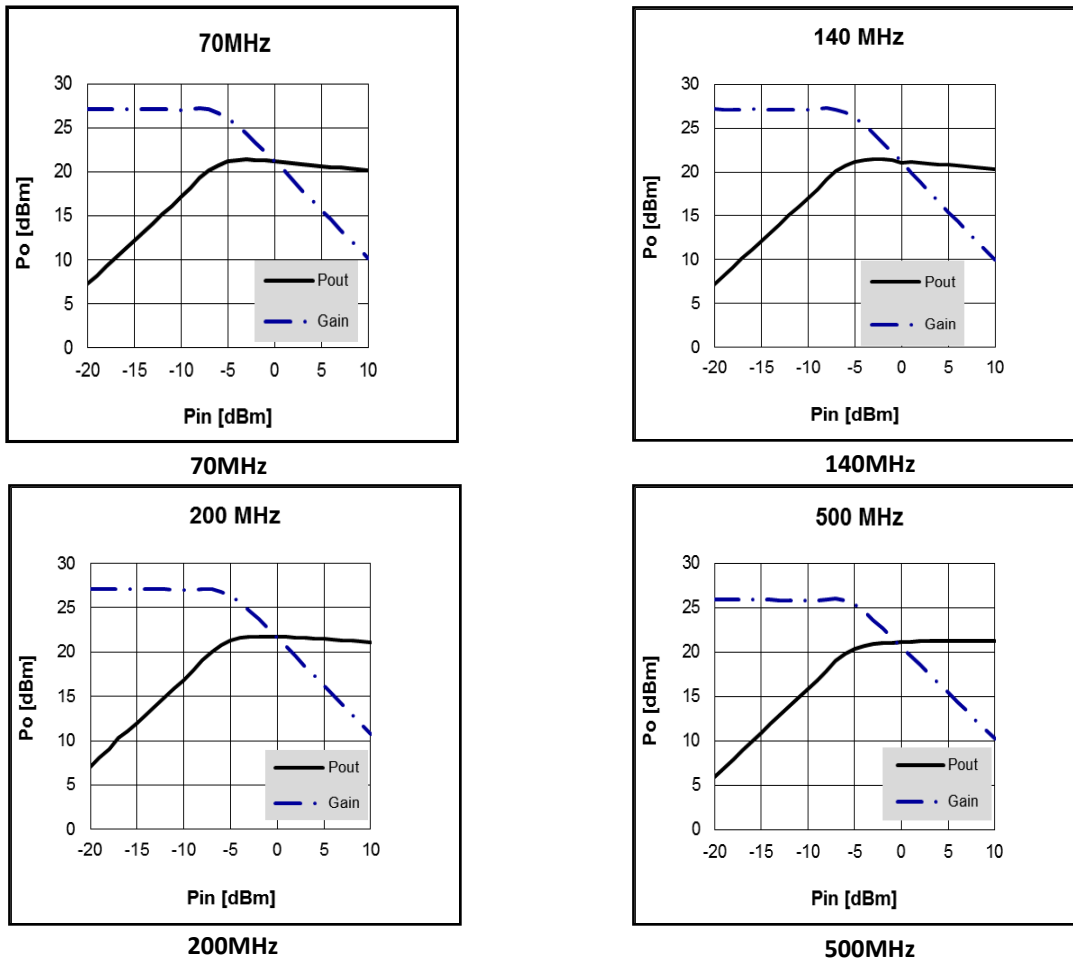

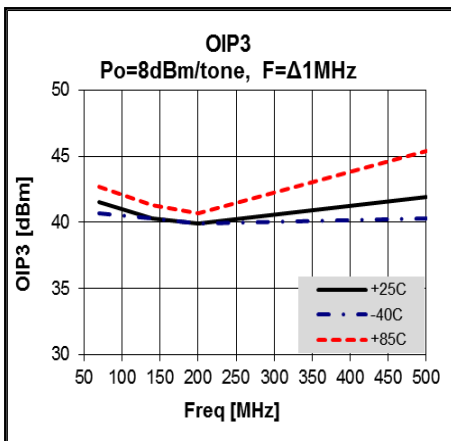
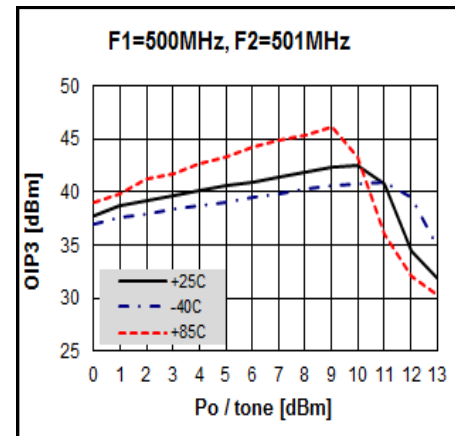
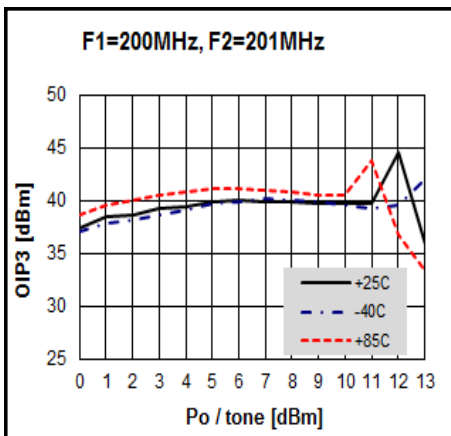
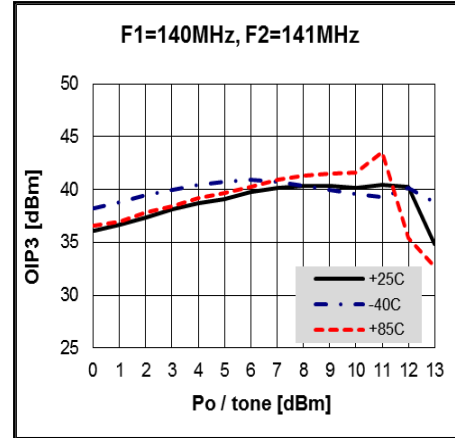
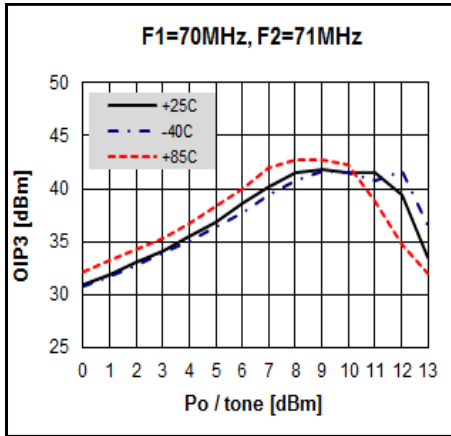
OIP3

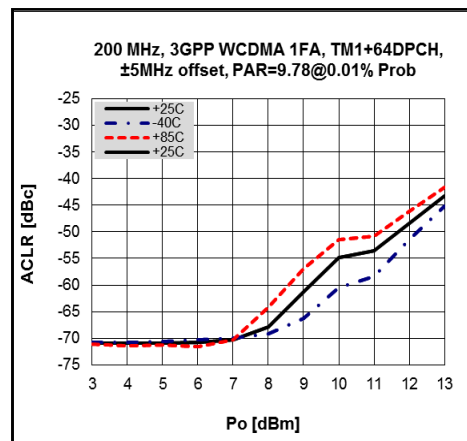
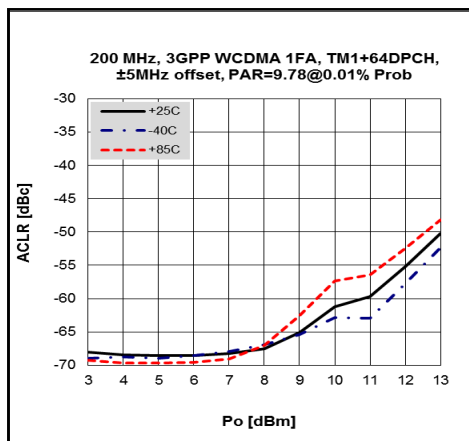
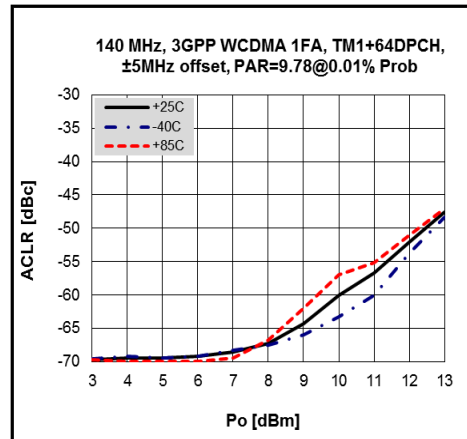
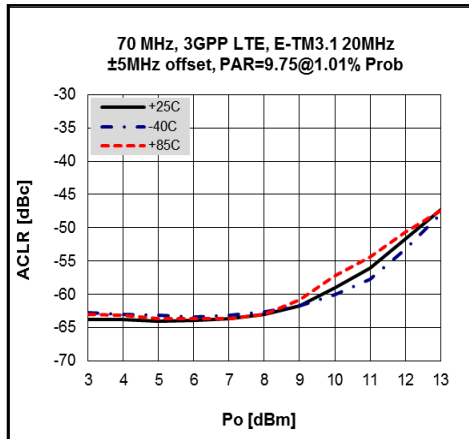
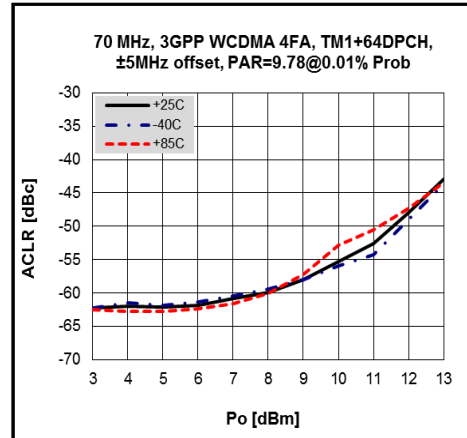
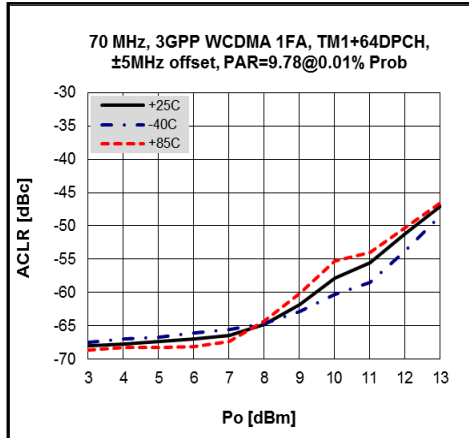
ACLR / LTE

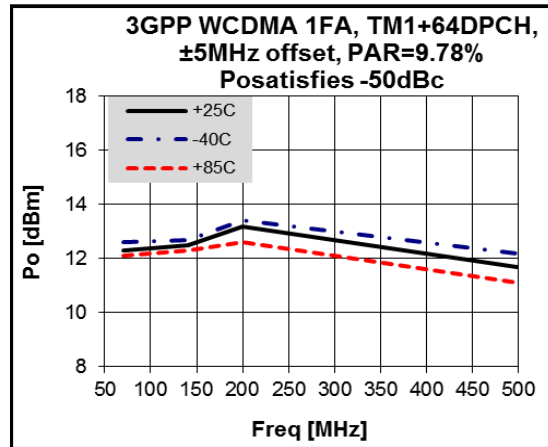

S-Parameters over Temperature (70MHz)

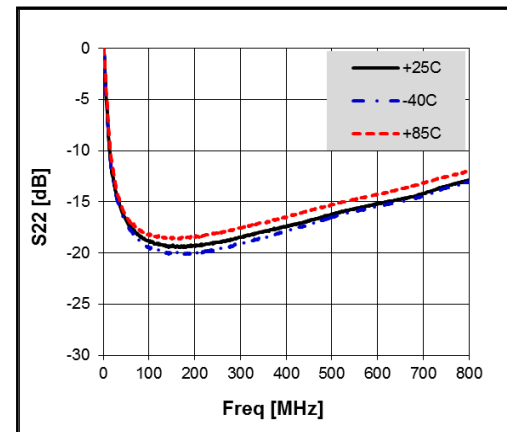
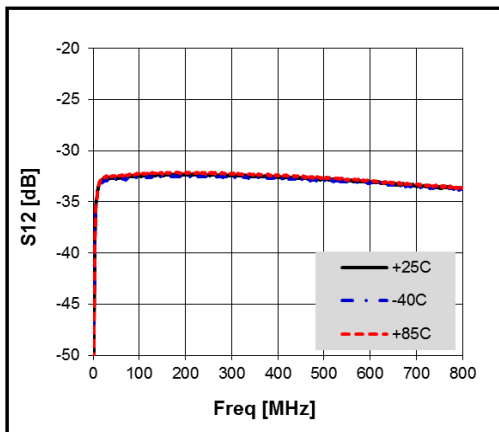
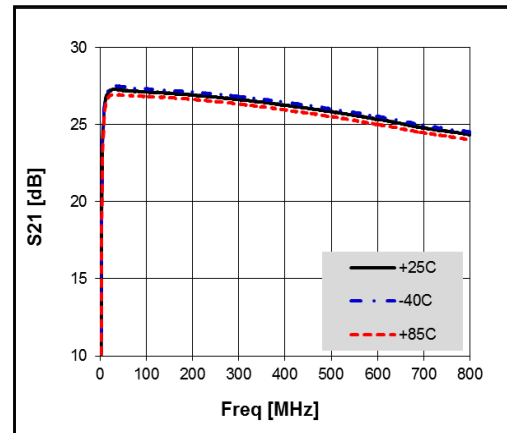
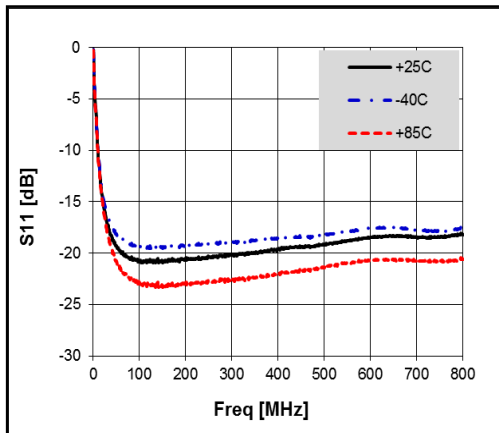

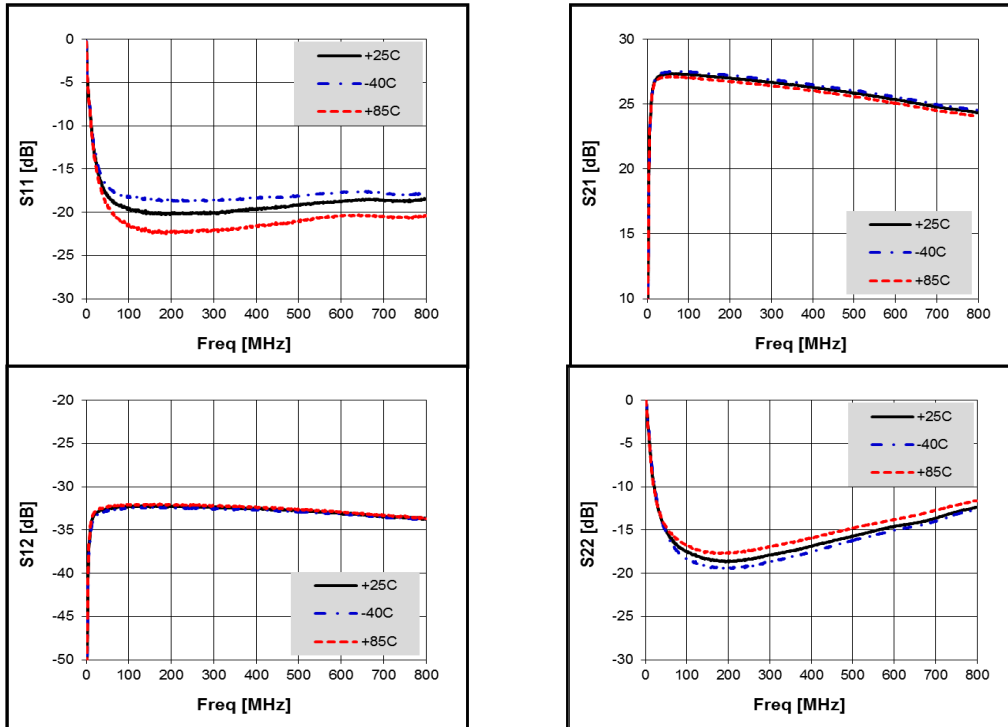
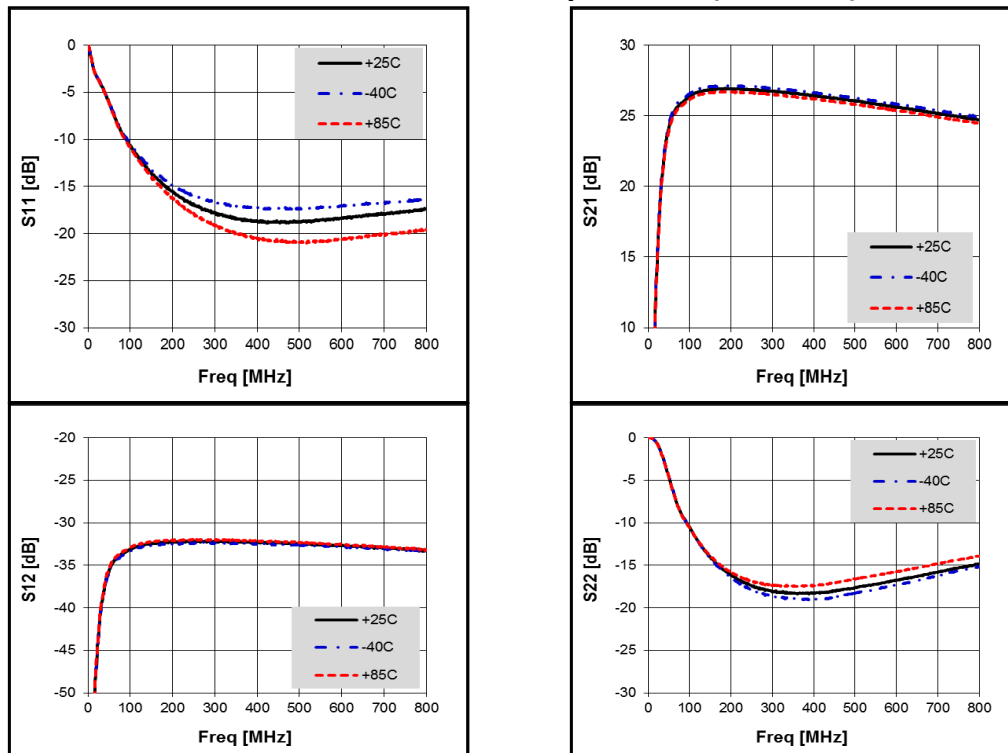
S-Parameters over Temperature (140MHz,200MHz)

S-Parameters over Temperature (500MHz)

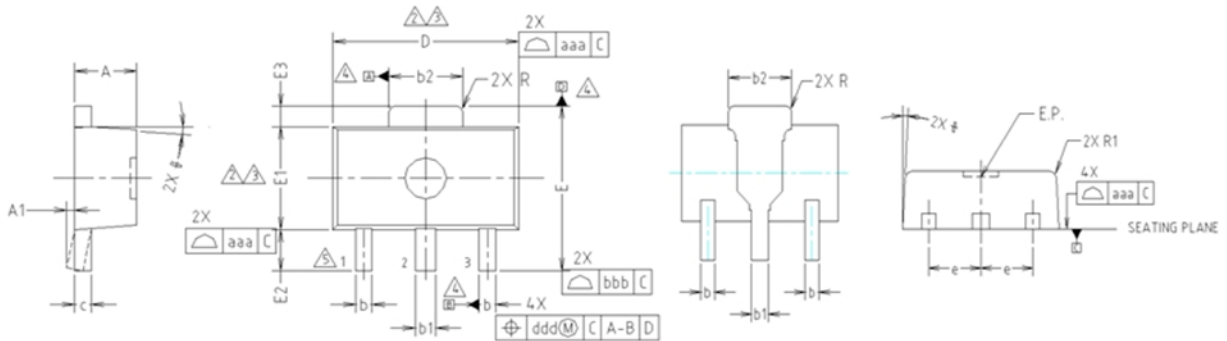
Package Outline Dimension



- NOTE:**
 1. DIMENSIONS IN MILLIMETERS.
- ⚠ DIMENSION D DOES NOT INCLUDE MOLD FLASH, PROTRUSIONS OR GATE BURRS. MOLD FLASH, PROTRUSIONS OR GATE BURRS SHALL NOT EXCEED 0.5mm PER END. DIMENSION E1 DOES NOT INCLUDE INTERLEAD FLASH OR PROTRUSION. INTERLEAD FLASH OR PROTRUSION SHALL NOT EXCEED 0.5mm PER SIDE.
 - ⚠ DIMENSIONS D AND E1 ARE DETERMINED AT THE OUTMOST EXTREMES OF THE PLASTIC BODY EXCLUSIVE OF MOLD FLASH, TIE BAR BURRS, GATE BURRS AND INTERLEAD FLASH, BUT INCLUDING ANY MISMATCH BETWEEN THE TOP AND BOTTOM OF THE PLASTIC BODY.
 - ⚠ DATUMS A, B AND D TO BE DETERMINED 0.18mm FROM THE LEAD TIP.
 - ⚠ TERMINAL NUMBERS ARE SHOWN FOR REFERENCE ONLY.

SYMBOL	MILLIMETERS			NOTE
	MINIMUM	NOMINAL	MAXIMUM	
A	1.40	1.50	1.60	
A1	0.00	—	0.10	
b	0.38	0.42	0.48	
b1	0.48	0.52	0.58	
b2	1.79	1.82	1.87	
c	0.40	0.42	0.46	
D	4.40	4.50	4.70	2,3
E	3.70	4.00	4.30	
E1	2.40	2.50	2.70	2,3
E2	0.80	1.00	1.20	
E3	0.40	0.50	0.60	
e	1.50 TYP.			
φ	4° TYP.			
R	0.15 TYP.			
R1	—	—	0.20	
SYMBOL	TOLERANCES OF FORM AND POSITION		NOTE	
aaa	0.15			
bbb	0.20			
ccc	0.10			
ddd	0.10			

Suggested PCB Land Pattern and PAD Layout

PCB Land Pattern

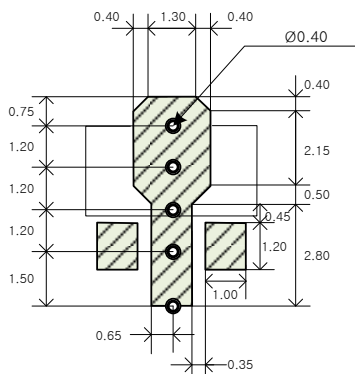

Note : All dimension _ millimeters

PCB lay out _ on BeRex website

PCB Mounting

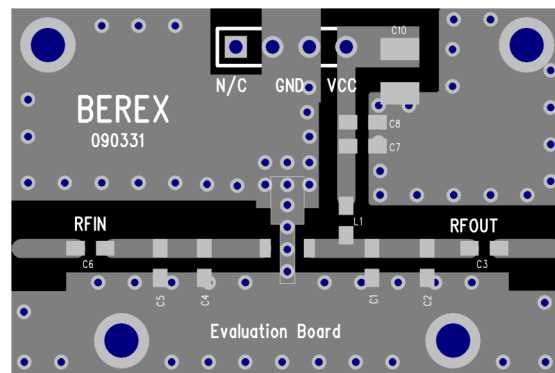

Package Marking

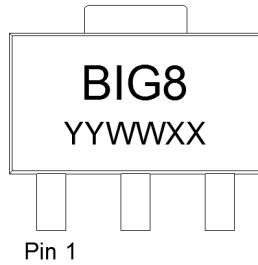

YY = Year, WW = Working Week,
XX = Wafer No.

Tape & Reel

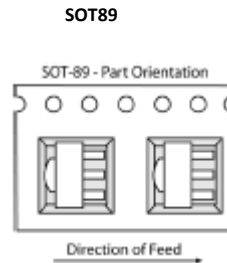

Packaging information:

Tape Width (mm): 12
Reel Size (inches): 7
Device Cavity Pitch (mm): 8
Devices Per Reel: 1000

Lead plating finish

100% Tin Matte finish

(All BeRex products undergoes a 1 hour, 150 degree C, Anneal bake to eliminate thin whisker growth concerns.)

MSL / ESD Rating

ESD Rating: Class 2
Value: Passes <4000V
Test: Human Body Model (HBM)
Standard: JEDEC Standard JS-001-2012

MSL Rating: Level 1 at +260°C convection reflow
Standard: JEDEC Standard J-STD-020



Proper ESD procedures should be followed when handling this device.

RoHS Compliance

This part is compliant with Restrictions on the Use of Certain Hazardous Substances in Electrical and Electronic Equipment (RoHS) Directive 2011/65/EU as amended by Directive 2015/863/EU.

This product also is compliant with a concentration of the Substances of Very High Concern (SVHC) candidate list which are contained in a quantity of less than 0.1%(w/w) in each components of a product and/or its packaging placed on the European Community market by the BeRex and Suppliers.

NATO CAGE code:

2	N	9	6	F
---	---	---	---	---