

Item description

Female connector/socket *WINSTA*® MIDI with protection type IP20

The *WINSTA*® MIDI female connector/socket with protection against mismatching is the pluggable solution for your application in control cabinets, on PCBs or for lighting connections. WAGO pluggable installation connectors are used when criteria repeat or are planned on a specified pattern, for example for installing grid lighting or flush-mount lighting. The coding options reduce installation errors, allowing fast, secure wiring of all components. The pluggable installation connector offers touch-proof protection with live components in accordance with protection type IP20 (When mated and secured with a strain relief housing: IP2xC (These compact connectors are not designed for use in open, easily accessible areas!)). Pluggable installation connectors with B coding from the *WINSTA*® MIDI line are available in pink, light green, or gray, allowing you to distinguish different circuits, for example for pumps, lighting, or sun blinds. Customer-specific pole marking is possible in addition. This pluggable installation connector can be used for a voltage load of up to 25 A. Thus, it can also be used for high power loads. *WINSTA*® MIDI with Push-in CAGE CLAMP® spring pressure connection technology is found in can be found in a variety of projects you can use for quick, easy, secure, tailored electrical installation.

Subject to changes. Please also observe the further product documentation!



Lower costs through fast commissioning and elimination of service expenses – solutions from WINSTA® MIDI

The WINSTA® Pluggable Connection System is perfectly tailored to the strict requirements of building installation. It makes electrical installation pluggable, and consequently faster, even more reliable, and error-free. Use of this pre-assembled system decreases time spent on assembly and errors during installation at the construction site. Choose durability and quality – the WINSTA® MIDI pluggable installation connector with marking from WAGO makes the installation of electrical components visibly easier.

- pluggable installation connectors with protection against mismatching
- simple circuits
- with B coding for controllers such as sun blinds and lighting fixtures
- custom-engineered solutions
- quick replacement of defective units during ongoing operation

Data

Notes

Variants:

Other pole markings

Other versions (or variants) can be requested from WAGO Sales or configured at <https://configurator.wago.com/>.

Electrical data

Ratings per IEC/EN

Ratings per	IEC/EN 60664-1
Nominal voltage (III/3)	400 V
Rated impulse voltage (III/3)	6 kV
Rated current	25 A
Note (rated current)	25 A for 3-pole load 20 A for 4- and 5-pole load
Legend (ratings)	(III / 3) ≙ Overvoltage category III / Pollution degree 3

Ratings per UL 1977

Note for the US market

Some versions may also be used for current interruption in accordance with the UL certificate in select applications with currents below 16 A and voltages up to 600 V. For further information, please contact your local sales office.

Rated voltage (UL 1977)	600 V
-------------------------	-------

Subject to changes. Please also observe the further product documentation!

WAGO GmbH & Co. KG

Hansastr. 27

32423 Minden

Phone: +49571 887-0 | Fax: +49571 887-169

Email: info.de@wago.com | Web: www.wago.com

Do you have any questions about our products?

We are always happy to take your call at +49 (571) 887-44222.



Rated current UL 1977

23 A

General

Note on contact resistance

approx. 1 mΩ of contact resistance
approx. 0.25 mΩ contact transition plug/socket

Connection data

Connection points

10

Total number of potentials

5

Connection 1

Connection technology

Push-in CAGE CLAMP®

Actuation type

Operating tool
Push-in

Nominal cross-section

4 mm² / 12 AWG

Solid conductor

0.5 ... 4 mm² / 20 ... 12 AWG

Solid conductor; push-in termination

1.5 ... 4 mm² / 16 ... 12 AWG

Stranded conductor

0.5 ... 2.5 mm² / 20 ... 14 AWG

Fine-stranded conductor

0.5 ... 4 mm² / 20 ... 12 AWG

Fine-stranded conductor; with insulated ferrule

0.25 ... 1.5 mm² / 20 ... 16 AWG

Fine-stranded conductor; with uninsulated ferrule

0.25 ... 2.5 mm² / 20 ... 14 AWG

Fine-stranded conductor; with ferrule; push-in termination

1.5 mm² / 16 AWG

Strip length

9 mm / 0.35 inches

Pole number

5

Conductor entry direction to mating direction

0°

Physical data

Pin spacing

10 mm / 0.394 inches

Width

50 mm / 1.969 inches

Height

12.9 mm / 0.508 inches

Depth

37.5 mm / 1.476 inches

Mechanical Data

Application

Control technology

Coding

B

Variable coding

Yes

Subject to changes. Please also observe the further product documentation!

WAGO GmbH & Co. KG

Hansastr. 27

32423 Minden

Phone: +49571 887-0 | Fax: +49571 887-169

Email: info.de@wago.com | Web: www.wago.com

Do you have any questions about our products?

We are always happy to take your call at +49 (571) 887-44222.



Marking	N ⚡ L1 L2 L3
Potential marking	N ⚡ L1 L2 L3
Mating force of a plug-in connection	approx. 20 ... 70 N (depending on pole number)
Retention force of a plug-in connection	Locked: > 80 N
Unmating force of a plug-in connection	Unlocked: approx. 20 ... 70 N (depending on pole number)
Number of mating cycles	200, without resistive load
Protection type	IP20; When mated and secured with a strain relief housing: IP2xC (These compact connectors are not designed for use in open, easily accessible areas!)

Plug-in connection

Contact type (pluggable connector)	Female connector/socket
Connector (connection type)	for conductor
Mismating protection	Yes
Note on mismating protection	All <i>WINSTA</i> [®] components are 100% protected against mismating when: a.) plugging different numbers of poles b.) plugging while rotated 180 c.) plugging while laterally staggered d.) plugging one pole
Locking lever	Can be retrofitted
Locking of plug-in connection	locking lever
Note on locking system	All connectors for mounted installations (snap-in versions for lighting fixtures or devices, all types of PCB and distribution connectors) are factory-equipped with locking levers to ensure plugs and sockets are securely locked. Additional locking levers are only required for flying leads (plug/socket).

Material Data

Note (material data)	Information on material specifications can be found here
Color	gray
Cover color	gray
Material group	I
Insulation material	Polyamide (PA66)
Flammability class per UL94	V0
Clamping spring material	Chrome-nickel spring steel (CrNi)
Contact material	Copper or copper alloy; surface-treated
Contact plating	Tin

Subject to changes. Please also observe the further product documentation!

Fire load	0.407 MJ
Weight	16.1 g

Environmental requirements

Processing temperature	-5 ... +40 °C
Continuous operating temperature	-35 ... +85 °C
Note on continuous operating temperature	Insulating parts for temperatures ≤ 105 °C

Commercial data

eCl@ss 10.0	27-44-06-05
eCl@ss 9.0	27-44-06-05
ETIM 8.0	EC002560
ETIM 7.0	EC002560
PU (SPU)	50 pcs
Packaging type	box
Country of origin	DE
GTIN	4050821553649
Customs tariff number	85366990990

Environmental Product Compliance

RoHS Compliance Status	Compliant, No Exemption
------------------------	-------------------------

Approvals / Certificates

General approvals

Logo	Approval	Additional Approval Text	Certificate name
	cURus Underwriters Laboratories Inc.	UL 1977	E45171

Counterpart



Item no. 770-255/060-000

Plug; 5-pole; Cod. B; 4,00 mm²; graywww.wago.com/770-255/060-000

Subject to changes. Please also observe the further product documentation!



Item no.770-755/060-000
Snap-in plug; 5-pole; Cod. B; 4,00 mm²; gray

www.wago.com/770-755/060-000



Item no.770-855/011-000/060-000
Plug for PCBs; angled; 5-pole; Cod. B; gray

www.wago.com/770-855/011-000/060-000



Item no.770-855/060-000
Plug for PCBs; straight; 5-pole; Cod. B; gray

www.wago.com/770-855/060-000

Required accessories

Locking levers

Locking system



Item no.: 770-121
Locking lever; for flying leads; for manual operation; white

www.wago.com/770-121



Item no.: 770-131
Locking lever; for flying leads; for tool operation; white

www.wago.com/770-131



Item no.: 770-101
Locking lever; for flying leads; for manual operation; black

www.wago.com/770-101



Item no.: 770-111
Locking lever; for flying leads; for tool operation; black

www.wago.com/770-111

Strain relief

Strain relief housing



Item no.: 770-505/021-000
Strain relief housing; 5-pole; for 1 cable; 11.5 ... 16.5 mm; 71 mm; black

www.wago.com/770-505/021-000



Item no.: 770-505/023-000
Strain relief housing; 5-pole; for 2 cables; 5.0 ... 9.0 mm; 55 mm; black

www.wago.com/770-505/023-000



Item no.: 770-505
Strain relief housing; 5-pole; for 2 cables; 9.0 ... 13.0 mm; 55 mm; black

www.wago.com/770-505

Subject to changes. Please also observe the further product documentation!



Item no.: 770-515

Strain relief housing; 5-pole; for 2 cables; 9.0 ... 13.0 mm; 55 mm; white

www.wago.com/770-515



Item no.: 770-515/023-000

Strain relief housing; 5-pole; for 2 cables; 5.0 ... 9.0 mm; 55 mm; white

www.wago.com/770-515/023-000



Item no.: 770-515/021-000

Strain relief housing; 5-pole; for 1 cable; 11.5 ... 16.5 mm; 71 mm; white

www.wago.com/770-515/021-000

Optional accessories

Cover

Cover



Item no.: 770-201

Lockout cap; 12-pole, separable; for sockets; Plastic; black

www.wago.com/770-201



Item no.: 770-221

Lockout cap; 12-pole, separable; for sockets; Plastic; white

www.wago.com/770-221



Item no.: 897-2005

Protective cap; Type4; for sockets and plugs; PVC; red

www.wago.com/897-2005

Mounting

Snap-in frame



Item no.: 770-320

Snap-in frame; 5-pole; 1.0 ... 3.0 mm; black

www.wago.com/770-320



Item no.: 770-321

Snap-in frame; 5-pole; 0.5 ... 2.0 mm; black

www.wago.com/770-321



Item no.: 770-340

Snap-in frame; 5-pole; 1.0 ... 3.0 mm; white

www.wago.com/770-340

Subject to changes. Please also observe the further product documentation!

WAGO GmbH & Co. KG

Hansastr. 27

32423 Minden

Phone: +49571 887-0 | Fax: +49571 887-169

Email: info.de@wago.com | Web: www.wago.com

Do you have any questions about our products?

We are always happy to take your call at +49 (571) 887-44222.



Item no.: 770-341

Snap-in frame; 5-pole; 0.5 ... 2.0 mm; white

Marking accessories

Marker



Item no.: 770-450/000-002

Marker card; Plastic; yellow

www.wago.com/770-450/000-002



Item no.: 770-450/000-001

Marker card; Plastic; green

www.wago.com/770-450/000-001



Item no.: 770-450/000-005

Marker card; Plastic; red

www.wago.com/770-450/000-005



Item no.: 770-450

Marker card; Plastic; white

www.wago.com/770-450



Item no.: 770-450/000-006

Marker card; Plastic; blue

www.wago.com/770-450/000-006



Item no.: 770-450/000-012

Marker card; Plastic; orange

www.wago.com/770-450/000-012

Tool

Operating tool



Item no.: 210-719

Operating tool; Blade: 2.5 x 0.4 mm; with a partially insulated shaft

www.wago.com/210-719

Downloads

Documentation

Bid Text

770-245/060-000

2019 Feb 19

xml

Download

Subject to changes. Please also observe the further product documentation!

WAGO GmbH & Co. KG

Hansastr. 27

32423 Minden

Phone: +49571 887-0 | Fax: +49571 887-169

Email: info.de@wago.com | Web: www.wago.com

Do you have any questions about our products?

We are always happy to take your call at +49 (571) 887-44222.



X81 - Datei			3.0 kB	
770-245/060-000	2015 Jun 8	doc		Download
doc - Datei		24.6 kB		

CAD/CAE-Data

CAD data

2D/3D Models 770-245/060-000		URL	Download
------------------------------	--	-----	----------

CAE data

WSCAD Universe 770-245/060-000		URL	Download
ZUKEN Portal 770-245/060-000		URL	Download
WSCAD Universe 770-245/060-000		URL	Download

Environmental Product Compliance

Compliance Search

Environmental Product Compliance 770-245/060-000		URL	Download
Socket; 5-pole; Cod. B; 4,00 mm ² ; gray			

Installation Notes

Conductor termination

Subject to changes. Please also observe the further product documentation!

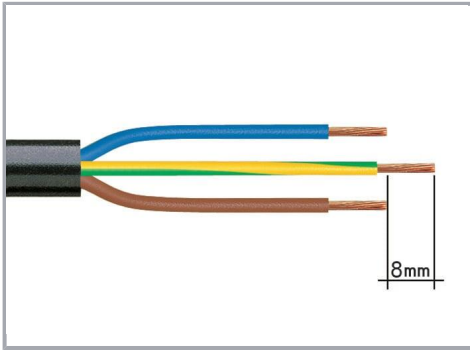

1. Strip length, outer insulation = 35 mm (2-pole), 55 mm (3- to 5-pole)

2. Strip length = 9 mm

3. Extended ground conductor = 8 mm

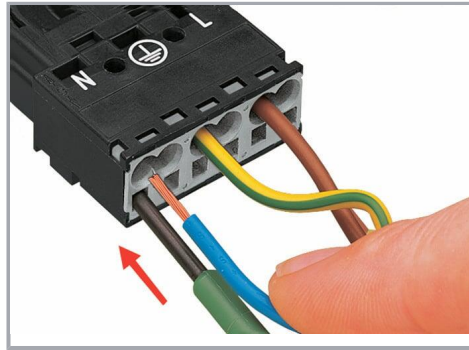

To terminate fine-stranded conductors, open the clamping unit via screwdriver (2.5 mm blade width) and insert a stripped conductor until it hits the backstop.

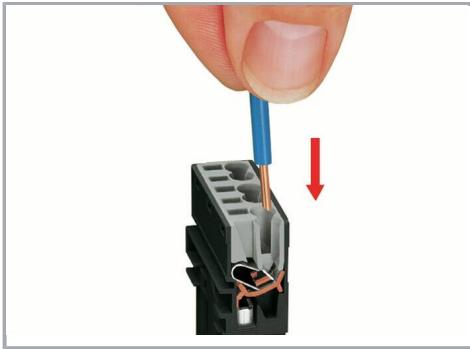

Insert the stripped solid conductor until it hits the backstop.

Subject to changes. Please also observe the further product documentation!

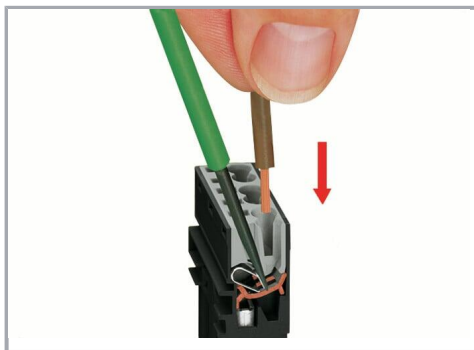

To terminate fine-stranded conductors, open the clamping unit via screwdriver (2.5 mm blade width) and insert a stripped conductor until it hits the backstop.

Conductor removal

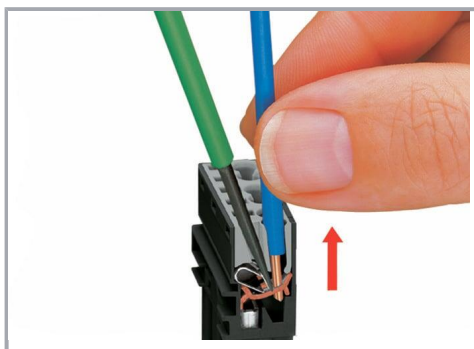

To remove the conductor, actuate the clamp via screwdriver (2.5 mm blade width) and pull out the conductor.

Installation

Subject to changes. Please also observe the further product documentation!

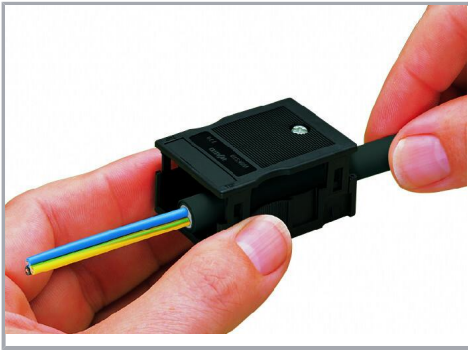

We recommend pulling the pre-latched strain relief housing over the cable prior to termination. However, the strain relief can be mounted at a later time as well.

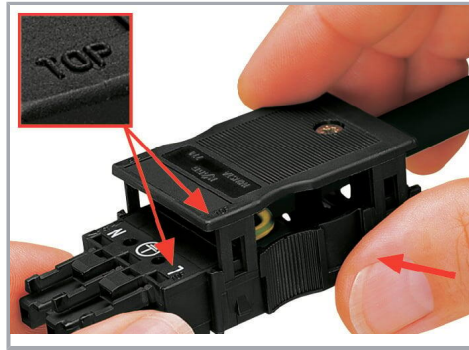

Latch the strain relief housing onto the plug /socket. Note the "TOP" inscription.

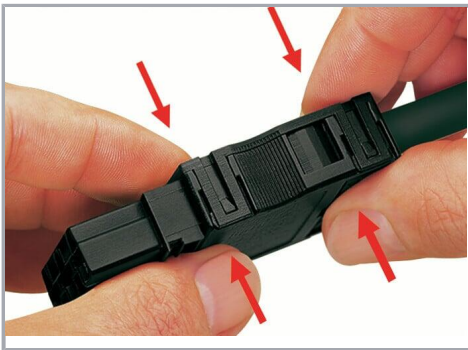

Prepare strain relief housing by snapping together upper and bottom part.



Tighten strain relief screw with screwdriver (2.5 mm blade width).

Coding



Simply cut off the coding pin from the socket.

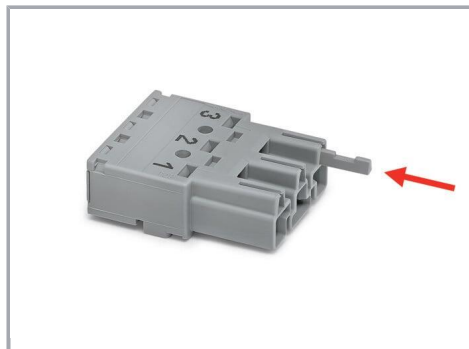

Insert coding pin into plug (break first) until it engages.

Subject to changes. Please also observe the further product documentation!

Mismatching protection

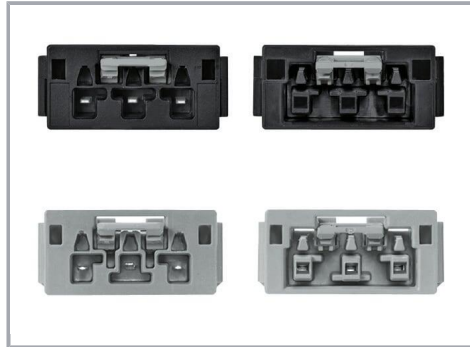
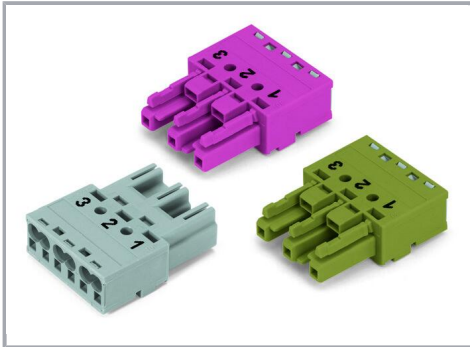

B-coded connectors with different colors can be plugged together.

Important note:

Different colors and/or pole markings are used for circuit identification.

Only connectors of the same color and same pole marking must be plugged together.

B-coded connectors (shown in gray) not only differ in color, but also in their design, making them incompatible with other coded connectors.



Easy circuit identification via different marking and colors

Product family

WINSTA® MIDI

[Show all products from the family](#)

Subject to changes. Please also observe the further product documentation!