

Kit Number **YH800-2p-180-50m-A**

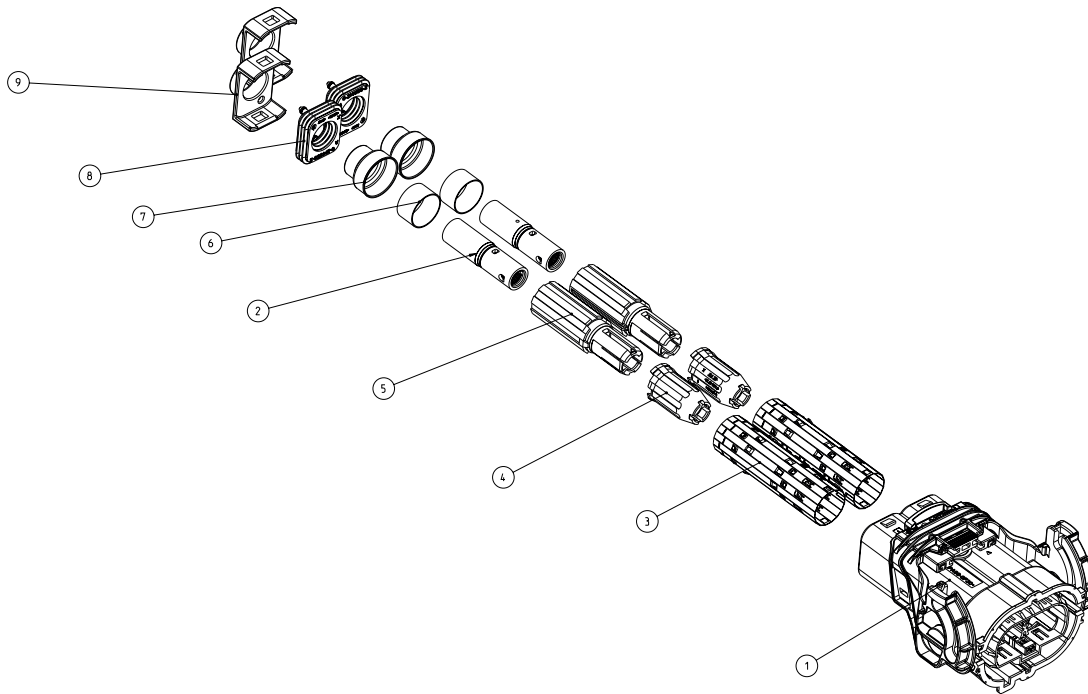

AMP+ High Current Connectors and Headers

AMP+ HVP800



Connector Series **AMP+ HVP800**

Positions	2
Cable Size	50 mm ²
Connector Orientation	180°
Wire Type	Individually Shielded
HVIL	Bridged in the connector
Key Coding	A
Application Specification	114-94130
Product Specification	108-94297
Mating Header PN	2141227-1

Bill of Materials

Item No	Part Number	Description	Quantity
①	1-2177053-1	2Pos, Rec Hsg 180° Assy, Key A	1
②	2177592-1	Turned contact, 50 mm ² , 180°, Assy	2
③	2177060-3	Shielding Sleeve, 180°	2
④	2177059-1	Finger Protection Cap, 180°	2
⑤	2177058-1	Insulation insert, 180°	2
⑥	2177061-1	Inner crimp ferrule, 180°	2
⑦	2177090-1	Shield crimp ferrule, 180°	2
⑧	2141156-1	Single wire seal	2
⑨	2141155-1	Cover, seal	2

DISCLAIMER

While TE Connectivity (TE) has made every reasonable effort to ensure the accuracy of the information in this document, TE does not guarantee that it is error-free, nor does TE make any other representation, warranty or guarantee that the information is accurate, correct, reliable or current. TE reserves the right to make any adjustments to the information contained herein at any time without notice.

TE expressly disclaims all implied warranties regarding the information contained herein, including, but not limited to, any implied warranties of merchantability or fitness for a particular purpose. The dimensions in this catalog are for reference purposes only and are subject to change without notice. Specifications are subject to change without notice. Consult TE for the latest dimensions and design specifications.

TRADEMARKS

AMP+, TE, TE Connectivity, and TE connectivity (logo) are trademarks.

Other product names, logos, and company names mentioned herein may be trademarks of their respective owners.

COPYRIGHT

© 2019 TE Connectivity | All rights reserved.

5-1773982-8 | 09-2019

CONTACT

TE Connectivity

4849 Hempstead Station Drive | Kettering, OH 45429 | USA

Phone: +1 800 522 6752