

SPECIFICATIONS **CS85BG1C**

PACKAGE DIMENSION

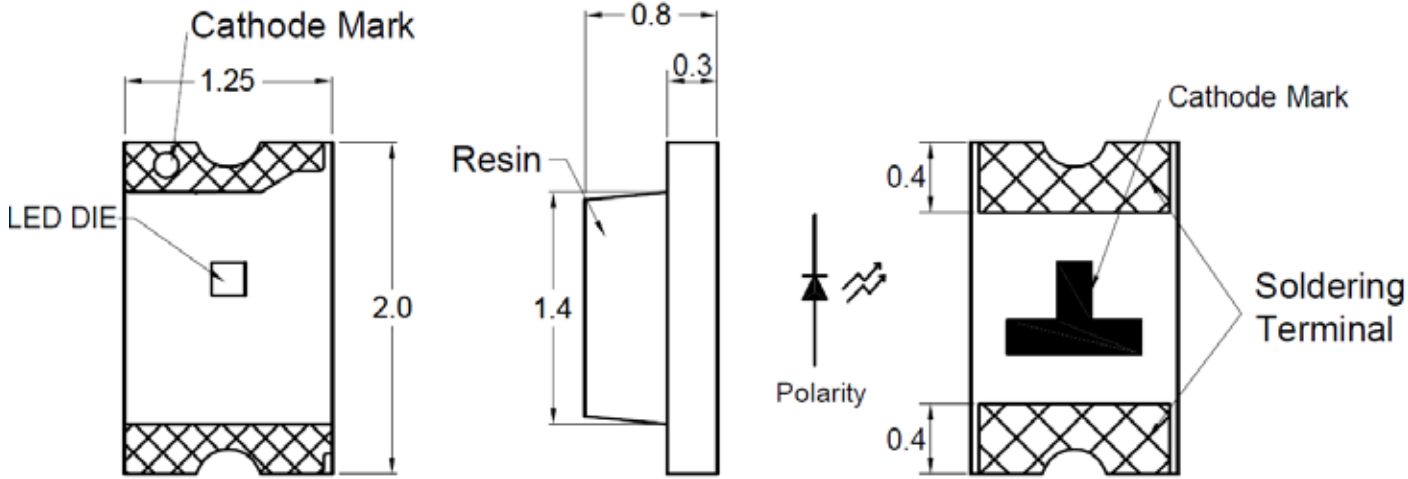

Recommended Solder Pad

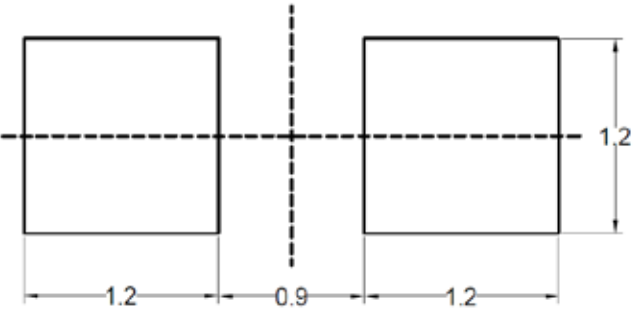

Notes:
 1. All dimensions are in millimeters (inches);
 2. Tolerances are ±0.1mm unless otherwise noted.

Part Number	Chip Material	Color of Emission	Lens Type	Viewing Angle
CS85BG1C	GaP	Green	Water Clear	160°



ChromeLED Corp. reserves the right to make changes at any time in order to supply the best product possible. The most current version of this document will always be available at: www.chromeled.com

ABSOLUTE MAXIMUM RATINGS
(TA=25°C)

Parameter	Symbol	Value	Unit
Forward current	I _f	25	mA
Reverse current @ 5V	I _r	10	μA
Power dissipation	P _d	65	mW
Operating temperature range	T _{op}	-40~+85	°C
Storage temperature range	T _{stg}	-40~+90	°C
Peak pulsing current (1/10 duty f= 10KHz)	I _{fp}	120	mA
Soldering Temperature	T _{SOL}	Max 260°C for 5 sec Max	

OPTICAL-ELECTRICAL CHARACTERISTICS
(TA=25°C)

Parameter	Symbol	Test Condition	Value			Unit
			Min	Typ	Max	
Wavelength at peak emission	λ _{peak}	I _F = 20mA	-	565	-	nm
Spectral half bandwidth	Δλ	I _F = 20mA	-	30	-	nm
Dominant wavelength	λ _{dom}	I _F = 20mA	566	573	576	nm
Forward Voltage	V _f	I _F = 20mA	1.5	-	2.4	V
Luminous intensity	I _v	I _F = 20mA	5.0	10	-	mcd
Viewing angle at 50% I _v	2θ ½	I _F = 20mA		160	-	Deg

*NOTE: 1. The forward voltage data did not including ±0.1V tolerance 2. The luminous intensity data did not including ±15% tolerance



ChromeLED Corp. reserves the right to make changes at any time in order to supply the best product possible. The most current version of this document will always be available at: www.chromeled.com

DIMENSIONS OF TAPE (Unit: mm)

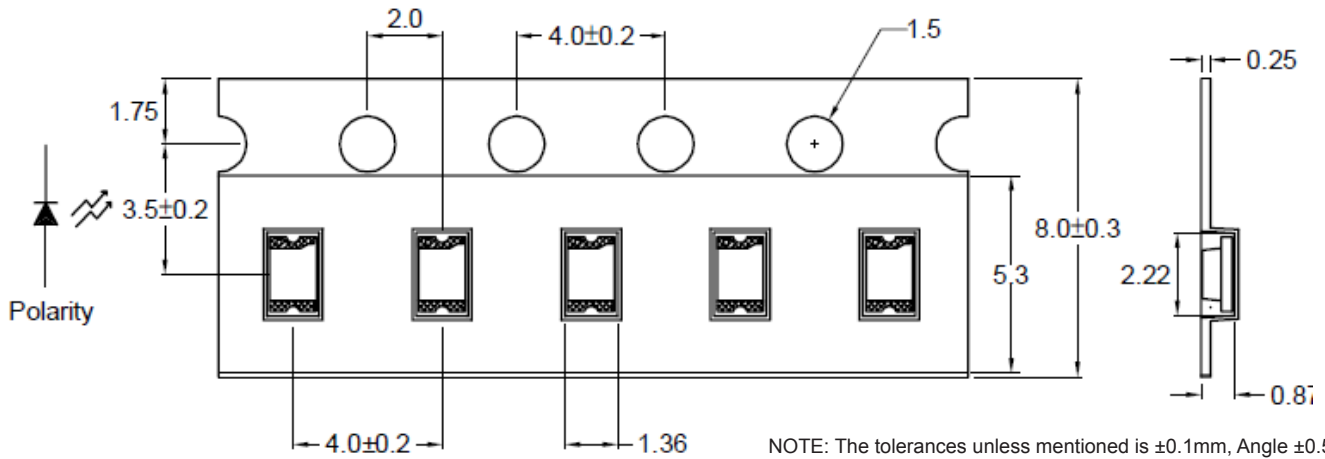

REEL DIMENSIONS

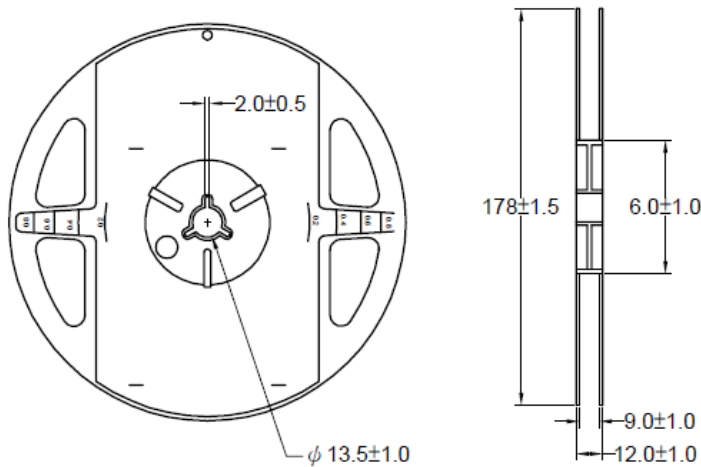

- NOTES:
1. Empty component pockets are sealed with top cover tape;
 2. The maximum number of missing lamps is two;
 3. The cathode is oriented towards the tape sprocket hole.
 4. 4,000pcs/Reel

PACKAGING SPECIFICATION

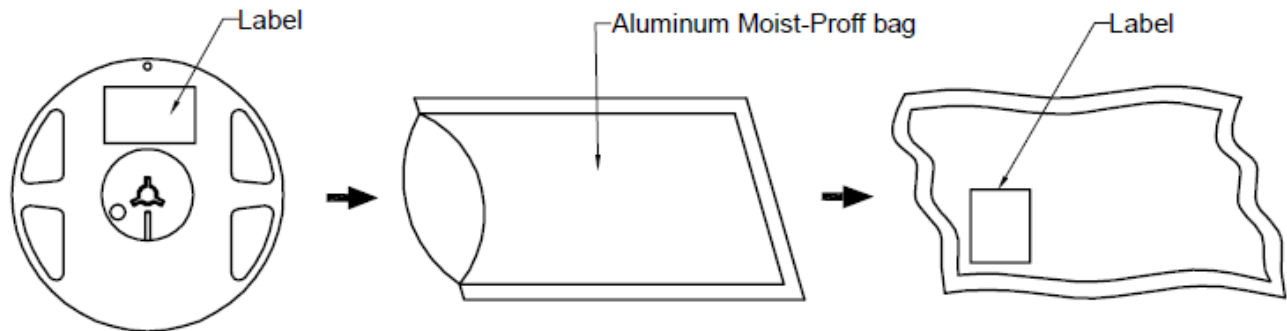

ChromeLED Corp. reserves the right to make changes at any time in order to supply the best product possible. The most current version of this document will always be available at: www.chromeled.com

OPTICAL CHARACTERISTIC CURVES

Fig.1 Forward current vs. Forward Voltage

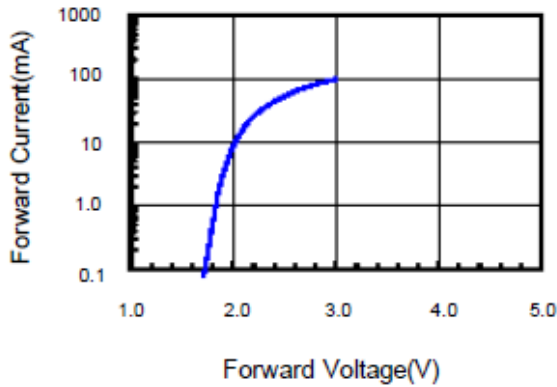

Fig.2 Relative Intensity vs. Forward Current

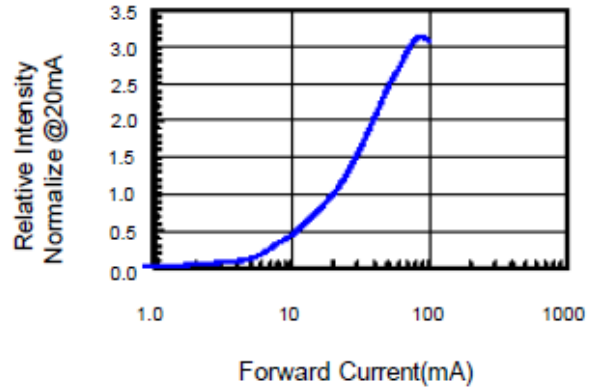

Fig.3 Forward Voltage vs. Temperature

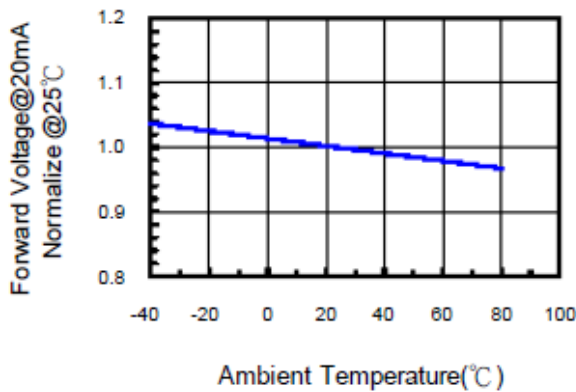

Fig.4 Relative Intensity vs. Temperature

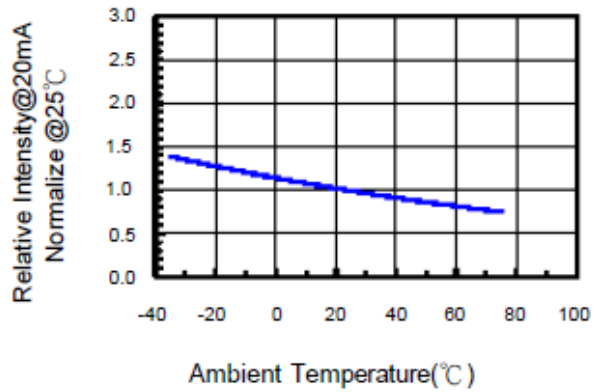

Fig.5 Relative Intensity vs. Wavelength

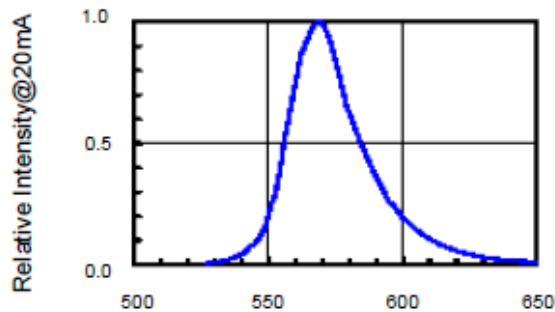
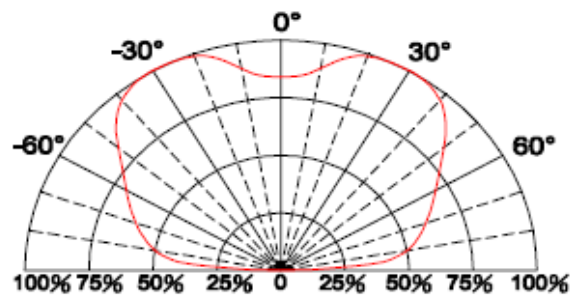

Fig.6 Directive Radiation



ChromeLED Corp. reserves the right to make changes at any time in order to supply the best product possible. The most current version of this document will always be available at: www.chromeled.com

SOLDERING CONDITIONS – LAMP TYPE LED

1. Hand Solder

Basic spec is $\leq 280^{\circ}\text{C}$ 3 sec one time only.

2. Wave Solder

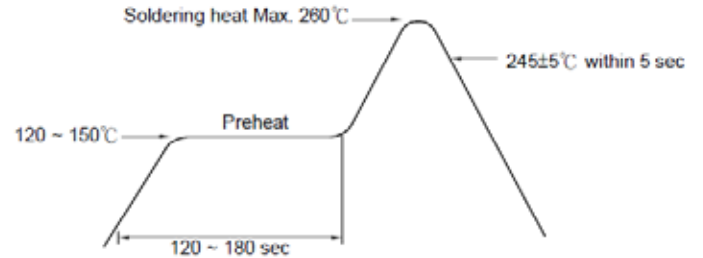

3-1. LEAD Reflow Solder

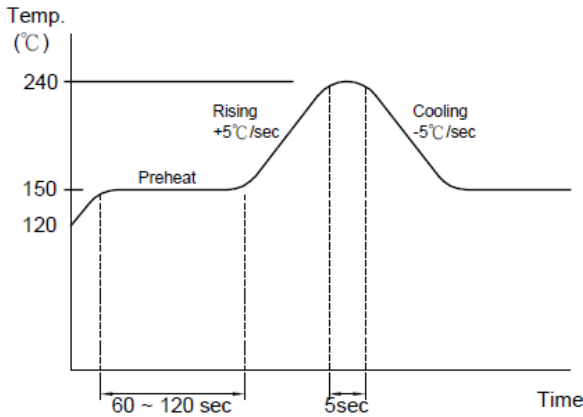

3-2 PB-Free Reflow Solder

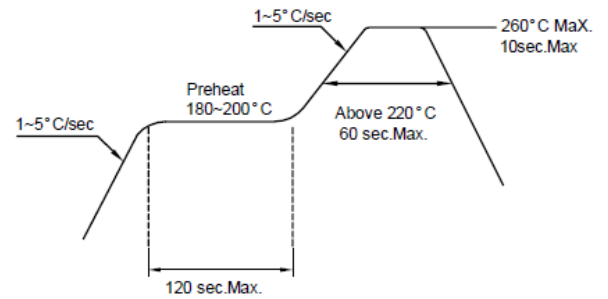

Reflow Soldering should not be done more than two times.

Brighness Code for Visible SMD

Group	(mcd) at 20mA	
	MIN	MAX
J	5	8
K	8	12.5
L	12.5	20

Color Code for Visible SMD

Group	(mcd) at 20mA	
	MIN	MAX
6	566	568
7	568	570
8	570	572
9	572	574
10	574	576



ChromeLED Corp. reserves the right to make changes at any time in order to supply the best product possible. The most current version of this document will always be available at: www.chromeled.com