



# ATWINC15x0 Smart Device Kit

## Wi-Fi® Smart Device Enablement Kit User Guide

### Introduction

The Wi-Fi Smart Device Enablement Kit is a small and easy demonstration and development platform for Internet of Things (IoT) solutions. It is designed to demonstrate the design of typical IoT applications.

The kit is controlled by a SAML21G18B host MCU. It is equipped with an ATWINC15x0 IEEE® 802.11 b/g/n network controller, an ATECC608A CryptoAuthentication™ device, an MCP73833 Li-Ion/Li-Po charge management controller, a MIC5317 High PSRR LDO, BME280 environment sensor and VEML6030 light sensor. It can be programmed and debugged with an Atmel-ICE programmer through SWD interface or programmed with an SAM-BA® in-system programmer through USB interface.

The Wi-Fi Smart Device Enablement Kit is pre-programmed and configured for demonstrating connectivity to the AWS® IoT cloud, working with Amazon Alexa®. The user can speak to an Alexa-enabled device (for example, Echo Dot®) to get the sensor data and control LED of the kit. A mobile application is provided for board registration and network configuration. It can be used to monitor and control the kit. As an IoT edge, this firmware provides the control, monitoring, Wi-Fi connectivity and security functions in a typical IoT scenario.

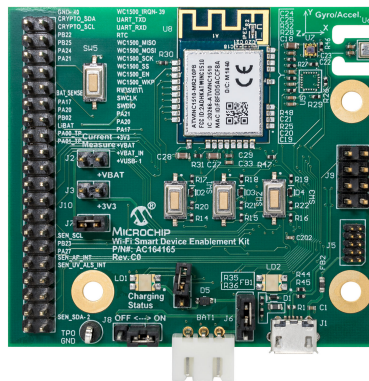

This board is used for evaluation/demonstration purposes only.

## Table of Contents

Introduction .....	1
1. Overview.....	4
1.1. Hardware .....	4
1.1.1. Components.....	4
1.1.2. Block Diagram.....	4
1.1.3. Board Layout.....	5
1.1.4. Power Supply.....	6
1.1.5. Schematic.....	9
1.2. Application .....	9
1.2.1. Features.....	9
1.2.2. Board Operation .....	9
1.2.3. LED Indicators .....	10
1.2.4. Buttons.....	11
1.2.5. AWS Provision with ECC608.....	11
1.2.6. MCU Firmware .....	12
1.2.7. Mobile Application.....	12
2. Getting Started.....	13
2.1. Set Up the Board with Android App.....	13
2.1.1. Create a User Account.....	13
2.1.2. Register the Board.....	14
2.1.3. Control the Board.....	19
2.2. Set Up the Board with iOS App.....	20
2.2.1. Create a User Account.....	20
2.2.2. Register the Board.....	22
2.2.3. Control the Board.....	27
2.3. Enable Amazon Alexa on the Board.....	28
2.3.1. Set up Alexa on Amazon Echo Dot.....	29
2.3.2. Enable Microchip Wi-Fi Smart Device Smart Home Skill.....	29
2.3.3. Enable Microchip Sensor Board Skill.....	35
2.3.4. Control and Monitor the Wi-Fi Smart Device Enablement Kit Using Voice Commands with Echo Dot.....	37
3. Board Development.....	39
4. Board Debugging.....	40
4.1. UART Debug Interface.....	40
4.2. Install a Terminal Emulator.....	40
5. Design Documents and Related Links .....	42
6. Document Revision History .....	43
The Microchip Web Site.....	44

Customer Change Notification Service.....	44
Customer Support.....	44
Microchip Devices Code Protection Feature.....	44
Legal Notice.....	45
Trademarks.....	45
Quality Management System Certified by DNV.....	46
Worldwide Sales and Service.....	47

## 1. Overview

### 1.1 Hardware

This section describes the hardware details of the Wi-Fi Smart Device Enablement Kit.

#### 1.1.1 Components

- Host MCU – ATSAML21G18B (Ultra-low power microcontroller, 40 KB RAM, 256 KB program memory)
- Wi-Fi network controller – ATWINC1510 module
- Power – Rechargeable 2000 mAh Lithium Battery or USB
- Crypto IC – ECC608
- User interface – Three buttons and one RGB LED
- Program/Debug interface – SWD
- Sensor
  - Light sensor (VEML6030)
  - Environment sensor (BME280)
    - Temperature
    - Humidity
    - Pressure

#### 1.1.2 Block Diagram

The board is designed to be powered by rechargeable lithium battery or USB interface. The central part of the board is the SAML21G18B MCU, which controls all the other devices in this board. The ATWINC15x0 network controller module provides Wi-Fi and network capabilities. The ATECC608A is responsible for the certificate storage and authentication. An environment sensor, LED and button are used for demo purposes.

**Figure 1-1. Block Diagram**

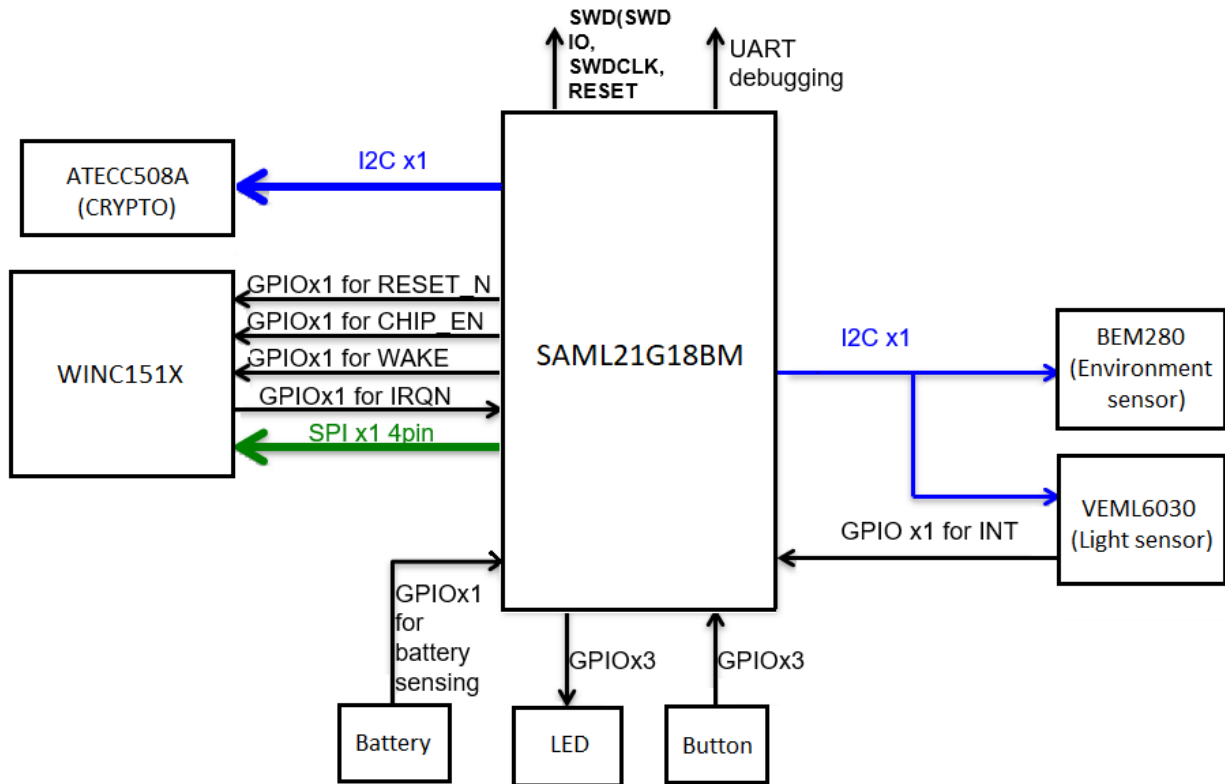

### 1.1.3 Board Layout

The following are the top and bottom side layout of the board.

**Figure 1-2. Top Side**

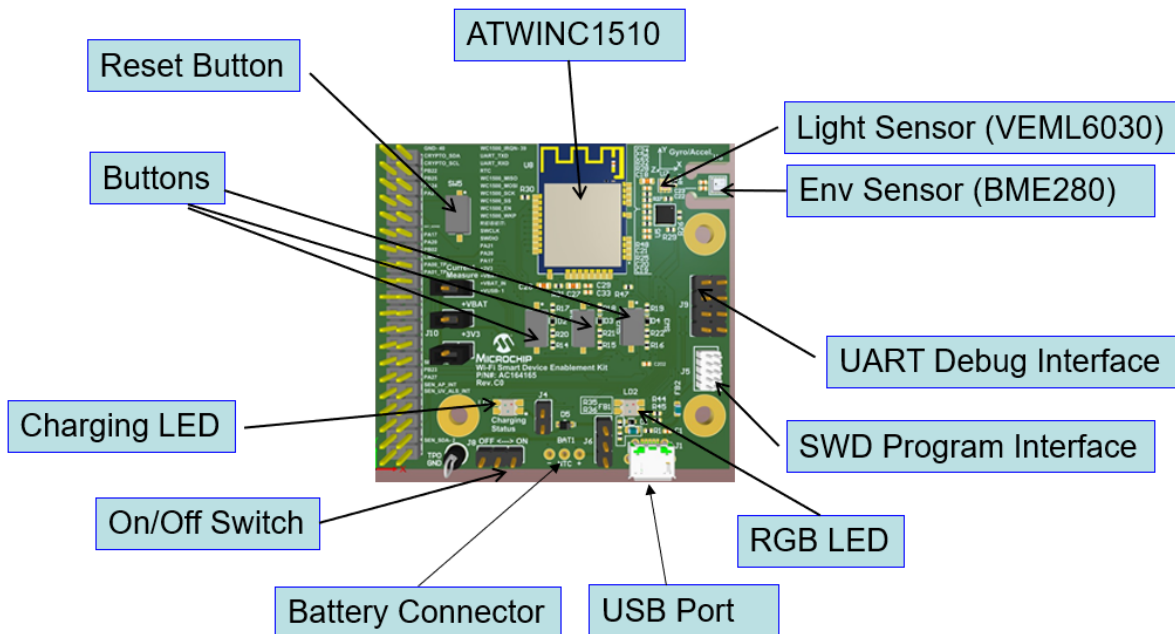
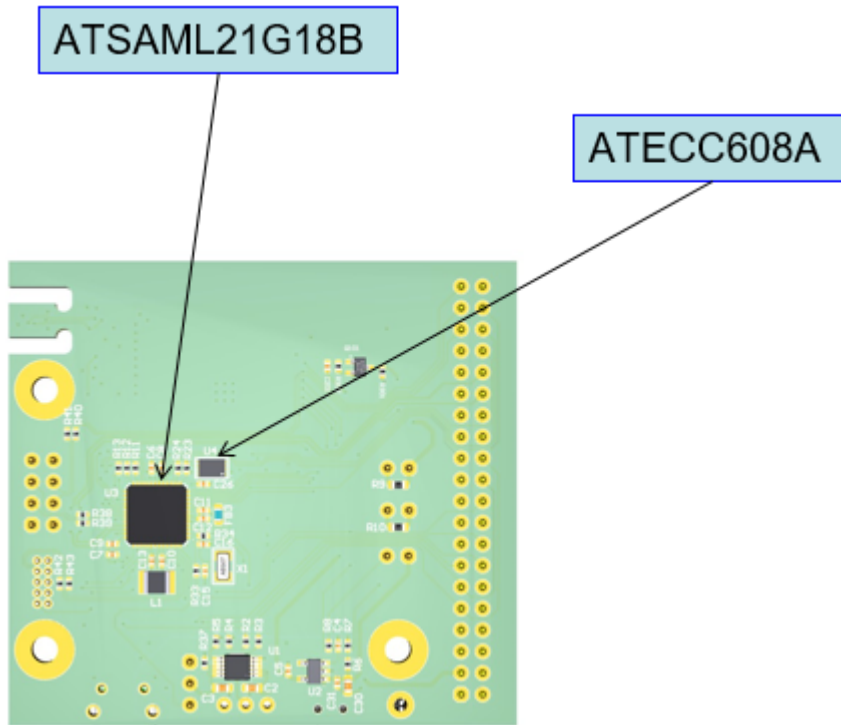

Figure 1-3. Bottom Side



### 1.1.4 Power Supply

The board can be powered-up by USB power or a **TR14500** lithium (3.7V) battery. The jumper **J6** is used to select the power source.

For **USB power** – Short the jumper (shown in red) as shown in the following image.

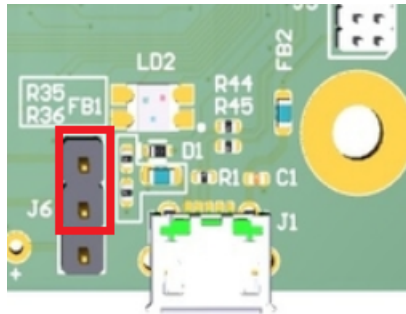

For **Lithium battery** – Short the jumper (shown in blue) as shown in the following image.



### 1.1.4.1 Battery Holder

The AAx1 battery holder, shown in the following image, is required to hold the battery. This holder can be found on the website.

**Figure 1-4. Battery Holder**



A 3 pin wire cable male connector with pitch 2.54 mm is required for the battery holder to connect to the Wi-Fi Smart Device Enablement Kit.

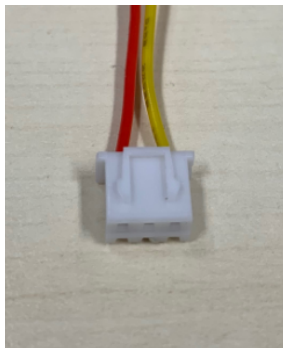

Build the battery holder with connector, as shown in the following image.

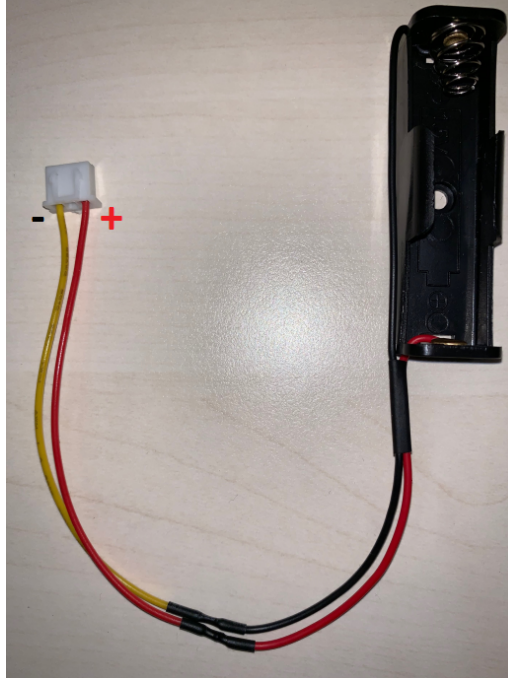

### 1.1.4.2 Battery Charging

A lithium battery can be charged up using USB power. Perform the following steps to charge the battery:

1. Short the Jumper J6, as shown in the following image:



2. Short the Jumper J4.
3. Connect the lithium battery to connector BAT1.
4. Plug in USB power to micro-USB port (J1).  
LD1 color indicates the battery charging status, when LD1 is yellow, remove the USB power. The indication is shown in the following table.

**Table 1-1. LD1 Indication**

LD1 color	Charging Status
Red	Standby
Magenta	Charging is in-progress
Yellow	Charging is complete





Overcharging is not recommended as the package does not include the rechargeable battery and the board does not undergo the overcharging test.

### 1.1.5 Schematic

The schematic of the board can be downloaded from [GitHub](#).

## 1.2 Application

The Wi-Fi Smart Device Enablement Kit is pre-programmed and configured for demonstrating connectivity to the AWS IoT cloud, working with Amazon Alexa. Users can speak to an Echo Dot or use a mobile application in the public network to get the sensor board sensor data and control the LED color. The following diagram is the overview of the application:

**Figure 1-5. Application Overview**



### 1.2.1 Features

- Wi-Fi 802.11 b/g/n Connectivity
- Amazon Web Service (AWS) IoT Cloud Connection
- Sensor Data Update to AWS IoT Shadow
- Compatible with Amazon Alexa
- Mobile Application for Board Registration and Control
- TLS1.2 Mutual Authentication Based on ECDSA with ECC608 Crypto Device
- Powered by Rechargeable 2000 mAh Lithium Battery or USB Interface
- Program/Debug by SWD Interface
- Supports Bootloader

### 1.2.2 Board Operation

The board operates in the following sequence:

1. When power is on, the Wi-Fi Smart Device Enablement Kit goes through the initialization phase where the MCU's internal system, ATWINC15x0, and all connected sensors are initialized.

2. The board attempts to connect to the configured AP. LD2 blinks in blue for every 500 ms during this process.
3. When the board successfully connects to AP and gets the IP address, the LED blinks in blue for every 100 ms. The board attempts to connect to the AWS Cloud after successfully connecting to AP.
4. On successful connection with the cloud, LD2 glows continuously instead of blinking.
5. The board reads the sensor value and LED data, and updates to the cloud with a publish message to AWS IoT shadow for every two seconds.
6. The user can use a mobile application or speak to an Alexa-enabled device (for example, an Echo Dot) to check the sensor values and LED color. The user can also turn on/off the LED and change the LED color by speaking to the Alexa-enabled device or controlling the mobile application. These details are depicted in the following functional flow.

**Figure 1-6. Functional Flow**

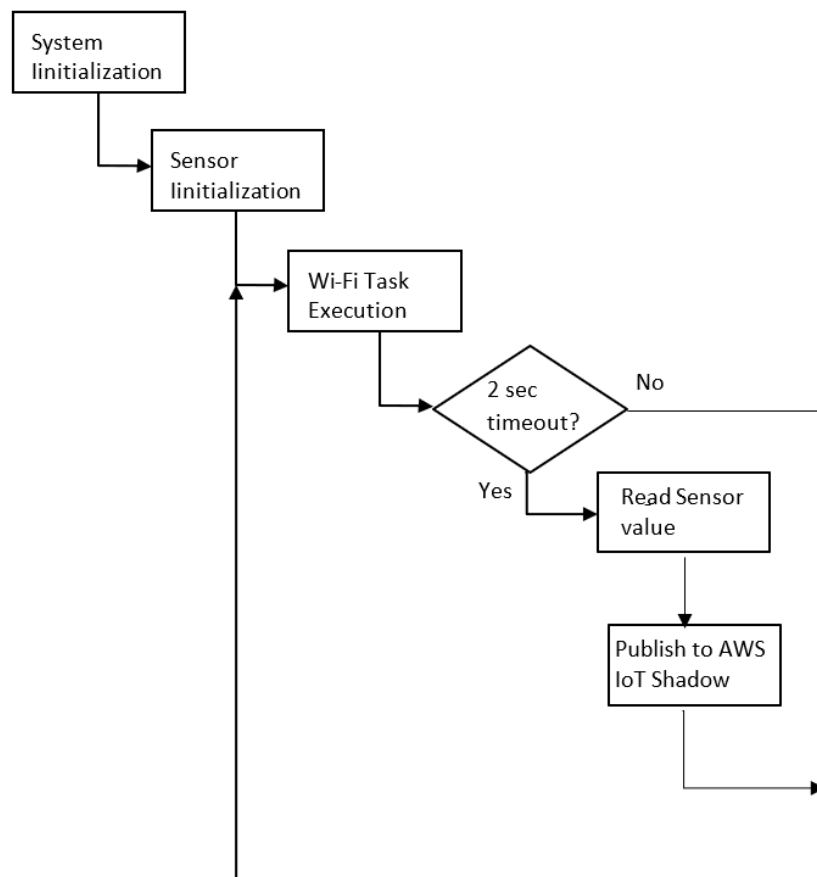

### 1.2.3 LED Indicators

The LD2 LED shows the operation of the board. When the board connects to the AWS cloud, LD2 turns on and the color can be changed using the mobile application or Alexa-enabled devices (for example, an Echo Dot). The following table shows the LD2 indication before successfully connecting to the AWS Cloud.

**Table 1-2. LD2 Indication Before Connecting to the AWS Cloud**

LD2 color	Status	Descriptions
Red	Blinks for every 0.5s	The kit is in the Network Provisioning mode (AP mode).
	Blinks for every 100 ms	The kit is in the Network Provisioning mode (AP mode). Mobile application successfully connects to the kit for network configuration.
Blue	Blinks for every 0.5s	Attempts to connect to the AP.
	Blinks for every 100 ms	Successfully connects to AP, attempts to connect to the AWS IoT Cloud.
	Turn On	Wi-Fi sensor board successfully connects to the AWS IoT Cloud.
Green	Blinks for every 0.5s	The kit is in the ATWINC15x0 Firmware upgrade mode.

The LD1 LED shows the charging status of the lithium battery. The LD1 LED is idle if the battery is not charging. The user can disable this LED by opening the jumper J4, or can enable this LED by shorting the jumper J4 when charging the battery.

**Table 1-3. LD1 Indication**

LD1 Color	Charging Status
Red	Standby
Magenta	Charging is in-progress
Yellow	Charging is complete

### 1.2.4 Buttons

The board has three buttons. The following table lists the functionality of the buttons:

**Table 1-4. Functions of Buttons**

Button	Action	Functions
SW1	Press and hold for 3 sec once system is powered on	Enters the Bootloader mode LD2 LED turns off when the Bootloader mode is triggered
SW2	Press and hold for 3 sec once system is powered on	Enters the ATWINC15x0 Firmware Upgrade mode
SW3	Press and hold for 5 sec once system is powered on	Enters the Network Provisioning mode
SW1, SW2, SW3	Short press	Toggles the button state. The button state can be monitored on the mobile application or by Alexa.

### 1.2.5 AWS Provision with ECC608

The board is provisioned to the AWS IoT of Microchip account out-of-box. Unique device certificate and private key are generated and stored to ECC608 in each of the secure Wi-Fi boards during the factory manufacturing process. The CA certificate used to sign the device certificates is also registered to the

AWS IoT. When the board is configured to connect to an Access Point, it can connect to the AWS IoT endpoint. A Lambda function running on AWS Cloud registers the board to the AWS IoT when the board connects to the AWS IoT endpoint the first time.

### 1.2.6 MCU Firmware

The MCU firmware source code can be download from GitHub [here](#). Developers can follow the developer guide to customize the application.

### 1.2.7 Mobile Application

The mobile application is available for users to register and control the board. The source code is published on GitHub for reference.

- [Android™ app](#)
- [Android source code](#)
- [iOS app](#)
- [iOS app source code](#)

**Figure 1-7. Application Logo**



## 2. Getting Started

### 2.1 Set Up the Board with Android App

This section details how to create the account, register and control the board using the mobile application.

#### 2.1.1 Create a User Account

To use the board, the user must create a user account. Perform the following steps to create and sign up for a user account using the mobile application.

1. Launch the mobile application. Click **Sign up** (below the Sign in button).

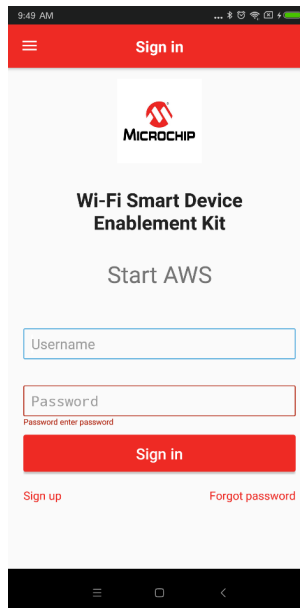

2. Enter the **Username**, **Password**, and **Email** and click **Sign up** button.

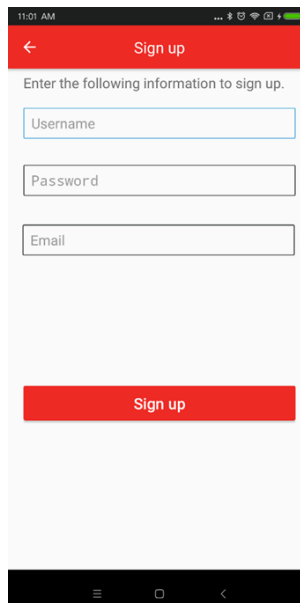

3. A confirmation code is sent to the email. Check the email and enter the confirmation code as shown in the following screenshot.

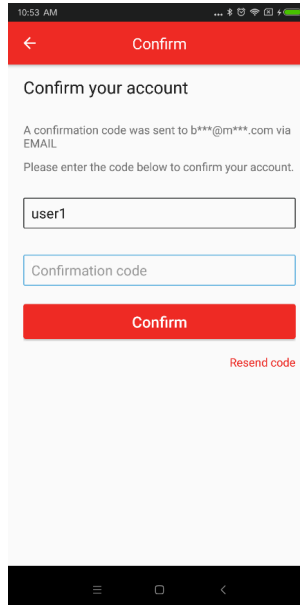

If the confirmation code is correct, a success message is shown and the user account is successfully created. The user can use this account to log in to the mobile application and enable Alexa Skill in the Alexa app when the Alexa feature is set up.

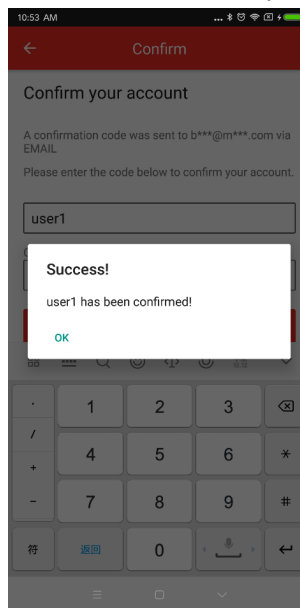

### 2.1.2 Register the Board

To control the board, the user must register the board to their user account. The registration process is used to configure the board to connect to a network and register the board to the user account.

During this process, the user account ID and board ID are stored in a database in AWS Cloud. After logging in to the mobile application, the mobile application searches for the board ID based on the user account ID in the database and shows the corresponding device on the application.

1. Launch mobile application.

2. Log in to the application using user account.

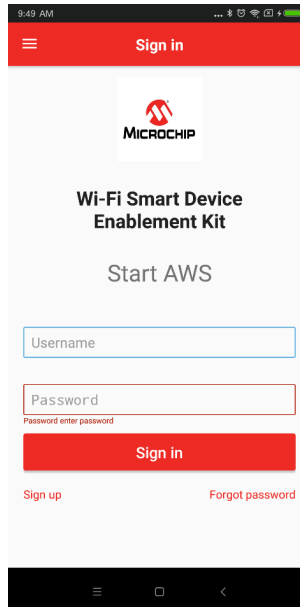

3. The application shows the registered devices. Initially, the list is empty.

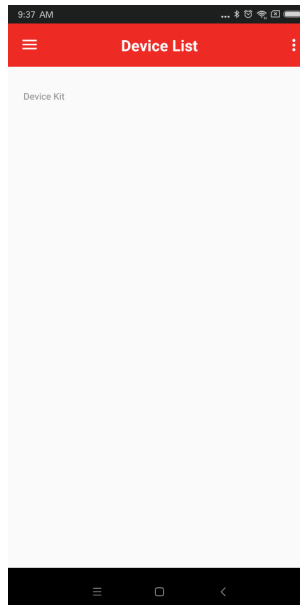

4. Tap **Add devices** option. Instructions to provision the network are shown in the application.

# ATWINC15x0 Smart Device Kit

## Getting Started

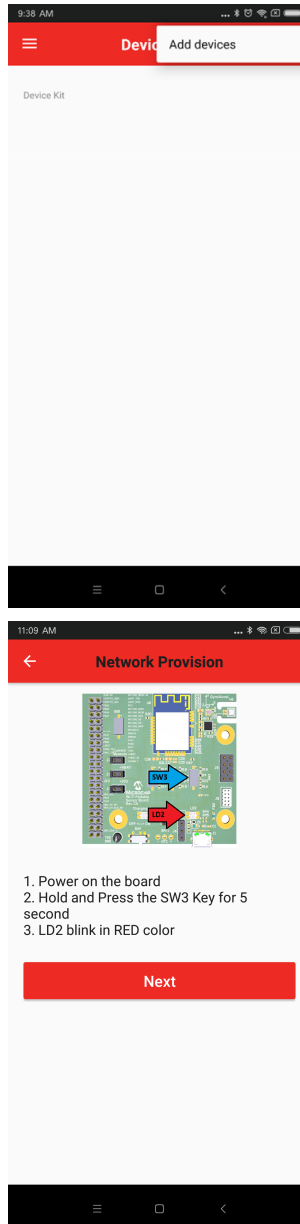

5. Follow the instructions, and plug in USB power to the USB port or use a lithium battery to provide power. For power supply settings, see [1.1.4 Power Supply](#).
6. Connect J8 jumper (pin 2 and pin 3) to switch on the board as shown in the following image.





# ATWINC15x0 Smart Device Kit

## Getting Started

7. Hold and press the SW3 key for 5 seconds. LD2 blinks red, as the board enters to the Network Provisioning mode. LD2 blinks red for every 0.5 sec.
8. Tap **Next** on the mobile application. The following screen is displayed.

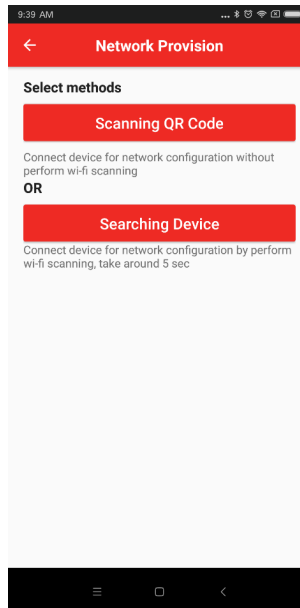

There are two methods to connect the board for registration.

Method 1 – scans the QR code on the label of the ATWINC1510 module.

Method 2 – searches the board by performing Wi-Fi scan. This method takes five to ten seconds to perform Wi-Fi scan.

9. Tap **Scanning QR Code** to scan the QR code printed on the label of the ATWINC1510 module or tap **Searching Device** to go to next step.

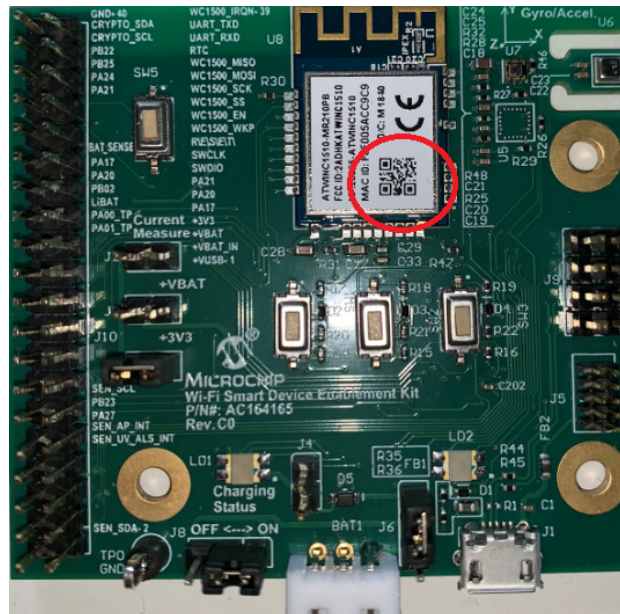

10. Select the network to which the board needs to connect.

# ATWINC15x0 Smart Device Kit

## Getting Started

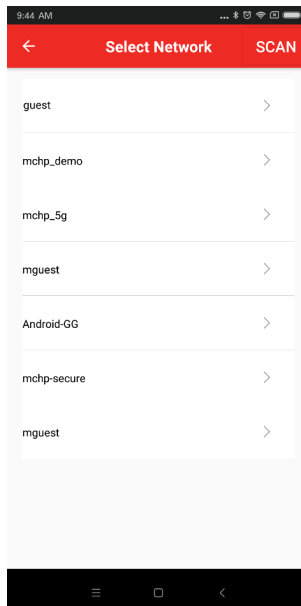

11. Enter the password of the network, and tap **OK**.

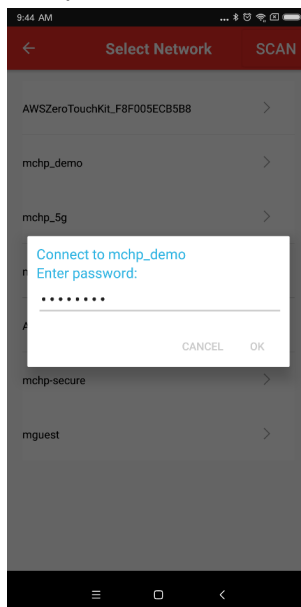

12. Enter the Device Name, and tap **Set**. A loading screen is shown to display the provisioning is in progress.

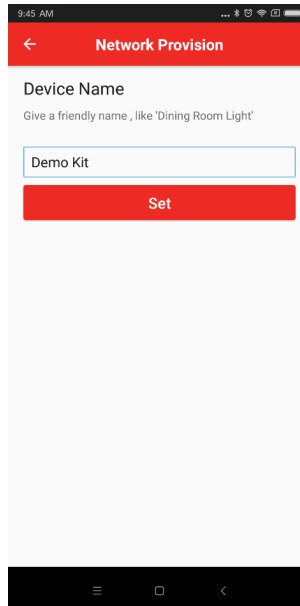

13. On successful provisioning, the application lists the device list.

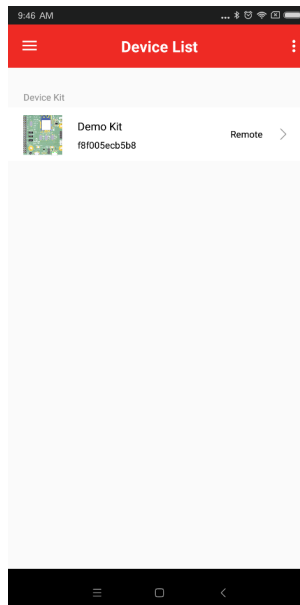

### 2.1.3 Control the Board

The user can use the mobile application to monitor or control the Wi-Fi Smart Device Enablement Kit. After the user registers the board using the mobile application, they can select the board on the application. The following screen is shown to monitor or control the board:

Figure 2-1. Demo Kit Screen

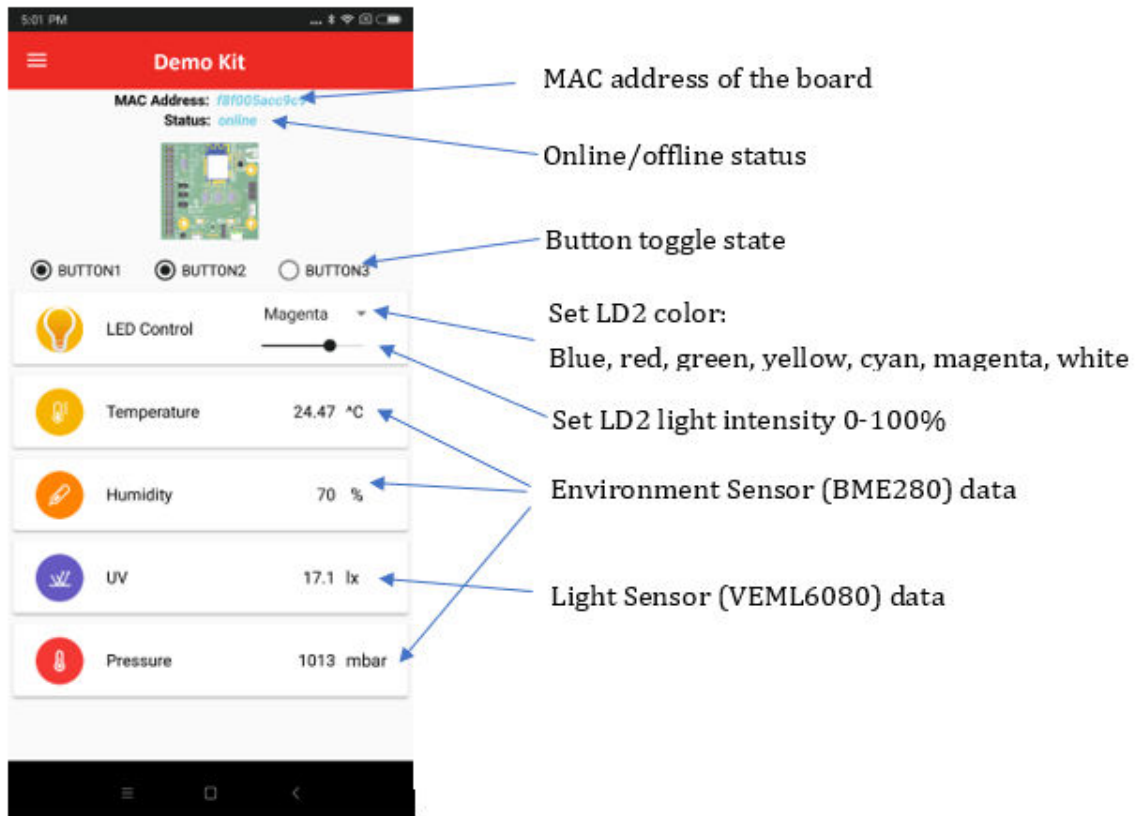

## 2.2 Set Up the Board with iOS App

This section details how to create the account, register and control the board using the mobile application.

### 2.2.1 Create a User Account

To use the board, the user must create a user account. Perform the following steps to create and sign up for a user account using the iOS mobile application.

1. Launch the mobile application. Click **Sign up** (below the Sign in button).

# ATWINC15x0 Smart Device Kit

## Getting Started

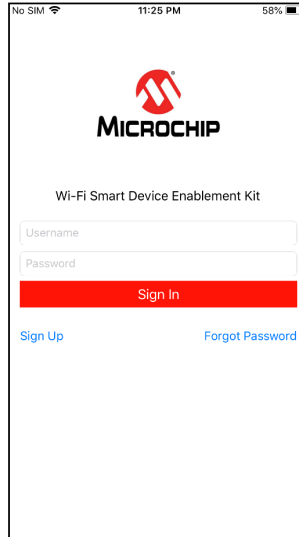

2. Enter the **Username**, **Password**, and **Email** and click **Sign up** button.

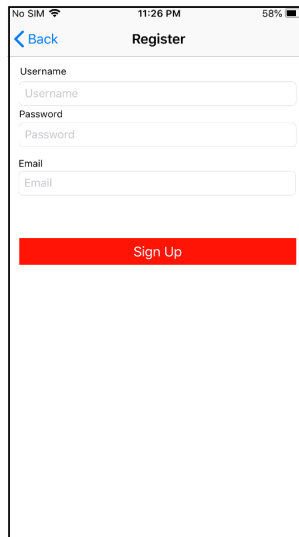

3. A confirmation code is sent to the email. Check the email and enter the confirmation code as shown in the following screenshot.

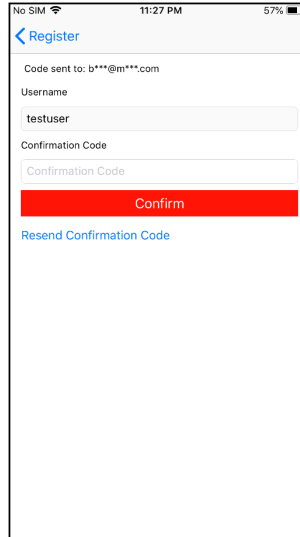

If the confirmation code is correct, a success message is shown and the user account is successfully created. The user can use this account to log in to the mobile application and enable Alexa Skill in the Alexa app when the Alexa feature is set up.

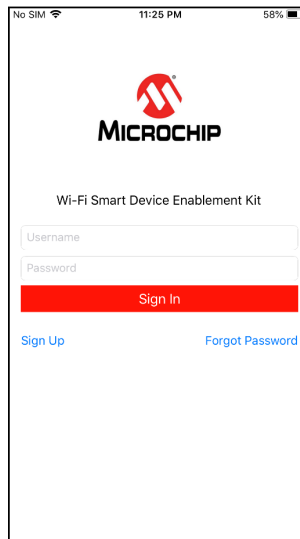

### 2.2.2 Register the Board

To control the board, the user must register the board to their user account. The registration process is used to configure the board to connect to a network and register the board to the user account.

During this process, the user account ID and board ID are stored in a database in the AWS Cloud. After logging in to the mobile application, the mobile application searches for the board ID based on the user account ID in the database and shows the corresponding device on the application.

1. Launch mobile application.
2. Log in to the application using user account.

# ATWINC15x0 Smart Device Kit

## Getting Started

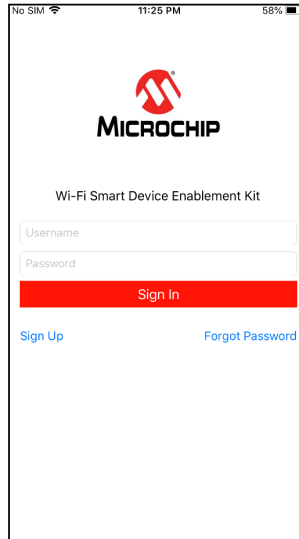

3. The application shows the registered devices. Initially, the list is empty.



4. Tap **Add devices** option. Instructions to provision the network are shown in the application.

# ATWINC15x0 Smart Device Kit

## Getting Started

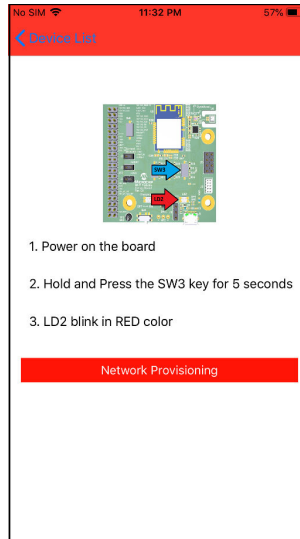

5. Follow the instructions, and plug in USB power to the USB port or use a lithium battery to provide power. For power supply settings, see [1.1.4 Power Supply](#).
6. Connect J8 jumper (pin 2 and pin 3) to switch on the board as shown in the following image.

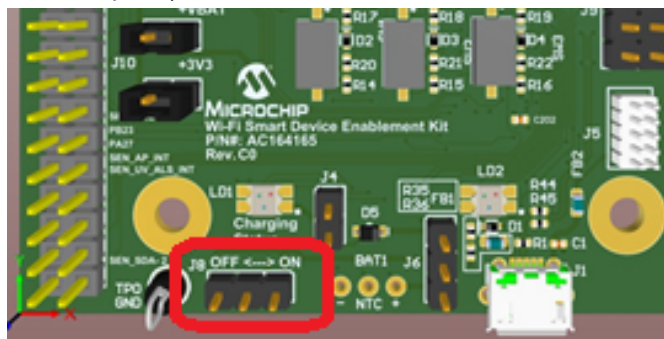

7. Hold and press SW3 key for 5 seconds. LD2 blinks red as the board enters to the Network Provisioning mode. LD2 blinks red for every 0.5 sec.
8. Tap **Network Provisioning** on the mobile application. The following screen is displayed.

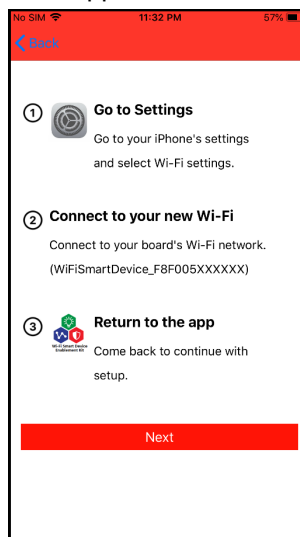

9. Following the instruction in the UI, go to iOS device setting page and select **Wi-Fi Setting**.



# ATWINC15x0 Smart Device Kit

## Getting Started

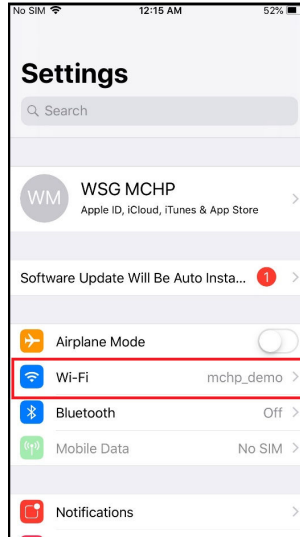

10. Select the board Wi-Fi Network (WiFiSmartDevice\_F8F005XXXXXX).

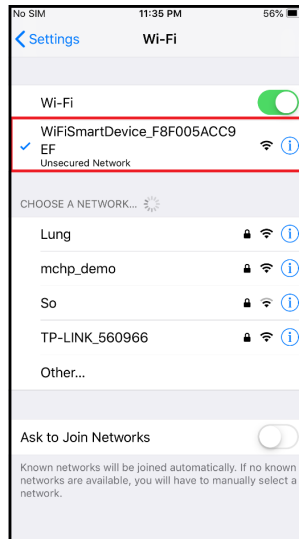

11. Go back to the app and click the **Next** button.
12. Enter the Network SSID and password. (Only networks with WPA or WPA2 can be supported).

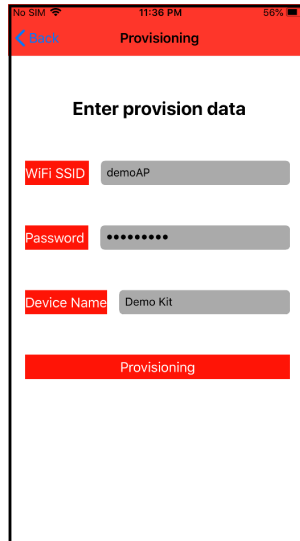

13. Enter the Device Name, and tap **Set**. A loading screen is shown to display the provisioning is in progress.

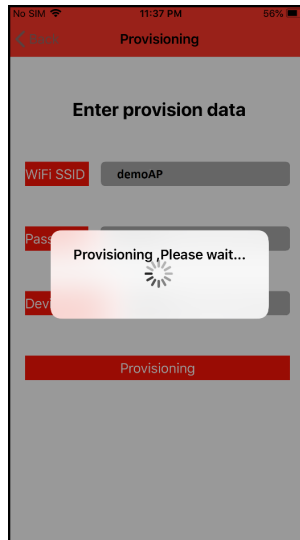

14. Upon successful provisioning, the application shows the device list.



### 2.2.3 Control the Board

The user can use the mobile application to monitor or control the Wi-Fi Smart Device Enablement Kit. After the user uses the mobile application to register the board, they can select the board on the application GUI. The following screen is shown to monitor or control the board:

**Figure 2-2. Demo Kit Screen**

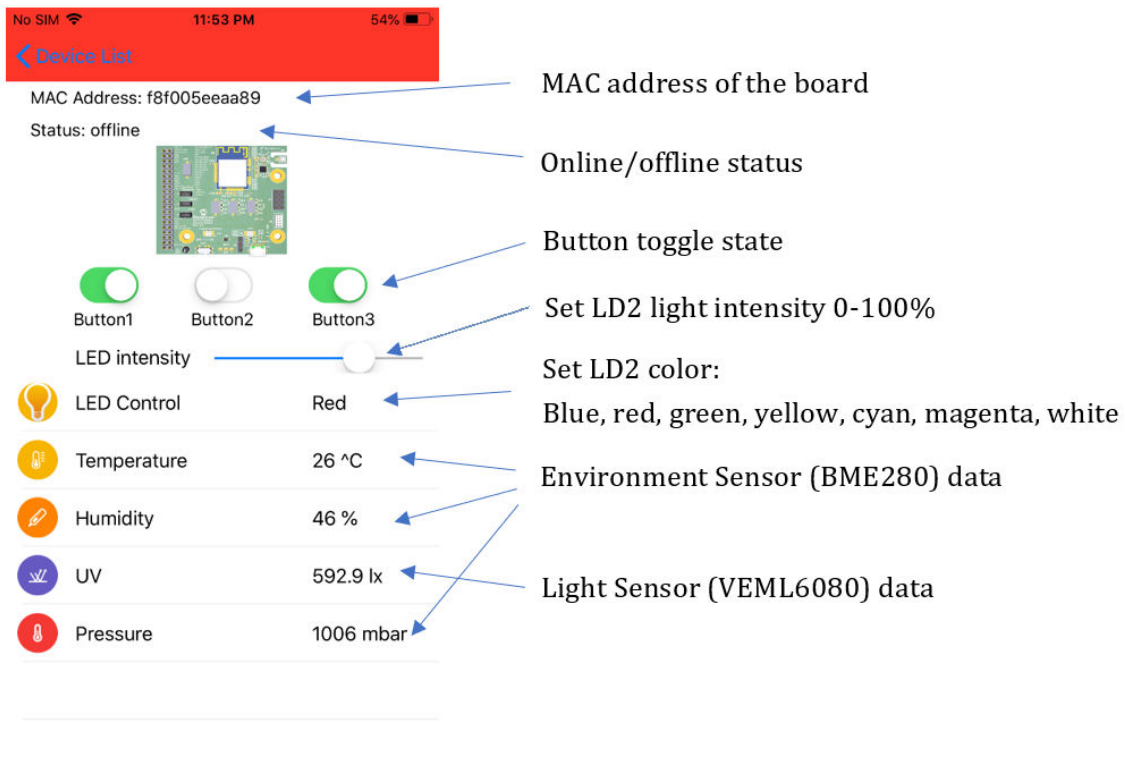

### 2.3 Enable Amazon Alexa on the Board

Amazon Alexa is a voice assistant developed by Amazon. With Amazon Alexa, the board can function with a set of voice commands. Alexa Skill is a set of capabilities. Amazon allows developers to build the skills and publish skills for Alexa.

There are two Alexa Skills for the Wi-Fi Smart Device Enablement Kit, as follows:

- Microchip Sensor Board Skill
- Microchip Wi-Fi Smart Device Smart Home Skill

#### Microchip Sensor Board Skill

This skill is an Alexa Custom Skill, which can be customized by developers. More features can be supported on this skill. However, Alexa mobile application cannot control the board; only the Wi-Fi Smart Device Enablement Kit Mobile application can be used to control and read the sensor value from the board.

**Figure 2-3. Microchip Sensor Board Skill**

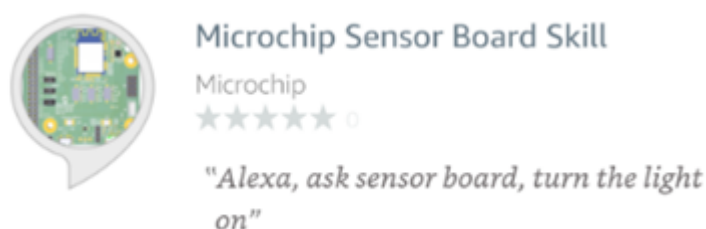

The following table provides detailed information to use Microchip Sensor Board Skill.

**Table 2-1. Function List**

Function	Voice Command
Turn On/ Off LED LD2	Turn the light on/off
Turn LED LD2 to different color	Turn the light blue/green/red/yellow/white/cyan/magneta
Get LED LD2 color	What is the light color?
Get LED LD2 On/Off state	What is the light state?
Get button (SW1, SW2, SW3) status	What are the button states?
Get temperature/humidity from the Kit	What is the temperature/humidity?
Assert the Port A 17/20 or 21 GPIO to high/ low	Set/Clear Port A 17/20/ 21
Assert the Port B 22/23 to high/ low	Set/Clear Port B 22/ 23

**Note:**

1. **Sensor Board** is the invocation to trigger the skill.
2. This skill is not supported if more than one device is registered to the mobile application account.

#### Microchip Wi-Fi Smart Device Smart Home Skill

This skill is an Alexa Smart Home Skill, which is predefined by Amazon. The user can use the Alexa mobile application to enable this skill and perform the device discovery process to discover the board. In

In addition to the voice control, the user can also control the board LED LD2 either on the Alexa mobile application or on the Wi-Fi Smart Device Enablement Kit Mobile application (see 2.1.3 [Control the Board](#)).

**Figure 2-4. Microchip Wi-Fi Smart Device Smart Home Skill**



**Table 2-2. Function List**

Function	Voice Command
Turn On/Off LED LD2	Turn on/off <DEVICE_NAME>
Adjust light intensity of LED LD2	Set the power to [0 - 100]% on <DEVICE_NAME>

### 2.3.1 Set up Alexa on Amazon Echo Dot

Perform the following steps to set up Alexa on Amazon Echo Dot.

1. Install the Alexa mobile application ([Android devices](#) or [iOS devices](#)).
2. Create an Alexa account and sign in to the Alexa mobile application.
3. Refer to the link below to set up Echo Dot:  
<https://www.amazon.com/gp/help/customer/display.html?nodeId=201994280>

### 2.3.2 Enable Microchip Wi-Fi Smart Device Smart Home Skill

Perform the following steps to enable Microchip Wi-Fi Smart Device Smart Home Skill.

1. Launch Alexa mobile application, and tap "≡" in the upper left hand corner.
2. Select **Skills**.

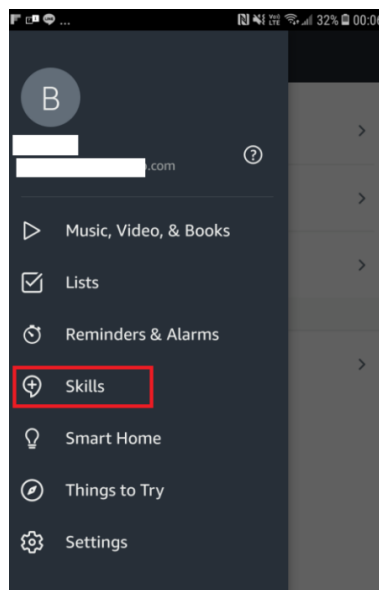

3. Type "Microchip wi-fi smart device" in the search bar, and tap **Microchip Wi-Fi Smart Device Smart Home Skill**.

# ATWINC15x0 Smart Device Kit

## Getting Started

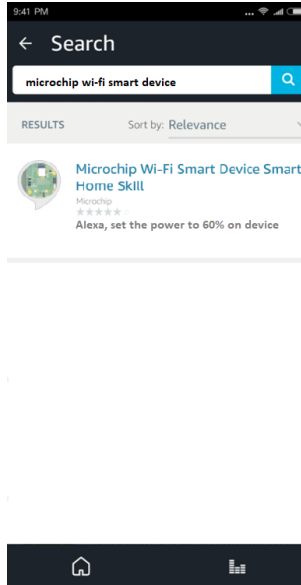

4. Tap **ENABLE TO USE**.

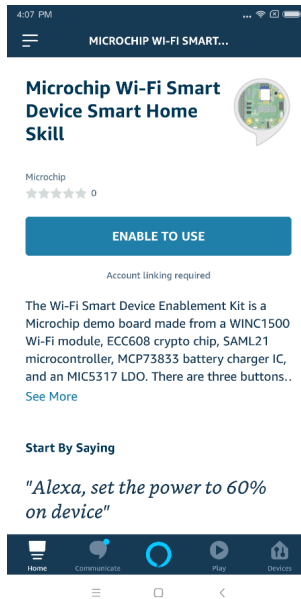

5. Enter the **Username** and **Password** created in [2.1.1 Create a User Account](#)/[2.2.1 Create a User Account](#) and tap **Sign in**.

# ATWINC15x0 Smart Device Kit

## Getting Started

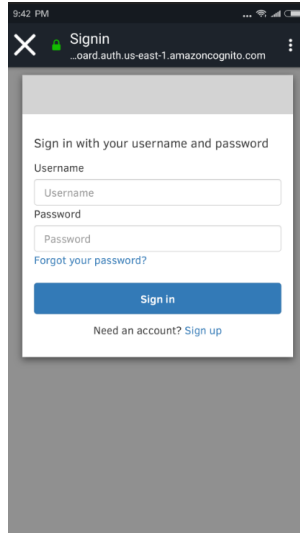

The application will show that the Microchip Sensor Skill is successfully linked.

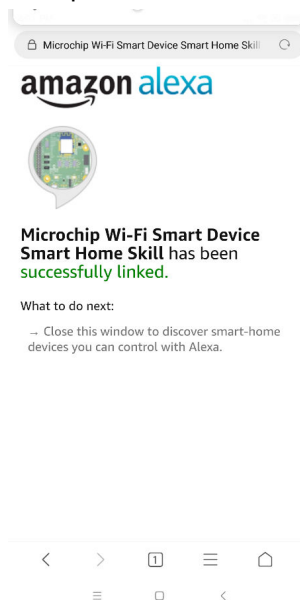

6. Close this window to continue.
7. Tap **Discover Devices** in to discover the devices.

# ATWINC15x0 Smart Device Kit

## Getting Started

4:11 PM

### Discover Devices

Smart Home devices must be discovered before they can be used with Alexa.



The application shows that Alexa is discovering devices.

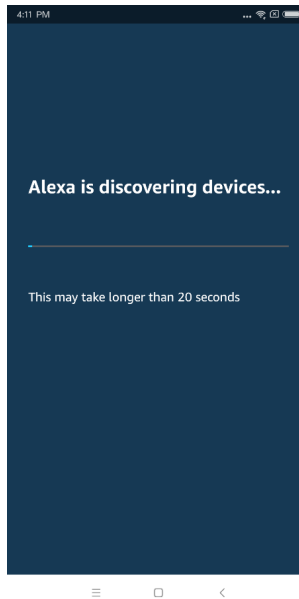

8. When one light device is found, the following screen appears.



# ATWINC15x0 Smart Device Kit

## Getting Started

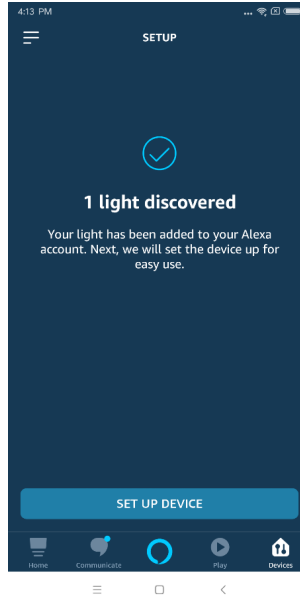

9. Tap **SET UP DEVICE** option.

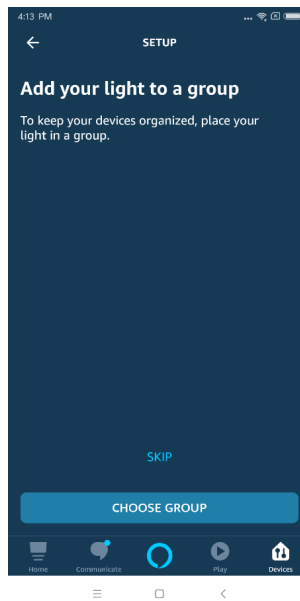

10. Tap **SKIP** to skip adding the device to a group.  
Demo Kit is set up successfully.

# ATWINC15x0 Smart Device Kit

## Getting Started

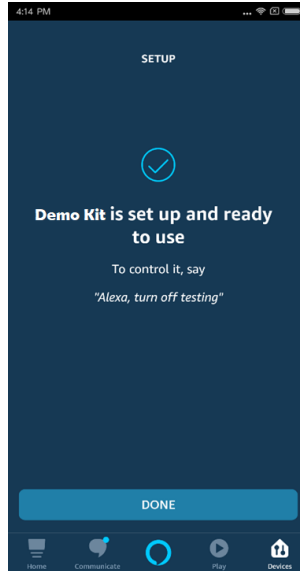

11. Select the **Devices** icon, and tap **Lights**.

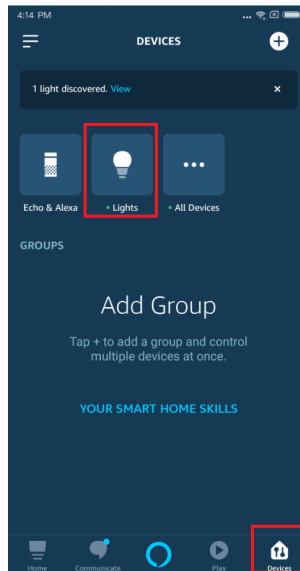

A Device can be found in this page (in this case, the device name is "Demo Kit").

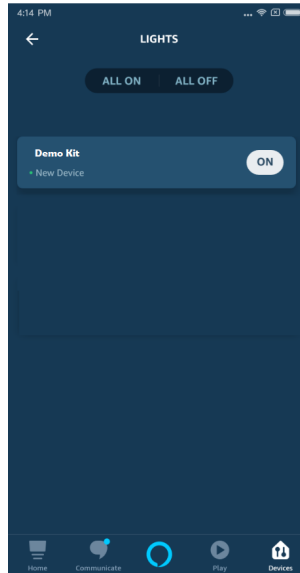

12. Tap the device icon.

User can turn on/off and control the light intensity of the LED LD2 on this page of the Alexa mobile application.

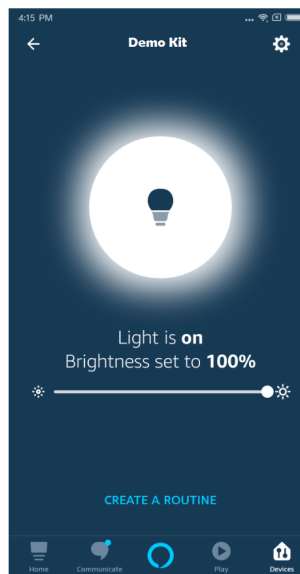

### 2.3.3 Enable Microchip Sensor Board Skill

Perform the following steps to enable Microchip Sensor Board Skill.

1. Launch Alexa mobile application, and tap "☰" in the upper left hand corner.
2. Select **Skills**.

# ATWINC15x0 Smart Device Kit

## Getting Started

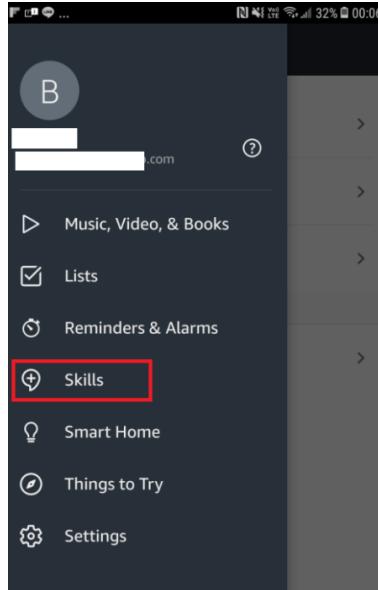

3. Type “sensor” in the search bar, then tap **Microchip Sensor Skill**.

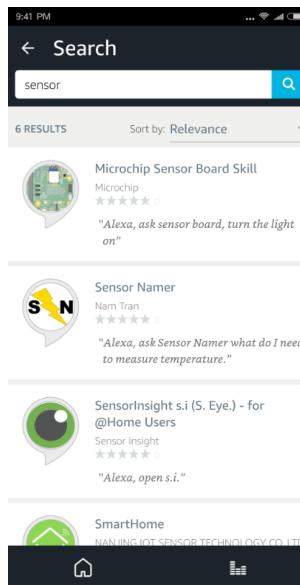

4. Tap **ENABLE**.

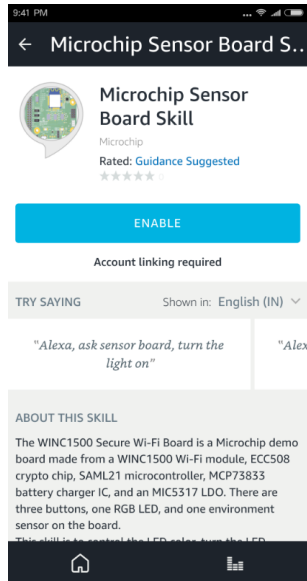

5. Enter the **Username** and **Password** created in [2.1.1 Create a User Account](#)/[2.2.1 Create a User Account](#) and tap **Sign in**.  
The application will show that the Microchip Sensor Board Skill is successfully linked.

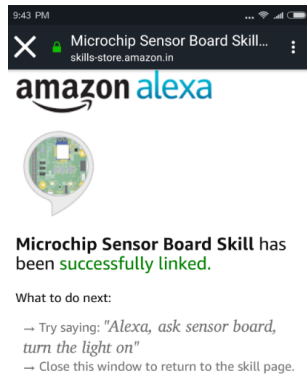

## 2.3.4 Control and Monitor the Wi-Fi Smart Device Enablement Kit Using Voice Commands with Echo Dot

### 2.3.4.1 Voice Control of Microchip Wi-Fi Smart Device Smart Home Skill

For the detailed function list of the voice command, see [2.3 Enable Amazon Alexa on the Board](#).

**Note:** User needs to say “Alexa” to prefix opening the conversation. Invocation is not needed to trigger the skill.

#### 2.3.4.1.1 Example Voice Command

In the following example, the board name is “**demo kit**”. The board name can be changed using the mobile application during the board registration procedure.

### **Usage – Turn on/off the LED LD2**

*User* – Alexa, turn on demo kit.

*Echo Dot* – Ok

### **Usage – Set the light intensity of LED LD2**

*User* – Alexa, set the power to 60% on demo kit.

*Echo Dot* – Ok

#### **2.3.4.2 Voice Control of Microchip Sensor Board Skill**

For the detailed function list of the voice command, see [2.3 Enable Amazon Alexa on the Board](#).

**Note:** User needs to say “Alexa” to prefix opening the sensor board. This opens a session and the user does not need to prefix the command with “Alexa” after opening the session.

**Sensor Board** is the invocation to trigger the skill.

##### **2.3.4.2.1 Example Conversation**

*User* – Alexa, open sensor board

*Echo Dot* – Welcome to Microchip Sensor Board Skill. This skill is used to control and get the sensor data from Wi-Fi Smart Device Enablement Kit

*User* – What is the temperature?

*Echo Dot* – The temperature is 93.70 degrees Fahrenheit, please provide other command.

*User* – What is the button status?

*Echo Dot* – The button states are, button1 is up, button2 is up, button3 is up, please provide other command.

*User* – Turn the light Blue

*Echo Dot* – The sensor board light is blue (LD2 on the board turn to blue color), please provide other command.

*User* – Set demo kit Port A 17

*Echo Dot* – PORT A 17 will be set, please provide other command (PortA 17 on the board is set to high)

*User* – Clear demo kit Port A 17

*Echo Dot* – PORT A 17 will be clear, please provide other command (PortA 17 on the board is set to low)

*User* – Stop

*Echo Dot* – Thank you for using the Microchip Sensor Board Demo. Have a nice day!

### 3. Board Development

Developers can customize the board features by modifying the firmware. The board is pre-programmed with a bootloader. A developer can use Atmel Studio to compile the firmware and program the firmware to the board with SAM-BA in-system programmer through USB interface.

If developers need to use a debugger for development, Atmel-ICE is required. Firmware is programmed to the board through SWD interface by Atmel-ICE.

**Note:** The pre-programmed AWS account credentials will be lost once the user re-programs the board.

The user needs to migrate the board to connect the private AWS account when performing the customization.

For more details on the programming procedure, firmware customization and cloud setup, refer the Developer's Guide.

## 4. Board Debugging

### 4.1 UART Debug Interface

The Wi-Fi Smart Device Enablement Kit has debug UART pins. The pins are connected to the J9 connector. The user can utilize a USB-to-UART converter to connect the computer, and the board Debug UART to capture the MCU log.

**Figure 4-1. UART Debug Interface**

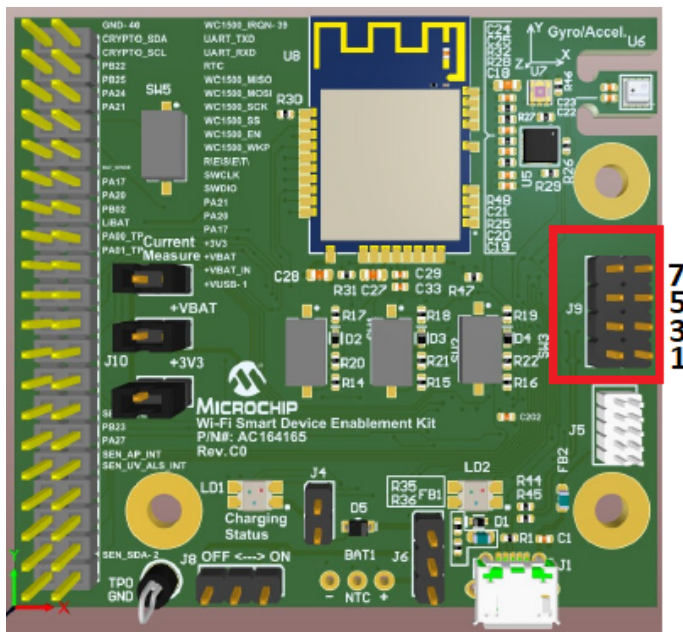

**Table 4-1. UART Debug Interface Pin Details**

Pin	Function
3	DEBUG_UART_RXD
5	DEBUG_UART_TXD
7	GND

### 4.2 Install a Terminal Emulator

A terminal emulator helps the user to diagnose problems or verify the device code is running. There are variety of terminal emulators available for Windows®, macOS®, and Linux®. The user must connect the device to a computer before connecting to a terminal emulator of the device.

Use the following settings in the terminal emulator:

**Table 4-2. Terminal Setting**

Terminal Setting	Value
Port	Depends on platform and other devices the user has connected to computer



.....continued

Terminal Setting	Value
BAUD rate	115200
Data	8 bit
Parity	none
Stop	1 bit
Flow control	none

**Figure 4-2. Application Boot Up Log**

```

COM10 - Tera Term VT
File Edit Setup Control Window Help
Initializing Wi-Fi Smart Device Enablement Kit
cpu_freq=48005120
Firmware version: 1.0.1
status = 0
AWS_STATE_ATECCx08A_INIT
  wifiInit In
    (APP)<INFO>Chip ID 1503a0
    (APP)<INFO>DriverVerInfo: 0x13521352
    (APP)<INFO>Firmware ver : 19.5.2 Sunrev 14274
    (APP)<INFO>Firmware Build Jan 26 2017 Time 22:13:34
    (APP)<INFO>Firmware Min driver ver : 19.3.0
    (APP)<INFO>Driver ver: 19.5.2
    (APP)<INFO>Driver built at Mar 13 2019 22:09:39
MAC Address: F8:F0:05:AC:C9:F7
gAwsMqttClientId Address: f8f005acc9f7
use default SSID
gDefaultSSID=LucNetwork_HiSpeed_24, pw=luc4614193, auth=2, ssidlen=21, pslen=10
. ret = 0
ecc_transfer_certificates, g_thing_name = 775733aafaca37f9bd2dd7e94158b2558e274107
provisioning_get_ssid, ssid = mchp_demo
provisioning_get_password, password = mchp5678
nvds_read start
nvm page_size = 64
nvm no_of_page = 4096
wifi_cb: M2M_WIFI_RESP_COM_STATE_CHANGED: CONNECTED
wifi_cb: M2M_WIFI_REQ_DHCP_CONF: IP is 172.20.10.5
Received time
Connecting...Received time
Host IP is 34.204.236.48
(APP)<INFO>Socket 0 session ID = 1
Successfully connected.
Subscribing...Subscription success
Subscribing...Subscription success
DBG: temperature = 3004, humidity = 47, uv = 27027000, pressure = 1006
  
```

### 5. Design Documents and Related Links

- [ATWINC15x0 Module Datasheet](#)
- [SAML21G18B Host MCU](#)
- [ATECC608A CryptoAuthentication™ Device](#)
- [BME280](#)
- [Demo application firmware and mobile application software](#)
- [Wi-Fi Sensor board schematics](#)

## 6. Document Revision History

Revision	Date	Section	Description
A	05/2019	Document	Initial Revision

**Regulatory Notice:**

The unit is a development/evaluation tool which is designed to be used for research and development in a laboratory environment. The unit is not intended to be a finished appliance, nor is it intended for incorporation into finished appliances that are made commercially available as single functional units to end users.

## The Microchip Web Site

---

Microchip provides online support via our web site at <http://www.microchip.com/>. This web site is used as a means to make files and information easily available to customers. Accessible by using your favorite Internet browser, the web site contains the following information:

- **Product Support** – Data sheets and errata, application notes and sample programs, design resources, user's guides and hardware support documents, latest software releases and archived software
- **General Technical Support** – Frequently Asked Questions (FAQ), technical support requests, online discussion groups, Microchip consultant program member listing
- **Business of Microchip** – Product selector and ordering guides, latest Microchip press releases, listing of seminars and events, listings of Microchip sales offices, distributors and factory representatives

## Customer Change Notification Service

---

Microchip's customer notification service helps keep customers current on Microchip products. Subscribers will receive e-mail notification whenever there are changes, updates, revisions or errata related to a specified product family or development tool of interest.

To register, access the Microchip web site at <http://www.microchip.com/>. Under "Support", click on "Customer Change Notification" and follow the registration instructions.

## Customer Support

---

Users of Microchip products can receive assistance through several channels:

- Distributor or Representative
- Local Sales Office
- Field Application Engineer (FAE)
- Technical Support

Customers should contact their distributor, representative or Field Application Engineer (FAE) for support. Local sales offices are also available to help customers. A listing of sales offices and locations is included in the back of this document.

Technical support is available through the web site at: <http://www.microchip.com/support>

## Microchip Devices Code Protection Feature

---

Note the following details of the code protection feature on Microchip devices:

- Microchip products meet the specification contained in their particular Microchip Data Sheet.
- Microchip believes that its family of products is one of the most secure families of its kind on the market today, when used in the intended manner and under normal conditions.
- There are dishonest and possibly illegal methods used to breach the code protection feature. All of these methods, to our knowledge, require using the Microchip products in a manner outside the operating specifications contained in Microchip's Data Sheets. Most likely, the person doing so is engaged in theft of intellectual property.
- Microchip is willing to work with the customer who is concerned about the integrity of their code.

- Neither Microchip nor any other semiconductor manufacturer can guarantee the security of their code. Code protection does not mean that we are guaranteeing the product as “unbreakable.”

Code protection is constantly evolving. We at Microchip are committed to continuously improving the code protection features of our products. Attempts to break Microchip’s code protection feature may be a violation of the Digital Millennium Copyright Act. If such acts allow unauthorized access to your software or other copyrighted work, you may have a right to sue for relief under that Act.

## Legal Notice

---

Information contained in this publication regarding device applications and the like is provided only for your convenience and may be superseded by updates. It is your responsibility to ensure that your application meets with your specifications. MICROCHIP MAKES NO REPRESENTATIONS OR WARRANTIES OF ANY KIND WHETHER EXPRESS OR IMPLIED, WRITTEN OR ORAL, STATUTORY OR OTHERWISE, RELATED TO THE INFORMATION, INCLUDING BUT NOT LIMITED TO ITS CONDITION, QUALITY, PERFORMANCE, MERCHANTABILITY OR FITNESS FOR PURPOSE. Microchip disclaims all liability arising from this information and its use. Use of Microchip devices in life support and/or safety applications is entirely at the buyer’s risk, and the buyer agrees to defend, indemnify and hold harmless Microchip from any and all damages, claims, suits, or expenses resulting from such use. No licenses are conveyed, implicitly or otherwise, under any Microchip intellectual property rights unless otherwise stated.

## Trademarks

---

The Microchip name and logo, the Microchip logo, AnyRate, AVR, AVR logo, AVR Freaks, BitCloud, chipKIT, chipKIT logo, CryptoMemory, CryptoRF, dsPIC, FlashFlex, flexPWR, Heldo, JukeBlox, KeeLoq, Kleer, LANCheck, LINK MD, maXStylus, maXTouch, MediaLB, megaAVR, MOST, MOST logo, MPLAB, OptoLyzer, PIC, picoPower, PICSTART, PIC32 logo, Prochip Designer, QTouch, SAM-BA, SpyNIC, SST, SST Logo, SuperFlash, tinyAVR, UNI/O, and XMEGA are registered trademarks of Microchip Technology Incorporated in the U.S.A. and other countries.

ClockWorks, The Embedded Control Solutions Company, EtherSynch, Hyper Speed Control, HyperLight Load, IntelliMOS, mTouch, Precision Edge, and Quiet-Wire are registered trademarks of Microchip Technology Incorporated in the U.S.A.

Adjacent Key Suppression, AKS, Analog-for-the-Digital Age, Any Capacitor, AnyIn, AnyOut, BodyCom, CodeGuard, CryptoAuthentication, CryptoAutomotive, CryptoCompanion, CryptoController, dsPICDEM, dsPICDEM.net, Dynamic Average Matching, DAM, ECAN, EtherGREEN, In-Circuit Serial Programming, ICSP, INICnet, Inter-Chip Connectivity, JitterBlocker, KleerNet, KleerNet logo, memBrain, Mindi, MiWi, motorBench, MPASM, MPF, MPLAB Certified logo, MPLIB, MPLINK, MultiTRAK, NetDetach, Omniscient Code Generation, PICDEM, PICDEM.net, PICKit, PICtail, PowerSmart, PureSilicon, QMatrix, REAL ICE, Ripple Blocker, SAM-ICE, Serial Quad I/O, SMART-I.S., SQI, SuperSwitcher, SuperSwitcher II, Total Endurance, TSHARC, USBCheck, VariSense, ViewSpan, WiperLock, Wireless DNA, and ZENA are trademarks of Microchip Technology Incorporated in the U.S.A. and other countries.

SQTP is a service mark of Microchip Technology Incorporated in the U.S.A.

Silicon Storage Technology is a registered trademark of Microchip Technology Inc. in other countries.

GestIC is a registered trademark of Microchip Technology Germany II GmbH & Co. KG, a subsidiary of Microchip Technology Inc., in other countries.

All other trademarks mentioned herein are property of their respective companies.

© 2019, Microchip Technology Incorporated, Printed in the U.S.A., All Rights Reserved.

ISBN: 978-1-5224-4473-2

## Quality Management System Certified by DNV

---

### ISO/TS 16949

Microchip received ISO/TS-16949:2009 certification for its worldwide headquarters, design and wafer fabrication facilities in Chandler and Tempe, Arizona; Gresham, Oregon and design centers in California and India. The Company's quality system processes and procedures are for its PIC<sup>®</sup> MCUs and dsPIC<sup>®</sup> DSCs, KEELOQ<sup>®</sup> code hopping devices, Serial EEPROMs, microperipherals, nonvolatile memory and analog products. In addition, Microchip's quality system for the design and manufacture of development systems is ISO 9001:2000 certified.

## Worldwide Sales and Service

AMERICAS	ASIA/PACIFIC	ASIA/PACIFIC	EUROPE
<p><b>Corporate Office</b> 2355 West Chandler Blvd. Chandler, AZ 85224-6199 Tel: 480-792-7200 Fax: 480-792-7277 Technical Support: <a href="http://www.microchip.com/support">http://www.microchip.com/support</a> Web Address: <a href="http://www.microchip.com">www.microchip.com</a></p> <p><b>Atlanta</b> Duluth, GA Tel: 678-957-9614 Fax: 678-957-1455</p> <p><b>Austin, TX</b> Tel: 512-257-3370</p> <p><b>Boston</b> Westborough, MA Tel: 774-760-0087 Fax: 774-760-0088</p> <p><b>Chicago</b> Itasca, IL Tel: 630-285-0071 Fax: 630-285-0075</p> <p><b>Dallas</b> Addison, TX Tel: 972-818-7423 Fax: 972-818-2924</p> <p><b>Detroit</b> Novi, MI Tel: 248-848-4000</p> <p><b>Houston, TX</b> Tel: 281-894-5983</p> <p><b>Indianapolis</b> Noblesville, IN Tel: 317-773-8323 Fax: 317-773-5453 Tel: 317-536-2380</p> <p><b>Los Angeles</b> Mission Viejo, CA Tel: 949-462-9523 Fax: 949-462-9608 Tel: 951-273-7800</p> <p><b>Raleigh, NC</b> Tel: 919-844-7510</p> <p><b>New York, NY</b> Tel: 631-435-6000</p> <p><b>San Jose, CA</b> Tel: 408-735-9110 Tel: 408-436-4270</p> <p><b>Canada - Toronto</b> Tel: 905-695-1980 Fax: 905-695-2078</p>	<p><b>Australia - Sydney</b> Tel: 61-2-9868-6733</p> <p><b>China - Beijing</b> Tel: 86-10-8569-7000</p> <p><b>China - Chengdu</b> Tel: 86-28-8665-5511</p> <p><b>China - Chongqing</b> Tel: 86-23-8980-9588</p> <p><b>China - Dongguan</b> Tel: 86-769-8702-9880</p> <p><b>China - Guangzhou</b> Tel: 86-20-8755-8029</p> <p><b>China - Hangzhou</b> Tel: 86-571-8792-8115</p> <p><b>China - Hong Kong SAR</b> Tel: 852-2943-5100</p> <p><b>China - Nanjing</b> Tel: 86-25-8473-2460</p> <p><b>China - Qingdao</b> Tel: 86-532-8502-7355</p> <p><b>China - Shanghai</b> Tel: 86-21-3326-8000</p> <p><b>China - Shenyang</b> Tel: 86-24-2334-2829</p> <p><b>China - Shenzhen</b> Tel: 86-755-8864-2200</p> <p><b>China - Suzhou</b> Tel: 86-186-6233-1526</p> <p><b>China - Wuhan</b> Tel: 86-27-5980-5300</p> <p><b>China - Xian</b> Tel: 86-29-8833-7252</p> <p><b>China - Xiamen</b> Tel: 86-592-2388138</p> <p><b>China - Zhuhai</b> Tel: 86-756-3210040</p>	<p><b>India - Bangalore</b> Tel: 91-80-3090-4444</p> <p><b>India - New Delhi</b> Tel: 91-11-4160-8631</p> <p><b>India - Pune</b> Tel: 91-20-4121-0141</p> <p><b>Japan - Osaka</b> Tel: 81-6-6152-7160</p> <p><b>Japan - Tokyo</b> Tel: 81-3-6880-3770</p> <p><b>Korea - Daegu</b> Tel: 82-53-744-4301</p> <p><b>Korea - Seoul</b> Tel: 82-2-554-7200</p> <p><b>Malaysia - Kuala Lumpur</b> Tel: 60-3-7651-7906</p> <p><b>Malaysia - Penang</b> Tel: 60-4-227-8870</p> <p><b>Philippines - Manila</b> Tel: 63-2-634-9065</p> <p><b>Singapore</b> Tel: 65-6334-8870</p> <p><b>Taiwan - Hsin Chu</b> Tel: 886-3-577-8366</p> <p><b>Taiwan - Kaohsiung</b> Tel: 886-7-213-7830</p> <p><b>Taiwan - Taipei</b> Tel: 886-2-2508-8600</p> <p><b>Thailand - Bangkok</b> Tel: 66-2-694-1351</p> <p><b>Vietnam - Ho Chi Minh</b> Tel: 84-28-5448-2100</p>	<p><b>Austria - Wels</b> Tel: 43-7242-2244-39 Fax: 43-7242-2244-393</p> <p><b>Denmark - Copenhagen</b> Tel: 45-4450-2828 Fax: 45-4485-2829</p> <p><b>Finland - Espoo</b> Tel: 358-9-4520-820</p> <p><b>France - Paris</b> Tel: 33-1-69-53-63-20 Fax: 33-1-69-30-90-79</p> <p><b>Germany - Garching</b> Tel: 49-8931-9700</p> <p><b>Germany - Haan</b> Tel: 49-2129-3766400</p> <p><b>Germany - Heilbronn</b> Tel: 49-7131-67-3636</p> <p><b>Germany - Karlsruhe</b> Tel: 49-721-625370</p> <p><b>Germany - Munich</b> Tel: 49-89-627-144-0 Fax: 49-89-627-144-44</p> <p><b>Germany - Rosenheim</b> Tel: 49-8031-354-560</p> <p><b>Israel - Ra'anana</b> Tel: 972-9-744-7705</p> <p><b>Italy - Milan</b> Tel: 39-0331-742611 Fax: 39-0331-466781</p> <p><b>Italy - Padova</b> Tel: 39-049-7625286</p> <p><b>Netherlands - Drunen</b> Tel: 31-416-690399 Fax: 31-416-690340</p> <p><b>Norway - Trondheim</b> Tel: 47-72884388</p> <p><b>Poland - Warsaw</b> Tel: 48-22-3325737</p> <p><b>Romania - Bucharest</b> Tel: 40-21-407-87-50</p> <p><b>Spain - Madrid</b> Tel: 34-91-708-08-90 Fax: 34-91-708-08-91</p> <p><b>Sweden - Gothenberg</b> Tel: 46-31-704-60-40</p> <p><b>Sweden - Stockholm</b> Tel: 46-8-5090-4654</p> <p><b>UK - Wokingham</b> Tel: 44-118-921-5800 Fax: 44-118-921-5820</p>