

Data sheet | Item number: 2092-3124

1-conductor female connector; push-button; Push-in CAGE CLAMP®; 2.5 mm²; Pin spacing 7.5 mm; 4-pole; 2,50 mm²; light gray

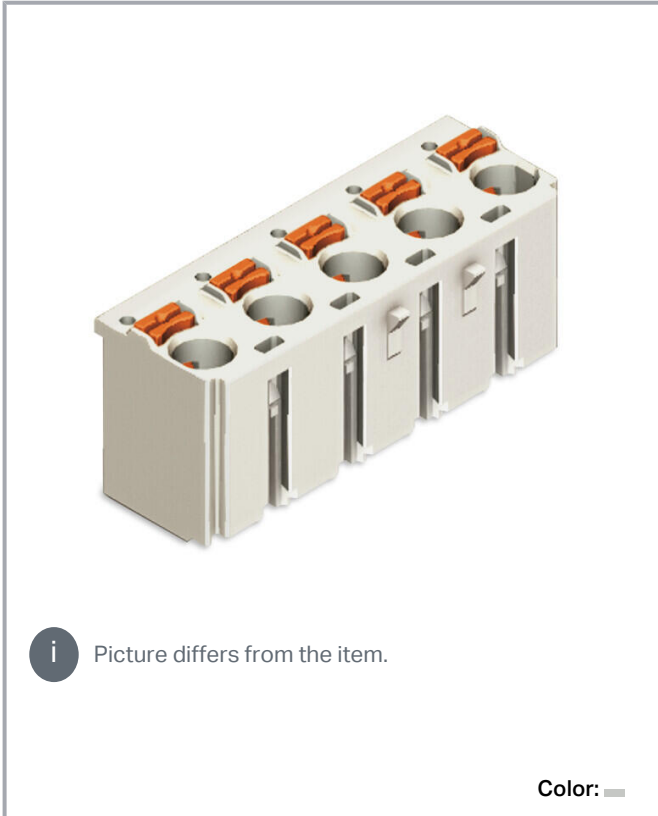

www.wago.com/2092-3124



Subject to changes. Please also observe the further product documentation!

WAGO GmbH & Co. KG
Hansastr. 27
32423 Minden
Phone: +49571 887-0 | Fax: +49571 887-169
Email: info.de@wago.com | Web: www.wago.com

Do you have any questions about our products?
We are always happy to take your call at +49 (571) 887-44222.

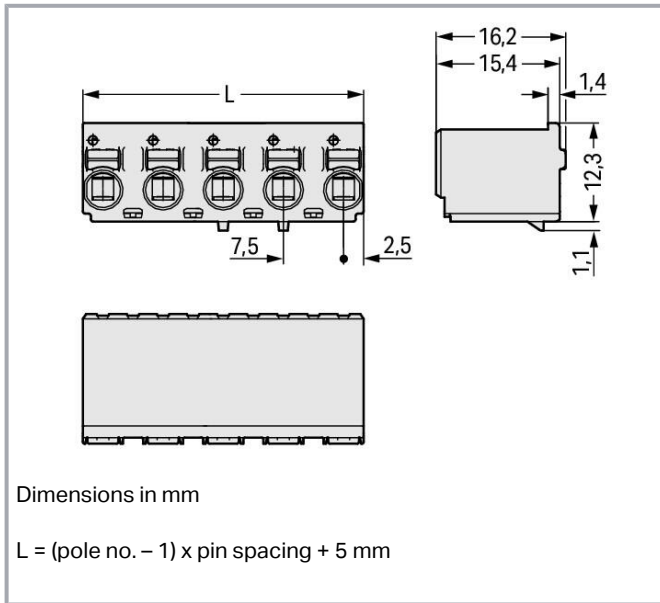

Item description

- Universal connection of all conductor types
- Simple, push-in termination of solid and ferruled conductors
- Easy-to-use design does not require special tools
- Ability to wire while mated or unmated
- Testing parallel to conductor entry – tip contact
- Also available with gripping plates
- Integrated locking latches prevent accidental disconnection

Data

Notes

Safety information

The **picoMAX® Pluggable Connection System** includes connectors without breaking capacity in accordance with DIN EN 61984. When used as intended, these connectors must not be connected /disconnected when live or under load. The circuit design should ensure header pins, which can be touched, are not live when unmated.

Variants:

Direct marking

Other versions (or variants) can be requested from WAGO Sales or configured at <https://configurator.wago.com/>.

Electrical data

Subject to changes. Please also observe the further product documentation!



Ratings per IEC/EN

Ratings per	IEC/EN 60664-1
Nominal voltage (III/3)	400 V
Rated impulse voltage (III/3)	6 kV
Rated voltage (III/2)	630 V
Rated impulse voltage (III/2)	6 kV
Nominal voltage (II/2)	1000 V
Rated surge voltage (II/2)	6 kV
Rated current	16 A
Legend (ratings)	(III / 2) ≙ Overvoltage category III / Pollution degree 2

Ratings per UL 1059

Approvals per	UL 1059
Rated voltage UL (Use Group B)	300 V
Rated current UL (Use Group B)	15 A
Rated voltage UL (Use Group D)	300 V
Rated current UL (Use Group D)	10 A

Connection data

Connection points	4
Total number of potentials	4
Number of connection types	1
Number of levels	1

Connection 1

Connection technology	Push-in CAGE CLAMP®
Actuation type	Push-button
Actuation direction 1	Operation parallel to conductor entry
Solid conductor	0.2 ... 2.5 mm ² / 24 ... 12 AWG
Fine-stranded conductor	0.2 ... 2.5 mm ² / 24 ... 12 AWG
Fine-stranded conductor; with insulated ferrule	0.25 ... 1.5 mm ²
Fine-stranded conductor; with uninsulated ferrule	0.25 ... 2.5 mm ²
Strip length	9 ... 10 mm / 0.35 ... 0.39 inches
Pole number	4

Subject to changes. Please also observe the further product documentation!



Physical data

Pin spacing	7.5 mm / 0.295 inches
Width	27.5 mm / 1.083 inches
Height	16.2 mm / 0.638 inches
Depth	13.4 mm / 0.528 inches

Mechanical Data

Variable coding	Yes
Anti-rotation protection	Yes

Plug-in connection

Contact type (pluggable connector)	Female connector/socket
Connector (connection type)	for conductor
Mismating protection	No
Plugging without loss of pin spacing	Yes
Locking of plug-in connection	none

Material Data

Note (material data)	Information on material specifications can be found here
Color	light gray
Material group	I
Insulation material	Polyphthalamide (PPA GF)
Flammability class per UL94	V0
Clamping spring material	Chrome-nickel spring steel (CrNi)
Contact material	Electrolytic copper (E _{Cu})
Contact plating	Tin
Fire load	0.01 MJ
Weight	4.6 g

Environmental requirements

Limit temperature range	-60 ... +100 °C
Processing temperature	-35 ... +60 °C

Subject to changes. Please also observe the further product documentation!

WAGO GmbH & Co. KG
 Hansastr. 27
 32423 Minden
 Phone: +49571 887-0 | Fax: +49571 887-169
 Email: info.de@wago.com | Web: www.wago.com

Do you have any questions about our products?
 We are always happy to take your call at +49 (571) 887-44222.

Commercial data





Product Group	26 (picoMAX Connectors)
eCl@ss 10.0	27-14-11-06
eCl@ss 9.0	27-14-11-06
ETIM 8.0	EC001284
ETIM 7.0	EC001284
PU (SPU)	100 pcs
Packaging type	box
Country of origin	DE
GTIN	4050821164418
Customs tariff number	85366990990

Environmental Product Compliance

RoHS Compliance Status	Compliant, No Exemption
------------------------	-------------------------













Approvals / Certificates

General approvals



Logo	Approval	Additional Approval Text	Certificate name
	CB DEKRA Certification B.V.	IEC 61984	NL-49737 /A1
	CSA DEKRA Certification B.V.	C22.2 No. 158	2362521
	CSA DEKRA Certification B.V.	C22.2	2362521
	cURus Underwriters Laboratories Inc.	UL 1059	E45172
	UL Underwriters Laboratories Inc.	UL 1977	E45171

Subject to changes. Please also observe the further product documentation!

Counterpart



	Item no.2092-3404 THT male header; 1.4 mm Ø solder pin; straight; Pin spacing 7.5 mm; 4-pole; light gray	www.wago.com/2092-3404
	Item no.2092-3404/200-000 THR male header; 1.4 mm Ø solder pin; straight; Pin spacing 7.5 mm; 4-pole; light gray	www.wago.com/2092-3404/200-000
	Item no.2092-3404/005-000 THT male header; 1.4 mm Ø solder pin; straight; clamping collar; Pin spacing 7.5 mm; 4-pole; light gray	www.wago.com/2092-3404/005-000
	Item no.2092-3404/205-000 THR male header; 1.4 mm Ø solder pin; straight; clamping collar; Pin spacing 7.5 mm; 4-pole; light gray	www.wago.com/2092-3404/205-000
	Item no.2092-3424 THT male header; 1.4 mm Ø solder pin; angled; Pin spacing 7.5 mm; 4-pole; light gray	www.wago.com/2092-3424
	Item no.2092-3424/200-000 THR male header; 1.4 mm Ø solder pin; angled; Pin spacing 7.5 mm; 4-pole; light gray	www.wago.com/2092-3424/200-000
	Item no.2092-3424/205-000 THR male header; 1.4 mm Ø solder pin; angled; clamping collar; Pin spacing 7.5 mm; 4-pole; light gray	www.wago.com/2092-3424/205-000
	Item no.2092-3424/005-000 THT male header; 1.4 mm Ø solder pin; angled; clamping collar; Pin spacing 7.5 mm; 4-pole; light gray	www.wago.com/2092-3424/005-000
	Item no.2092-3504/002-000 1-conductor male connector; Push-in CAGE CLAMP®; 2.5 mm²; Pin spacing 7.5 mm; 4-pole; Gripping plate; 2,50 mm²; light gray	www.wago.com/2092-3504/002-000
	Item no.2092-3524/002-000 1-conductor male connector; Push-in CAGE CLAMP®; 2.5 mm²; Pin spacing 7.5 mm; 4-pole; Integrated release lever; 2,50 mm²; light gray	www.wago.com/2092-3524/002-000
	Item no.2092-3524/020-000 1-conductor male connector; Push-in CAGE CLAMP®; 2.5 mm²; Pin spacing 7.5 mm; 4-pole; DIN-35 rail/panel mounting; Snap-in mounting feet; Integrated release lever; 2,50 mm²; light gray	www.wago.com/2092-3524/020-000
	Item no.2092-3704 THT male header; 1.4 mm Ø solder pin; straight; Pin spacing 7.5 mm; 4-pole; black	www.wago.com/2092-3704

Subject to changes. Please also observe the further product documentation!



	Item no.2092-3704/200-000 THR male header; 1.4 mm Ø solder pin; straight; Pin spacing 7.5 mm; 4-pole; black	www.wago.com/2092-3704/200-000
	Item no.2092-3724 THT male header; 1.4 mm Ø solder pin; angled; Pin spacing 7.5 mm; 4-pole; black	www.wago.com/2092-3724
	Item no.2092-3724/200-000 THR male header; 1.4 mm Ø solder pin; angled; Pin spacing 7.5 mm; 4-pole; black	www.wago.com/2092-3724/200-000

Optional accessories

Strain relief

Strain relief plate		
	Item no.: 2092-3602 Gripping plate; for female and male connectors; 1 part; Pin spacing 7.5 mm; light gray	www.wago.com/2092-3602
	Item no.: 2092-3602/002-000 Gripping plate with sliding connector release; for female and male connectors; 2 parts; Pin spacing 7.5 mm; light gray	www.wago.com/2092-3602/002-000

Tool

Operating tool		
	Item no.: 2092-1630 Unlocking tool; orange	www.wago.com/2092-1630
	Item no.: 210-719 Operating tool; Blade: 2.5 x 0.4 mm; with a partially insulated shaft	www.wago.com/210-719

Testing and measuring

Testing accessories		
	Item no.: 735-500 WAGO Test pin; 1 mm Ø; 30 V AC / 60 V DC; CAT0; 1 A; 6 mm uninsulated; Test lead for soldering up to 0,5mm ²	www.wago.com/735-500

Downloads

Documentation

Additional Information

Technical Section	2019 Apr 3	pdf	Download
Technical explanations		2.0 MB	

CAD/CAE-Data

CAE data

Subject to changes. Please also observe the further product documentation!

WAGO GmbH & Co. KG
 Hansastr. 27
 32423 Minden
 Phone: +49571 887-0 | Fax: +49571 887-169
 Email: info.de@wago.com | Web: www.wago.com

Do you have any questions about our products?
 We are always happy to take your call at +49 (571) 887-44222.

ZUKEN Portal 2092-3124

[URL](#)

[Download](#)

CAD data

2D/3D Models 2092-3124

[URL](#)

[Download](#)

Environmental Product Compliance

Compliance Search

Environmental Product Compliance 2092-3124

[URL](#)

[Download](#)

1-conductor female connector; push-button; Push-in CAGE CLAMP®; 2.5 mm²; Pin spacing 7.5 mm; 4-pole; 2,50 mm²; light gray

Installation Notes

Locking system

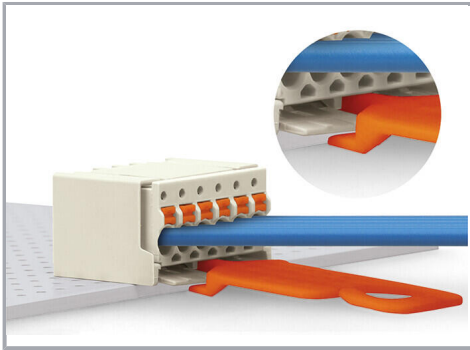

Disconnecting a female connector via unlocking tool. Plug unlocking tool into the male header's locking latch.

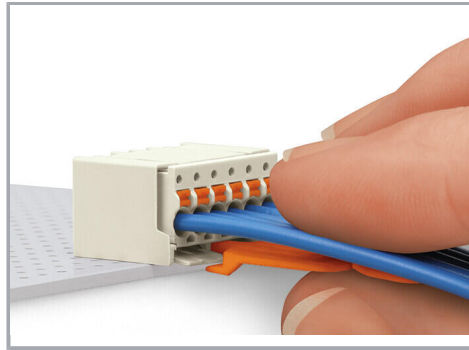

Insert unlocking tool until it hits the backstop. Wedge opens locking latches.

Subject to changes. Please also observe the further product documentation!

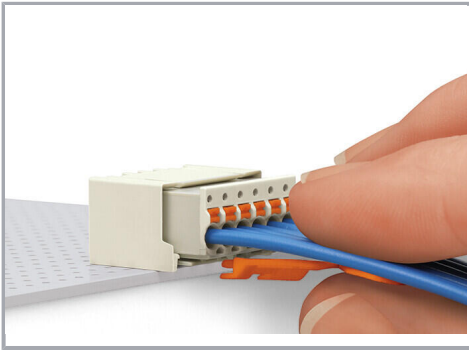

Pull on both unlocking tool and conductors to remove female connector from male header.

Conductor termination

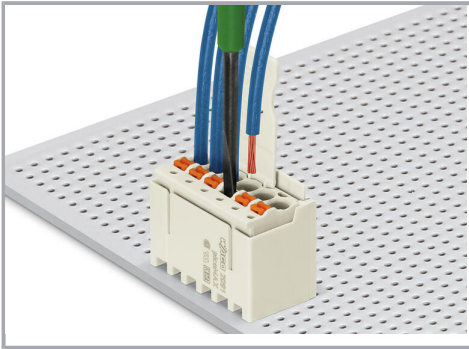

Inserting fine-stranded conductor into mated female connector via push-button.

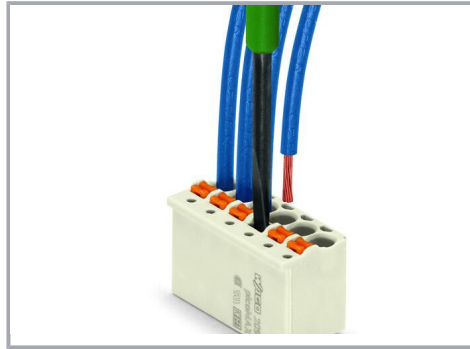

Inserting a fine-stranded conductor into an unmated female connector via push-button.

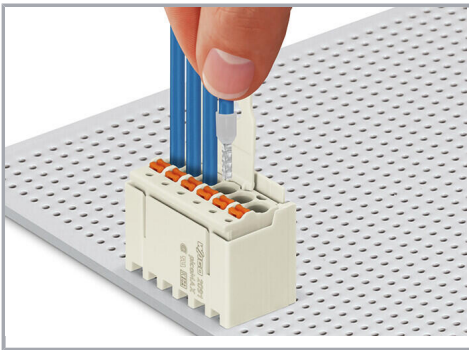

Inserting solid and ferruled conductors via push-in termination.

Marking

Subject to changes. Please also observe the further product documentation!



Pole marking via factory direct marking.

Coding

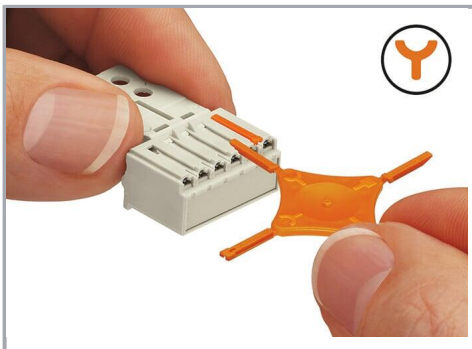

Coding a female connector (via coding key carrier and two keys for female connector, see symbol).

Testing

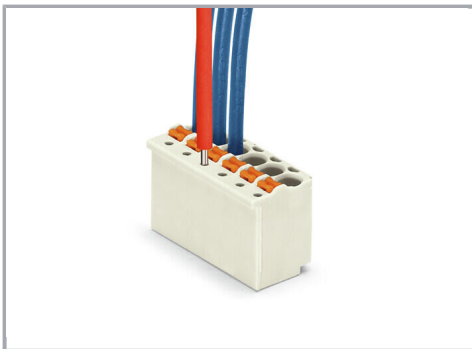

Testing via 1 mm Ø test pin – touch contact.

Subject to changes. Please also observe the further product documentation!