

Printed-circuit board connector - DMCV 1,5/16-G1F-3,5-LR P20THR - 1787535

Please be informed that the data shown in this PDF Document is generated from our Online Catalog. Please find the complete data in the user's documentation. Our General Terms of Use for Downloads are valid (<http://phoenixcontact.com/download>)

PCB headers, nominal current: 8 A, number of positions: 16, pitch: 3.5 mm, color: black, contact surface: Tin, mounting: THR soldering



The figure shows a 10-pos. version with 20 contacts

Your advantages

- ✓ Designed for integration into the SMT soldering process
- ✓ Vertical connection enables multi-row arrangement on the PCB
- ✓ Screwable flange for superior mechanical stability
- ✓ Automatic locking and intuitive release through Lock and Release operating lever in contrasting color
- ✓ Small component size for applications where space is at a premium



Key Commercial Data

Packing unit	50 pc
Minimum order quantity	50 pc
GTIN	 4 046356 597159
GTIN	4046356597159

Technical data

Dimensions

Length [l]	10.6 mm
Width	63 mm
Pitch	3.5 mm
Dimension a	52.5 mm
Width [w]	63 mm
Height [h]	12 mm
Height	10 mm
Length of the solder pin	2 mm

Printed-circuit board connector - DMCV 1,5/16-G1F-3,5-LR P20THR - 1787535

Technical data

Dimensions

Pin dimensions	0.8 x 0.8 mm
Pin spacing	5.50 mm
Length	10.6 mm

General

Range of articles	DMCV 1,5/..-G1F-THR
Insulating material group	IIIa
Rated surge voltage (III/3)	2.5 kV
Rated surge voltage (III/2)	2.5 kV
Rated surge voltage (II/2)	2.5 kV
Rated voltage (III/3)	160 V
Rated voltage (III/2)	160 V
Rated voltage (II/2)	250 V
Connection in acc. with standard	EN-VDE
Nominal current I_N	8 A
Maximum load current	8 A
Insulating material	LCP
Flammability rating according to UL 94	V0
Color	black
Number of positions	16

Standards and Regulations

Connection in acc. with standard	EN-VDE
	CUL
Flammability rating according to UL 94	V0

Environmental Product Compliance

China RoHS	Environmentally friendly use period: unlimited = EFUP-e
	No hazardous substances above threshold values

Drawings

Printed-circuit board connector - DMCV 1,5/16-G1F-3,5-LR P20THR - 1787535

Drilling diagram

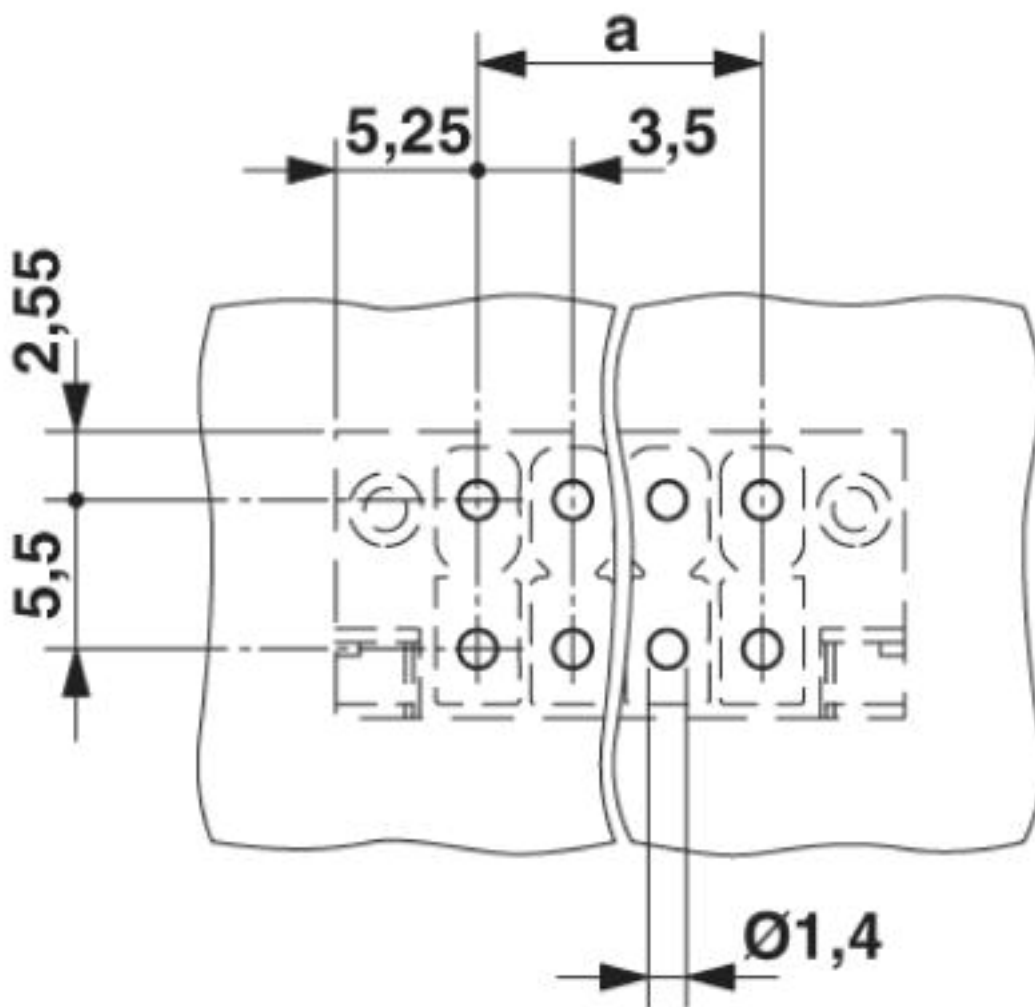

Printed-circuit board connector - DMCV 1,5/16-G1F-3,5-LR P20THR - 1787535

Diagram

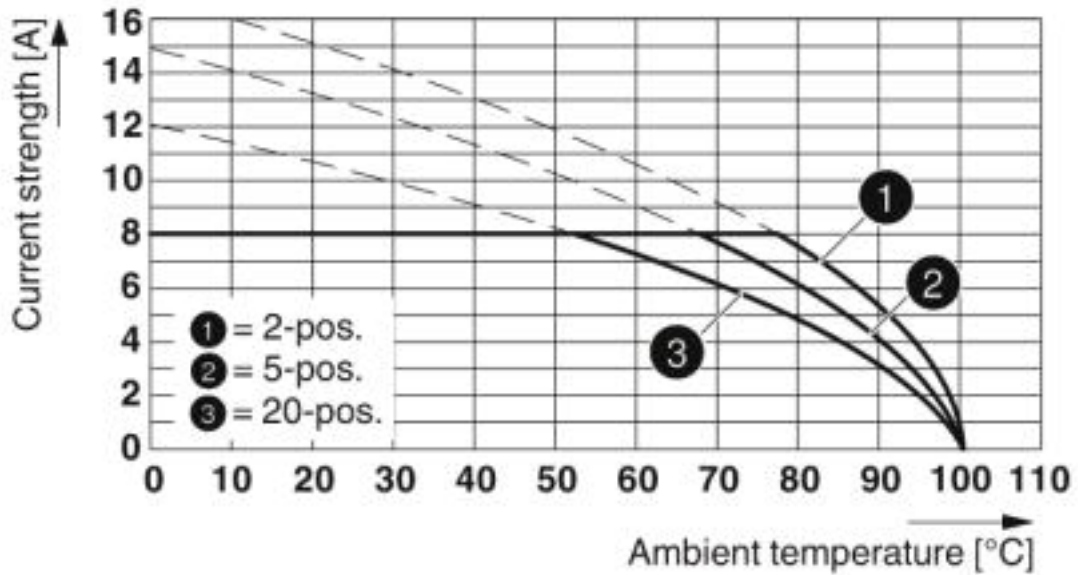

Type: DFMC 1,5/...-STF-3,5 with DMCV 1,5/...-G1F-3,5-LR P...THR

Dimensional drawing

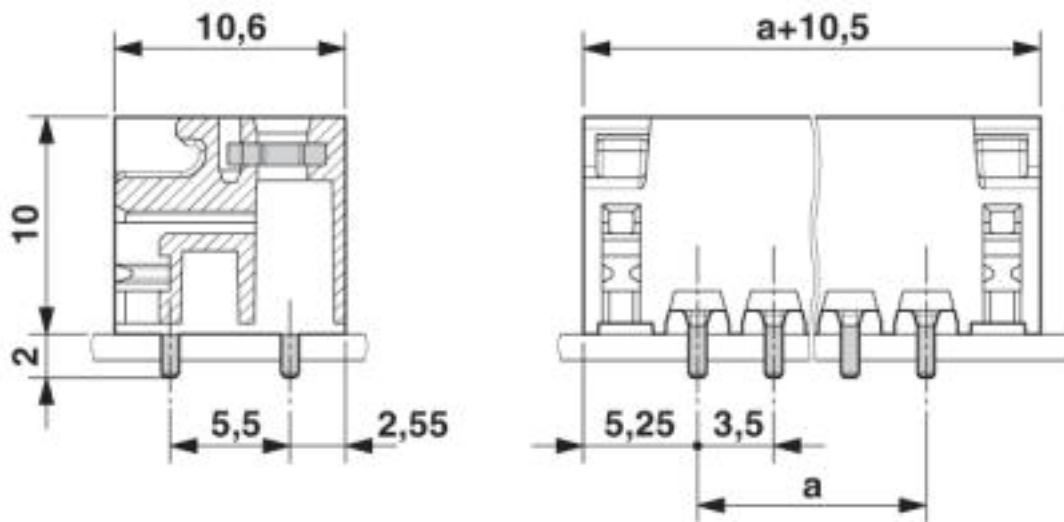

Printed-circuit board connector - DMCV 1,5/16-G1F-3,5-LR P20THR - 1787535

Schematic diagram

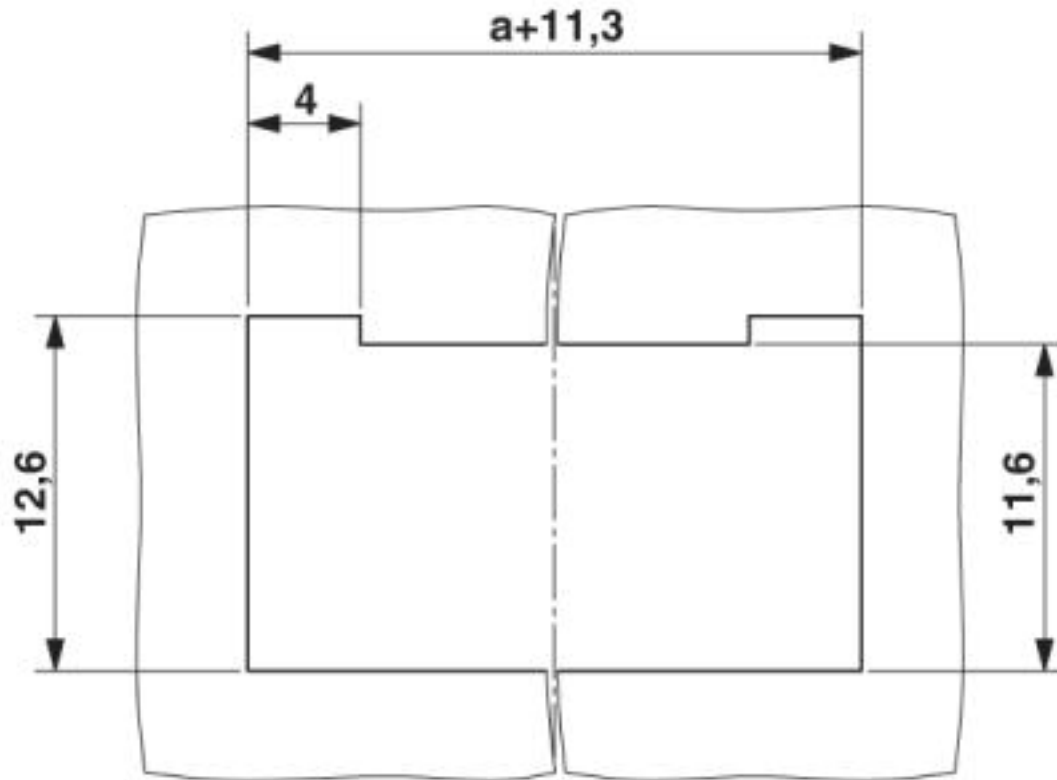

Panel cutout

Printed-circuit board connector - DMCV 1,5/16-G1F-3,5-LR P20THR - 1787535

Schematic diagram

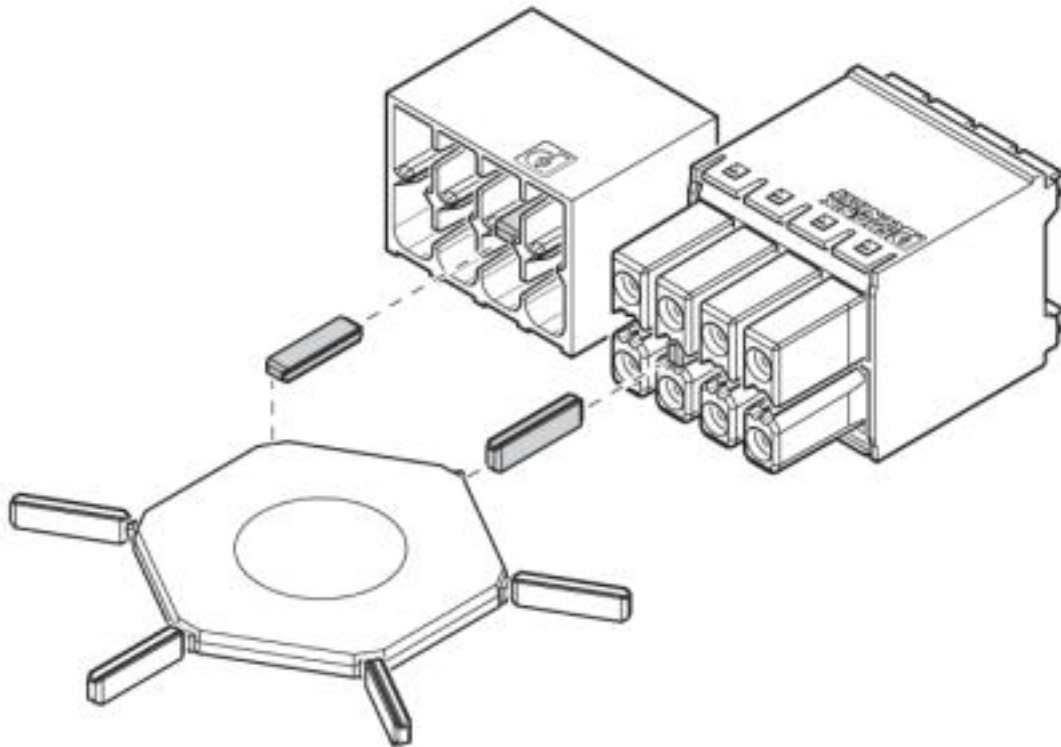

Use of the CP-DMC... coding profile

Approvals

Approvals

Approvals

IECEE CB Scheme / VDE Gutachten mit Fertigungsüberwachung / EAC / cULus Recognized

Ex Approvals

Approval details

IECEE CB Scheme	CB scheme	http://www.iecee.org/	DE1-60359_B1_B2
Nominal voltage UN	160 V		
Nominal current IN	8 A		

Printed-circuit board connector - DMCV 1,5/16-G1F-3,5-LR P20THR - 1787535

Approvals

VDE Gutachten mit Fertigungsüberwachung		http://www2.vde.com/de/Institut/Online-Service/ VDE-gepruefteProdukte/Seiten/Online-Suche.aspx	40038423
Nominal voltage UN		160 V	
Nominal current IN		8 A	

EAC		B.01742
-----	---	---------

cULus Recognized		http://database.ul.com/cgi-bin/XYV/template/LISEXT/1FRAME/index.htm	E60425-20110128
	B	C	D
Nominal voltage UN	300 V	50 V	300 V
Nominal current IN	8 A	8 A	8 A

Phoenix Contact 2019 © - all rights reserved
<http://www.phoenixcontact.com>

PHOENIX CONTACT GmbH & Co. KG
Flachsmarktstr. 8
32825 Blomberg
Germany
Tel. +49 5235 300
Fax +49 5235 3 41200
<http://www.phoenixcontact.com>