

50 Ohm SMB Right Angle Solder Type Plug - Captivated Contact

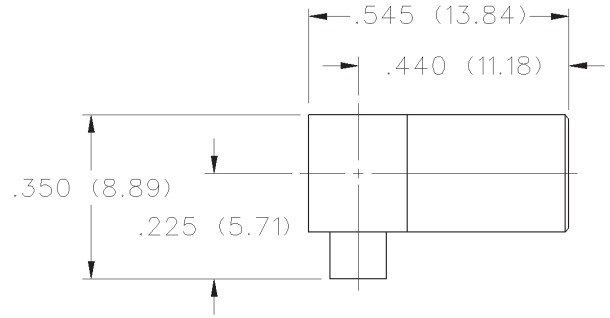

INCHES (MILLIMETERS)
CUSTOMER DRAWINGS AVAILABLE UPON REQUEST



CABLE TYPE	GOLD PLATED	NICKEL PLATED
.086 Semi-Rigid	131-3693-101	131-3693-116

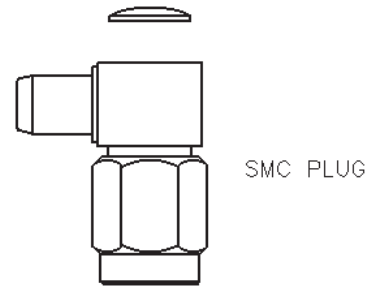
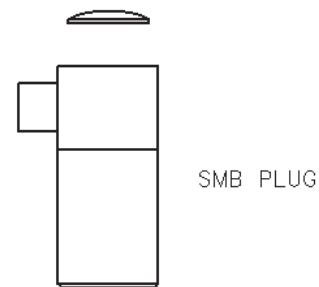
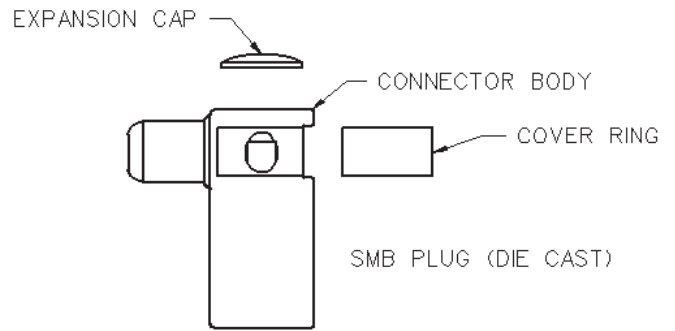
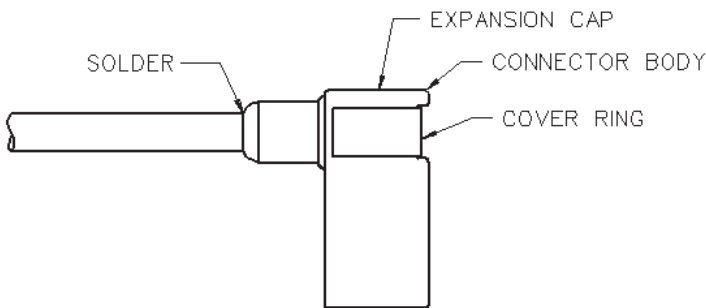
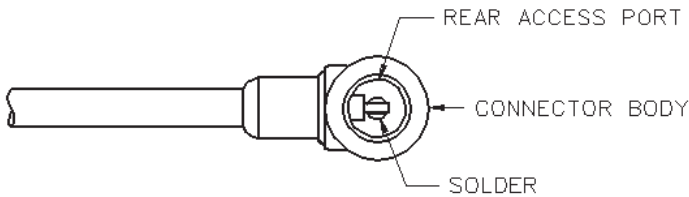
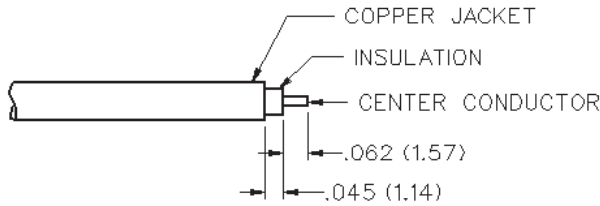

1. Identify connector parts. (2 piece parts - except diecast)
2. Strip cable to dimensions shown. Do not nick center conductor.
3. Insert cable into body making certain that the cable insulation bottoms on center contact. Solder center conductor to contact through the rear and side access ports. Use a minimum amount of solder for a good joint. **.020 (0.51) diameter solder is recommended.**
4. Solder body to cable. Use a minimum amount of heat to minimize cable insulation movement. Place expansion cap in access port and set with .125 (3.17) diameter punch. Snap cover ring over side access port.

CABLE GROUP	PART NUMBER
RG-405/u	131-3693-101
(.086 semi-rigid)	131-3693-116

SMB - 50 Ohm Connectors

Specifications



INCHES (MILLIMETERS)
CUSTOMER DRAWINGS AVAILABLE UPON REQUEST

ELECTRICAL RATINGS

Impedance: 50 ohms

Frequency Range: Connectors 0-4 GHz
Dummy loads 0-1 GHz

VSWR: (f = GHz)

	Straight Cabled	Right Angle Cabled
RG-178 cable	1.30 + .04f	1.45 + .06f
RG-316, RG-58, and .086 semi-rigid cable	1.25 + .04f	1.35 + .04f
Adapters	1.20 + .04f	
Uncabled receptacles, dummy loads	N/A	

Working Voltage: (Vrms maximum)†

Connectors for Cable Type	Sea Level	70K Feet
RG-178	250	60
RG-316, RG-58, .086 semi-rigid uncabled receptacles, adapters	335	85
Dummy loads	N/A	

Dielectric Withstanding Voltage: (VRMS minimum at sea level)†

Connectors for RG-178	750
Connectors for RG-316, RG-58, .086 semi-rigid, uncabled receptacles, adapters	1000
Dummy loads	N/A

Corona Level: (Volts minimum at 70,000 feet)†

Connectors for RG-178	185
Connectors for RG-316, RG-58, .086 semi-rigid	250
Uncabled receptacles, adapters, dummy loads	N/A

Insertion Loss: (dB maximum, tested at 1.5 GHz)

Straight cable connectors	0.30 dB
Right angle cable connectors	0.60 dB
Uncabled receptacles, adapters and dummy loads	N/A

Insulation Resistance: 1000 megohms minimum

Contact Resistance: (milliohms maximum)	Initial	After Environmental
Center contact (straight cabled connectors and uncabled receptacles)	6.0	8.0
Center contact (right angle cabled connectors and adapters)	12.0	16.0
Outer contact (gold plated connectors)	1.0	1.5
Outer contact (nickel plated connectors)	2.5	3.5
Braid to body (gold plated connectors)	1.0	N/A
Braid to body (nickel plated connectors)	2.5	N/A

RF Leakage: (dB minimum tested at 2.5 GHz)

Cable connectors	-55 dB
Uncabled receptacles, adapters and dummy loads	N/A

RF High Potential Withstanding Voltage: (Vrms minimum, tested at 4 and 7 MHz)†

Connectors for RG-178	500
Connectors for RG-316, RG-58	700
Uncabled receptacles and adapters	600
Dummy loads	N/A

Power Rating (Dummy Load): 0.5 watt @ +25°C, derated to 0.25 watt @ +125° C

MECHANICAL RATINGS

Engagement Design: MIL-C-39012, Series SMB

Engagement/Disengagement Force: 2 pounds min to 14 pounds maximum axial force

Contact Retention: 4 lbs. min axial force (captivated contacts)

1 inch-ounce min torque (uncabled receptacles)

Cable Retention: Axial Force* (pounds) Torque (in-oz)

Connectors for RG-178	10	N/A
Connectors for RG-316	20	N/A
Connectors for RG-58	40	16
Connectors for .086 semi-rigid	30	16

* or cable breaking strength whichever is less.

Durability: 500 cycles minimum

ENVIRONMENTAL RATINGS

(Meets or exceed the applicable paragraph of MIL-C-39012)

Temperature Range: Connectors	- 65°C to + 165°C
Dummy loads	- 65°C to + 125°C

Thermal Shock: MIL-STD-202, Method 107, Condition B (N/A dummy loads)

Corrosion: MIL-STD-202, Method 101, Condition B (N/A dummy loads)

Shock: MIL-STD-202, Method 213, Condition B (N/A dummy loads)

Vibration: MIL-STD-202, Method 204, Condition B (N/A dummy loads)

MATERIAL SPECIFICATIONS

Bodies: Brass per QQ-B-626 or zinc per ASTM B86-71, gold plated** per MIL-G-45204 .00001 min or nickel plated per QQ-N-290

Contacts: Male - brass per QQ-B-626, gold plated per MIL-G-45204 .00003" min.

Female - beryllium copper per QQ-C-530, gold plated per MIL-G-45204 .00003" min.

Insulators: PTFE fluorocarbon per ASTM D 1710 and ASTM D 1457 OR Teflon PFA 340

Expansion Caps: Brass per QQ-B-613, gold plated per MIL-G-45204 .00001" min. or nickel plated per QQ-N-290

Crimp Sleeves: Copper per WW-T-799, gold plated per MIL-G-45204 .00001" min. or nickel plated per QQ-N-290

Mounting Hardware: Brass (nuts) per QQ-B-626 or phosphor bronze (lockwashers) QQ-B-750, gold plated per MIL-G-45204 .00001" min. or nickel plated per QQ-N-290

Cover Rings: Phosphor Bronze per QQ-B-750, gold plated per MIL-G-45204 .00001 min. or nickel plated per QQ-N-290.

†Avoid user injury due to misapplication. See safety advisory definitions inside front cover.

** All gold plated parts include a .00005" min. nickel underplate barrier layer.

MATING ENGAGEMENT FOR SMB SERIES PER MIL-C-39012

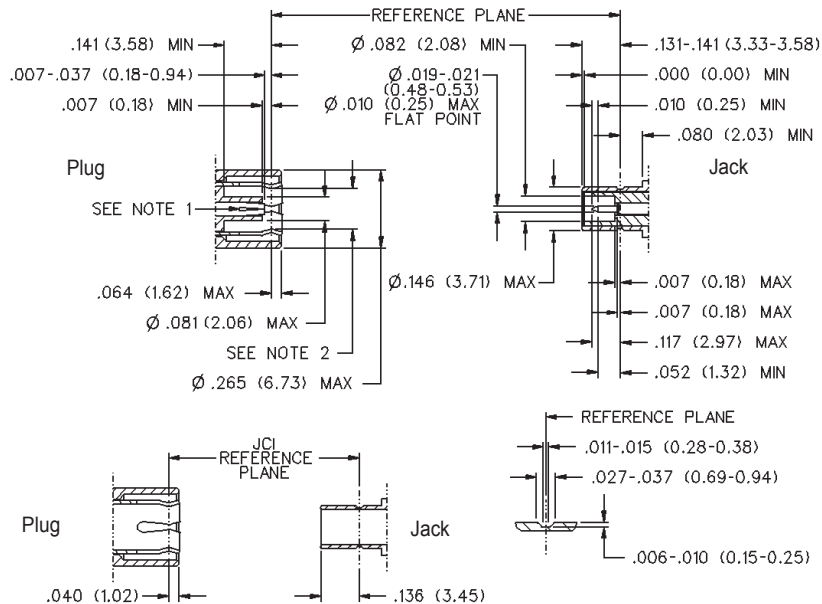

Notes

1. ID of contact to meet VSWR mating characteristics and connector durability when mated with a dia .019 / 0.53 male contact.
2. Must meet the force to engage and disengage when mated with mating part.