

Marvelmind Indoor Navigation System

Operating manual

v2023_03_28

www.marvelmind.com

Contents

- 1. Executive summary 13
 - 1.1. Key capabilities: 14
 - 1.2. Legend 15
- 2. Basics of the system 16
 - 2.1. What’s in the box 16
 - 2.1.1. Starter Set Super-MP-3D:..... 16
 - 2.1.2. Starter Set IA-04-2D-Badge: 17
 - 2.2. Indoor Navigation System architectures 18
 - 2.2.1. Inverse Architecture 19
 - 2.2.2. Non-Inverse Architecture (NIA) 20
 - 2.2.3. Multi-Frequency NIA (MF NIA) 21
 - 2.2.4. Architectures comparison table 22
 - 2.3. Architectures’ elements 23
 - 2.4. Indoor “GPS” System close-up and internal view 24
- 3. System elements 28
 - 3.1. Control system (Dashboard) 28
 - 3.2. Stationary beacon 29
 - 3.3. Mobile beacon a.k.a. “hedgehog” 30
 - 3.4. Modem 31
 - 3.5. Different types of modems 32
 - 3.5.1. Super-Modem 32
 - 3.5.2. Modem HW v5.1 34
 - 3.5.3. Modem HW v4.9 35
 - 3.6. Different types of beacons 36
 - 3.6.1. Super-Beacon 37
 - 3.6.2. Beacon Mini-RX 45
 - 3.6.3. Beacon Mini-TX 52
 - 3.6.4. Beacon Industrial-TX-Metal 53
 - 3.6.5. Beacon Industrial-RX 55
 - 3.6.6. Industrial Super-Beacon Metal-25kHz 58
 - 3.6.7. Beacon HW v4.9 60
- 4. Software pack 61
 - 4.1. Download and open 62
 - 4.2. Dashboard folder 63
 - 4.3. Software IA folder 64
 - 4.3.1. Types of Industrial-Super-Beacons: 66
 - 4.4. Software NIA folder 67
 - 4.5. Super-Modem folder 69
- 5. SW settings descriptions 70
 - 5.1. Super-Modem’s SW update and configuration description 70

5.1.1.	Super-Modem's SW update.....	70
5.1.2.	How to update Super-Modem (for SW version from v7.000)	71
5.1.3.	How to update Super-Modem's SW (for SW version older than v7.000):	73
5.1.4.	Super-Modem's configuration.....	74
5.2.	SW update (USB/Radio/DFU)	76
5.2.1.	SW update via USB	76
5.2.2.	SW update via Radio	78
5.2.3.	SW update via DFU Programming	79
6.	Setting up the system	86
6.1.	Introduction	86
6.2.	DIP switch positions.....	87
6.2.1.	DIP switch position for OFF beacon	87
6.2.2.	DIP switch position for work and HEX programming.....	87
6.2.3.	DIP switch position for DFU programming	87
6.3.	Starter Set Super-MP-3D (NIA and IA).....	88
6.4.	Starter Set HW v4.9.....	100
6.5.	Starter Set NIA-SmallDrone.....	110
6.6.	Starter Set Industrial-NIA-01.....	119
7.	Dashboard menu and Parameters.....	130
7.1.	Dashboard general view	130
7.2.	Diagnostics messages window.....	131
7.3.	Table of distances.....	134
7.4.	Devices List.....	136
7.5.	Visualization settings	137
7.6.	Map Settings	138
7.7.	Modem/beacon's quick control panel	139
7.8.	Celling and Mirroring buttons on the Dashboard	140
7.9.	Detailed settings	141
7.9.1.	Modem Settings.....	141
7.9.2.	Beacon's settings.....	147
7.10.	Radio frequency band and Carrier frequency.....	159
7.11.	Different hedgehog colors in the Dashboard	160
7.12.	Different beacons' colors in the Dashboard.....	161
8.	The Map.....	162
8.1.	Introduction	162
8.2.	Map layers	163
8.3.	The Submap	164
8.4.	Submaps' service zones.....	165
8.5.	Handover zones.....	166
8.6.	Beacons' ultrasonic frequencies	169
9.	Features	170

9.1. Licenses	170
9.1.1. How to activate licenses	170
9.1.2. License MMSW0005 designation in Dashboard	172
9.2. Islands feature	173
9.3. Dashboard Monitoring Mode	177
9.4. Microphone settings.....	178
9.4.1. Specific Marvelmind devices	178
9.4.2. Separate Omni-microphone.....	179
9.5. Restart if modem is disconnected.....	181
9.6. Geofencing zones	182
9.7. Geofencing alarm (MMSW0006 license)	185
9.8. PPS (Pulse per second) signal	188
9.9. Floors feature (FN0011)	189
9.9.1. The general view	189
9.9.2. Floor Settings.....	190
9.9.3. Map layers	192
9.10. Floorplan feature	193
9.10.1. Loading the Floorplan (Substrate)	193
9.10.2. Floorplan scaling.....	195
9.10.3. Move the floorplan on the Map	199
9.10.4. Other floorplan settings.....	200
9.11. All hedgehogs update every cycle	201
9.12. Filters	203
9.12.1. Spot filtering (for IA only)	203
9.12.2. Window of averaging (NIA only)	204
9.13. Submap Settings.....	205
9.14. Axis rotation feature (FN0002).....	206
9.15. Vertical submaps feature (FN0003).....	208
9.15.1. How to build vertical submap for stable Z:.....	209
9.16. Submaps feature (FN0004)	211
9.16.1. Starting submaps.....	212
9.16.2. How to create a service zone:	216
9.17. Handover Zones Setting	218
9.18. Paired beacons (FN0005).....	219
9.19. Paired microphones	224
9.20. Map settings.....	225
9.21. Background color	226
9.22. Hedge color change (FN0006)	228
9.23. Payload streaming (FN0007).....	230
9.24. IMU feature (FN0008).....	231
9.24.1. Setup IMU feature.....	231

9.24.2. Using Data in the Python Library Example.....	233
9.25. IMU axis positioning.....	234
9.26. Player feature (FN0009)	236
9.27. Real-time player feature (FN0010)	238
9.28. CSV format	240
10. Interfaces	241
10.1. Super-beacon external interface pinout top view	242
4x4 pinout for Super-Beacon:	242
10.2. Beacon HW v4.9 external interface 4x4 pinout top view	243
10.3. Modem HW v4.9 external interface pinout top view	244
10.4. Mini-RX internal solderable pinouts (for experienced users only)	245
11. Advanced system settings and optimization.....	246
11.1. Radio Profiles compatibility.....	247
Examples of different configurations	248
11.2. Wi-Fi settings for Super-Modem	249
11.2.1. Wi-Fi settings menu in Dashboard	249
11.2.2. Static IP.....	251
11.3. Building big maps in Inverse Architecture (IA).....	253
11.3.1. Introduction	253
11.3.2. TDMA sequence:.....	254
11.3.3. TDMA Type 2 - Full-overlapping submaps	256
11.4. Increasing update rate	259
11.5. Reducing location update latency	260
11.6. How to Place Beacons.....	262
11.7. Using the Oscilloscope	263
11.8. Proper Ultrasonic Signal Detection.....	264
11.9. Using hedgehog.log file	265
11.10. System Accuracy Evaluation	266
11.11. Calibration of the accelerometer.....	267
11.12. Settings to obtain correct north direction	269
11.13. Communication of Pixhawk with Marvelmind mobile beacon.....	270
11.14. Sending path to robot	271
11.15. Proper ultrasonic coverage.....	274
11.16. Sensors settings: example for 2D and mobile beacon	276
11.17. Powering beacons	277
11.18. Power supply and Leds	278
12. Frequently Asked Questions.....	279
13. Troubleshooting checklist	281
13.1. Checklist before starting the system:.....	282
14. Contacts	283

Version changes

V2023_03_28

- Sections 6.3, 6.4, 6.5, 6.6 updated. Turning on “Hedgehog mode” on beacon step added.

V2023_01_16

- Section 2.3 updated. New links added
- Chapter 9.10 Floorplan feature updated
- Minor improvements

V2022_12_25

- Chapter 2.2 Indoor Navigation System architectures updated

V2022_08_24

- Chapter 5.2.3 SW update via DFU updated
- Chapter 9.17 Paired beacons updated

V2022_08_24

- Chapter 6 updated
- Chapter 8 updated
- Section 11.3 updated
- Minor improvements

V2022_08_17

- Minor fixes and improvements

V2022_08_12

- Chapter 4 updated

V2022_08_10

- Section 9.11 Filters added
- Section 11.16 Sending path to robot updated
- Minor fixes and improvements

V2022_08_05

- Section 7.2 updated
- Section 9.12 added
- Section 9.2 Islands feature added
- Section 9.10 All hedgehogs update every cycle added
- Section 9.14.2 updated
- Chapter 10 updated
- Section 11.2.2 Static IP added

V2022_06_16

- Section 9.4 Restart if modem disconnected added
- Section 9.5 Geofencing alarm added
- Section 9.6 PPS (Pulse per second) signal added
- Section 11.1 Radio Profiles compatibility updated
- SW settings chapter moved to chapter 5
- Chapter 5.1.2 added

- Minor fixes and improvements

V2022_06_01

- Section 10.2 Wi-Fi settings for Super-Modem added

V2022_05_20

- Section 2.4 The Maps – moved to chapter 7
- Section 3.6.3.1 How to flash Beacon mini-RX added
- Section 8.22 updated
- Chapter 12 updated
- Section 4.4 updated
- Section 8.6 updated
- Section 10.1 Radio Profiles compatibility added

V2022_05_13

- Section 5.2 DIP switch position added
- Information about Industrial Beacons 3 added

V2022_05_06

- Section 7.11 updated
- Section 2.3 updated
- Section 9.1 updated

V2022_04_26

- Section 4 - Software pack added

V2022_04_07

- Section 4 screenshots updated
- Section 6.7.3 added
- Section 6.7.4 added
- Section 6.12 updated
- Section 6.13 updated
- Section 6.9.1 updated
- Section 5.9.2 updated

V2022_04_05

- 3.1 section updated
- 3.2 section updated
- 3.4 section updated
- 3.5.3 section updated
- Information about Starter Set NIA-01-3D removed
- Section 4.3 pictures of top view and side view changed to relevant
- Section 4 examples of 2D configuration added
- Information about Starter Set NIA-02-2D removed
- Information about Starter Set IA-01-2D removed
- Information about Starter Set IA-02-3D removed
- 5.1 section screenshot updated
- 5.4 section all screenshots updated

- 5.7 section screenshots updated
- 6.7.1 section updated
- 6.7.2 section screenshots updated
- Information about new frequencies added
- Section 11 updated
- Sections 3.6.4; 3.6.5; 3.6.6; 3.6.7 pinout picture from April 2022 added

V2022_02_23

- Screenshot and clarifications to section 7.2.2 added
- Unrelated information from section 9.11 removed
- Hyperlinks fixed
- Starter set product information updated
- 1.1 distance between beacons updated
- 3.2 section updated
- 3.4 section updated
- 9.11 section updated
- 11.1 section updated
- Minor fixes and improvements

V2021_08_12

- Omni-microphone soldering scheme added
- Omni-microphone setting description added

V2021_07_04

- Added Microphone settings chapter

V2021_06_20

- Added connection pictures for Paired beacons chapter
- Links fixed for interface manual

V2021_06_10

- "Paired microphones" chapter added.
- Turning on microphones setting describing added

V2021_06_04

- Super-Beacon 2 pinout picture updated

V2021_06_03

- Pairing beacon chapter and beacons pinout pictures updated

V2021_04_25

- Paired beacons chapter updated

V2021_02_09

- Minor fixes and improvements

V2021_01_28

- Architectures' elements chapter described
- Architectures chapter improved
- Minor fixes and improvements

V2020_12_21

- FCC notice for Super-Beacon description added
- Minor fixes and improvements

V2020_12_14

- FCC notice for Modem HW v5.1 description added
- Minor fixes and improvements

V2020_12_04

- Starting up chapters improved
- Minor fixes and improvements

V2020_12_01

- Starting up chapters improved
- Submap's settings chapter improved
- SW update chapter improved with DFU Programming descriptions
- Minor fixes and improvements

V2020_11_24

- Licenses chapter updated
- Different beacons' colors chapter improved
- Minor fixes and improvements

V2020_11_11

- Player chapter improved
- Diagnostics messages chapter described
- SW update chapter added
- Paired beacons chapter improved
- Minor fixes and improvements

V2020_08_07

- Modem HW v5.1 described
- Minor fixes and improvements

V2020_07_23

- System elements chapter improved
- Industrial beacons' transmitting/reception diagram described
- Minor fixes and improvements

V2020_07_15

- Mini-RX internal solderable pinouts
- Minor fixes and improvements

V2020_05_21

- Starting up Starter Set Super-MP-3D (1A) described
- Minor fixes and improvements

V2020_05_13

- Reducing update rate latency chapter improved
- Minor fixes and improvements

V2020_05_08

- Building big maps in Inverse Architecture (1A) chapter described
- Minor fixes and improvements

V2020_04_24

- Dashboard Monitoring Mode described
- Super-Modem described
- Super-Modem SW update described

- Minor fixes and improvements

V2020_04_09

- Minor fixes and improvements

V2020_04_07

- Background color described
- Height input in Starting up chapters described
- Minor fixes and improvements

V2020_02_27

- Geofencing zones described
- IMU axis positioning for Super-Beacon described
- External microphones soldering scheme for Super-Beacon improved

V2020_02_21

- Minor fixes and improvements

V2020_02_14

- Architectures comparison table added
- Legend chapter improved
- Minor fixes and improvements
- Floorplan Help video added

V2020_01_17

- External microphones connection for Mini-RX and Super-Beacon described
- Minor fixes and improvements

V2019_12_10

- Appendixes chapter improved
- Minor fixes and improvements

V2019_12_03

- Appendixes chapter added (protocols)
- Minor fixes and improvements

V2019_11_18

- Mini-RX solderable pinouts described
- Industrial connectors pinouts improved
- Minor fixes and improvements

V2019_10_31

- Industrial Super-Beacon Metal-25kHz described
- Starting up chapters for every starter set described
- Super-Beacon and Super-Beacon outdoor described
- Improved photos
- Reception diagrams for HW v4.9 improved
- Oscilloscope chapter improved
- Minor fixes and improvements

V2019_07_02

- Troubleshooting improved
- Architectures comparison improved
- Minor fixes and improvements

V2019_06_25

- TDMA modes described
- Stationary beacons' colors described

- Minor fixes and improvements

V2019_06_13

- Delay tuning described
- Update rate tuning described
- Minor fixes and improvements

V2019_06_07

- F.A.Q. and Troubleshooting improved
- Architectures comparison improved
- Receiving and transmitting angles illustrations added (v4.9 chapter and Mini-RX chapter)
- Ceiling and mirroring buttons described

V2019_06_03

- TDMA described

V2019_05_28

- IMU axis positioning fixed
- IA details added
- Troubleshooting improvements
- Minor fixes and improvements

V2019_05_16

- Introduction of the Legend
- Added missing video on page 34
- Minor fixes and improvements

V2019_04_30

- DFU programming described
- Magnetic reset for Industrial beacons and DFU programming described
- Minor fixes

V2019_04_04

- Starting up the system description for different Starter Sets (NIA, Industrial NIA and IA)
- Sending path to robot described

V2019_03_18

- New names for beacons: DSP => Mini-RX, Mini-beacon => Mini-TX, Beacon-TX-25-IMU-IP67-RS485 => Industrial-TX, Beacon-RX-IMU-IP67-RS485 => Industrial-RX
- Starting up the system description for different Starter Sets

V2019_02_05

- Licenses described
- Minor fixes and improvements

V2019_01_29

- Mini-RX Inverse SW flashing described
- Added new types of beacons
- Minor fixes and improvements

V2019_01_12

- Mini-RX beacon and Mini-TX described
- IMU axis described
- Minor fixes and improvements

V2018_12_02

- Major new feature – support for 250 beacons (mobile + stationary combined) and 250 submaps per modem

- New feature: user must setup handover zones between submaps to guarantee handover quality for complex maps with multi-floor and similar
- New feature: default wireless connection is setting is now 153kbps (used to be 38kbps). Radio profile 153kbps provides radio coverage range nearly as much as 38kbps and update rate nearly as high 500kbps, i.e. it is a middle of 38kbps and 500kbps, combining the best of both
- Correction: USB streaming in power save mode improved
- Correction: Zero IMU button in the Dashboard is improved, while button Reset IMU is removed completely
- Correction: ultrasound TX is not reset to 31kHz when Default button is pressed. Now, several types of ultrasonic frequencies supported, so 31kHz is not anymore default ultrasonic frequency for all beacons
- Improved: both energy saving and tracking quality with Power Saving mode enabled
- Improved: only beacons with selected tick in the Dashboard lower menu will be accepted to the network – not any addresses. This improves predictability of the network, when there many beacons that may not belong to the network. Their attempts to join the network will be blocked
- Improved: now, submaps support up to 4 beacons only. More than that – build another submap. Up to 250 beacons (mobile + stationary combined) and up to 250 submaps are supported per beacon
- Bug fix: improved map building with active hedgehog
- Bug fix: duplicated address might work incorrectly in some cases

V2018_11_08

- Real-time player feature described

V2018_08_30

- New SW features described
- New Dashboard view described

V2018_08_03

- Calibration of accelerometer described
- F.A.Q. updated
- Troubleshooting guide described
- Refreshed links
- Player feature described
- IMU feature described
- Minor fixes

1. Executive summary

Marvelmind Indoor Navigation System is an off-the-shelf indoor navigation system, designed to provide precise ($\pm 2\text{cm}$) location data to autonomous robots, vehicles (AGV), and copters. It can also be used to track moving objects via mobile beacons attached to them. Other applications include, for example, forklifts, virtual reality (VR) systems, helmets for construction workers or miners, etc.

The navigation system consists of a network of stationary ultrasonic beacons interconnected via radio interface in a license-free band, one or more mobile beacons installed on objects to be tracked and modem providing gateway to the system from PC or other computers.

Mobile beacon's location is calculated based on a propagation delay of an ultrasonic pulses (Time-Of-Flight or TOF) between stationary and mobile beacons using trilateration algorithm.

The system can build the map of stationary beacons automatically. In simple cases, no additional manual data input or any manual distance measurements are required. This map formed once can be frozen and stored in modem's memory and the system becomes fully active within 7 to 10 seconds after the modem is powered.



Fig. 1: Example of Starter Set based on Super-Beacons

Minimum configuration requirements to ensure optimal performance of the Marvelmind Indoor Navigation System:

- For 3D (X, Y, Z) tracking: an unobstructed line of sight (hearing) between a mobile beacon and 3 or more stationary beacons within 30 meters
- For 2D (X, Y) tracking - an unobstructed line of sight (hearing) between a mobile beacon and 2 or more stationary beacons within 30 meters

1.1. Key capabilities:

Parameter	Technical Specifications
Distance between beacons	<ul style="list-style-type: none"> - Reaches up to 50 meters and up to 100 meters with horn under laboratory conditions (Mini-RX or Super-Beacon to Super-Beacon with RX4 only) - Recommended distance is 30 meters (Transducer4 on the first beacon is looking straight at the Transducer4 on the second beacon, other transducers are switched off)
Coverage area	<ul style="list-style-type: none"> - Reaches up to 1000m² with the Starter Set configurations - Coverage for larger territories is provided using submap – like cells in cellular networks
Location precision	<ul style="list-style-type: none"> - Absolute: 1–3% of the distance to the beacons - Differential precision: ±2cm
Location update rate	<ul style="list-style-type: none"> - 1/20Hz to 25Hz (Ultrasonic based only) - 100Hz with ultrasonic + IMU fusion enabled (Only for Beacons HW v4.9-IMU-Discontinued) - Can be set manually via Dashboard software - Depends on the distance between mobile and stationary beacons (shorter distance—higher update rate) - Depends on the number of mobile beacons (Non-Inverse Architecture; for Inverse Architecture no such dependency) - Depends on the radio profile (500kbps, 153kbps, 38kbps) - Slightly depends on the number of stationary beacons—dependence is not the same as for mobile beacons
Power supply	Internal: 1000mAh LiPo battery (Super-Beacon) <ul style="list-style-type: none"> - Battery lifetime: from 2 days to several months depending on the mode of operations *For other types of beacons look to the comparison table
	External: micro USB – recommended for permanent use
Weight	Mobile beacon (Super-Beacon) from the starter set: <ul style="list-style-type: none"> - 59 grams (including 1000mAh battery, Super-Beacon housing and 50mm antenna) - 27 grams (Super-Beacon, bare board w/o battery) *For other types of beacons look to the comparison table
Beacon size	Size: 55x55x33mm (with 50mm antenna: 55x55x65mm) (Super-Beacon) *For other types of beacons look to the comparison table

1.2. Legend

Legend chapter contains small icons and signs to highlight some key points of the text.



- Important



- For experienced users



- Demo or Help video



- Useful link

2. Basics of the system

Here are examples of the Starter Sets:

2.1. What's in the box

2.1.1. Starter Set Super-MP-3D:

- 4 x Stationary [Super-Beacons](#) with different frequencies (19kHz, 22kHz, 25kHz, 28kHz, 31kHz, 34kHz, 37kHz, 45kHz). Can be used as AI and NIA.
- 1 x Mobile [Super-Beacon](#)
- 1 x [Modem v5.1](#) supporting up to 250 beacons



2.1.2. [Starter Set IA-04-2D-Badge:](#)

- 2 x [Super-Beacons](#) – 915/868 MHz with different ultrasonic frequencies (f1 and f2 – usually, 25kHz and 31kHz).
- 1 x [Marvelmind Badge](#) – 915/868 MHz as mobile beacon
- 1 x [Modem HW v5.1](#) – 915/868 MHz as central controller of the system



*This is just an example of two starter sets.
You can see more options on our website: [Products](#)

2.2. Indoor Navigation System architectures

Marvelmind Indoor Navigation System provides high-precision ($\pm 2\text{cm}$) indoor coordinates for autonomous robots and systems ("indoor GPS"). A brief description of the key elements of the system is given on the scheme below.



IA and NIA SW differs

For IA you should use stationary beacons with different frequencies

Below you can see 3 types of architectures: Non-Inverse (NIA), Inverse (IA) and Multi-frequency NIA (MF NIA):

2.2.1. Inverse Architecture

For IA you should use stationary beacons with different frequencies

Inverse Architecture (IA)

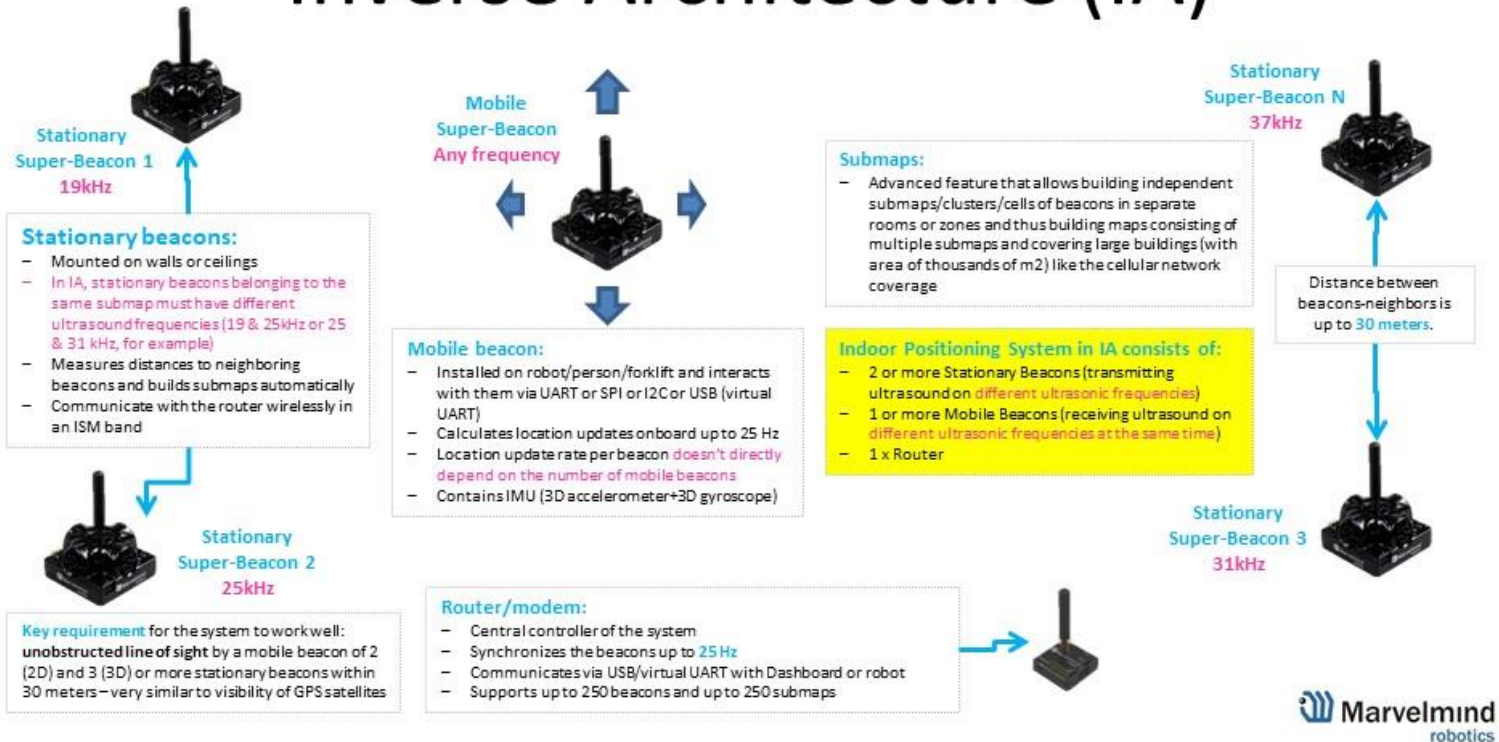

Non-Inverse Architecture (NIA)

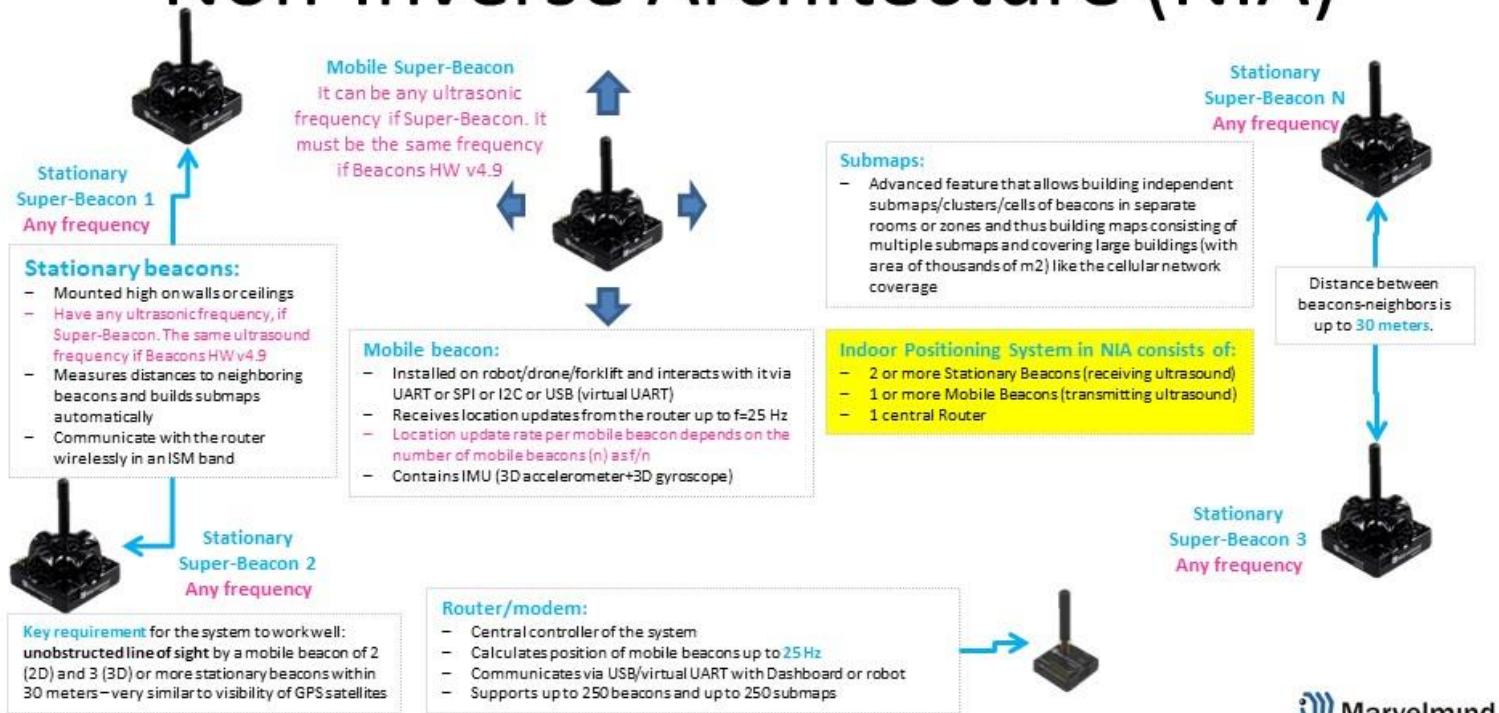

2.2.3. Multi-Frequency NIA (MF NIA)

license • [MMSW0004: MF NIA support](#) is needed to use MF NIA

Multi-Frequency NIA (MF NIA)

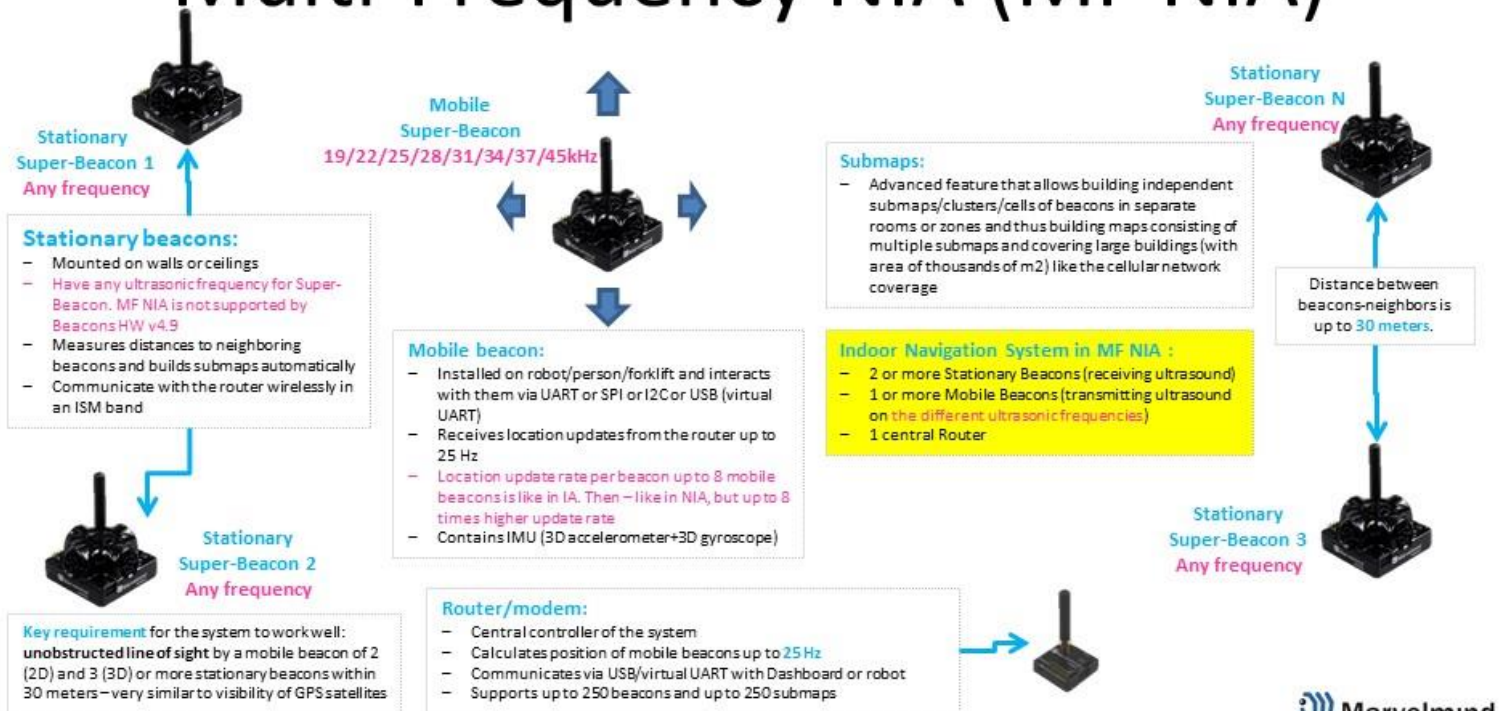

2.2.4. Architectures comparison table

Architectures comparison

	Non-Inverse (NIA)	Inverse (IA)	Multi-Frequency NIA (MF NIA)
Typical usage	<ul style="list-style-type: none"> - 1-4 autonomous robots/drones - supports up to 250 beacons (stationary+mobile) - When mobile beacon shall be installed on a noisy drone/vehicle, but stationary beacons are in relatively quieter places 	<ul style="list-style-type: none"> - Many mobile users (people, robots, VR) and when update rate per mobile is important - supports up to 250 beacons (stationary+mobile combined) - When mobile beacons are in quieter places 	<ul style="list-style-type: none"> - 5-16 autonomous robots/drones - supports up to 250 beacons (stationary+mobile combined) - Effectively, MF NIA combines the best from both IA and NIA. But it is still "more NIA than IA", because the mobile beacons are emitting the ultrasound
Not recommended	<ul style="list-style-type: none"> - In applications, where emitting ultrasound of mobile beacon is undesirable 	<ul style="list-style-type: none"> - For drones – because mobile beacons are receiving ultrasound. The range may be limited to just 2-5m. May be improved with future SW releases 	<ul style="list-style-type: none"> - In applications, where emitting ultrasound of mobile beacon is undesirable
Accuracy	<ul style="list-style-type: none"> - $\pm 2\text{cm}$ or better with more averaging 	<ul style="list-style-type: none"> - $\pm 2\text{cm}$ or better with more averaging 	<ul style="list-style-type: none"> - $\pm 2\text{cm}$ or better with more averaging
Update rate	<ul style="list-style-type: none"> - Depends on the number of mobile beacons (n) as f/n –TDMA is used - Slightly depends on the radio profile - Depends on the sizes of submaps - IMU fusion is HW and SW supported 	<ul style="list-style-type: none"> - Does not depend on the number of mobile beacons, because they are receiving ultrasound at the same time - Slightly depends on the radio profile (the same as NIA) - Depends on the sizes of submaps (the same as NIA) - IMU fusion is HW supported. SW support is coming 	<ul style="list-style-type: none"> - Depends on the number of mobile beacons (n) for $n > 8$ –TDMA is used, i.e. can provide up to 8 times higher update rate than NIA with the same number of mobiles. Up to 8 mobiles the update rate per mobile is equal to IA - The rest – like NIA
Range	<ul style="list-style-type: none"> - Can cover as large territory as you wish using submaps - Up to 30m in real life and up to 50m in lab conditions within a single submap, i.e. stationary beacons shall be placed every 30m or closer (in 1D with horns – up to 120m) 		
Map building	<ul style="list-style-type: none"> - Can build submaps automatically and manually 	<ul style="list-style-type: none"> - Can build submaps automatically and manually 	<ul style="list-style-type: none"> - Can build submaps automatically and manually

Version 2022_08_21



Here is tutorial video about architectures:

[Help: Inverse Architectures \(IA\) vs. Non-Inverse Architectures \(NIA\)](#)

[NIA vs. IA vs. MF NIA - how to choose?](#)

2.3. Architectures' elements

A **map** is a system unit that includes **submaps**, **stationary beacons** and **service zones** within which positioning of **mobile beacons** is ensured by ultrasonic signals from the **stationary beacons** of this submap.

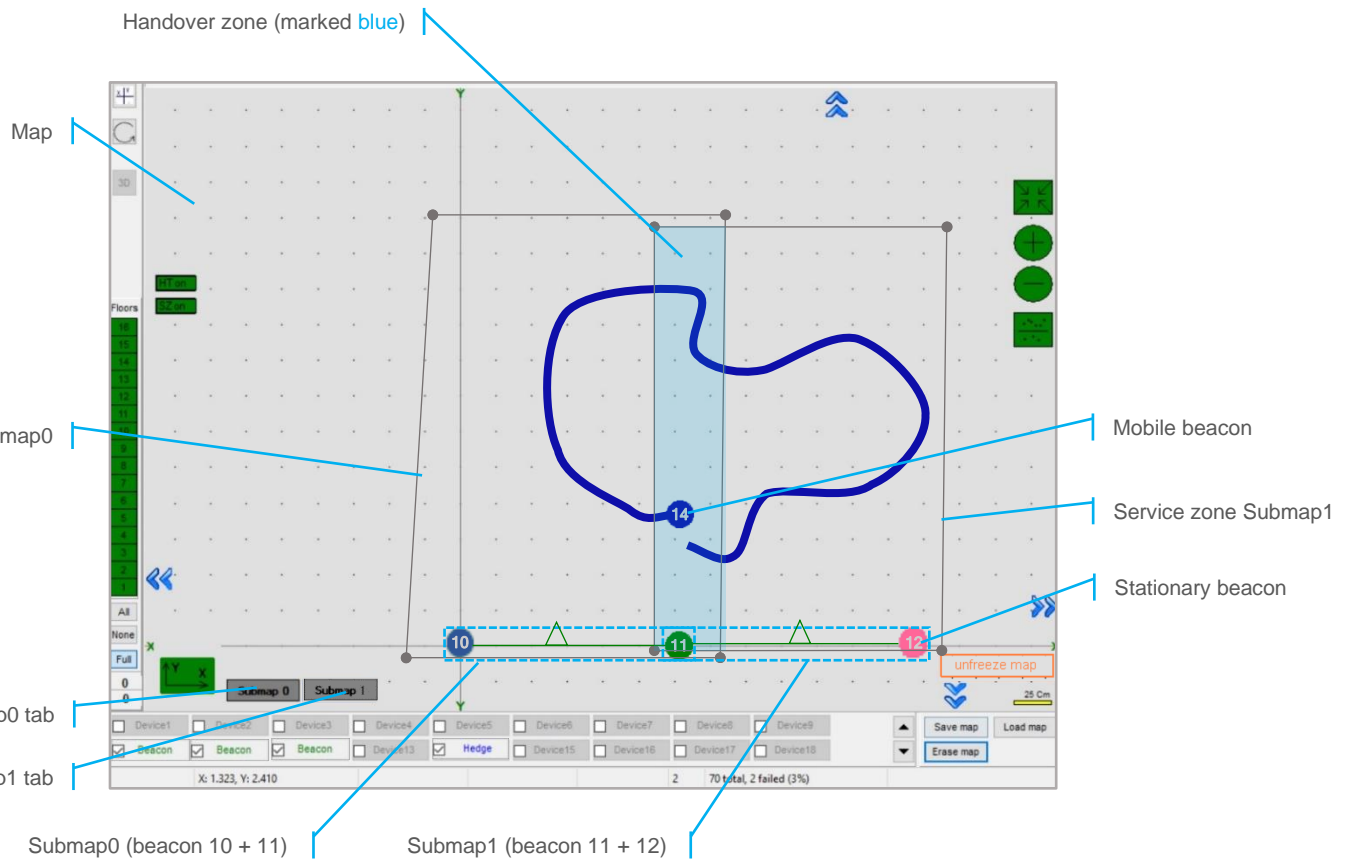

The main parameters of a submap are its **size**, **frequencies** and **TDMA position** of stationary beacons, by which mobile beacons can not only be positioned, but also determine in which submap the mobile beacon is located.

Here is the main tutorial video about maps:

- [Help: submaps, service zones, handover zones](#)

Detailed explanation of complex map building:

- [Building submaps: Part 1](#)
- [Building submaps: Part 2](#)

2.4. Indoor “GPS” System close-up and internal view

Here, you can see how system elements look like

- [Super-Beacon:](#)



- [Modem HW v5.1:](#)



- [Beacon Mini-RX:](#)



- [Beacon Mini-TX:](#)



- [Beacon Industrial-RX:](#)



- [Beacon Industrial-TX-Metal:](#)



- [Industrial Super-Beacon-Plastic:](#)



3. System elements

Here are represented core elements required for stable working of the system:

3.1. Control system (Dashboard)

Dashboard is a Windows/Linux app for setting up and tuning the system. It also allows to get the tracking data.

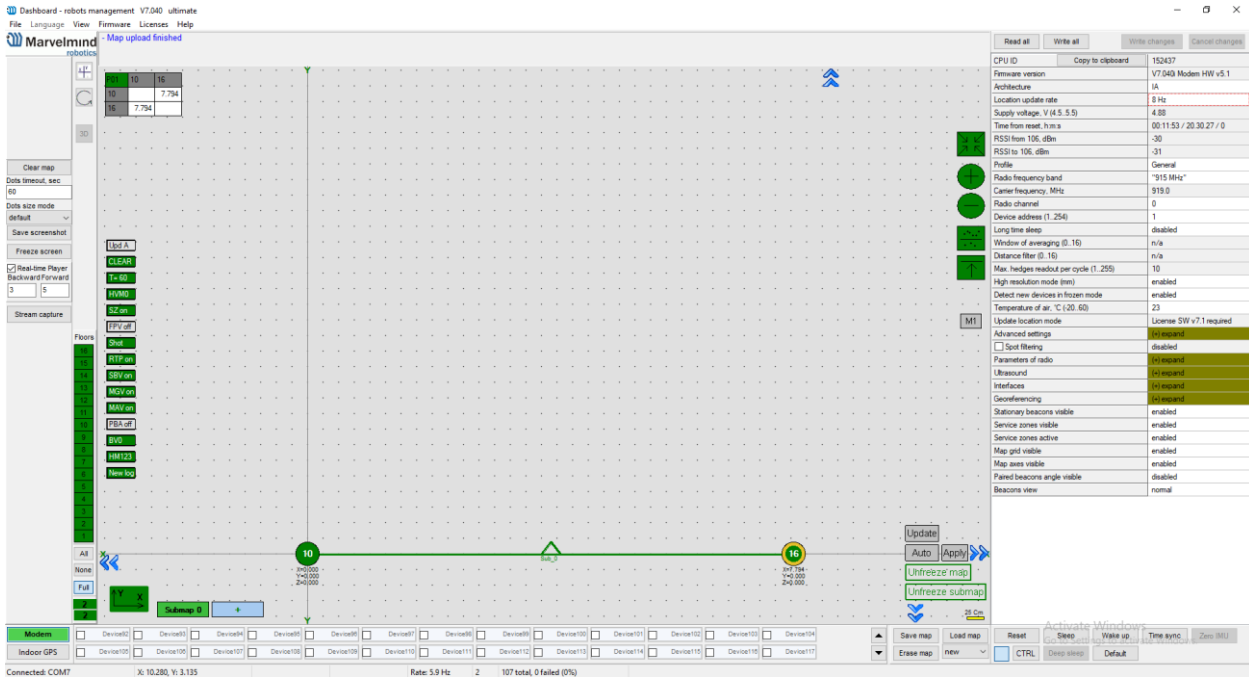

- General app for SW update and initial setting up the system
- Contains a lot of tracking display features
- Very deep tuning and setting abilities
- All new features available in the Dashboard app



You can get data without the Dashboard, the whole system after setting up can work without it

3.2. Stationary beacon

- Usually mounted on walls or ceilings above the robot with ultrasonic sensors facing down—to provide the most robust unobstructed ultrasonic signal coverage to the robot. However, for automatic landing and indoor navigation of copters, for example, it is recommended to install mobile beacon horizontally on the belly of the copter so that the beacon would be looking downwards
- The position and orientation of the beacons should be chosen in a way that provides maximum ultrasonic signal coverage. System efficacy strongly depends on the quality of ultrasonic signal received by stationary beacons
- Stationary beacons emit and receive ultrasound during the map configuration period. In non-inverse architecture once the map is formed and frozen, they only work as receivers. In inverse architecture they only work as transmitters.
- Stationary beacons have no exterior differences with regard to mobile beacons
- The mobile and stationary beacons can be easily interchanged during configuration in the Dashboard
- There are 433MHz(out of production, get bug-fixing SW update only) and 868/915MHz versions available. A proprietary radio protocol is used for communication and synchronization. Other ISM bands are available upon request as well
- Stationary beacon can be equipped with full-size 165mm antenna , which provides more robust radio connection between modem and beacons.



Fig. 1: Super-Beacon as an example

3.3. Mobile beacon a.k.a. “hedgehog”

- The mobile and stationary beacons can be easily interchanged by selecting in the Dashboard
- The mobile beacons designed to be placed on a robotic vehicle, copter/drone, AGV, or helmet to trace its location. Formally speaking, location of the mobile beacon is traced—not the robot itself. Since the sizes and the location of the central point of the mobile beacon and the robot are different, the difference taken into account in the robot’s software (SW)
- It is recommended to place the mobile beacon horizontally to provide optimal ultrasonic coverage in the upper hemisphere
- Its sensors must not be covered with anything that can reduce the strength of ultrasonic signal. For example, the system won’t normally work, if one puts the mobile beacon in a plastic box
- The beacon’s coordinates are updated according to the rate set on the Dashboard
- The system may contain one or several mobile beacons. Current implementation relies on a time-division multiple access approach. Thus, if two mobile beacons are activated, they share the same system bandwidth. It means that, if the 16 Hz update rate is selected in the Dashboard and there are 2 mobile beacons in the system, each beacon’s location will be updated with the rate of $16\text{Hz}/2 \sim 8\text{Hz}$. If there are 3 mobile beacons $\Rightarrow 16\text{Hz}/3 \sim 5\text{Hz}$, etc. For 4 and more mobile beacons we recommend using Inverse Architecture. See more in [Architectures comparison](#)
- Location data is obtained either from the “hedgehog” via USB (virtual UART), UART, SPI, or from the modem/router via USB (virtual UART). More information on interfaces can be found [here](#) (Mini-TX Beacons do not have pinouts, only over mirco USB)
- Data from the beacon sent in a streaming format identical to that of GPS (NMEA 0183)
- There are 433MHz(out of production, get bug-fixing SW update only) and 868/915MHz versions available. Proprietary radio protocol is used for communication and synchronization
- The “hedgehog” has been successfully integrated with Windows PC, Linux machines, Raspberry Pi, Arduino boards, Intel boards, etc.



Fig.1: Super-Beacon as an example



3.4. Modem

- Modem is the central controller of the system. It must always be powered when the Navigation System is working. It is recommended to use an active USB hub for that purpose or even a regular cellular phone USB power supply. A USB power bank can also be used
- The modem is also used to set up the system, monitor it, and interact with the Dashboard
- It can be placed anywhere within radio coverage for permanent radio connection with all beacons—usually in the radius of up to 100 meters with antennas from the Starter Set
- Radio coverage further extended to a few hundred meters by using a lower bitrate of 38kbps and full-size (165mm for a 433 and 915MHz band) antennas, which have been tested to provide up to 400m in ideal conditions
- There are 433MHz (only for HW v4.9, out of production, get bug-fixing SW update only) and 915MHz versions available
- A proprietary radio protocol used for communication and synchronization between modem and beacons



Fig. 1: HW v5.1 Modem as an example

3.5. Different types of modems

There are 3 types of Marvelmind modems:

- [Modem HW v5.1](#) – newest and mostly use version of modem.
- [Modem HW v 4.9](#) – old version of Modem HW v5.1. out of production, get bug-fixing SW update only
- [Super-Modem](#) - is a superior version of the Modem HW v4.9 and Modem HW v5.1 with advanced capabilities

3.5.1. Super-Modem

Super-Modem is a superior version of the Modem HW v4.9 and Modem HW v5.1 with advanced capabilities.

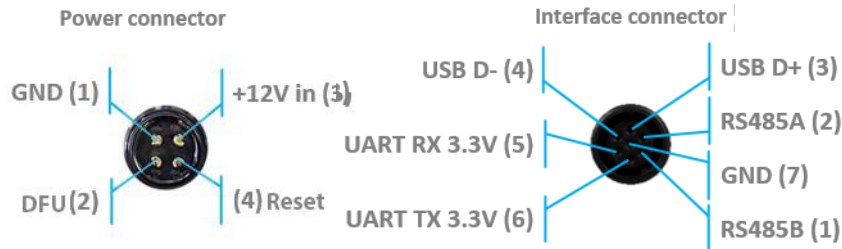

Fig.2: Super-Modem's contents of delivery

- Super-modem supports all the basic features of HW v4.9 Modem and can be connected over USB to the Dashboard for system tuning and control (Do not forget to power Super-Modem via Power connector)
- UDP streaming over Wi-Fi is supported. In the future remote control of the modem and the whole system via TCP-IP will be supported too
- Bluetooth (HW enabled, but not yet supported in SW)
- >1000x more RAM and >1000x Flash memory than Modem HW v4.9
- Full-size bendable antenna by default
- Higher ingress protection - up to IP67 (optional)
- Super-Modem's HW supports Super-Modem and Super-Super-Modem functionality for Multi-Modem architecture: https://marvelmind.com/pics/marvelmind_presentation.pdf
- Designed for outdoor and industrial applications
- External bendable antennas with SMA connector for extended radio range included



- Currently, supports license-free 915MHz ISM band (for example, US, Japan, Korea) and license-free SRD band 868MHz (EU, Russia). Future 433MHz HW variants may come in some months, but no firm schedule yet. You can place orders for 433MHz. When sufficient amount is collected, we will produce the 433MHz version as well
- Supports all types of beacons working in the 915MHz band (among them: Super-Beacons, all Industrial beacons, Mini-RX, Beacons HW v4.9, Helmets, Badges, Jackets, Watches, etc.)
- Two IP67 external connectors included (similar to Industrial beacons):



- Exactly the same mounting holes as for Industrial beacons
- No battery inside – external power supply (+6..17V) required (for example, <https://marvelmind.com/product/converter-220v-12v-ip67/>). External battery is not practical for long-term due to relatively high and constant power consumption of 1.5-2W
- For optional IP67 version – extended working temperature range: -40C...+50C (provided by design – not tested, not certified)
- Embedded reset switch and DFU switch – magnetic control or external pins on IP67
- Supports both IA and NIA. Can be easily switched between the modes in the Dashboard
- Radio range to beacons – up to a few hundred meters in the open space area. Wi-Fi – a few tens of meters in the open space



3.5.2. Modem HW v5.1

[Modem HW v5.1](#) is a superior version of the Modem HW v4.9.



Modem HW v5.1 looks almost the same as Modem HW v4.9. To distinguish it, check white sticker on the bottom

Modem HW v5.1 and Modem HW v4.9 brief comparison:

- Modem HW v5.1 has more memory
- Modem HW v5.1 has higher radio range
- Modem HW v5.1 more sensitive
- Modem HW v5.1 has TELEC T-108 Japan certification
- All new features come to the new Modem HW v5.1
-



Fig.1: Modem HW v5.1



Fig.2: Bottom sticker

- FCC NOTICE:

This equipment has been tested and found to comply with the limits for a Class B digital device, pursuant to Part 15 of the FCC Rules. These limits are designed to provide reasonable protection against harmful interference in a residential installation. This equipment generates, uses and can radiate radio frequency energy and, if not installed and used in accordance with the instructions, may cause harmful interference to radio communications. However, there is no guarantee that interference will not occur in a particular installation. If this equipment does cause harmful interference to radio or television reception, which can be determined by turning the equipment off and on, the user is encouraged to try to correct the interference by one or more of the following measures:

Reorient or relocate the receiving antenna

Increase the separation between the equipment and receiver

Connect the equipment into an outlet on a circuit different from that to which the receiver is connected

Consult the dealer or an experienced radio/TV technician for help

Changes or modifications not expressly approved by the party responsible for compliance could void the user's authority to operate the equipment.

This device complies with part 15 of the FCC Rules. Operation is subject to the following two conditions:

- (1) This device may not cause harmful interference, and
- (2) This device must accept any interference received, including interference that may cause undesired operation.

The equipment should be installed and operated with minimum distance 20cm between the radiator & your body.

3.5.3. Modem HW v4.9

[Modem HW v4.9](#) has balanced features and performance.



Since Modem HW v5.1 released, Modem HW v4.9 will get bug-fixing SW updates only

- The modem is also used to set up the system, monitor it, and interact with the Dashboard
- It can be placed anywhere within radio coverage for permanent radio connection with all beacons—usually in the radius of up to 100 meters with antennas from the Starter Set
- Radio coverage further extended to a few hundred meters by using a lower bitrate of 38kbps and full-size (165mm for a 433MHz band) antennas, which have been tested to provide up to 400m in ideal conditions
- There are 433MHz and 915MHz versions available
- A proprietary radio protocol used for communication and synchronization between modem and beacons



Fig. 1: Modem HW v4.9

3.6. Different types of beacons

There are many types of beacons. Each of them is using in different ways, depends on your case and preferences.

There is small Beacon Mini-RX that can receive ultrasound and mostly using as mobile beacon.

Compact beacon Mini-TX – for ultrasound transmitting only. This is good for copter and tracking for its small size.

Super-Beacon – can receive and transmit ultrasound, using in most cases. Could be made in Outdoor modification.

Industrial Beacons – suitable for huge manufacturing and outdoor installations.

Here you can see more details about the different types of beacons:

https://marvelmind.com/pics/marvelmind_beacons_comparison.pdf



3.6.1. Super-Beacon

The Super-Beacon is a dual-use beacon – it can both receive and transmit ultrasonic pulses.

The Super-Beacon Beacon can be used in both the Non-Inverse Architecture (NIA) and the Inverse Architecture (IA): [Architecture comparison](#).

Supports license-free 915MHz ISM band (US) and license-free SRD band 868MHz (EU). Support of the 433MHz ISM band (EU) comes with a larger order.

Key features:

- The Super-Beacon has a separate receiving part with a single wide-beam microphone and sharp DSP filters (like Mini-RX or Industrial-RX has). Thus, it is more sensitive, than Beacon HW v4.9, more resistant to external noise, and easier to setup, because you don't have to care about turning on and off ultrasonic sensors in order to optimize coverage vs. sensitivity
- The Super-Beacon can receive any ultrasonic frequency from the bands: 19kHz, 22kHz, 25kHz, 28kHz, 31kHz, 34kHz, 37kHz, 45kHz. The filter can be simply selected in the Dashboard. At the same time, the ultrasonic frequency of Beacon HW v4.9 is HW-defined by ultrasonic sensors and can't be changed
- The Super-Beacon can receive several ultrasonic frequencies at once. That is used in the Inverse Architecture. See the [comparison](#)
- The Super-Beacon has several-times improved battery lifetime in TX mode as compared with Beacon HW v4.9
- The Super-Beacon can work with regular Beacons HW v4.9 and Mini-RX and Industrial-RX in any combination as a part of a Starter Set or as a part of navigation systems. In all cases, beacons shall use the same radio band

[Super-Beacon also has outdoor \(IP54\) version](#), which is protected from dust and water

Demo video: [Demo: IP56 testing of Super-Beacon-IPxx](#)



Figure 1: Outdoor version (IP54)

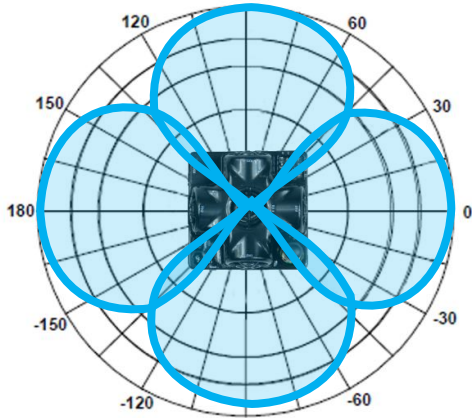

Figure 2: Transmitting diagram (with ultrasound transmitters)

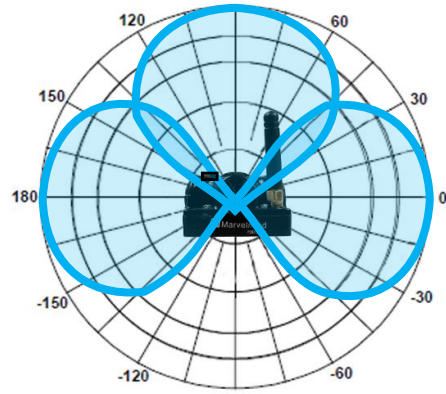

Figure 3: Transmitting diagram (with ultrasound transmitters)

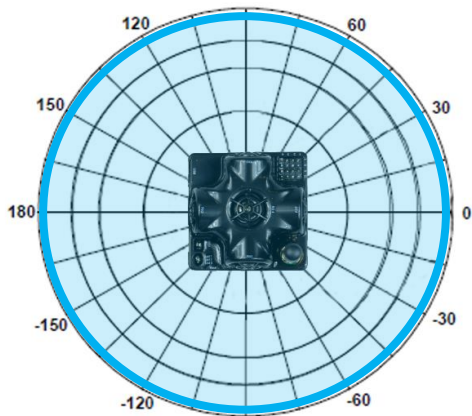

Figure 4: Receiving diagram (with digital microphone)

FCC NOTICE:

This equipment has been tested and found to comply with the limits for a Class B digital device, pursuant to Part 15 of the FCC Rules. These limits are designed to provide reasonable protection against harmful interference in a residential installation. This equipment generates, uses and can radiate radio frequency energy and, if not installed and used in accordance with the instructions, may cause harmful interference to radio communications. However, there is no guarantee that interference will not occur in a particular installation. If this equipment does cause harmful interference to radio or television reception, which can be determined by turning the equipment off and on, the user is encouraged to try to correct the interference by one or more of the following measures:

- Reorient or relocate the receiving antenna
- Increase the separation between the equipment and receiver
- Connect the equipment into an outlet on a circuit different from that to which the receiver is connected
- Consult the dealer or an experienced radio/TV technician for help

Changes or modifications not expressly approved by the party responsible for compliance could void the user's authority to operate the equipment.

This device complies with part 15 of the FCC Rules. Operation is subject to the following two conditions:

- (1) This device may not cause harmful interference, and
- (2) This device must accept any interference received, including interference that may cause undesired operation.

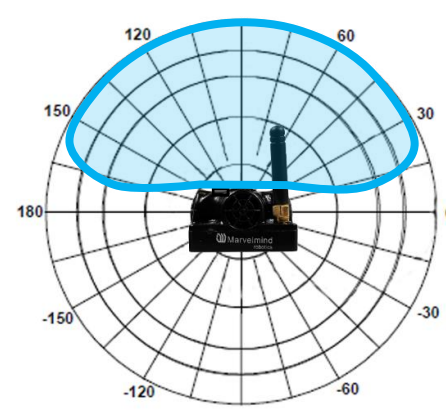

Figure 5: Receiving diagram (with digital microphone)

The equipment should be installed and operated with minimum distance 20cm between the radiator & your body.

3.6.1.1. Omni and External microphones extension

This modification of the Super-Beacon allows you to bring the receiving microphone to any place on your robot or clothing. Due to this, the microphone body itself will not interfere, and will not be visible. It allows you to create more accurate implantation.

It is possible to connect [External Microphone-IP67](#) or [Omni-Microphone-IP67](#)

It is also possible to use 2 External Microphones to calculate the direction, or to improve and increase the reception area.

Omni-Microphone-IP67 wire length is 1m, it connects to 4x4 pinout in default configuration.

External microphone length is 25cm (default), may be expanded up to 1m (optional). Check out the [product page](#).



Be careful: You should have soldering skills to solder External Microphone on board



Figure 1: Super-Beacon with one External Microphone connected



Figure 2: Super-Beacon with two External Microphones connected



Figure 3: Super-Beacon with Omni

3.6.1.2. Omni microphone schemes



If you don't want to use 4x4 pinout to connect Omni, use this scheme to solder it.

Be careful: You should have soldering skills to solder Omni Microphone on board

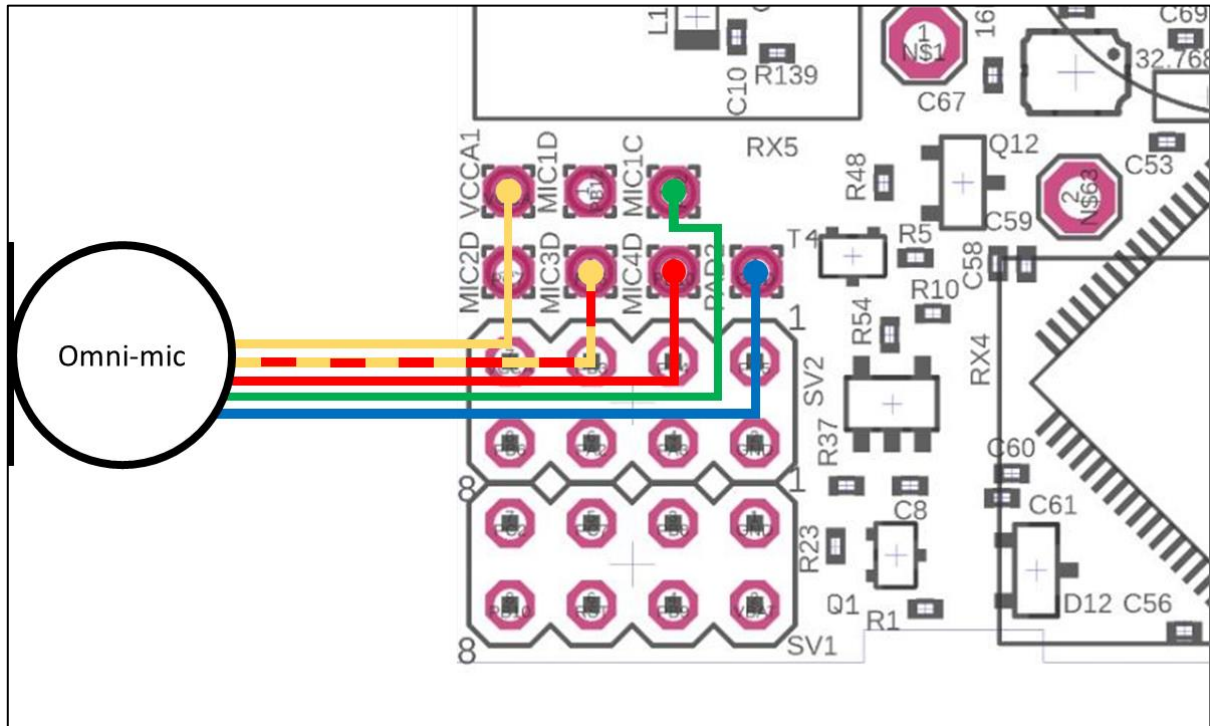

Figure 4: Omni-Microphone connection for Super-Beacon

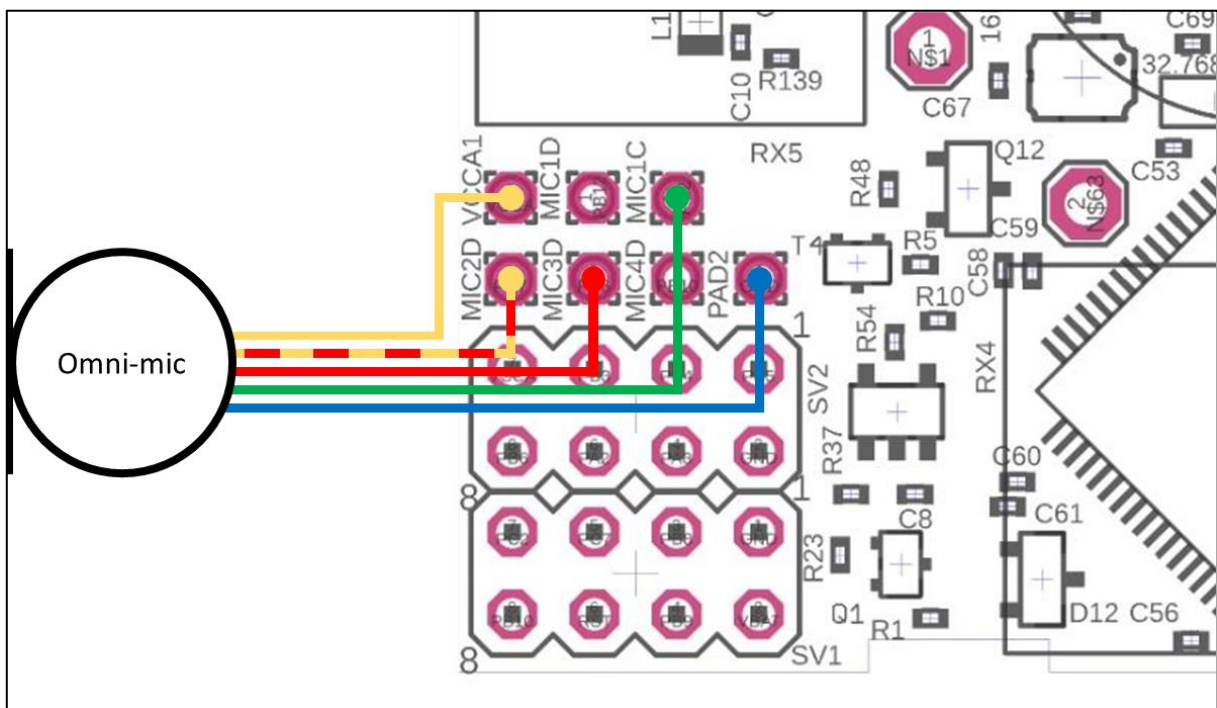

Figure 5: Omni-Microphone connection for Super-Beacon-2 and Super-Beacon-3

3.6.1.3. External microphones schemes:



There can be some beacons (from one of the batches) with mixed default microphone wires' colors

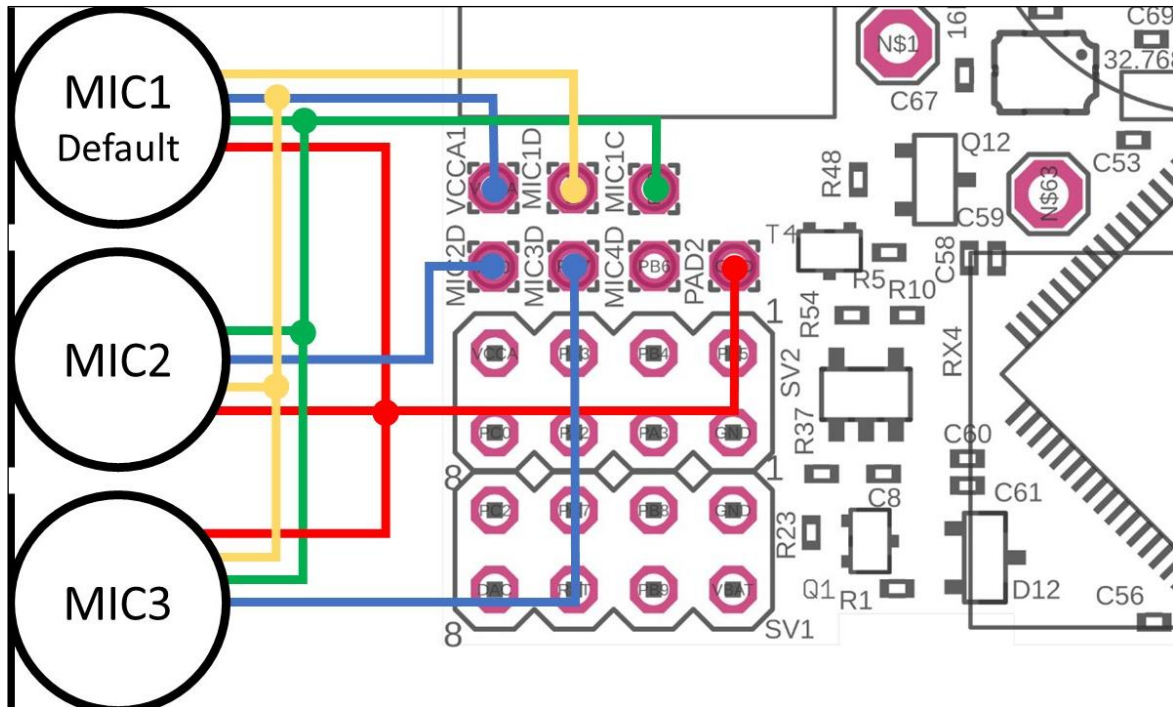

Figure 6: Connection for beacon with switched blue and yellow wires

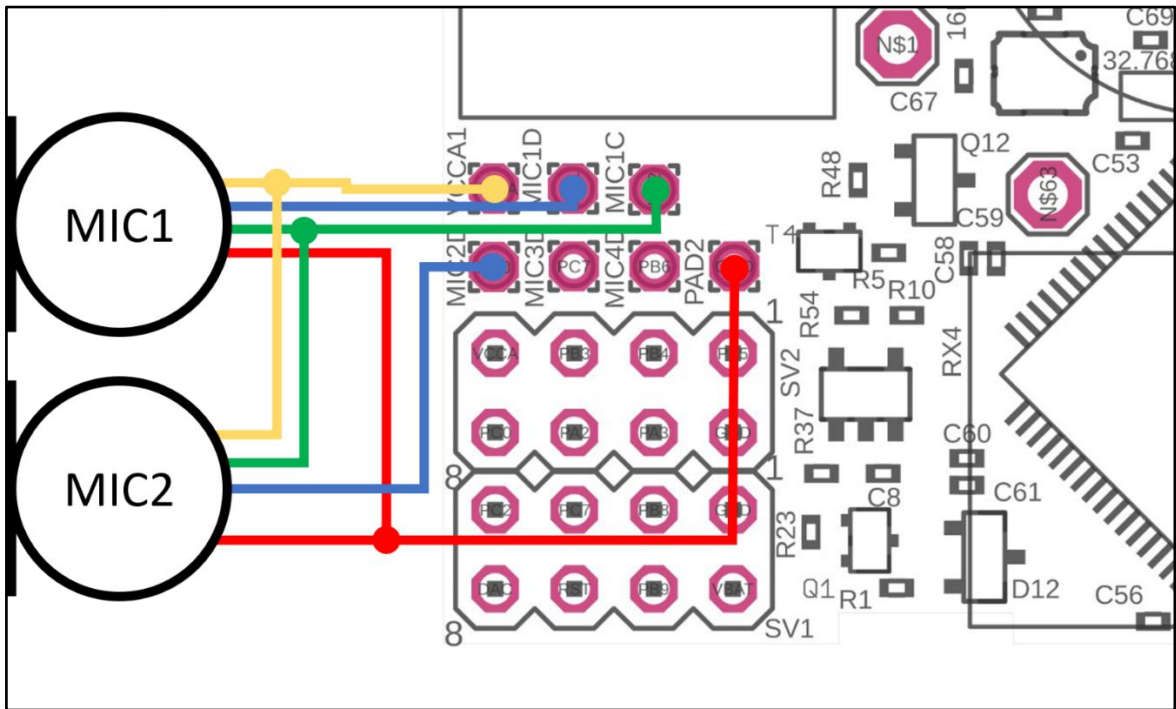

Figure 7: One External Microphone connection

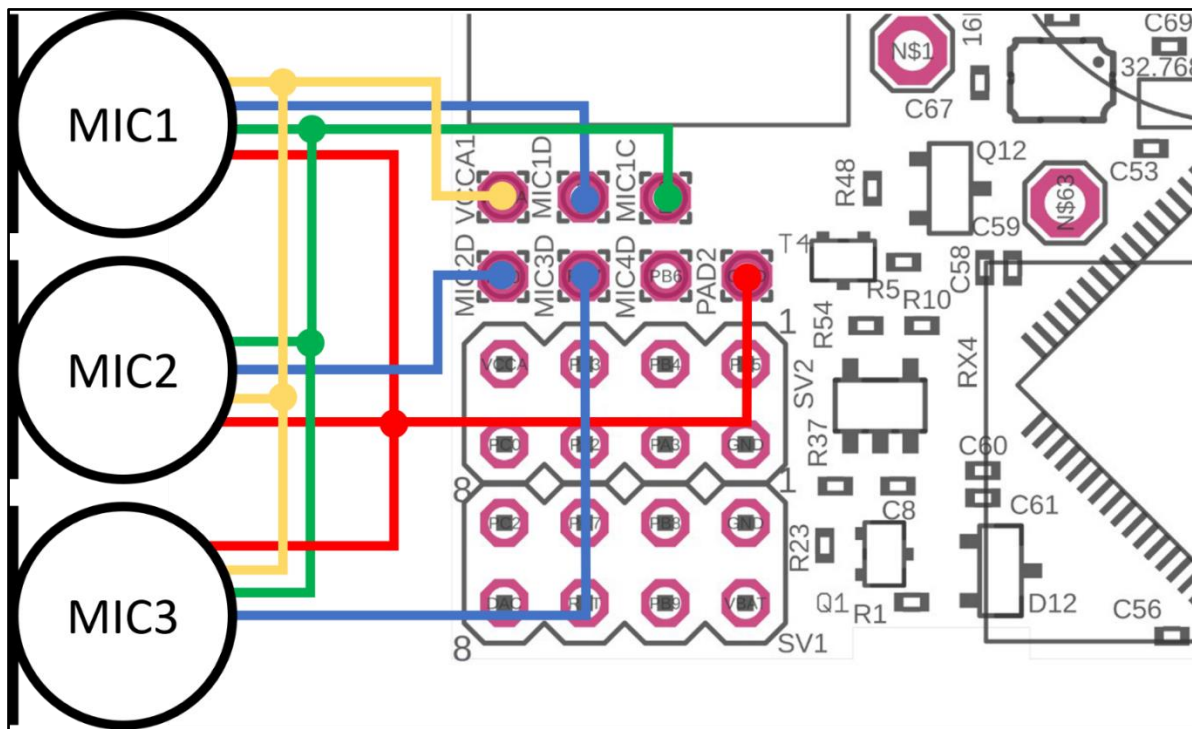

Figure 8: Two External Microphone connection

3.6.2. Beacon Mini-RX

The Beacon Mini-RX can be used in both the Non-Inverse Architecture (NIA) and in the Inverse Architecture (IA): [NIA and IA comparison](#)



The Mini-RX beacon HW differs from the regular Beacon HW v4.9 in several ways:

- It is an RX-only beacon, i.e. it can receive, but it cannot transmit ultrasonic signal
- The fact that it is RX-only makes it far more sensitive, i.e. you will get a longer range between Beacon HW 4.9 and Mini-RX than between Beacon HW 4.9 and Beacon HW 4.9.
- Mini-RX beacon can receive any ultrasonic frequency from the bands: 19kHz, 22kHz, 25kHz, 28kHz, 31kHz, 34kHz, 37kHz, 45kHz. The filter can be simply selected in the Dashboard. At the same time, the working ultrasonic frequency of Beacon HW v4.9 is HW-defined by ultrasonic sensors and can't be changed
- Mini-RX beacon can receive several ultrasonic frequencies at once. That is used in Inverse Architecture. See the comparison: [NIA and IA comparison](#)
- The Mini-RX Beacon is significantly smaller than Super-Beacon
- Can play a role of stationary beacon when imputing coordinates manually (in NIA)
- Can play a role of mobile beacon (in IA system)
- Has digital microphone, which is more sensitive than regular sensors
- Supports 868/915MHz radio only
- Light weighted
- Can be [water-protected](#)
- The component of the [Marvelmind Helmet](#) and [Marvelmind Watch](#)
- It has 360° reception angle (horizontally) and 180° reception angle (vertically)

Reception diagram. Digital microphone has about 360° (horizontally) and 180° (vertically) reception angle

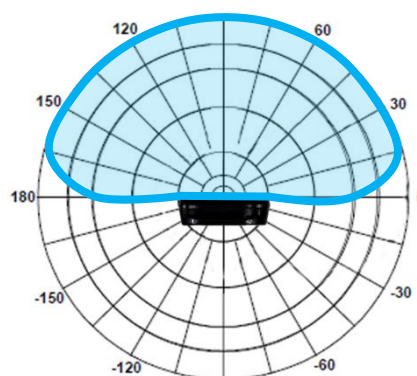
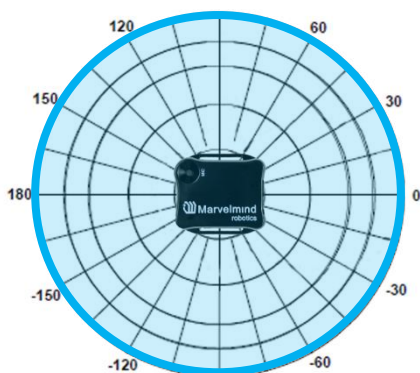

Mini-RX beacon may be over discharged. In that case do the following:

Turn off the beacon with DIP switches and charge it for 1 hour. Then turn the beacon on, flash the latest SW via DFU Programming and charge it for 1 hour again

3.6.2.1. How to flash Beacon Mini-RX

When you receive Beacon Mini-RX, it is turned off. Open it, to get access to DIP switch.

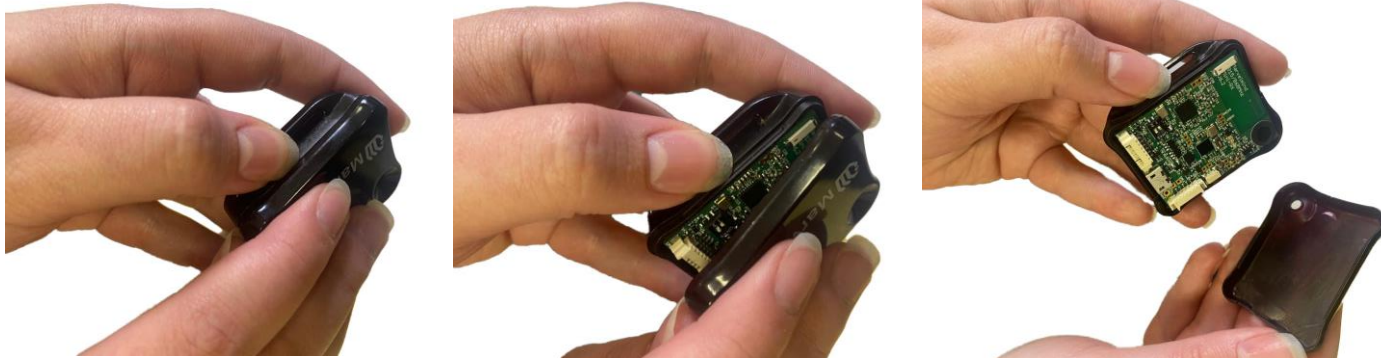

Put DIP switch to needed position:

- When DIP switch in this position – only charge of device is possible.

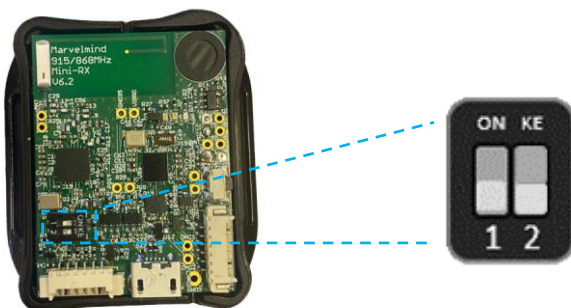

Put DIP switch to this position:

- To turn on the beacon
- For HEX programming (via Dashboard)

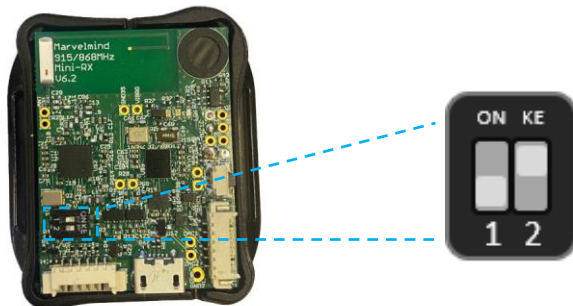

Put DIP switch to this position:

- For DFU programming (via: [DfuSe v3.0.5](#) or [DfuSe v3.0.6](#))

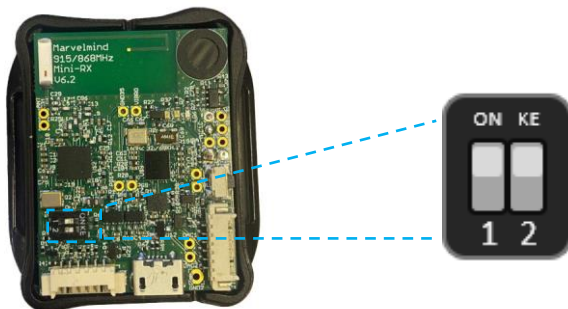

3.6.2.2. External microphone extension for Mini-RX

This modification of the Mini-RX beacon allows you to bring the receiving microphone to any place on the robot or clothing. Due to this, the microphone body itself will not interfere, and will not be visible. It allows you to create more accurate implantation.

It is also possible to use 2 external microphones to calculate the direction, or to improve and increase the reception area.

Length is 25cm (default), may be expanded up to 1m (optional). Check out the [product page](#).



Be careful: You should have soldering skills to solder external microphone on board

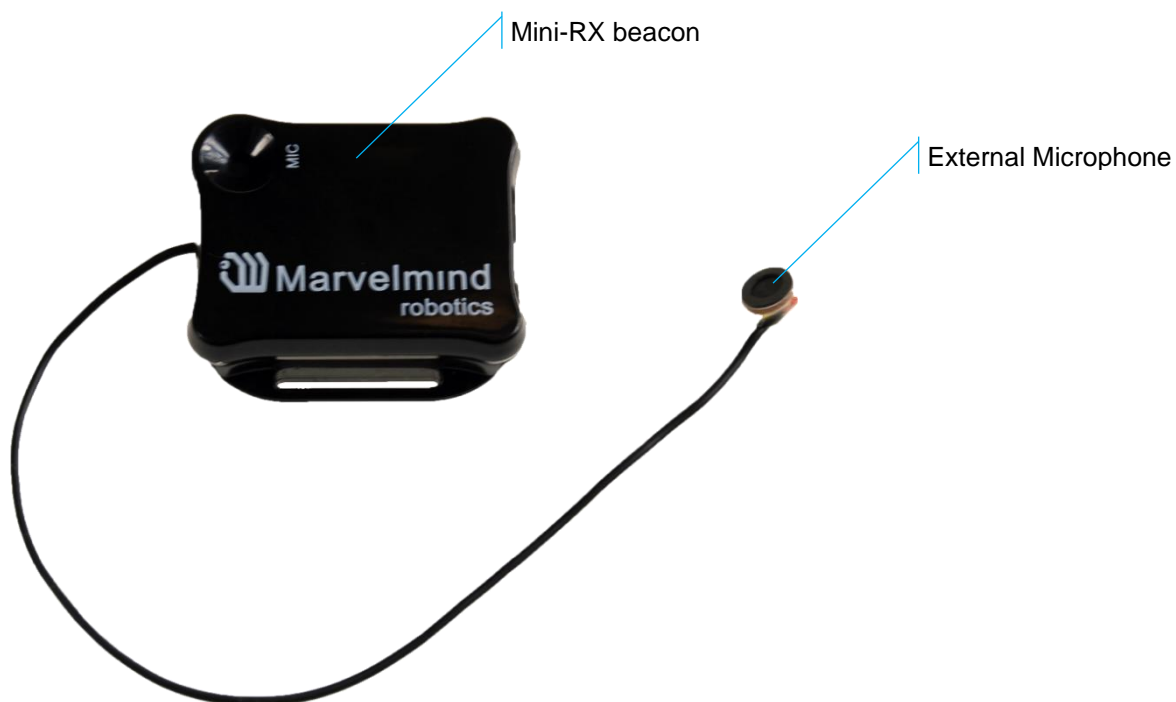

3.6.2.3. Dual microphones modification:

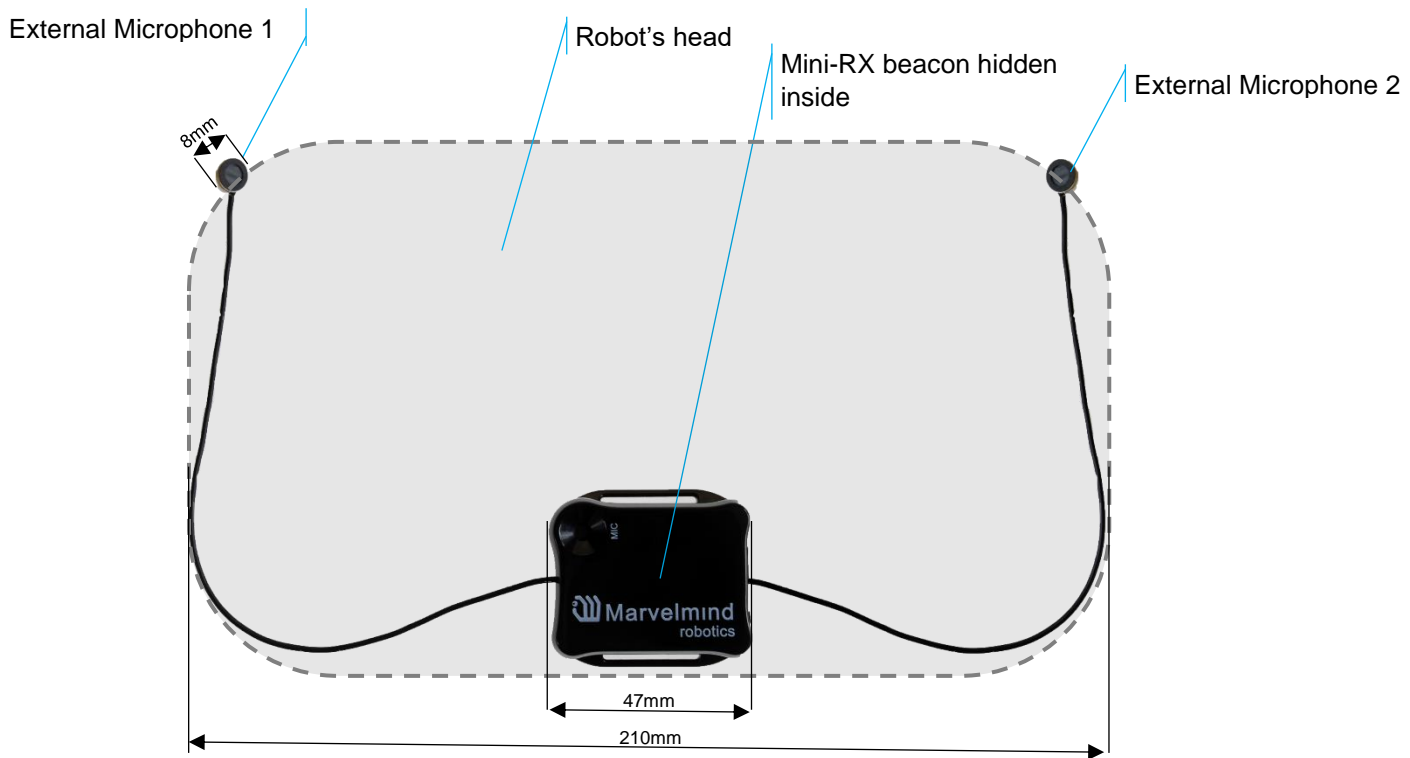

Figure 1: One external microphone with housing



Figure 2: Two external microphones with housing

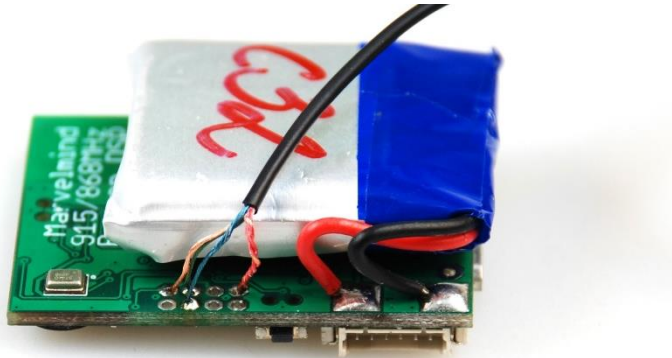

Figure 3: One external microphone soldering

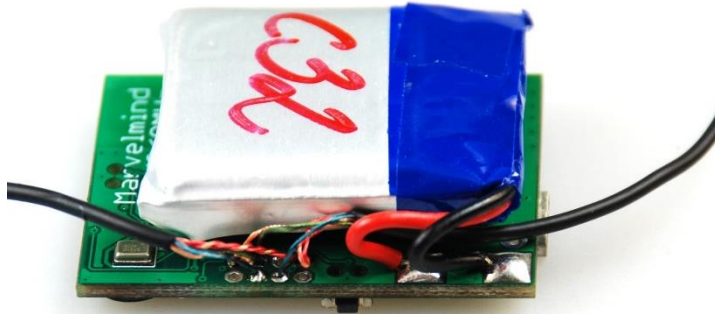

Figure 4: Two external microphones soldering

3.6.2.4. External microphones schemes:

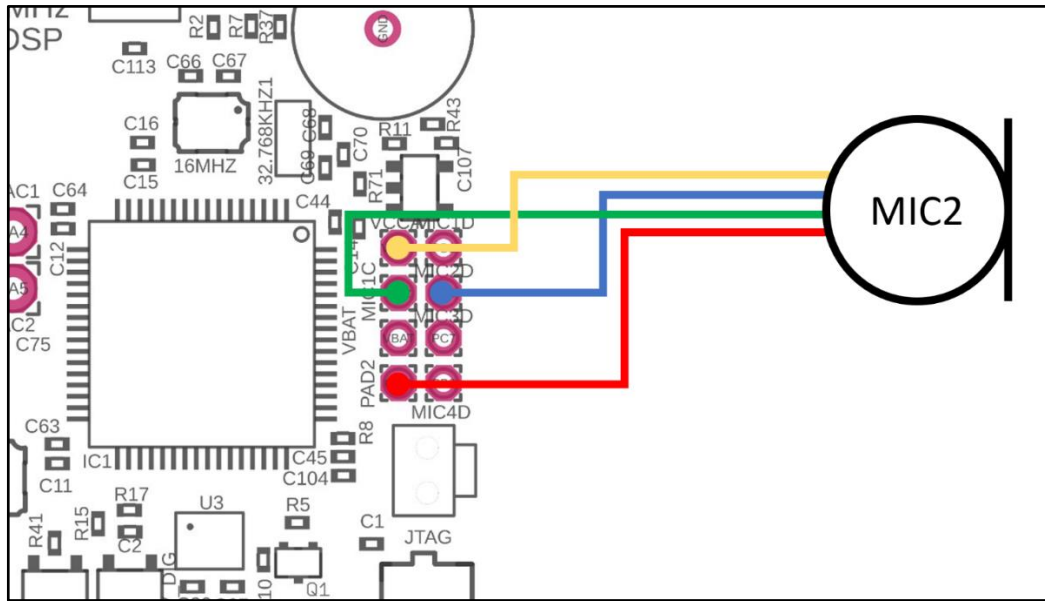

Figure 5: One External Microphone connection

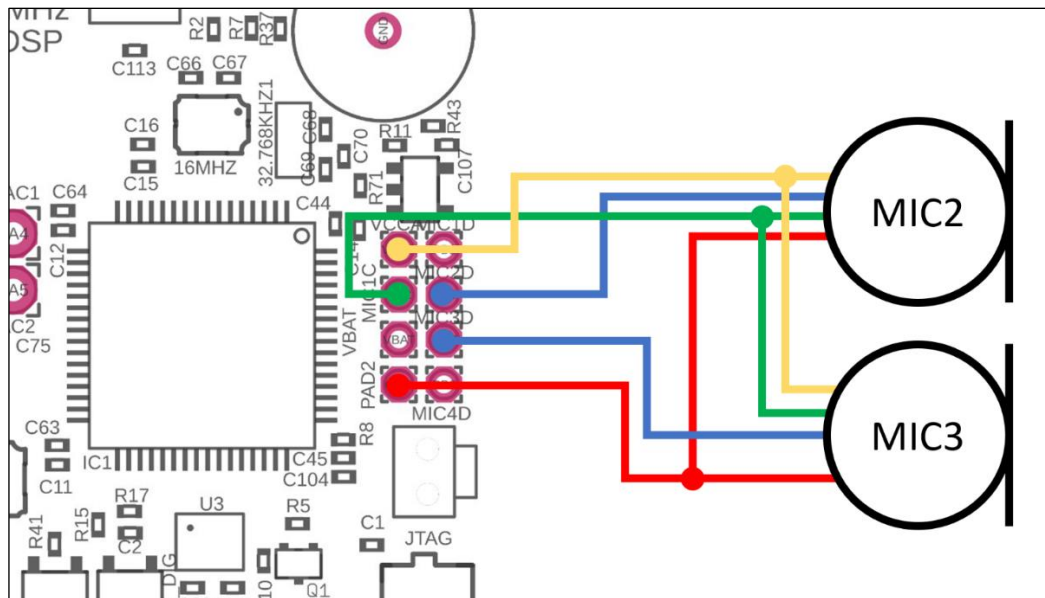

Figure 6: Two External Microphones connection



Figure 7: Two External Microphones final view



Figure 8: Two External Microphones final view

3.6.3. Beacon Mini-TX

The Mini-TX is a TX only beacon, i.e. it can transmit, but cannot receive ultrasound.

Comparison to Beacon HW v4.9:

- Smaller size and lighter: 47x42x15mm & 25g vs. 55x55x33mm & 62g (or 55x55x64mm with antenna)
- TX only, i.e. Mini-TX can only transmit ultrasonic and cannot receive. Beacon HW v4.9 is dual use: can receive and transmit ultrasonic
- Battery – 250mAh vs. 1000mAh in a regular beacon. But Mini-TX has a new more efficient ultrasonic TX module, thus, battery lifetime in TX mode is even superior to the Beacon HW v4.9
- Tested battery lifetime with 8Hz – 96h. With lower update rate – nearly proportionally longer. Very efficient ultrasonic TX module
- Mini-TX has only USB (virtual UART) output – no additional pins
- Mini-TXs always have embedded IMU – newer and better, but it has 3D accelerometer and 3D gyroscope, but no magnetometer (which we do not recommend using indoors anyway, due to magnetic field distortion indoor)
- Embedded antenna – smaller size, but smaller radio coverage ~50m with regular Modem HW v4.9 as compared with ~100m of Beacon HW v4.9 with Modem HW v4.9
- Range in ultrasonic is virtually on par with regular Beacon HW v4.9 – up to 30m with Beacon HW v4.9 as RX beacon. At the same time, for example, a combination of Mini-RX RX beacon + Mini-TX TX provide a better coverage and a stronger signal, than Beacon HW v4.9 + Beacon HW v4.9
- This HW is for the 868/915MHz band only, i.e. 433MHz is not supported and not planned



3.6.4. Beacon Industrial-TX-Metal

Do not disassemble the Industrial beacons. Otherwise, warranty will be lost

- TX-only beacon – can transmit ultrasonic, but can't receive it
- Electronics is IP67 protected
- Special IP67-protected 25kHz transducers
- External antenna with SMA connector for extended radio range
- Corresponding IP67 connectors (male part) included
- No battery inside
- Extended working temperature range from -40°C to +50°C (not tested, provided by design)
- Embedded reset switch and DFU switch – magnetic control
- Two IP67 external connectors:
- Modification (After June 2022) for versions 2 and 3

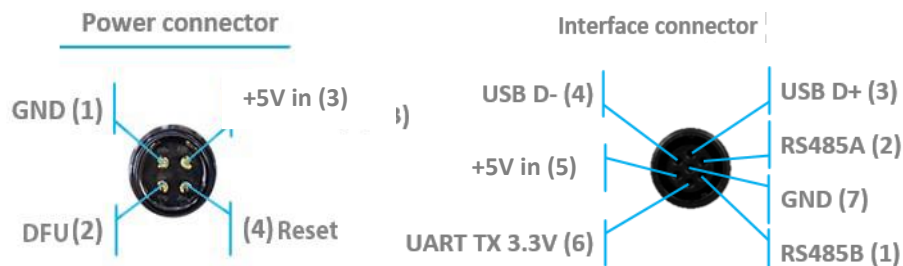

Version 2 and 3 of Industrial-TX-Metal (from June 2022) **supports ONLY +5V power supply**. Don't use +12V power supply converter for this version, it will burn the beacon!

This version doesn't have UART RX, but now is possible to use Interface connector as a power supply.

- RS485 modification pinouts (After Sep.2019)

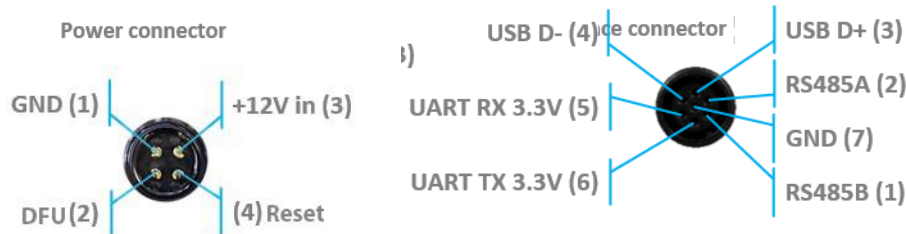

- RS485 modification pinouts (Before Sep.2019)



- CAN modification pinouts



- Can work with any Mini-RX beacon or Beacon HW v4.9 with 25kHz ultrasonic sensors (radio bands must match)
- Most of all designed to work together with [Outdoor versions of Mini-RX](#) beacons and heavy outdoor Industrial-TX and Industrial-RX beacons (radio bands must match)
- Up to 30m with Beacon Mini-RX
- Optional external [Converter-220V-12V-IP67](#) (except version from April 2022, it supports only +5V power supply)
- Wide transmitting diagram

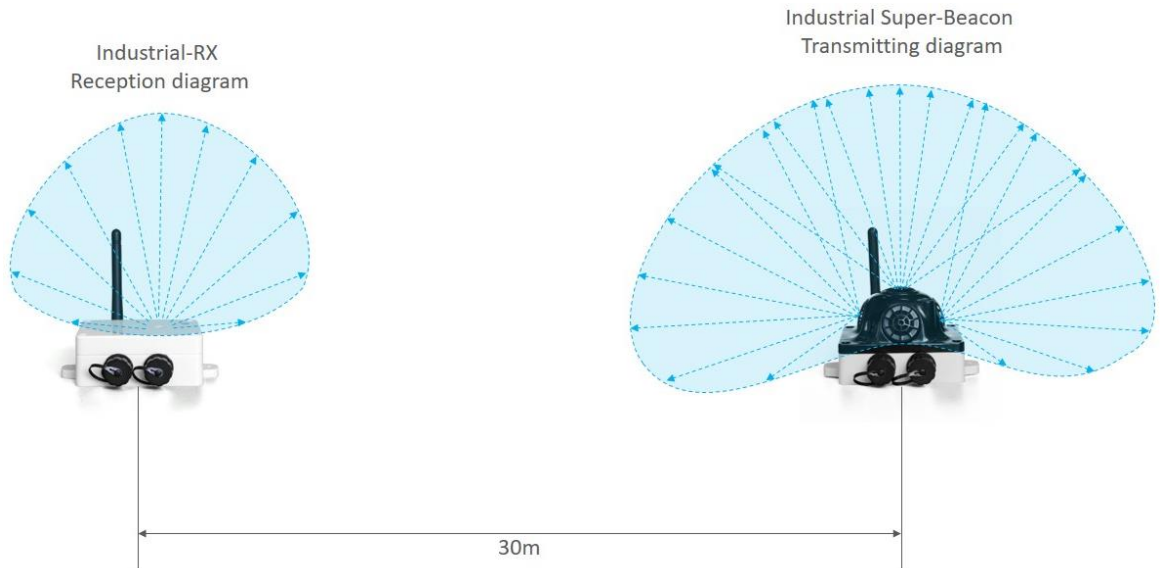

Determine carefully the version of your Industrial beacons: it may be built before September 2019 and after September 2019. If it is beacon from the late batch, you must use Industrial Super-beacon SW. if you have beacons from the early batch, use Industrial-RX or Industrial-TX SW. Stickers' differences: Later batch – Ind-RX-S or Ind-TX-S. Early batch – Beacon Ind-RX or Beacon Ind-TX.

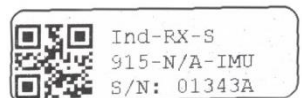
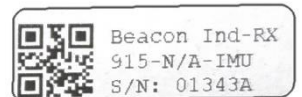

Version 2 and 3 of Industrial-TX-Metal (from June 2022) **supports ONLY +5V power supply**. Don't use +12V power supply converter for this version, it will burn the beacon!

This version doesn't have UART RX, but now is possible to use Interface connector as a power supply.

3.6.5. Beacon Industrial-RX

Do not disassemble the Industrial beacons. Otherwise, warranty will be lost

- RX-only beacon – can receive ultrasonic, but can't transmit it
- Electronics is IP67 protected
- Special IP67-membrane for ultrasonic sensor
- External antenna with SMA connector for extended radio range
- Corresponding IP67 connectors (male part) included
- No battery inside by default – external power bank or external power supply (+12V or +5V). But, optional variant with internal battery is possible (**except version from April 2022, it supports only +5V power supply**)
- Two IP67 external connectors:
- Modification (**After April 2022**)

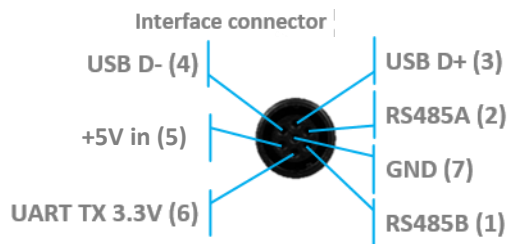
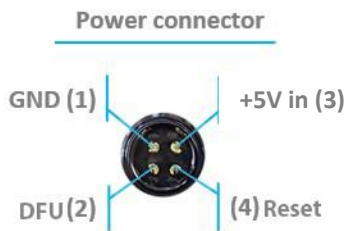

Version 3 of Industrial RX (from April 2022) **supports ONLY +5V power supply**. Don't use +12V power supply converter for this version, it will burn the beacon!

This version doesn't have UART RX, but now is possible to use Interface connector as a power supply.

- RS485 modification pinouts (**After Sep.2019**)

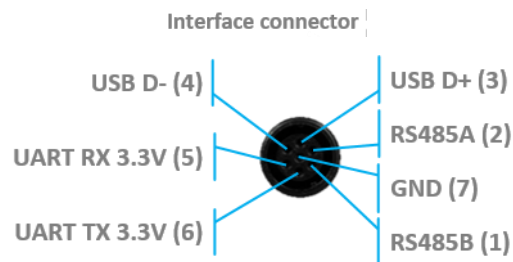
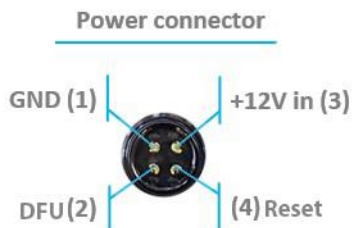

- RS485 modification pinouts (Before Sep.2019)



- CAN modification pinouts



- Extended working temperature range from -40°C to +50°C (not tested, provided by design) – only for the version without battery
- Embedded reset switch and DFU switch – magnetic control
- Supports wide range of ultrasonic frequencies: 19/22/25/28/31/34/37/45kHz
- Most of all designed to work together with [Outdoor versions of Mini-RX](#) beacons and heavy outdoor Industrial-TX and Industrial-RX beacons (radio bands must match)
- Optional external [Converter-220V-12V-IP67](#) (except version from April 2022, it supports only +5V power supply)
- Wide reception diagram

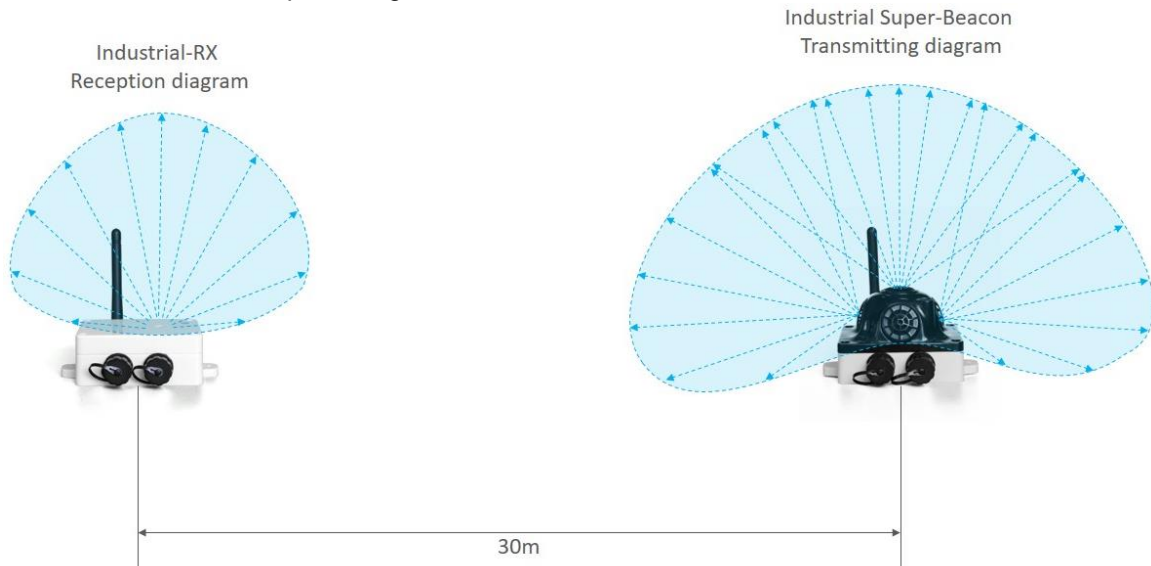

Uploading Beacon's Industrial-RX or Beacon's Industrial-TX SW to Industrial Super-beacon may permanently damage Industrial Super-beacon board.



Determine carefully the version of your Industrial beacons: it may be built before September 2019 and after September 2019. If it is beacon from the late batch, you must use Industrial Super-beacon SW. if you have beacons from the early batch, use Industrial-RX or Industrial-TX SW. Stickers' differences: Later batch – Ind-RX-S or Ind-TX-S. Early batch – Beacon Ind-RX or Beacon Ind-TX.

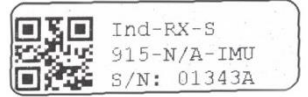
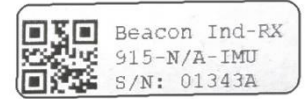

Version 2 and 3 of Industrial-TX-Metal (from June 2022) **supports ONLY +5V power supply**. Don't use +12V power supply converter for this version, it will burn the beacon!

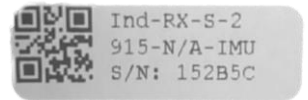

This version doesn't have UART RX, but now is possible to use Interface connector as a power supply.

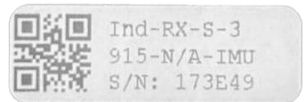

3.6.6. Industrial Super-Beacon Metal-25kHz

Do not disassemble the Industrial beacons. Otherwise, warranty will be lost

- Supports dual-use – RX and TX beacon. It can transmit on its native ultrasonic frequency (25kHz) and it can receive on any ultrasonic frequency via an embedded RX sensor – like Industrial-RX or Mini-RX does. Effectively, the Industrial Super-Beacons beacons combines inside an Industrial-TX and Industrial-RX. Additionally, the beacon supports both AI and NIA architectures. Thus, it is called Industrial Super-Beacon
- Electronics is IP67 protected
- Special IP67-protected 25-kHz transducers
- External antenna with SMA connector for extended radio range
- Corresponding IP67 connectors (male part) included
- No battery inside
- Extended working temperature range from -40°C to +50°C (not tested, provided by design)
- Embedded reset switch and DFU switch – magnetic control
- Two IP67 external connectors:
- Modification (After April 2022)

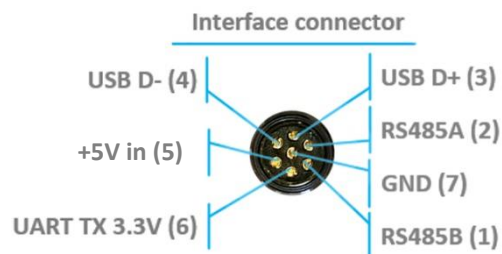
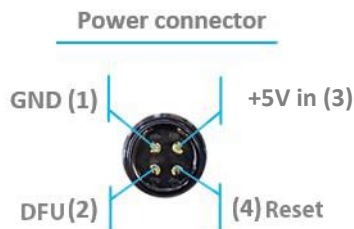

- Version 3 of Industrial RX (from April 2022) **supports ONLY +5V power supply**. Don't use +12V power supply converter for this version, it will burn the beacon!
- This version doesn't have UART RX, but now is possible to use Interface connector as a power supply.

- RS485 modification pinouts

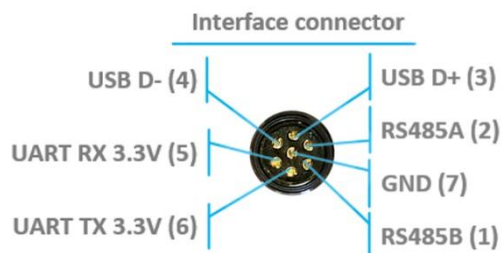
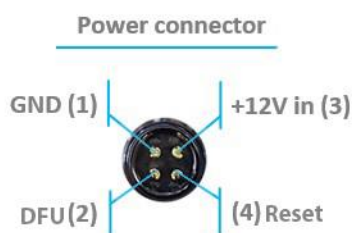

- Can work together with modems with corresponding radio (radio bands must match)
- Can work with any Mini-RX beacon or Beacon HW v4.9 with 25kHz ultrasonic sensors (radio bands must match)



- Most of all designed to work together with [Outdoor versions of Mini-RX](#) beacons and heavy outdoor Industrial-TX and Industrial-RX beacons (radio bands must match)
- Up to 30m with Beacon Mini-RX



- Optional external [Converter-220V-12V-IP67](#) (except version from April 2022, it supports only +5V power supply)



Uploading Beacon Industrial's (Not super) DFU software to Industrial Super-Beacon hardware make permanently damage for Industrial Super-Beacon board. Be double attentive with update



Version 2 and 3 of Industrial-TX-Metal (from June 2022) **supports ONLY +5V power supply**. Don't use +12V power supply converter for this version, it will burn the beacon!

This version doesn't have UART RX, but now is possible to use Interface connector as a power supply.

3.6.7. Beacon HW v4.9



Beacon HW v4.9 can be used in both the Non-Inverse Architecture (NIA) and in the Inverse Architecture (IA): [NIA and IA comparison](#)

Reception diagram. Each sensor has about 90° reception angle:

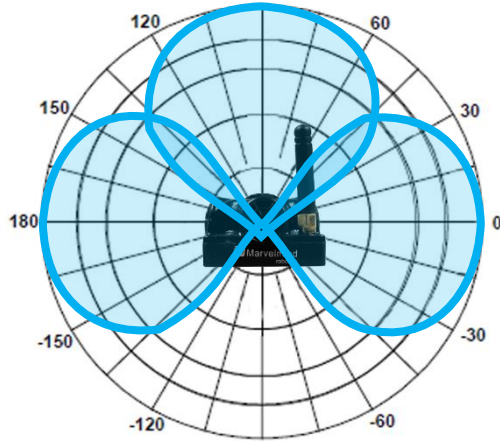

Figure 1: Transmitting diagram (with sensors)

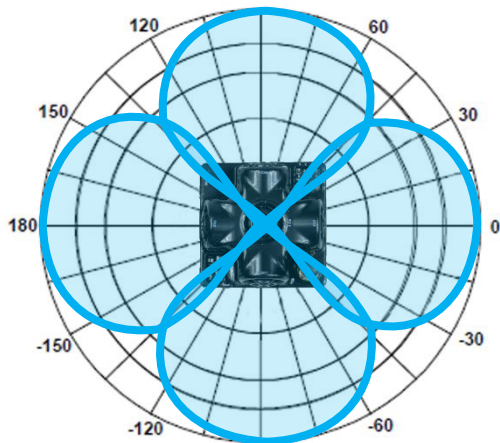

Figure 2: Transmitting diagram (with sensors)

4. Software pack

In this chapter you can find out how to use our [SW pack](#).

Always remember:

- All devices must be flashed from the same SW Pack
- Don't look on the dates in the name of file, they can be different, pay attention only to the name of the device.
- If the device was flashed with an older firmware version then Dashboard, this will be displayed in the diagnostic message window:

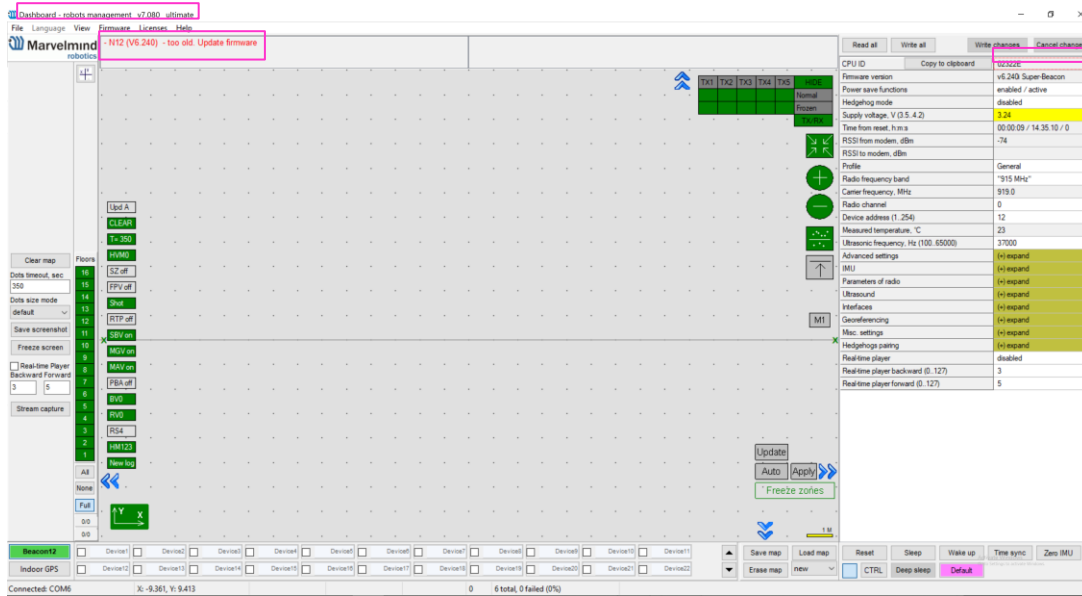

Changes in files in the Marvelmind SW pack (from SW version 7.200):

The SW files for beacons/modems that don't require an update with the new release won't be replaced with the new files in the new SW pack. However, the Dashboard will assign the new version number to them based on the newly introduced a SW version compatibility table. Thus, the files physically remain the same, but, if they are compatible with the latest SW pack, the Dashboard will automatically substitute their older SW version number with the latest SW version number

It is done in order to detect and avoid the most common mistake by the users – an attempt to run incompatible SW versions of beacons, modem, Dashboard obtained from different SW packs, i.e. not updating the beacons/modems to the latest SW version from the same SW pack upon getting the equipment from Marvelmind Robotics

Changes in naming of SW versions and licenses (from SW version 7.200):

Optional SW feature brought by MMSW0005 are now marked with L at the end of the release name. For example, v7.200 – only base SW features are enabled – by default. Purchasing the MMSW0005 license activates optional features and the SW version changes to v7.200L

Naming example IA vs. NIA: v7.200 and v7.200L – SW for NIA and MF NIA, v7.200i and v7.200Li – SW for IA

If some beacons/modems don't have the MMSW0005 license, their addresses are listed in the upper part of the Dashboard – information window

4.1. Download and open

- 4.1.1. Go to our web-site <https://marvelmind.com/> => <https://marvelmind.com/download/> and download the latest Marvelmind SW pack



- 4.1.2. Unzip pack and open a folder

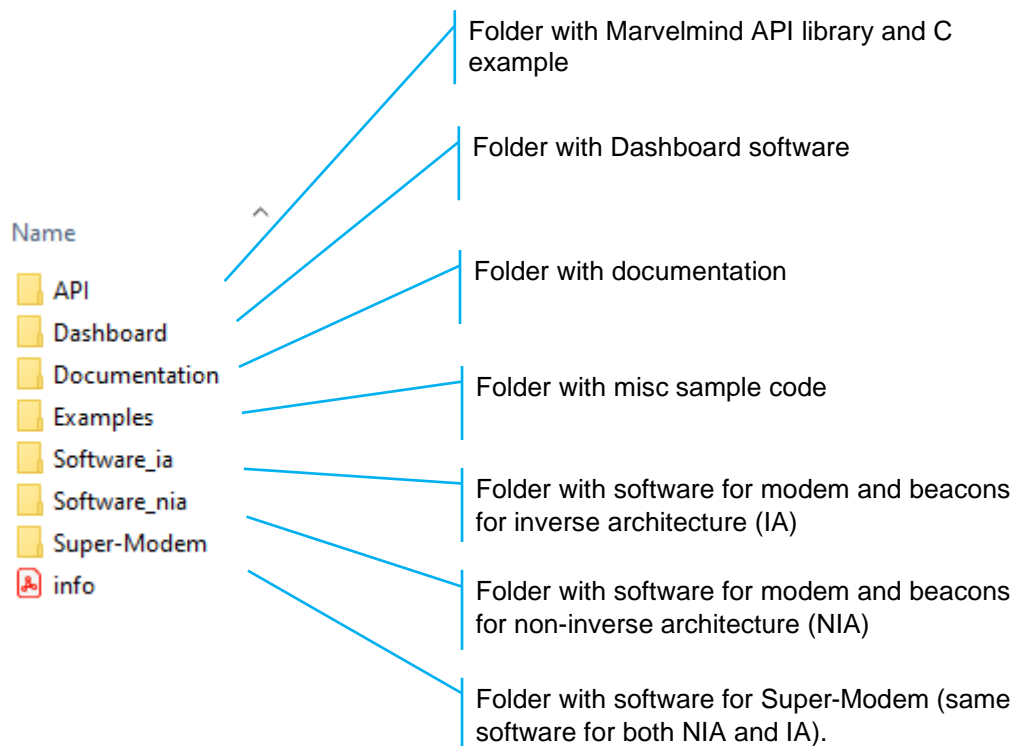

4.2. Dashboard folder

In this folder you can find all modifications of Dashboard.

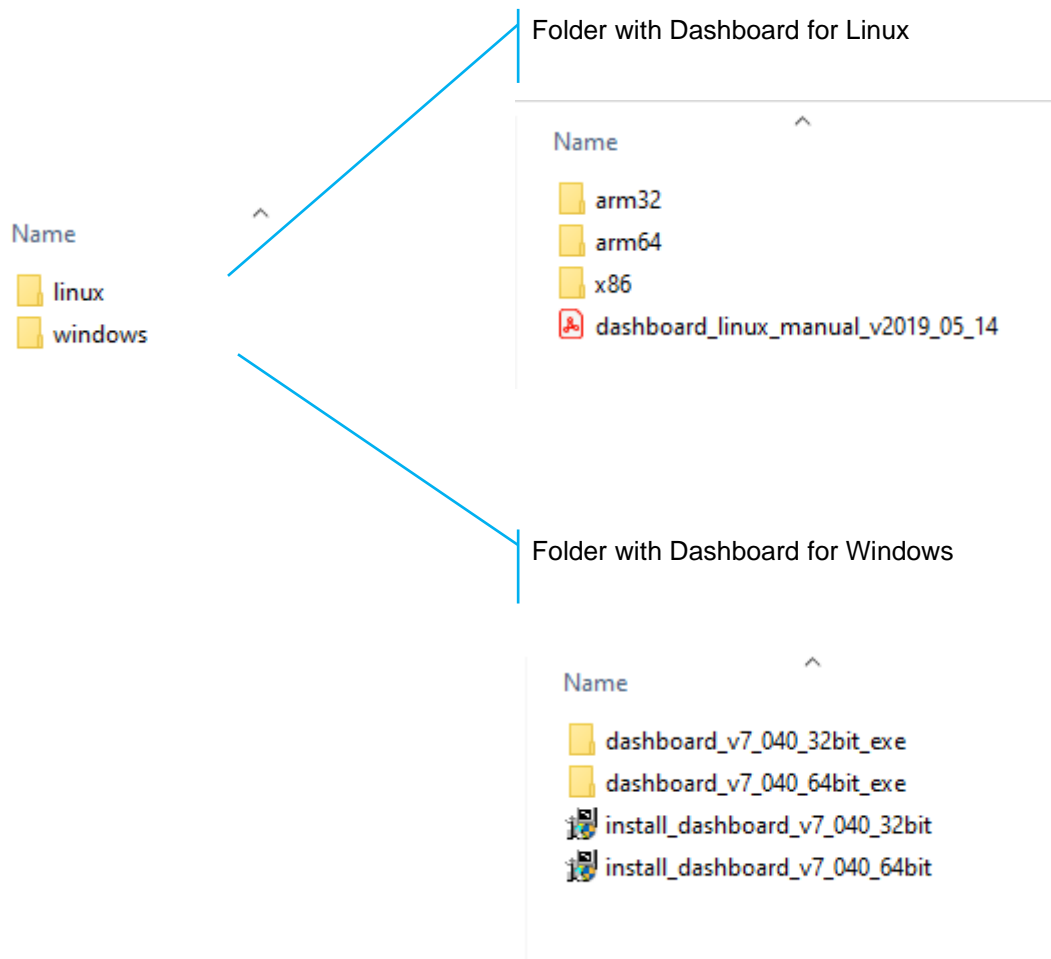

4.3. Software IA folder

In this folder you can find all software to flash devices to build a map in Inverse Architecture. Use this folder to flash sets:

- 1) [Starter Set IA-04-2D-Badge](#)
- 2) [Starter Set Super-MP-3D](#) in Inverse Architecture

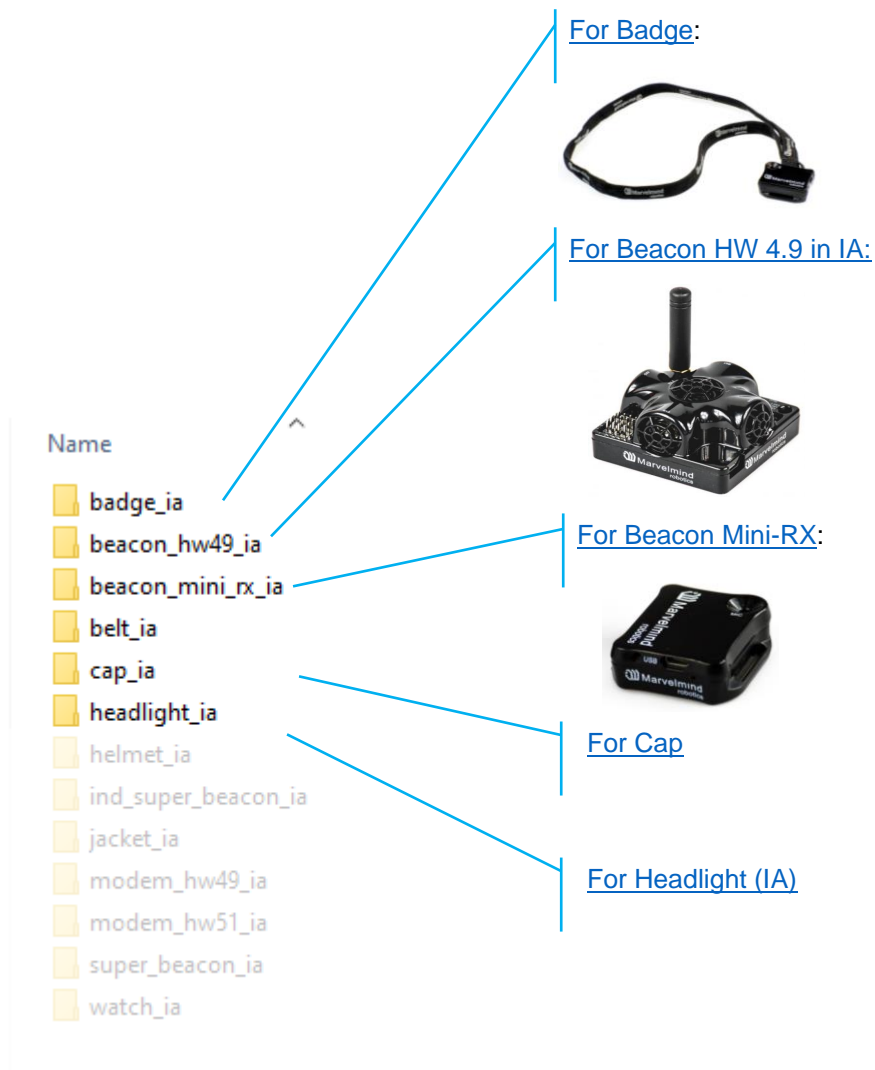

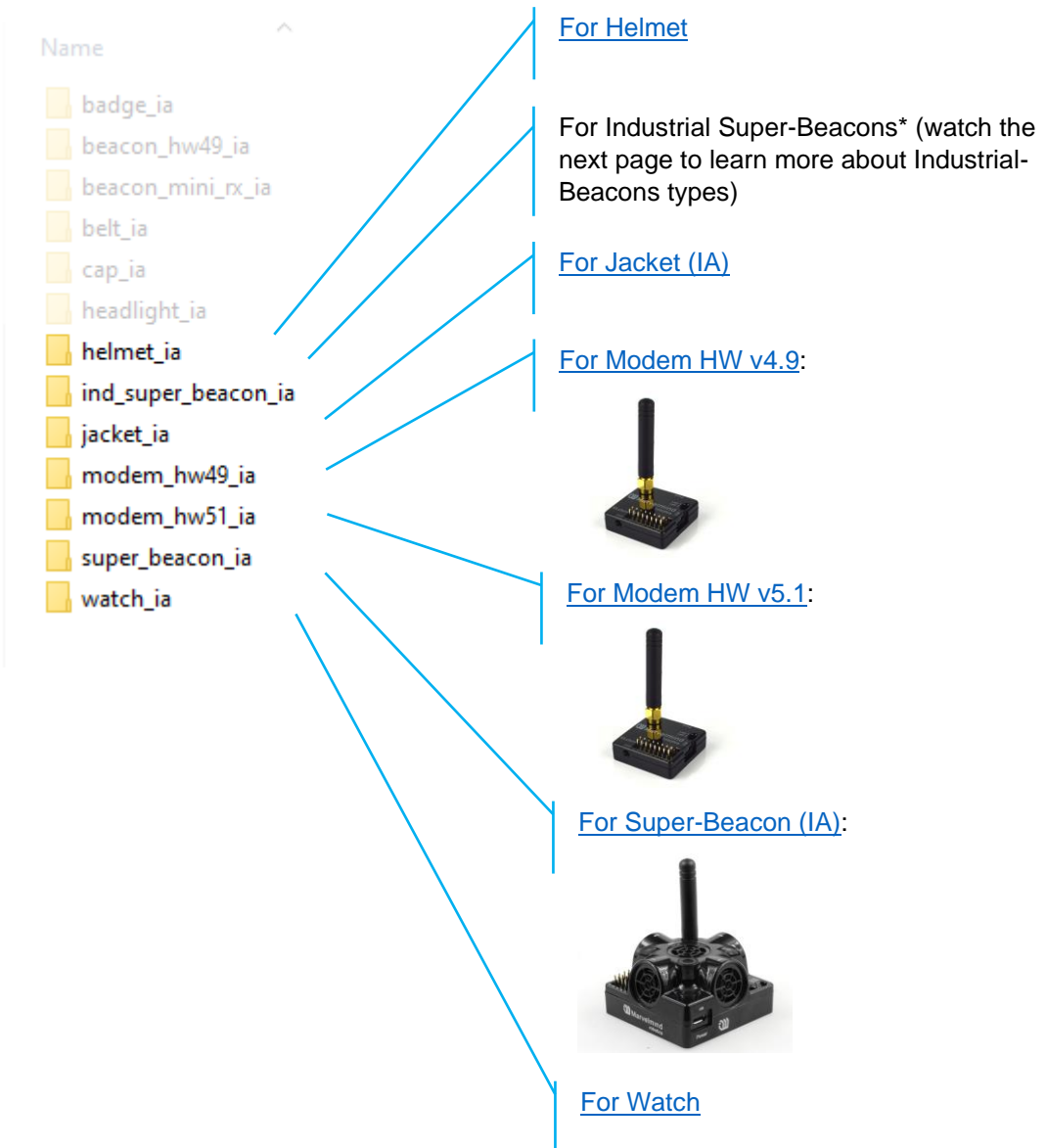

4.3.1. Types of Industrial-Super-Beacons:

- 1) [Beacon Industrial-RX:](#)



- 2) [Industrial Super-Beacon Metal-25kHz:](#)



- 3) [Industrial Super-Beacon-Plastic:](#)



4.4. Software NIA folder

In this folder you can find all software to flash devices to build a map in Non-Inverse Architecture. Use this folder to flash sets:

- 1) [Starter Set HW v4.9-NIA:](#)



- 2) [Starter Set NIA-SmallDrone:](#)



- 3) [Starter Set Industrial-NIA-01:](#)



- 4) [Starter Set Super-MP-3D in NIA:](#)



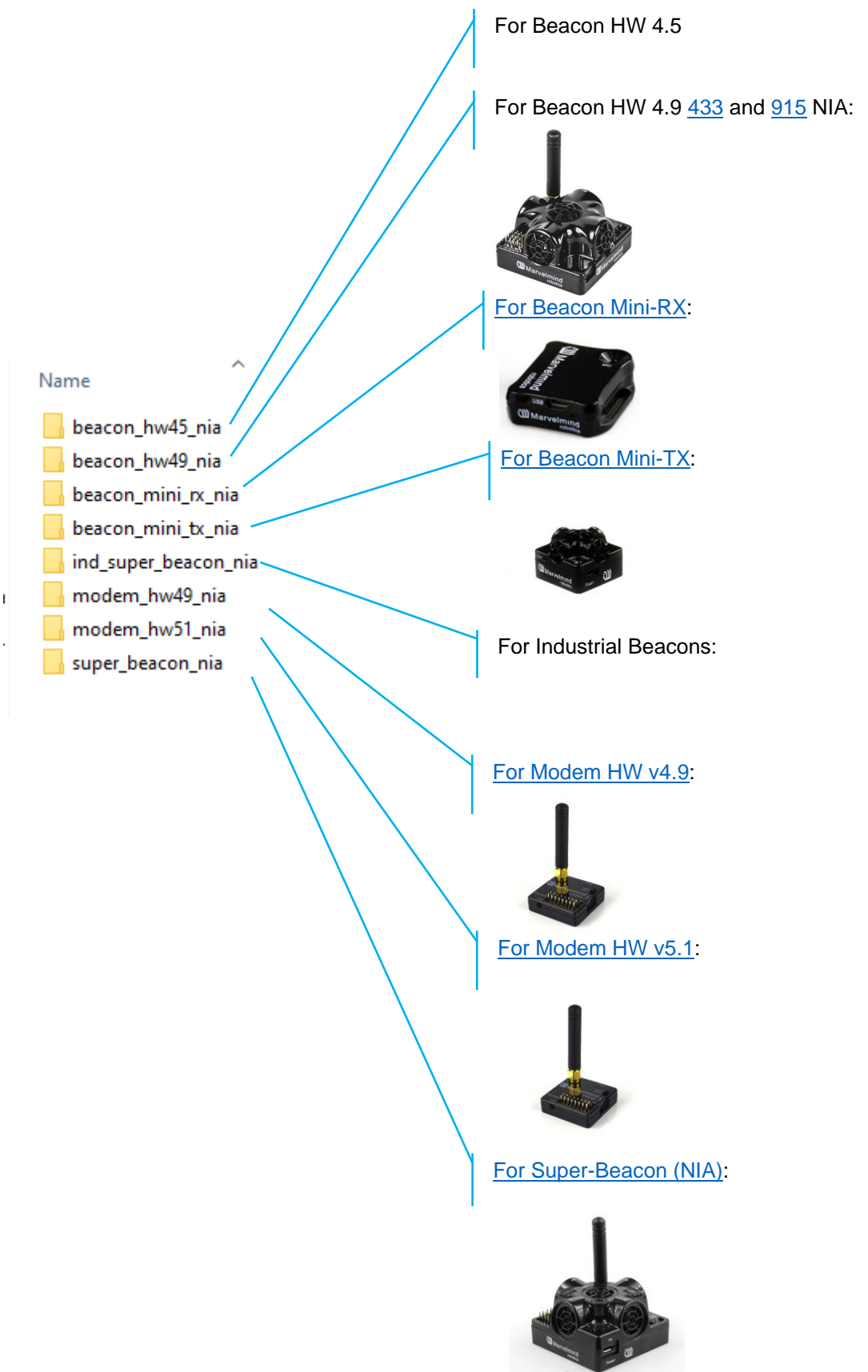

4.5. Super-Modem folder

Folder with Super-Modem software (same software for both NIA and IA).

Warning! If your current Super-Modem software version is less than 7.000, you need to reflash micro-SD card inside the Super-Modem for update. Super-Modem Micro-SD card image is supplied in separate archive, because it is pretty large.

After SW release v7.040 you can flash Super-Modem via Dashboard. Flash both levels – high and low.

Please refer to downloads page and [download SW for Super-Modem](#)

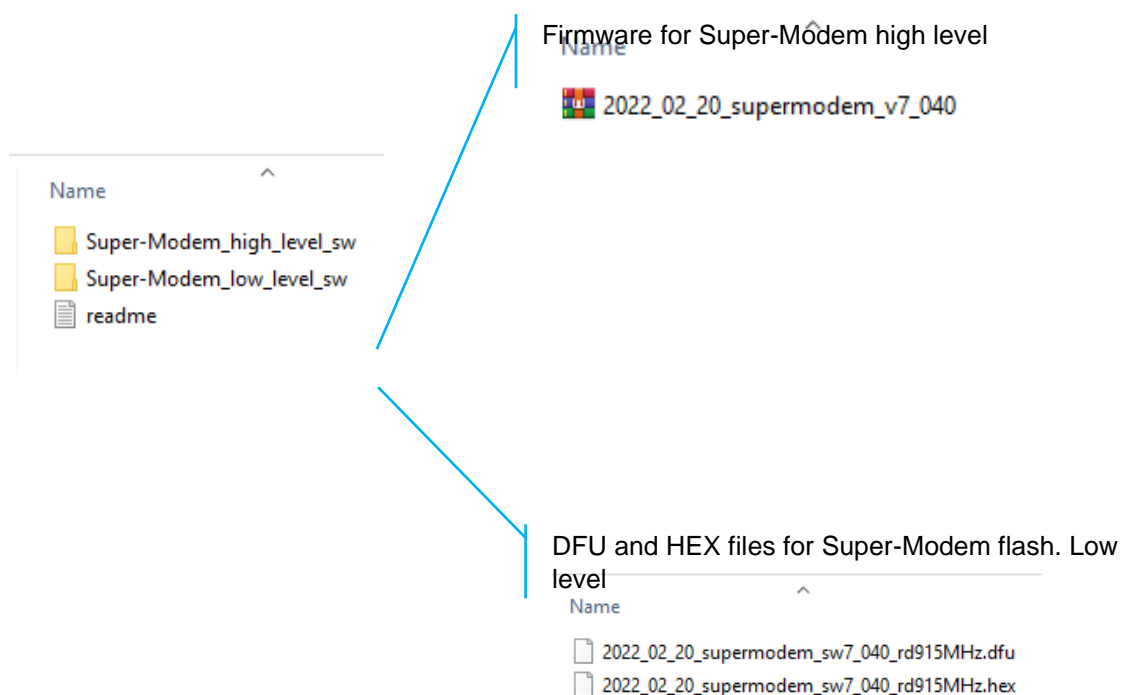

5. SW settings descriptions

5.1. Super-Modem's SW update and configuration description

5.1.1. Super-Modem's SW update

Do not disassemble the Super-Modem before you check the SW version installed. First of all, check if the SW version of your Super-Modem is up to date (Latest version on the [Marvelmind Downloads page](#)). If not – update the software as described below

Marvelmind Super-Modem software consists of two parts:

- Low level firmware
- High level software for integrated Raspberry Pi single-board computer

Low level firmware is placed in general software package with all Marvelmind software in 'Super-Modem' folder. This firmware can be updated via dashboard (hex file) or via DFU (dfu file) like other firmware in the package. Please refer to Operating Manual for details of updating software via dashboard or dfu.

High level software is located on micro-SD card inserted in the Raspberry Pi single-board computer inside Super-Modem. To update this software, you should write on this micro-SD card the image of micro-SD card with updated software. You can download the image on downloads page (<https://marvelmind.com/download/>). The image is placed in archive separately from general software package because its size is pretty large (archive is about 1.5 - 2 GB).

Micro-SD card location



5.1.2. How to update Super-Modem (for SW version from v7.000)

In latest versions of SW it's possible to flash Super-Modem without disassembling.

- 5.1.2.1. Connect power Supply to Super-Modem and connect Super-Modem to PC via USB. Wait for 1 minute till it appears in Dashboard

Read all		Write all		Write changes		Cancel changes	
CPU ID	Copy to clipboard	0D3A1D					
Firmware version	v7.050i Super-Modem-2						
High level software version	v7.050i						
Architecture	IA						
Location update rate	8 Hz						
Supply voltage, V (4.5..13.0)	10.25						
Time from reset, h:m:s	00:01:04 / 19.03.42 / 0						

- 5.1.2.2. There are two Firmware versions – Low level (Firmware version) and High level (High level software version). Both of them should be flashed from the same pack.

The screenshot shows the Marvelmind dashboard interface. The main window is titled 'Dashboard - robots management v7.050 ultimate'. The 'Firmware' tab is active, displaying a table of device information. The table has columns for 'Read all', 'Write all', 'Write changes', and 'Cancel changes'. The data rows include: CPU ID (0D3A1D), Firmware version (v7.050i Super-Modem-2), High level software version (v7.050i), Architecture (IA), Location update rate (8 Hz), Supply voltage, V (4.5..13.0) (10.25), and Time from reset, h:m:s (00:01:04 / 19.03.42 / 0). The interface also shows a map on the left, a list of devices at the bottom, and various settings on the right.

- 5.1.2.3. Go to Firmware => Upload firmware

5.1.2.4. Update high level SW (from folder Super-Modem_high_level SW)

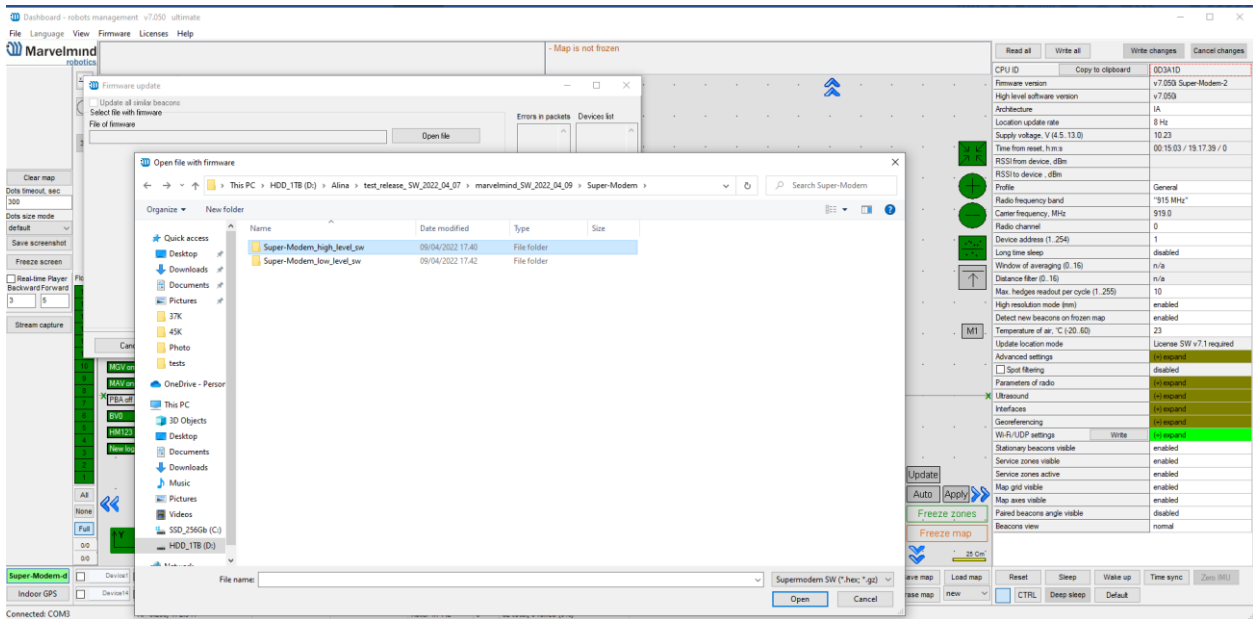

5.1.2.5. When high level flashing done, use file from folder Super-Modem_low_level_SW

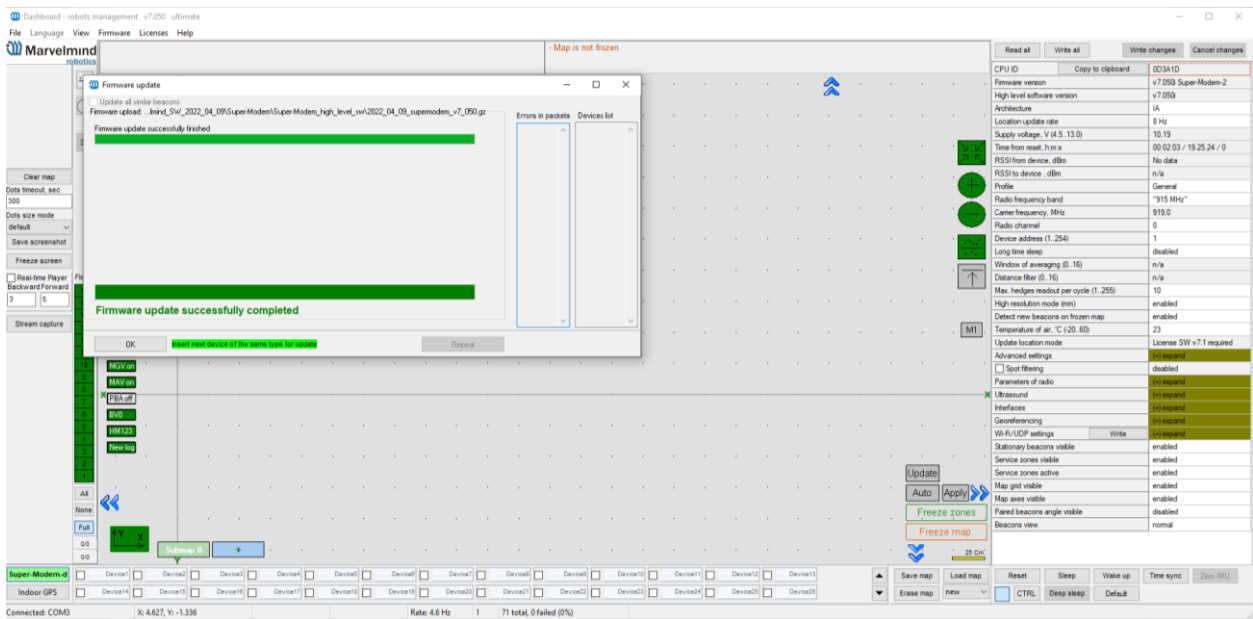

5.1.2.6. Press Default button after flashing of both levels.

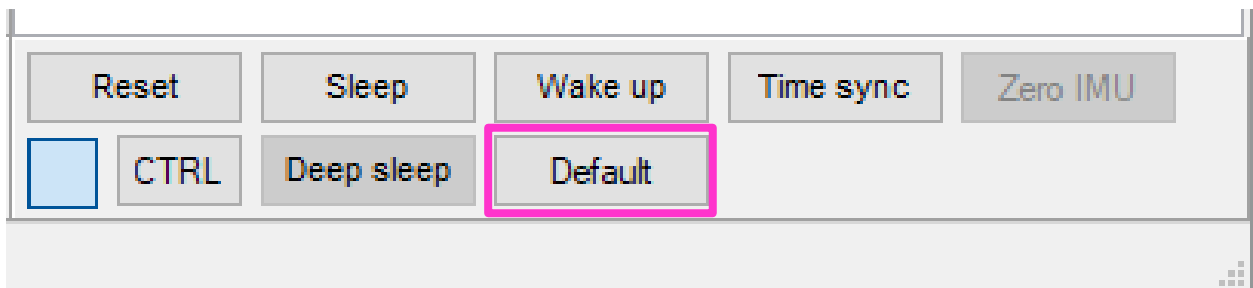

5.1.2.7. Firmware update successfully completed.

5.1.3. How to update Super-Modem's SW (for SW version older than v7.000):

Do not disassemble the Super-Modem before you check the SW version installed. First of all, check if the SW version of your Super-Modem is up to date (Latest version on the [Marvelmind Downloads page](#)). If not – update the software as described below

Follow the steps below to update Super-Modem's SW.

- 5.1.3.1. Open Super-Modem enclosure
- 5.1.3.2. Eject the micro-SD card (Super-Modem should not be powered at this time)
- 5.1.3.3. Insert micro-SD card into any MS Windows computer via card reader
- 5.1.3.4. Download and unpack the archive with image of updated software

Name	Date modified	Type	Size
Super-Modem_high_level_sw	03/08/2022 18.16	File folder	
Super-Modem_low_level_sw	31/07/2022 18.25	File folder	
Super-Modem_SD_image	03/08/2022 19.32	File folder	
2022_02_08_supermodem_config_files	08/02/2022 23.00	Adobe Acrobat D...	193 KB
2022_02_08_supermodem_software_update	08/02/2022 22.51	Adobe Acrobat D...	294 KB

- 5.1.3.5. Install and run Win32 disk imager program (supplied in the archive with image)
- 5.1.3.6. Open the image file and write to the micro-SD card (see screenshot below)

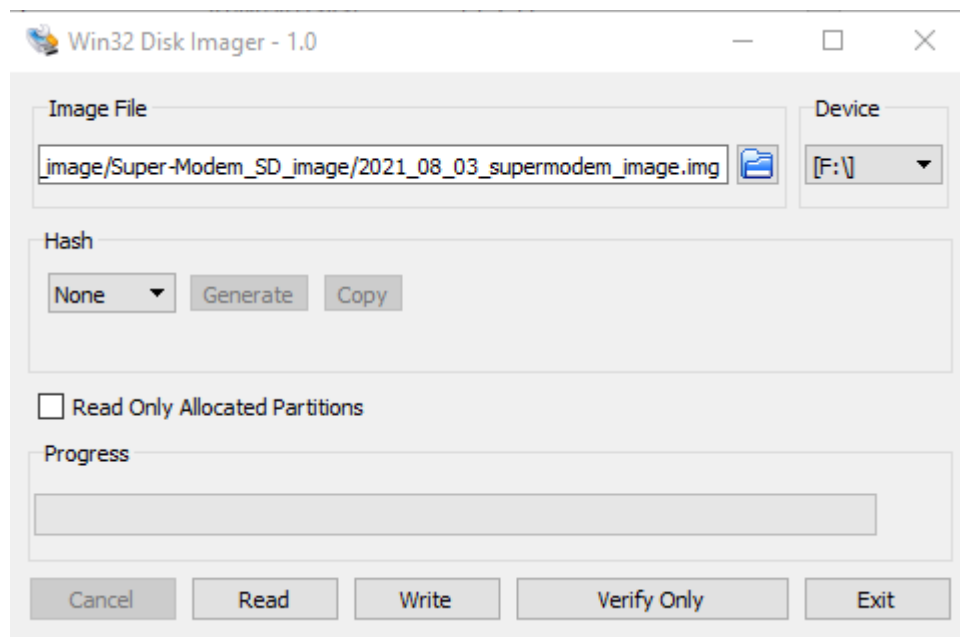

- 5.1.3.7. Eject micro-SD card from computer and insert back into Super-Modem
- 5.1.3.8. Close Super-Modem enclosure

5.1.4. Super-Modem's configuration

Do not disassemble the Super-Modem before you check the SW version installed. First of all, check if the SW version of your Super-Modem is up to date (Latest version on the [Marvelmind Downloads page](#)). If not – update the software as described below

Marvelmind Super-Modem contains Raspberry Pi single-board computer with corresponding software. Some settings can be modified via configuration files on the micro-SD card inserted in the Super-Modem.

To modify these files, you need to:

- Open Super-Modem enclosure
- Eject the micro-SD card (Super-Modem should not be powered at this time),
- Insert micro-SD card into any computer with Linux
- Open and modify certain configuration files on the micro-SD card (see below)
- Eject micro-SD card from computer and insert back into Super-Modem
- Close Super-Modem enclosure

Micro-SD card location



When you insert it into computer with Linux, required files are usually located by following path:

`/media/<user name>/rootfs/home/pi/supermodem:`

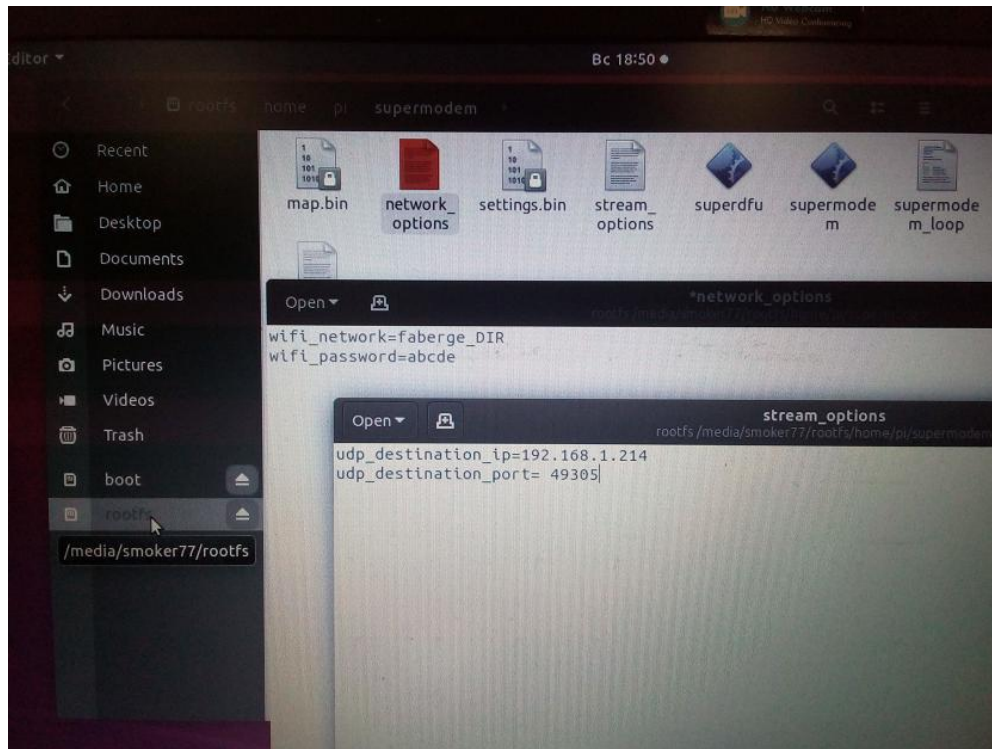

5.1.4.1. Super-Modem's settings descriptions

In file "network_options":

- **wifi_network** – name (SSID) of WiFi network to connect
- **wifi_password** – password (PSK) for this network

In file "stream_options":

- **udp_destination_ip** – IP address in local network where Super-Modem will stream data
- **udp_destination_port** – UDP port where Super-Modem will stream data

If you need more information about UDP streaming here -

https://marvelmind.com/pics/UDP_C_example.zip

5.2. SW update (USB/Radio/DFU)

This chapter describes three general ways of SW update. Regular - using USB connection, or Radio connection. And SW update for special cases (if SW version gap is very big, or regular SW update do not work) – DFU Programming.

5.2.1. SW update via USB

Usually, SW update via USB is used for the very first time you starting up the system. It allows you to make an update up to actual SW version very quickly before the system deployment.

Pros: Quick SW update per beacon.

Cons: All the devices should be connected to the PC via USB cable. If you already deployed the system, you will need to unmount it.

How to:

- Launch the Dashboard
- Make sure that the beacon is on
- Connect beacon to your PC via USB cable
- When beacon connected to the Dashboard, go to **“Firmware”** → **“Upload firmware”**

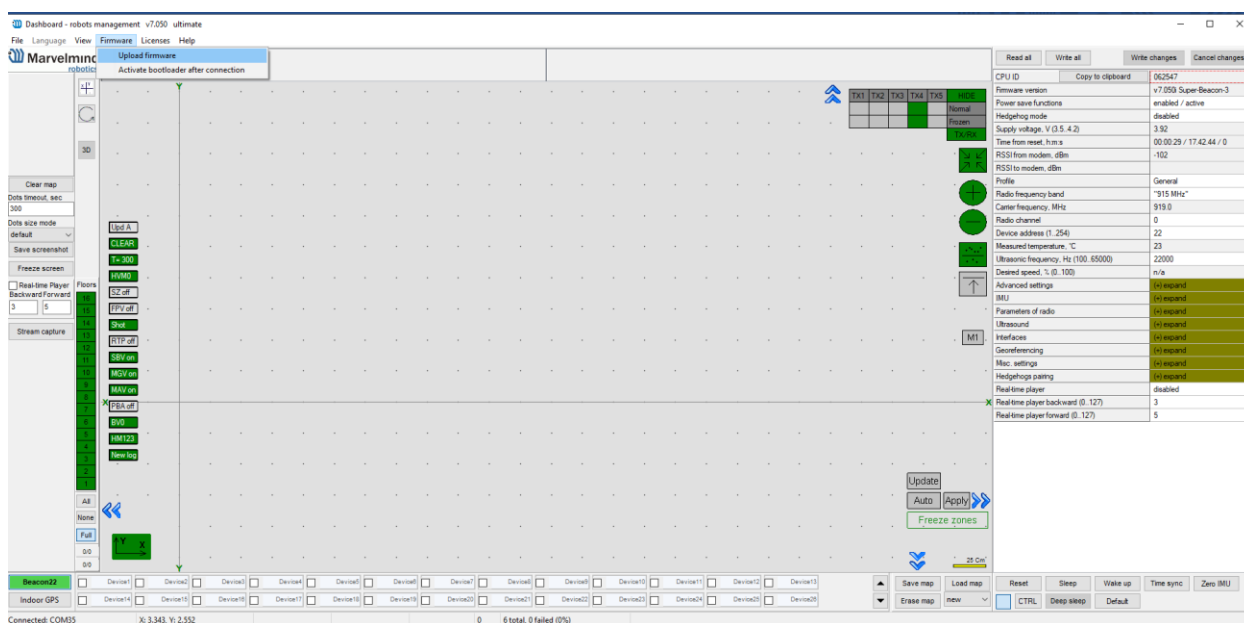

- Choose **.hex SW file for your device** (Be careful with IA and NIA architectures, do not mix it)
- Click **“Next”**

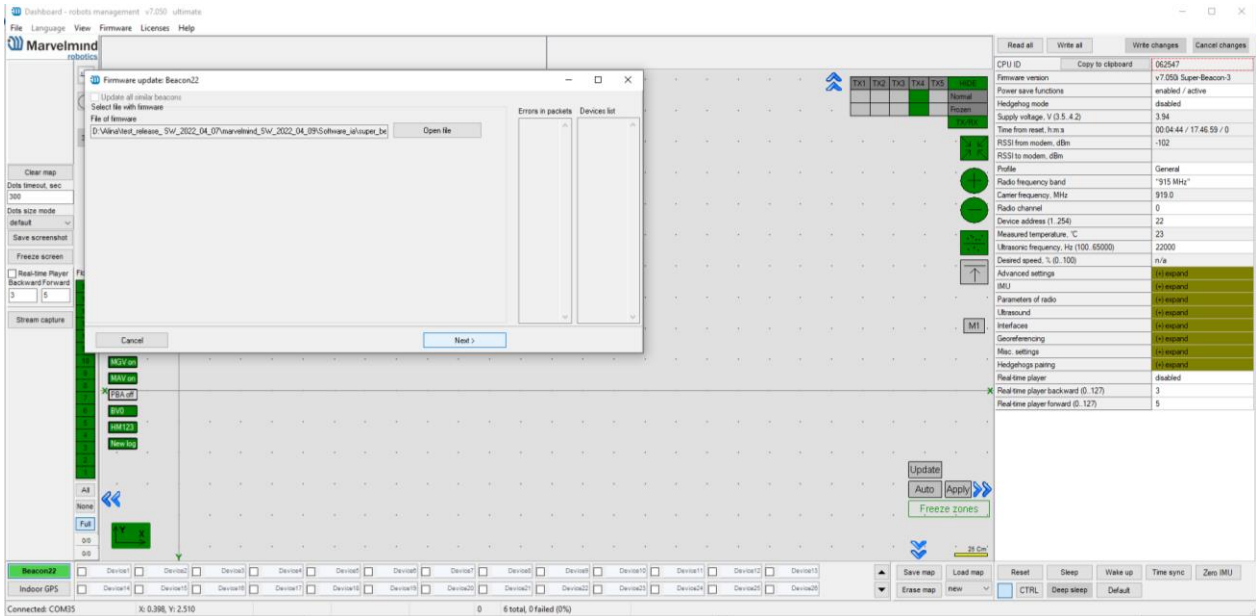

- Wait until beacon update finishes

Note: Press Default button for every beacon after SW update

- Repeat for all your beacons

Be careful: Default button will apply full default settings to this beacon, except it's address. If you had some custom Radio settings before, it would be changed to 153kbps Radio profile, 0 Radio channel

5.2.2. SW update via Radio

Usually, SW update via USB is used for the very first time you are starting up the system. It allows you to make an update up to actual SW version very quickly before system deployment.

Pros: Allows you to keep your system in its place and update SW remotely

Cons: Not as fast as USB SW update

How to:

- Launch the Dashboard
- Make sure that the modem is connected to the Dashboard (via USB)
- Ensure that you can see your beacons via radio in the Dashboard
- Click on the beacon you want to update (In the bottom devices' list)
- go to **"Firmware"** → **"Upload firmware"** → **Choose .hex SW file for your device**
(Be careful with IA and NIA architectures, do not mix them)
- Click **"Next"**
- Wait until beacon update finishes
- Repeat for all your beacons
 - Note: with additional license you can enable simultaneous update of multiple beacons (stationary and mobile)

5.2.3. SW update via DFU Programming



Not applicable to “Outdoor” versions of originally non-outdoor versions

Usually, SW update happen using regular USB or Radio SW update. But in case when you didn't update your system for a long time (and get a big SW version gap), or you faced with some unexpectable troubles – please do the DFU Programming SW update. This chapter describes DFU update for different types of devices.

Pros: Ultimatum SW update – erases all glitches, settings and etc. Makes it possible to revive beacon if “everything goes bad”

Cons: More complicated than a regular SW update, clears all settings – **Save map file not to lose your map**

To make a DFU Programming, you need to know where hardware reset button and DIP switches are placed.

5.2.3.1. Reset button and DIP switch placement

- Super-Beacon:

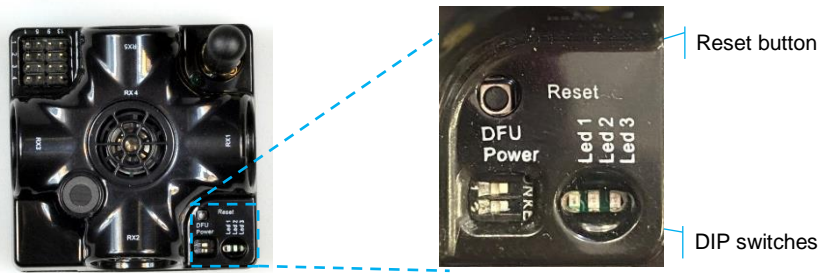

- HW v4.9 Beacon:



- Mini-RX beacon:



- Mini-TX beacon:

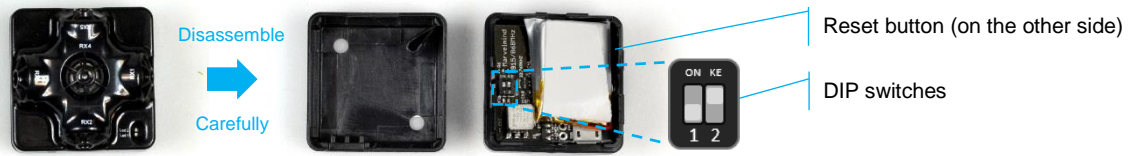

Industrial beacons have no switches and reset buttons, but they have magnetic DFU switch and magnetic Reset button:

- Industrial Super-Beacon-Plastic:



- Industrial Super-Beacon Metal-25kHz:



- Beacon Industrial-RX:

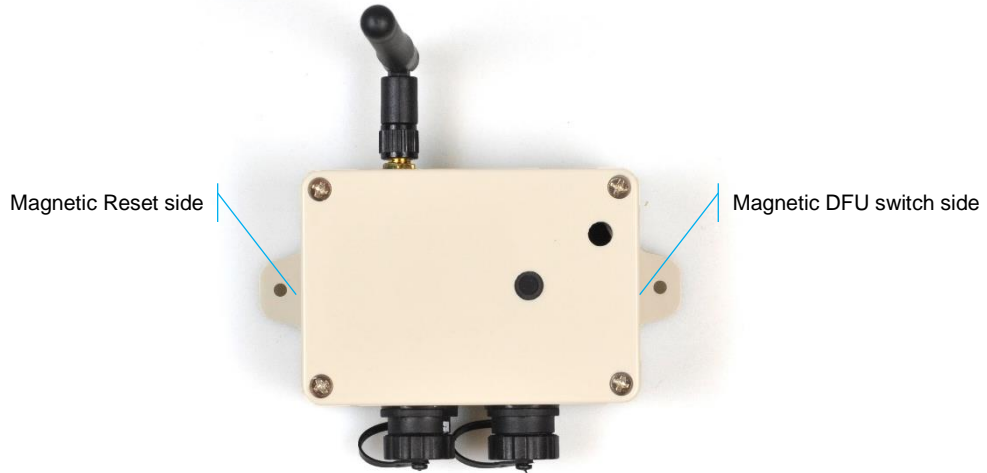

- How to enter into DFU mode and Reset different types of Modems:

- Modem HW v5.1:

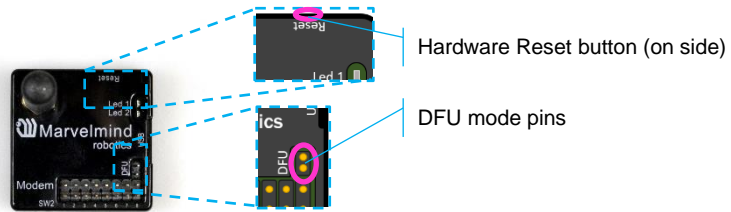

- Modem HW v4.9:

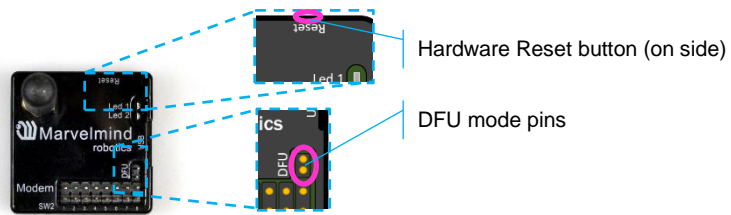

- Super-Modem:

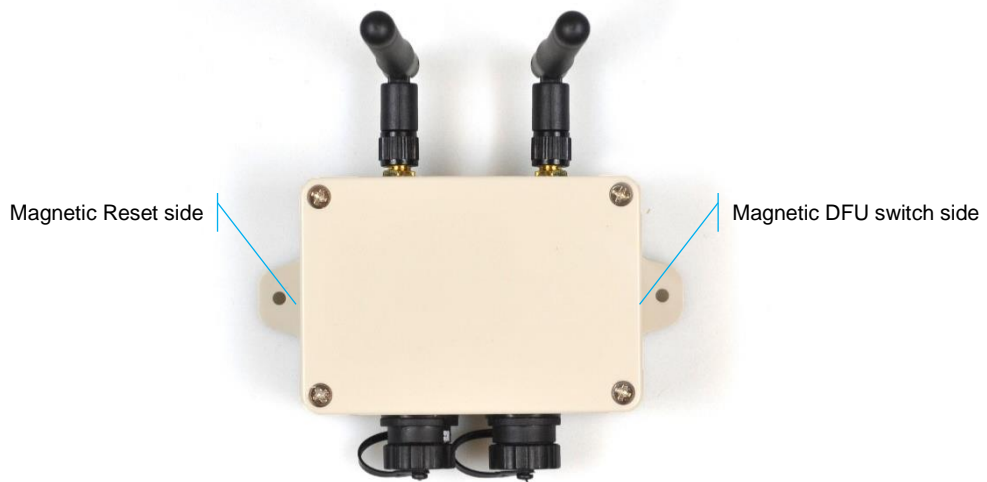

5.2.3.2. DFU Programming process:

1. Enter device into DFU Mode:
 - For regular and non-Industrial versions of beacons – switch DIP switches into positions shown on the picture (both up) and press the Reset button – device will go into DFU mode
 - For Industrial versions of beacon and Super-Modem – attach one magnet to the DFU switch side, and attach for 1 second the second magnet to the Reset side of the device – device will go into DFU mode (Do not forget to power Industrial versions of beacon and Super-Modem – they do not have internal battery)
 - For Modem HW v5.1 and Modem HW v4.9 – short DFU mode pins and press the Reset button – device will go into DFU mode
2. Connect the device via USB to your PC (Do not forget to power Industrial versions of beacon and Super-Modem – they do not have internal battery).
- Run DfuSe (Choose whichever works the best for your Windows: [DfuSe v3.0.4](#) or [DfuSe v.3.0.5.](#), [DfuSe v3.0.6](#))
3. In the upper left corner of the DfuSe program, you will see a device connected in the DFU mode (If not – reenter device into DFU mode).
4. Choose the DFU driver (file) for the beacon.

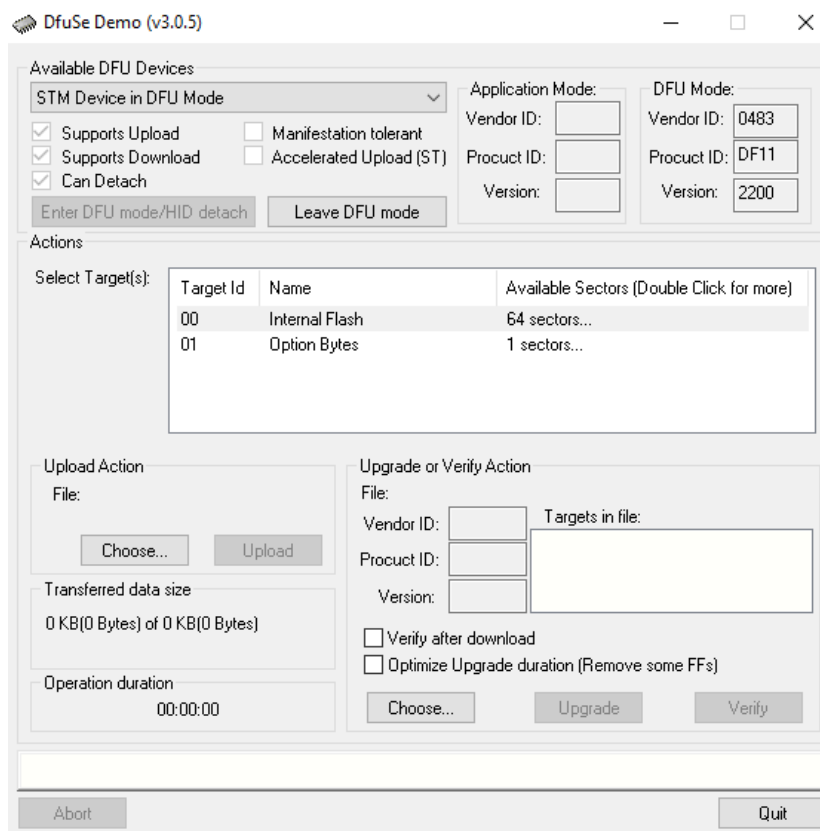

5. Click the **UPGRADE** button.
6. After a couple of seconds, the DFU will be uploaded to the beacon. Make sure it takes 1–3 seconds and does not happen instantly. Otherwise, the SW has not been uploaded correctly. If the DFU appears to upload immediately, check the "Choose" button you used or change the version of DfuSe SW you selected.

7. Exit from the DFU mode:
 - For regular and non-Industrial versions of beacons – switch DIP switches into positions shown on the picture (Left – down, right – up) and press the Reset button – device will exit from DFU mode
 - For Industrial versions of beacon and Super-Modem – remove one from the DFU switch side, and attach for 1 second the second magnet to the Reset side of the device – device will exit from DFU mode
 - For Modem HW v5.1 and Modem HW v4.9 – short circuit DFU mode pins and press the Reset button – device will go into DFU mode
8. Start the Dashboard, left device connected to the PC via USB (**Do not forget to power Industrial versions of beacon and Super-Modem – they do not have internal battery**), device should appear in the Dashboard.
9. Check SW on the beacon afterwards.
10. Everything should be OK with SW now. DFU programming is complete.

5.2.3.3. DFU troubleshooting

If you experience difficulties in DFU programming, please try the following:

- Change USB cable
- Install a different DfuSe version (whichever works best with your Windows). Here you will find different versions of DfuSe: [DfuSe v3.0.4](#), [DfuSe v3.0.5](#) or [DfuSe v3.0.6](#)
- Use a different computer with a different version of Windows or another operating system



6. Setting up the system

6.1. Introduction

Our system supports [Non-Inverse Architecture and Inverse Architecture](#). But we strongly recommend to start from NIA in 2D configuration (2 stationary beacons and 1 mobile beacon). As you achieved perfect results in NIA, you can set up the system in IA.

Check:



[8 basic steps from unpacking to autonomous drive/flight](#)



[Step-by-step guide on how to build complex maps](#)

Detailed explanation of complex map building:

[Building submaps: Part 1](#)

[Building submaps: Part 2](#)

6.2. DIP switch positions

This chapter shows different DIP switchers positions of devices on the example of a Super-Beacon.

6.2.1. DIP switch position for OFF beacon

When DIP switch in this position – only charge of device is possible.

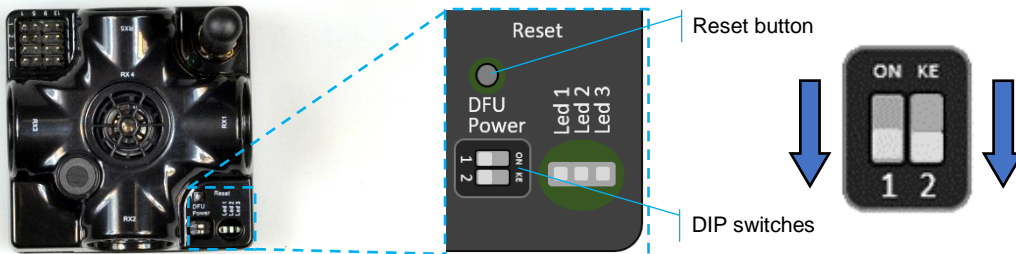

6.2.2. DIP switch position for work and HEX programming

Put DIP switch to this position:

- To turn on the beacon
- For HEX programming (via Dashboard)

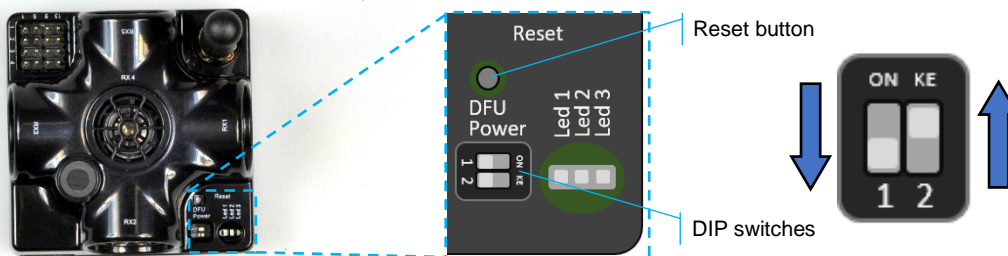

6.2.3. DIP switch position for DFU programming

Put DIP switch to this position:

- For DFU programming (via: [DfuSe v3.0.5](#) or [DfuSe v3.0.6](#))

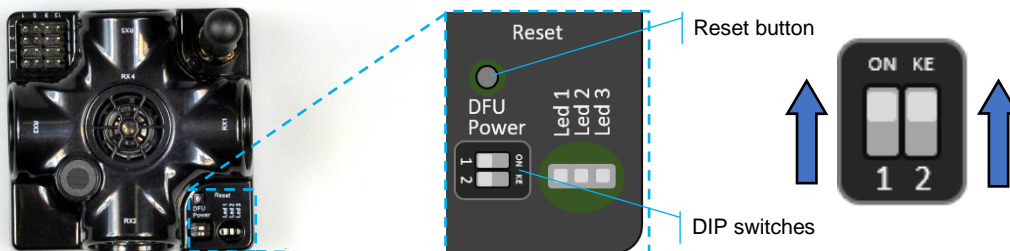

Put DIP switch to position for work and restart beacon after DFU programming.

6.3. Starter Set Super-MP-3D (NIA and IA)

The steps below describe the very first time you set up the system in NIA.

[Super-Beacons](#) and [Modem HW v5.1](#) required.



This Set can be used in IA and NIA. Use NIA Software for Non-Inverse Architecture and IA Software for Inverse Architecture.



6.3.1. Unpack the system. Look at a similar unpacking video of HW v4.9. The videos have certain differences but the basics are the same: [Unpacking Marvelmind Precise \(+-2cm\) Indoor "GPS"](#)

6.3.2. Charge all the beacons using USB cable. Full charging takes about 1-2 hours

6.3.3. Turn the beacons on: Place DIP switches as shown on the picture below

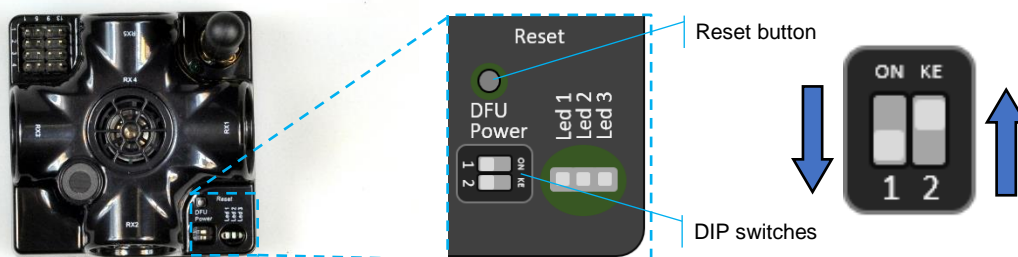

6.3.4. Download SW Pack

6.3.5. Update all the beacons (HEX programming):

6.3.6. Run the Dashboard and update the SW for all beacons and modem using Dashboard => Firmware => Choose the file => Program

6.3.7. If you see the message "Not found modem connection to computer through USB" in the Dashboard or your PC does not recognize beacons/modem, it usually means that the STM32 driver is not installed. To install the driver, download it with link at top window in the Dashboard and run the installation file, then click on the link under and install the driver

6.3.8. Ensure that:

6.3.9. You are programming the modem's SW to the modem and the beacon's SW to the beacon

6.3.10. You are using SW for Super-beacon, if you have Super-beacon; and you have the SW from the same SW pack, i.e., the Dashboard SW, modem SW, and beacon SW must be from the same SW pack. Don't mix SW releases



6.3.11. If SW flashed **SUCCESSFULLY, MOVE DIRECTLY TO 6.3.13.** If you have some problems with HEX programming, use DFU programming:

6.3.11.1. DFU programming or SW uploading is used when HEX SW uploading in the Dashboard cannot be used. For example, when you are updating from a very old SW version or when the SW includes major changes to the system and the only possible way to update the SW is via DFU programming

6.3.11.2. After the DFU SW upgrade, future SW upgrades can be done in a regular manner via the Dashboard

6.3.11.3. To start programming, move the beacon's DIP switch to the DFU programming mode, as described in the paragraph on [DIP switch modes](#)



6.3.11.4. Download the latest [SW package](#), unzip it, and select the proper version of the SW for your HW and for your frequency variant. Remember that for DFU programming, you should use DFU SW (DfuSe), not Dashboard's .hex file



6.3.11.5. Download DfuSe

6.3.11.6. Here you will find different versions of DfuSe. v3.0.5 or v3.0.6, whichever works the best for your Windows: [DfuSe v3.0.5](#) or [DfuSe v3.0.6](#)



6.3.11.7. DFU Programming:

6.3.11.8. Put DIP switch into **Power = ON, DFU = ON**



6.3.11.9. Connect the beacon via USB to your PC

6.3.11.10. Run DfuSe

6.3.11.11. Press the RESET button on your beacon

6.3.11.12. In the upper left corner of the DfuSe program, you will see a device connected in the DFU mode

6.3.11.13. Choose the DFU driver (file) for the beacon

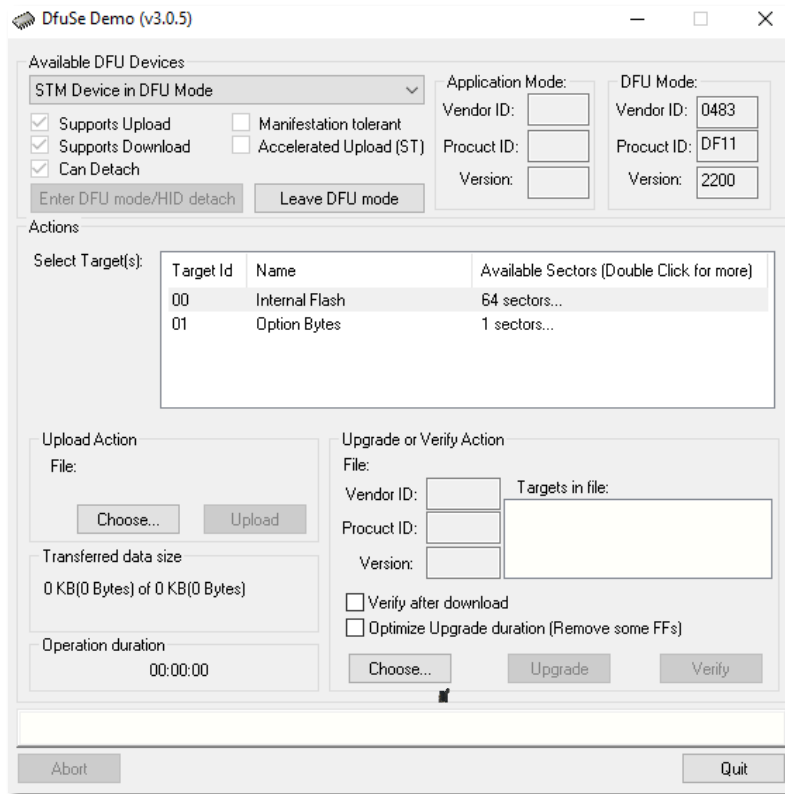

6.3.11.14. Click the **UPGRADE** button

6.3.11.15. After a couple of seconds, the DFU will be uploaded to the beacon. Make sure it takes 1–3 seconds and does not happen instantly. Otherwise, the SW has not been uploaded correctly. If the DFU appears to upload immediately, check the "Choose" button you used or change the version of DfuSe SW you selected

6.3.11.16. Move the DIP switch into **Power = ON, DFU = OFF**

6.3.11.17. Start the Dashboard and press the **RESET** button on the beacon

6.3.11.18. Check SW on the beacon afterwards

6.3.11.19. Everything should be OK with SW now. DFU programming is complete

6.3.11.20. Follow the same scenario for the modem:

6.3.11.21. After uploading DFU driver by DfuSe short circuit pins as shown on the picture (for v4.9) and press **Reset** button

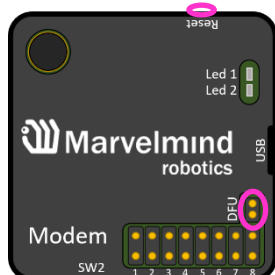

6.3.11.22. Modem will go to DFU mode. Press **UPGRADE** button in the DfuSe program

- 6.3.11.23. After a couple of seconds, the DFU will be uploaded to the modem. Make sure it takes 1-3 seconds and does not happen immediately. Otherwise, the SW has not been uploaded correctly. If the DFU appears to upload immediately, check the "Choose" button you used or change the version of DfuSe SW to a different one
- 6.3.11.24. Disconnect the short circuit
- 6.3.11.25. Start the Dashboard and press **RESET** button
- 6.3.12. If you experience difficulties in DFU programming, please try the following:
- 6.3.12.1. Use a different computer with a different version of Windows or another operating system
- 6.3.12.2. Install a different DfuSe version (whichever works best with your Windows)
- 6.3.13. If you have uploaded the latest firmware for all the boards, you can start to activate the system:
- 6.3.14. While the beacon or modem is connected to the Dashboard, click the **DEFAULT** button on the Dashboard to upload the default settings. **Do it after each SW upgrade for all devices!**

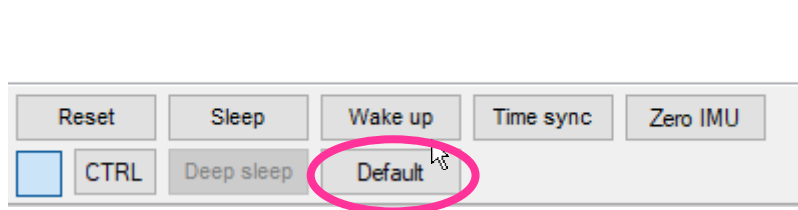

- 6.3.15. Write down the beacon's address for future use or change the address at your convenience. Enter device address and press ENTER, after - press write changes button. Beacons' addresses should not be repeated.

<input type="button" value="Read all"/> <input type="button" value="Write all"/> <input type="button" value="Write changes"/> <input type="button" value="Cancel changes"/>	
CPU ID	02325A
Firmware version	v7.044 Super-Beacon
Power save functions	enabled / active
Hedgehog mode	disabled
Supply voltage, V (3.5..4.2)	3.71
Time from reset, h:m:s	00:22:13 / 14.55.57 / 0
RSSI from modem, dBm	-53
RSSI to modem, dBm	-56
Profile	General
Radio frequency band	"915 MHz"
Carrier frequency, MHz	919.0
Radio channel	0
Device address (1..254)	11
Height, m (-320.000..320.000) in submap 0	0.000
Measured temperature, °C	23
Ultrasonic frequency, Hz (100..65000)	31000
Desired speed, % (0..100)	n/a
IMU	(+) expand
Parameters of radio	(+) expand
Ultrasound	(+) expand
Interfaces	(+) expand
Misc. settings	(+) expand
Hedgehogs pairing	(+) expand
Real-time player	disabled
Real-time player backward (0..127)	3
Real-time player forward (0..127)	5

6.3.16. Choose one of the beacons and enable “Hedgehog mode”

CPU ID	Copy to clipboard	08421E
Firmware version		v7.400i Super-Beacon-2
Power save functions		enabled / active
Hedgehog mode		enabled
Supply voltage, V (3.50..4.35)		4.00
Time from reset, h:m:s		00:02:55 / 19.20.54 / 0
RSSI from modem, dBm		-81
RSSI to modem, dBm		n/a
Profile		General (915 MHz band)
Carrier frequency, MHz		919.0
Radio channel		0
Device address (1..254)		104
Height, m (-320.000..320.000)		0.000
Measured temperature, °C		23
Ultrasonic frequency, Hz (100..65000)		45000
Advanced settings		(+) expand
IMU		(+) expand
Parameters of radio		(+) expand
Ultrasound		(+) expand
Interfaces		(+) expand
Georeferencing		(+) expand
Misc. settings		(+) expand
Hedgehogs pairing		(+) expand
Real-time player streaming		disabled
Real-time player for gaps		disabled
Real-time player backward (0..127)		3
Real-time player forward (0..127)		5

6.3.17. Press the RESET button on your beacons and modem after programming

6.3.18. After programming devices with the latest software, the modem and beacons are ready for use

6.3.19. Place the stationary beacons high on the walls vertically in a way that will provide optimal ultrasonic coverage. Write down the beacon's height for future change in the settings. The help video on installation can be found here - [Help: how to place beacons](#)

Side view of 2D configuration:

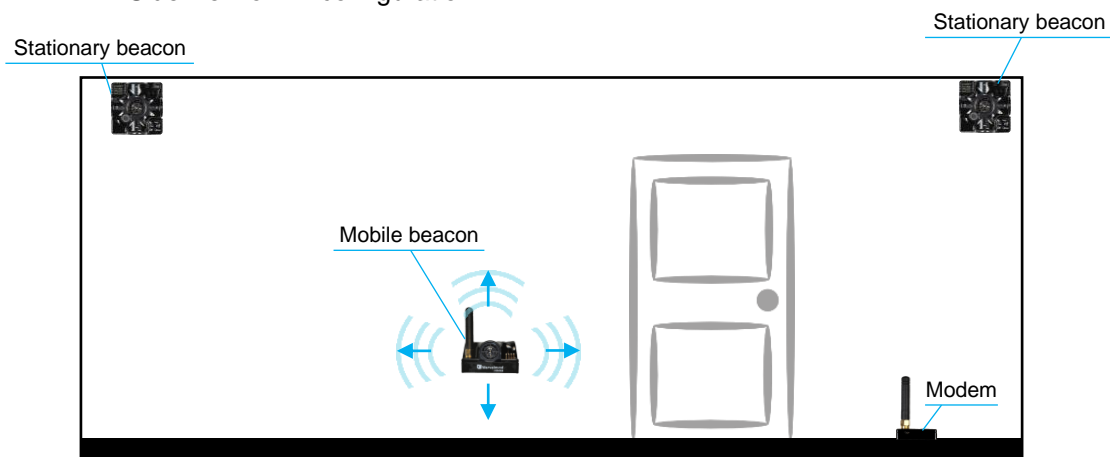

Top view of 2D configuration:

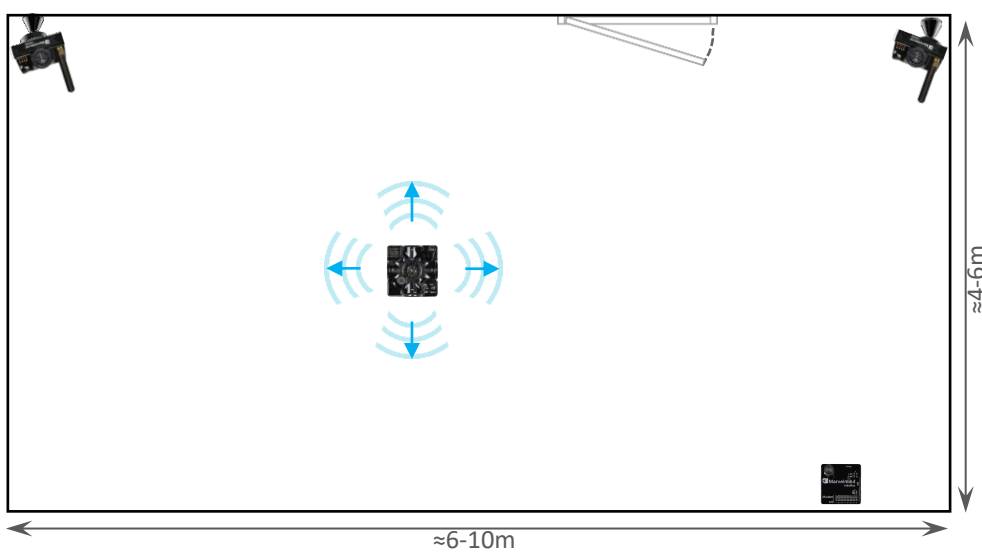

More information about placement you can find in [Placement Manual](#)



- 6.3.20. Connect the modem/router via USB to a Windows PC with the Dashboard installed
- 6.3.21. Run the Dashboard. In the left corner of the Dashboard, the modem should be shown as connected
- 6.3.22. Wake up all beacons by selecting them on the Dashboard panel



Only 4 stationary beacons may be in 1 submap. If you wake up more beacons, create new submap for them or it won't be displayed on the map and in the table of distances.

- 6.3.23. It may take up to 7-10 seconds for the beacons to wake up
- 6.3.24. Notice, that if the modem is not active and is not powered, the beacons will go into sleep mode automatically after 1 minute
- 6.3.25. The system may run the frequency search, if it is the very first time you are waking up the beacons. If this step does not work, disconnect the modem and connect that beacon again via USB. Press the DEFAULT button in the Dashboard and the Read All button to make sure that the radio settings are the default ones
- 6.3.26. Check that the radio settings on the modem and the radio settings on the beacon are the same
- 6.3.27. Now you can check RSSI, voltage, ultrasonic filter settings, etc. on the panel on the right corner of the Dashboard

Supply voltage, V	3.95
Desired speed, % (0..100)	30
Height, m (-320.000..320.000)	0.000
Time from reset, h:m:s	00:01:26 R
Measured temperature, °C	23
RSSI, dBm	-28
Radio frequency band	915 MHz
Carrier frequency, MHz	919.000
Device address (0..254)	30
Radio channel	0
Ultrasonic frequency, Hz (100..65000)	25000
Filter selection	31 kHz

6.3.28. Enter the height of stationary beacons. Choose beacon in the list and enter height value

Read all		Write all	
CPU ID	Copy to clipboard	013326	
Firmware version		V6.192 Super-Beacon	
Power save functions		enabled	
Hedgehog mode		enabled	
Inverse system		disabled	
Distances only mode		disabled	
Supply voltage, V		3.95	
Desired speed, % (0..100)		30	
Height, m (-320.000..320.000)		0.000	
Time from reset, h:m:s		00:01:26 R	
Measured temperature, °C		23	
RSSI, dBm		-28	
Radio frequency band		915 MHz	
Carrier frequency, MHz		919.000	
Device address (0..254)		30	
Radio channel		0	
Ultrasonic frequency, Hz (100..65000)		25000	
Filter selection		31 kHz	



Enter the height for mobile beacon if you are using 2D mode

6.3.29. In the current version one modem supports 250 beacons (mobile + stationary combined). If you do not see some of your connected beacons on the map, you may need to scroll to find their addresses

6.3.30. **Double click on the device both to put it into sleep mode and to wake it up**

<input type="checkbox"/>	Device1	<input checked="" type="checkbox"/>	Beacon2-d	<input checked="" type="checkbox"/>	Beacon3-d	<input checked="" type="checkbox"/>	Device4
<input type="checkbox"/>	Device14	<input type="checkbox"/>	Device15	<input type="checkbox"/>	Device16	<input type="checkbox"/>	Device17

6.3.31. The map will form and zoom in automatically

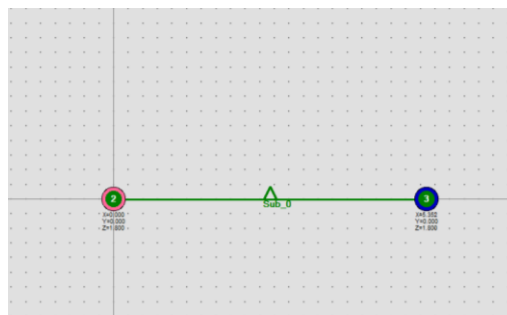

6.3.32. If the map does not form well, check the table of distances in the left corner of the Dashboard. The cells must be colored in white; it means the distances between stationary beacons are measured correctly

P01	2	3
2		5.374
3	5.330	

6.3.33. If you see in the table some empty cells or marked yellow/red, it is an indication that distances between Some beacons are measured inconsistently or not measured at all. Try to re-position them because usually there is an obstruction of some sort in the between the beacons. If you have any problems – check [Table of distances](#) chapter

6.3.34. Make a service zone, clicking on the map with **Shift + Left click**. See [Submaps chapter](#) for more details

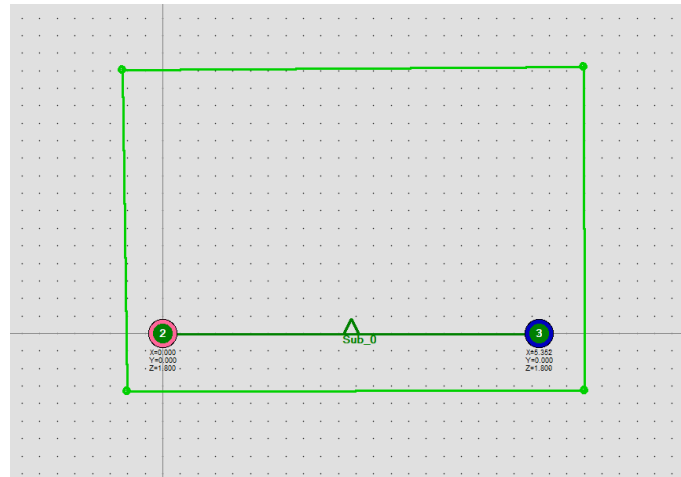

6.3.35. Freeze the Submap by clicking the button. Stationary beacons will stop measuring relative distances and will be ready to measure distance from the mobile beacon(s)

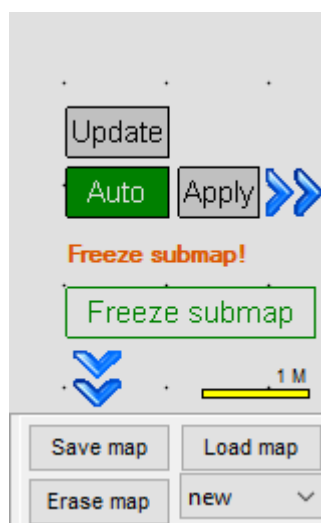



6.3.36. Turn on and wake up the mobile beacon following the same steps as with the stationary beacon. More details in our video: <https://youtu.be/A4aRsjH2-E>

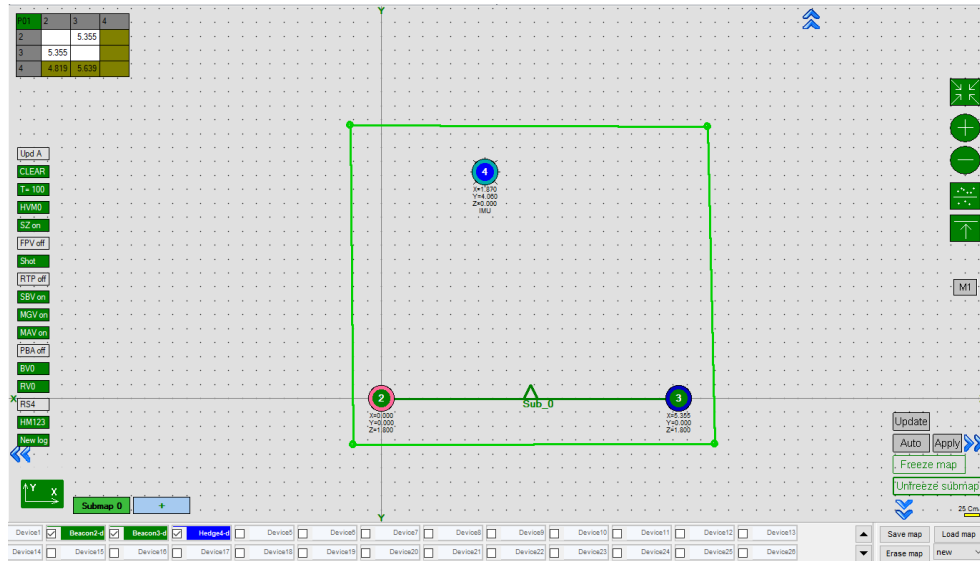

6.3.37. If you see on the devices' panel in the Dashboard that the beacon is colored orange, it means there are some differences in some of the settings between beacons. For example, some sensors may be off or some ultrasonic or radio settings may be different. You can change the settings for sensors manually by clicking on the panel on the upper right corner of the Dashboard to change the cells from gray to green to turn on sensor. It is recommended that the default settings on all beacons and the modem are used if this is your first time using the system.

6.3.38. If all looks good and table of distance still colored white, freeze the map.

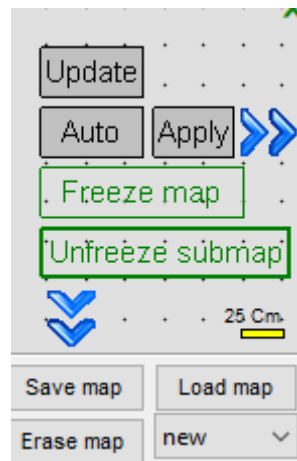

6.3.39. The system is now fully operational.

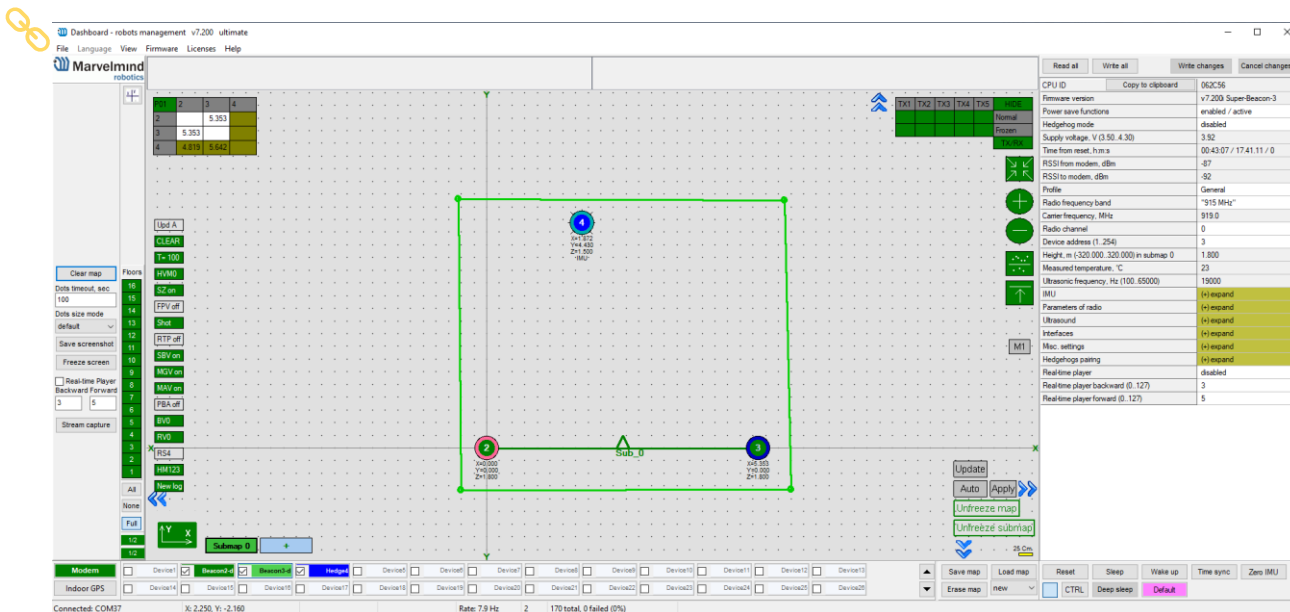

6.3.40. In the Dashboard, you can upload a picture / map of your room. You can use a different picture for every floor. Go to [Loading the floorplan](https://www.youtube.com/watch?v=NHUnCtJIYXc) (Help video: <https://www.youtube.com/watch?v=NHUnCtJIYXc>)



6.4. Starter Set HW v4.9

The steps below describe the very first time you set up of the system in NIA. [Beacons HW v4.9](#) with the same frequencies and [Modem HW v4.9](#) required.



This is Non-Inverse Architecture. Use NIA Software ONLY



6.4.1. Unpack the system. Watch the help video: https://youtu.be/sOce7B2_6Sk

6.4.2. Charge all the beacons using USB cable. Full charging takes about 1-2 hours

6.4.3. Turn the beacons on: Place DIP switches as shown on the picture below

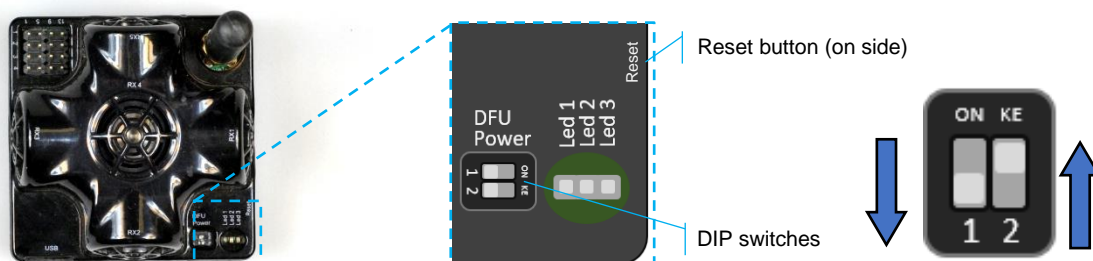

6.4.4. Download [SW Pack](#)

6.4.5. Update all the beacons (HEX programming):

- Run the Dashboard and update the SW for all beacons and modem using Dashboard => Firmware => Choose the file => Program
- If you see the message "Not found modem connection to computer through USB" in the Dashboard or your PC does not recognize beacons/modem, it usually means that the STM32 driver is not installed. To install the driver, download it with link at top window in the Dashboard and run the installation file, then click on the link under and install the driver

Ensure that:

- You are programming the modem's SW to the modem and the beacon's SW to the beacon
- You are using SW for HW v4.9, if you have HW v4.9; and you have the SW from the same SW pack, i.e., the Dashboard SW, modem SW, and beacon SW must be from the same SW pack. Don't mix SW releases



If SW flashed SUCCESSFULLY, MOVE DIRECTLY TO 4.2.6. If you have some problems with HEX programming, use DFU programming:

DFU programming or SW uploading is used when HEX SW uploading in the Dashboard cannot be used. For example, when you are updating from a very old SW version or when the SW includes major changes to the system and the only possible way to update the SW is via DFU programming

- 6.4.5.1. After the DFU SW upgrade, future SW upgrades can be done in a regular manner via the Dashboard
- 6.4.5.2. To start programming, move the beacon's DIP switch to the DFU programming mode, as described in the paragraph on [DIP switch modes](#)
- 6.4.5.3. Download the latest [SW package](#), unzip it, and select the proper version of the SW for your HW and for your frequency variant. Remember that for DFU programming, you should use DFU SW (DfuSe), not Dashboard's .hex file
- 6.4.5.4. Download DfuSe
- 6.4.5.5. Here you will find different versions of DfuSe. v3.0.5 or v3.0.6, whichever works the best for your Windows: [DfuSe v3.0.5](#) or [DfuSe v3.0.6](#)
- 6.4.5.6. DFU Programming:
- 6.4.5.7. Put DIP switch into **Power = ON, DFU = ON**
- 6.4.5.8. Connect the beacon via USB to your PC
- 6.4.5.9. Run DfuSe
- 6.4.5.10. Press the **RESET** button on your beacon
- 6.4.5.11. In the upper left corner of the DfuSe program, you will see a device connected in the DFU mode



6.4.5.12. Choose the DFU driver (file) for the beacon

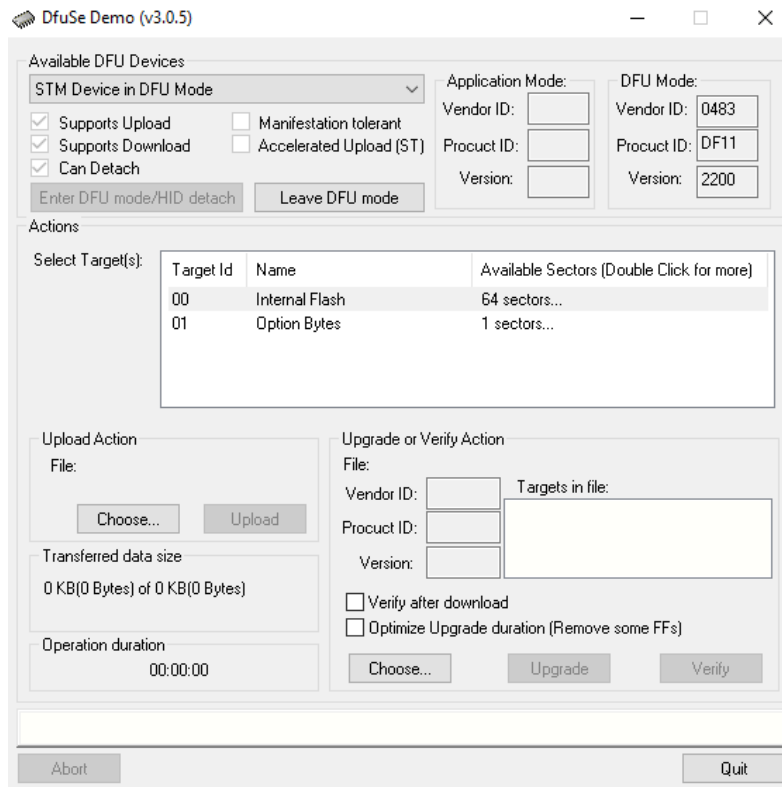

6.4.5.13. Click the **UPGRADE** button

6.4.5.14. After a couple of seconds, the DFU will be uploaded to the beacon. Make sure it takes 1–3 seconds and does not happen instantly. Otherwise, the SW has not been uploaded correctly. If the DFU appears to upload immediately, check the "Choose" button you used or change the version of DfuSe SW you selected

6.4.5.15. Move the DIP switch into **Power = ON, DFU = OFF**

6.4.5.16. Start the Dashboard and press the **RESET** button on the beacon

6.4.5.17. Check SW on the beacon afterwards

6.4.5.18. Everything should be OK with SW now. DFU programming is complete

6.4.5.19. Follow the same scenario for the modem:



6.4.5.20. Here is the [link](#) for the modem DFU programming. The steps are similar to those for beacon DFU programming

6.4.5.21. After uploading DFU driver by DfuSe short circuit pins as shown on the picture (for v4.9) and press **Reset** button

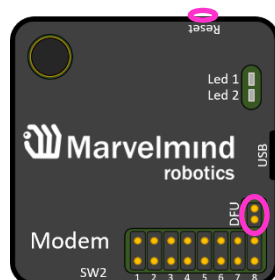

- 6.4.5.22. Modem will go to DFU mode. Press **UPGRADE** button in the DfuSe program
- 6.4.5.23. After a couple of seconds, the DFU will be uploaded to the modem. Make sure it takes 1-3 seconds and does not happen immediately. Otherwise, the SW has not been uploaded correctly. If the DFU appears to upload immediately, check the "Choose" button you used or change the version of DfuSe SW to a different one
- 6.4.5.24. Disconnect the short circuit
- 6.4.5.25. Start the Dashboard and press **RESET** button
- 6.4.5.26. If you experience difficulties in DFU programming, please try the following:
- 6.4.5.27. Use a different computer with a different version of Windows or another operating system
- 6.4.5.28. Install a different DfuSe version (whichever works best with your Windows)

If you have uploaded the latest firmware for all the boards, you can start to activate the system:

- 6.4.6. While the beacon or modem is connected to the Dashboard, click the **DEFAULT** button on the Dashboard to upload the default settings

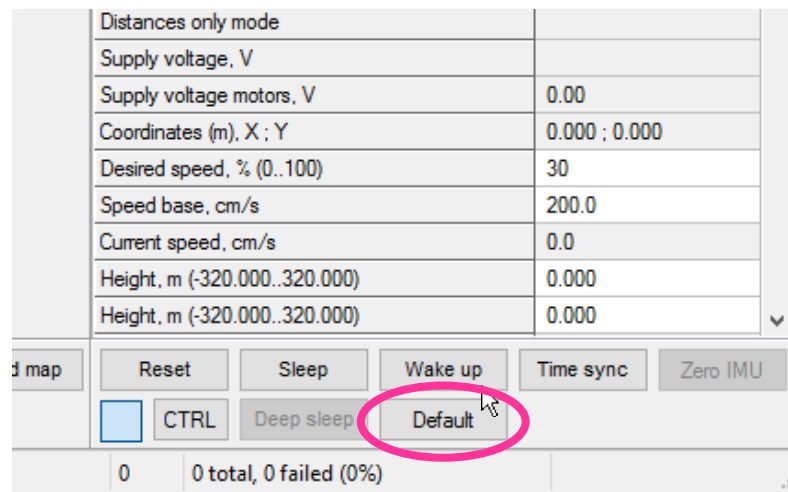

6.4.7. Write down the beacon's address for future use or change the address at your convenience as shown here. Beacons' addresses should not be repeated.

Hedgehog mode	enabled
Inverse system	enabled
Distances only mode	disabled
Supply voltage, V	3.70
Desired speed, % (0..100)	30
Time from reset, h:m:s	00:00:04 R
Measured temperature, °C	23
RSSI, dBm	-74
Radio frequency band	915 MHz
Carrier frequency, MHz	919.800
Device address (0..254)	154
Radio channel	0
Ultrasonic frequency, Hz (100..65000)	n/a
Filter selection	n/a
IMU	(+) expand
Parameters of radio	(+) expand
Ultrasound	(+) expand
Interfaces	(+) expand
Georeferencing	(+) expand
Misc. settings	(+) expand
Hedgehogs pairing	(+) expand
Real-time player	disabled
Real-time player backward (0..127)	3
Real-time player forward (0..127)	5

6.4.8. Choose one of the beacons and enable “Hedgehog mode”. Use this beacon as a mobile beacon in future

CPU ID	Copy to clipboard	08421E
Firmware version		v7.400i Super-Beacon-2
Power save functions		enabled / active
Hedgehog mode		enabled
Supply voltage, V (3.50..4.35)		4.00
Time from reset, h:m:s		00:02:55 / 19.20.54 / 0
RSSI from modem, dBm		-81
RSSI to modem, dBm		n/a
Profile		General (915 MHz band)
Carrier frequency, MHz		919.0
Radio channel		0
Device address (1..254)		104
Height, m (-320.000..320.000)		0.000
Measured temperature, °C		23
Ultrasonic frequency, Hz (100..65000)		45000
Advanced settings		(+) expand
IMU		(+) expand
Parameters of radio		(+) expand
Ultrasound		(+) expand
Interfaces		(+) expand
Georeferencing		(+) expand
Misc. settings		(+) expand
Hedgehogs pairing		(+) expand
Real-time player streaming		disabled
Real-time player for gaps		disabled
Real-time player backward (0..127)		3
Real-time player forward (0..127)		5

6.4.9. Press the RESET button on your beacons and modem after programming

6.4.10. After programming devices with the latest software, the modem and beacons are ready for use

6.4.11. Place the stationary beacons high on the walls vertically in a way that will provide optimal ultrasonic coverage. Write down the beacon's height for future change in the settings. The help video on installation can be found here - <https://youtu.be/WYOHkLzmjys>



Side view of 2D configuration:

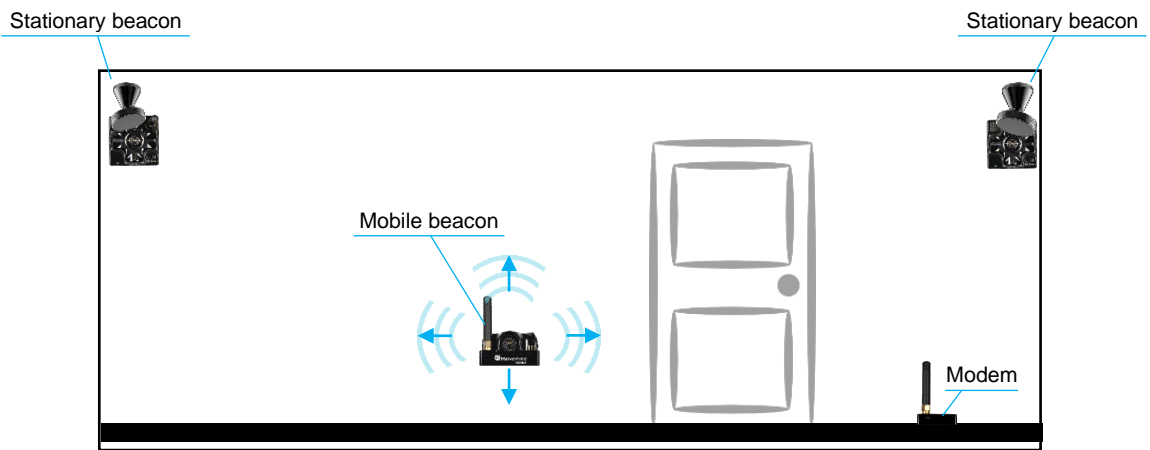

Top view of 2D configuration:

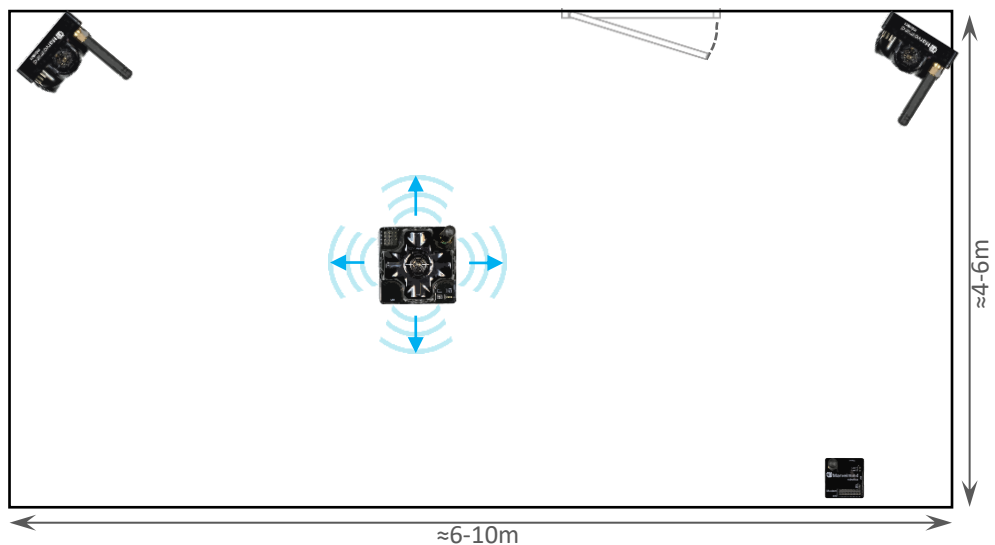

- 6.4.12. Connect the modem/router via USB to a Windows PC with the Dashboard installed
- 6.4.13. Run the Dashboard. In the left corner of the Dashboard, the modem should be shown as connected
- 6.4.14. Wake up all beacons by selecting them on the Dashboard panel



Only 4 stationary beacons may be in 1 submap. If you wake up more beacons, create a new submap for them or it won't be displayed on the map and in the table of distances

- 6.4.15. It may take up to 7-10 seconds for the beacons to wake up
- 6.4.16. Notice, that if the modem is not active and is not powered, the beacons will go into sleep mode automatically after 1 minute
- 6.4.17. The system may run the frequency search, if it is the very first time you are waking up the beacons. If this step does not work, disconnect the modem and connect that beacon again via USB. Press the DEFAULT button in the Dashboard and the Read All button to make sure that the radio settings are the default ones
- 6.4.18. Check that the radio settings on the modem and the radio settings on the beacon are the same

6.4.19. Now you can check RSSI, voltage, ultrasonic filter settings, etc. on the panel on the right corner of the Dashboard

Supply voltage, V	3.95
Desired speed, % (0..100)	30
Height, m (-320.000..320.000)	0.000
Time from reset, h:m:s	00:01:26 R
Measured temperature, °C	23
RSSI, dBm	-28
Radio frequency band	915 MHz
Carrier frequency, MHz	919.000
Device address (0..254)	30
Radio channel	0
Ultrasonic frequency, Hz (100..65000)	25000
Filter selection	31 kHz

6.4.20. Enter the height of stationary beacons. Choose beacon in the list and enter height value

Read all		Write all	
CPU ID	Copy to clipboard	013326	
Firmware version	V6.192 Super-Beacon		
Power save functions	enabled		
Hedgehog mode	enabled		
Inverse system	disabled		
Distances only mode	disabled		
Supply voltage, V	3.95		
Desired speed, % (0..100)	30		
Height, m (-320.000..320.000)	0.000		
Time from reset, h:m:s	00:01:26 R		
Measured temperature, °C	23		
RSSI, dBm	-28		
Radio frequency band	915 MHz		
Carrier frequency, MHz	919.000		
Device address (0..254)	30		
Radio channel	0		
Ultrasonic frequency, Hz (100..65000)	25000		
Filter selection	31 kHz		



Enter the height for mobile beacon if you use 2D mode

6.4.21. In the current version one modem supports 250 beacons (mobile + stationary combined). If you do not see some of your connected beacons on the map, you may need to scroll to find their addresses

6.4.22. Double click on the device both to put it into sleep mode and to wake it up

6.4.23. The map will form and zoom in automatically

6.4.24. If the map does not form well, check the table of distances in the left corner of the Dashboard. The cells must be colored in white; it means the distances between stationary beacons are measured correctly

Dashboard - robots management v7.048 ultimate

File Language View Firmware Licenses Help

Marvelmind robotics

P01	10	11	12	13
9	6.946	8.133	16.240	3.062
10		7.862	10.703	9.448
11	7.862		9.525	10.763
12	10.703	9.525		3.205
13	9.448	10.763	3.205	

Clear map

- 6.4.25. If you see in the table some empty cells or marked yellow/red, it is an indication that distances between Some beacons are measured inconsistently or not measured at all. Try to re-position them because usually there is an obstruction of some sort in the between the beacons. If you have any problems – check Table of distances chapter
- 6.4.26. Make a service zone, clicking on the map with Shift + Left Click. See Submaps chapter for more details
- 6.4.27. Freeze the map by clicking the button. Stationary beacons will stop measuring relative distances and will be ready to measure distance from the mobile beacon(s)
- 6.4.28. Turn on and wake up the mobile beacon following the same steps as with the stationary beacon. More details in our video: [Demo: converting beacon to mobile beacon \("hedgehog"\)](#)
- 6.4.29. If you see on the devices' panel in the Dashboard that the beacon is colored orange, it means there are some differences in some of the settings between beacons. For example, some sensors may be off or some ultrasonic or radio settings may be different. You can change the settings for sensors manually by clicking on the panel on the upper right corner of the Dashboard to change the cells from gray to green to turn on sensor. It is recommended that the default settings on all beacons and the modem are used if this is your first time using the system.
- 6.4.30. After you freeze the map of stationary beacons, wake up the mobile beacon. After it wakes up, it will be traceable within 5-7 seconds.

6.4.31. The system is now fully operational.

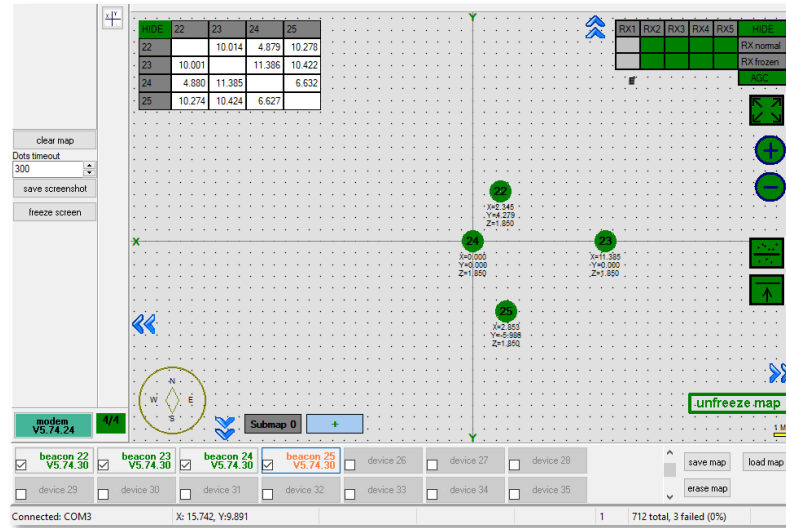

6.4.32. In the Dashboard, you can upload a picture/map of your room. You can use a different picture for every floor. Go to Loading the floorplan (Help video: <https://www.youtube.com/watch?v=NHUnCtJIYXc>)

6.5. Starter Set NIA-SmallDrone

The steps below describe the very first time you set up the system. Super-Beacon, Mini-TX beacons and modem required. Note: steps below feature the Mini-RX, which is not part of the set anymore. This will be updated later, but the process is still the same.



Super-Beacon and Mini-TX have different HW and SW from HW v4.9. Use Super-Beacon SW for Super-Beacons, Mini-TX SW for Mini-TX beacons, HW v4.9's SW for HW v4.9



6.5.1. Unpack the system. Take a look at a similar unpacking video of HW v4.9.

The videos have certain differences but the basic are the same:

https://youtu.be/sOce7B2_6Sk

6.5.2. Charge all the beacons using USB cable. Full charging takes about 1-2 hours

6.5.3. Turn the beacons on

6.5.4. Download [SW Pack](#)

6.5.5. Update all the beacons:

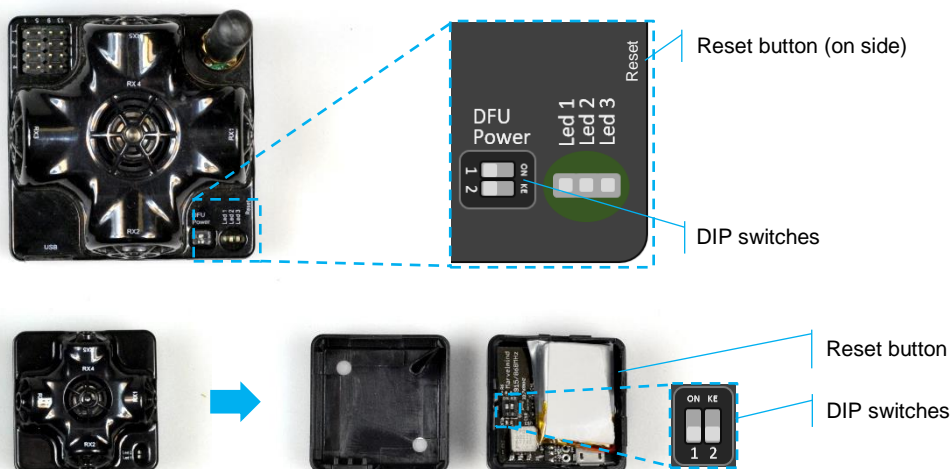

- Run the Dashboard and update the SW for all beacons and modem using **Dashboard => Firmware => Choose the file => Program**

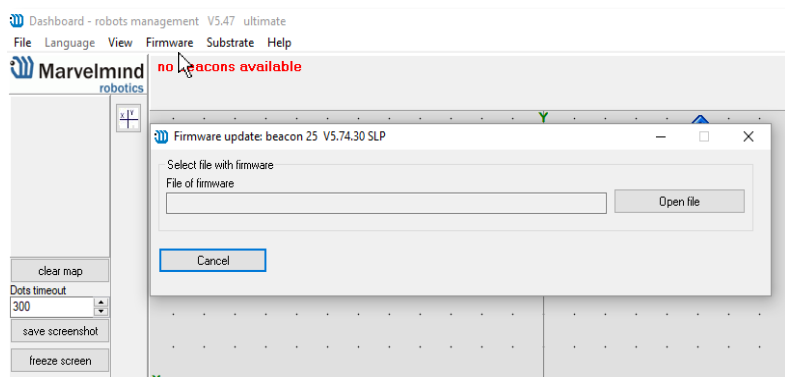

- If you see the message “Not found modem connection to computer through USB” in the Dashboard or your PC does not recognize beacons/modem, it usually means that the STM32 driver is not installed. To install the driver, download it through the link in the top window in the Dashboard and run the installation file, then click on the link under and install the driver

Make sure that that:

- You are programming the modem’s SW to the modem and the beacon’s SW to the beacon
- You are using SW for Mini-TX, if you have Mini-TX; and you have the SW from the same SW pack, i.e., the Dashboard SW, modem SW, and beacon SW must be from the same SW pack. Don’t mix SW releases



If SW flashed **SUCCESSFULLY**, **MOVE DIRECTLY TO 4.4.6**. If you have some problems with HEX programming, use DFU programming:

DFU programming or SW uploading is used when HEX SW uploading in the Dashboard cannot be used. For example, when you are updating from a very old SW version or when the SW includes major changes to the system and the only possible way to update the SW is via DFU programming

6.5.5.1. After the DFU SW upgrade, future SW upgrades can be done in a regular manner via the Dashboard

6.5.5.2. To start programming, move the beacon’s DIP switch to the DFU programming mode, as described in the paragraph on [DIP switch modes](#) (DIP switch in Mini-RX and Mini-TX situated inside the body. Carefully disassemble the body to access it, as described in paragraph [How to Flash Beacon Mini-RX](#))

6.5.5.3. Download the latest [SW package](#), unzip and select the proper version of the SW for your HW and for your frequency variant. Remember that for DFU programming, you should use DFU SW (DfuSe), not Dashboard’s .hex file

6.5.5.4. Download DfuSe

6.5.5.5. Here you will find different versions of DfuSe. v3.0.5 or v3.0.6, whichever works the best for your Windows: [DfuSe v3.0.5](#) or [DfuSe v3.0.6](#)

DFU Programming:

6.5.5.6. Put DIP switch into **Power = ON**, **DFU = ON** (DIP switch in Mini-RX and Mini-TX situated inside the body. To switch it, carefully disassemble the body)



- 6.5.5.7. Connect the beacon via USB to your PC
- 6.5.5.8. Run DfuSe
- 6.5.5.9. Press the **RESET** button on your beacon
- 6.5.5.10. In the upper left corner of the DfuSe program, you will see a device connected in the DFU mode
- 6.5.5.11. Choose the DFU driver (file) for the beacon

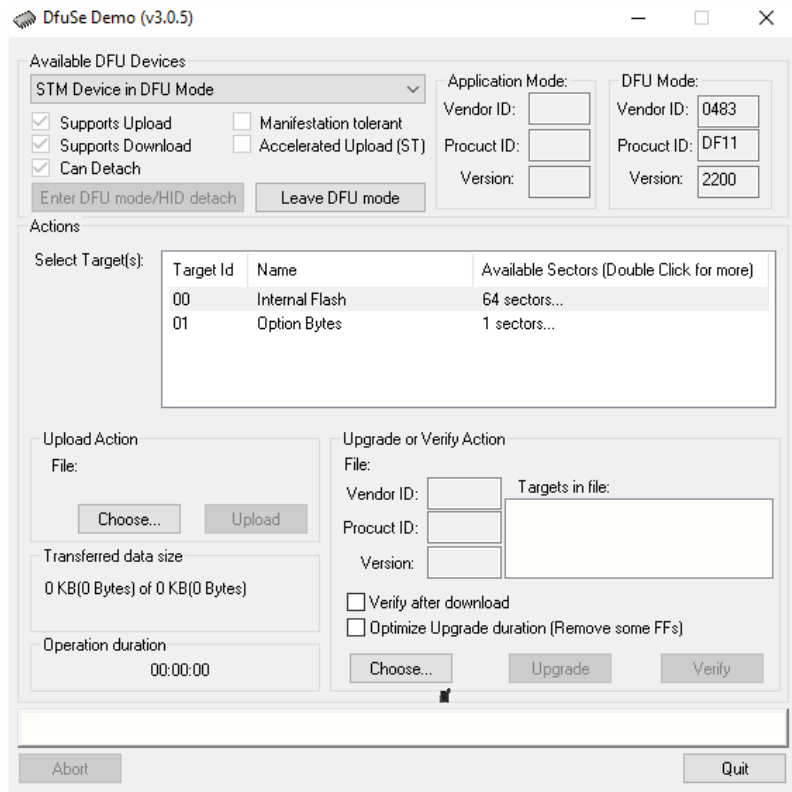

- 6.5.5.12. Click the **UPGRADE** button
- 6.5.5.13. After a couple of seconds, the DFU will be uploaded to the beacon. Make sure it takes 1–3 seconds and does not happen instantly. Otherwise, the SW has not been uploaded correctly. If the DFU appears to upload immediately, check the "Choose" button you used or change the version of DfuSe SW you selected



- 6.5.5.14. Move the DIP switch into **Power = ON, DFU = OFF**
- 6.5.5.15. Start the Dashboard and press the **RESET** button on the beacon
- 6.5.5.16. Check SW on the beacon afterwards
- 6.5.5.17. Everything should be OK with SW now. DFU programming is complete

Follow the same scenario for the modem:

- Here is the [link](#) for the modem DFU programming. The steps are similar to those for beacon DFU programming



- 6.5.5.18. After uploading DFU driver by DfuSe short circuit pins as shown on the picture and press **Reset** button

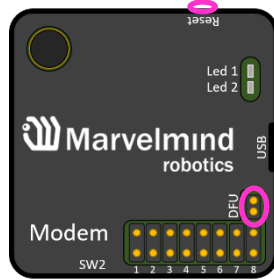

- 6.5.5.19. Modem will go to DFU mode. Press **UPGRADE** button in the DfuSe program
- 6.5.5.20. After a couple of seconds, the DFU will be uploaded to the modem. Make sure it takes 1-3 seconds and does not happen instantly. Otherwise, the SW has not been uploaded correctly. If the DFU appears to upload immediately, check the "Choose" button you used or change the version of DfuSe SW to a different one
- 6.5.5.21. Disconnect the short circuit
- 6.5.5.22. Start the Dashboard and press **RESET** button

If you have uploaded the latest firmware for all of the boards, you can start to activate the system:

- 6.5.6. While the beacon or modem is connected to the Dashboard, click the **DEFAULT** button on the Dashboard to upload the default settings
- 6.5.7. Write down the beacon's address for future use or change the address at your convenience as shown here

neogenog mode	enabled
Inverse system	enabled
Distances only mode	disabled
Supply voltage, V	3.70
Desired speed, % (0..100)	30
Time from reset, h:m:s	00:00:04 R
Measured temperature, °C	23
RSSI, dBm	-74
Radio frequency band	915 MHz
Carrier frequency, MHz	919.000
Device address (0..254)	154
Radio channel	0
Ultrasonic frequency, Hz (100..65000)	n/a
Filter selection	n/a
IMU	(+) expand
Parameters of radio	(+) expand
Ultrasound	(+) expand
Interfaces	(+) expand
Georeferencing	(+) expand
Misc. settings	(+) expand
Hedgehogs pairing	(+) expand
Real-time player	disabled
Real-time player backward (0..127)	3
Real-time player forward (0..127)	5

6.5.8. Choose one of the beacons and enable “Hedgehog mode”. Use this beacon as a mobile beacon in future

CPU ID	Copy to clipboard	08421E
Firmware version		v7.400i Super-Beacon-2
Power save functions		enabled / active
Hedgehog mode		enabled
Supply voltage, V (3.50..4.35)		4.08
Time from reset, h:m:s		00:02:55 / 19.20.54 / 0
RSSI from modem, dBm		-81
RSSI to modem, dBm		n/a
Profile		General (915 MHz band)
Carrier frequency, MHz		919.0
Radio channel		0
Device address (1..254)		104
Height, m (-320.000..320.000)		0.000
Measured temperature, °C		23
Ultrasonic frequency, Hz (100..65000)		45000
Advanced settings		(+) expand
IMU		(+) expand
Parameters of radio		(+) expand
Ultrasound		(+) expand
Interfaces		(+) expand
Georeferencing		(+) expand
Misc. settings		(+) expand
Hedgehogs pairing		(+) expand
Real-time player streaming		disabled
Real-time player for gaps		disabled
Real-time player backward (0..127)		3
Real-time player forward (0..127)		5

6.5.9. Press the RESET button on your beacons and modem after programming

6.5.10. After programming devices with the latest software, the modem and beacons are ready for use

6.5.11. Place the stationary beacons high on the walls vertically in a way that will provide optimal ultrasonic coverage. Write down the beacon's height for future change in the settings. The help video on installation can be found here - <https://youtu.be/WY0HkLzmjys>



Side view:

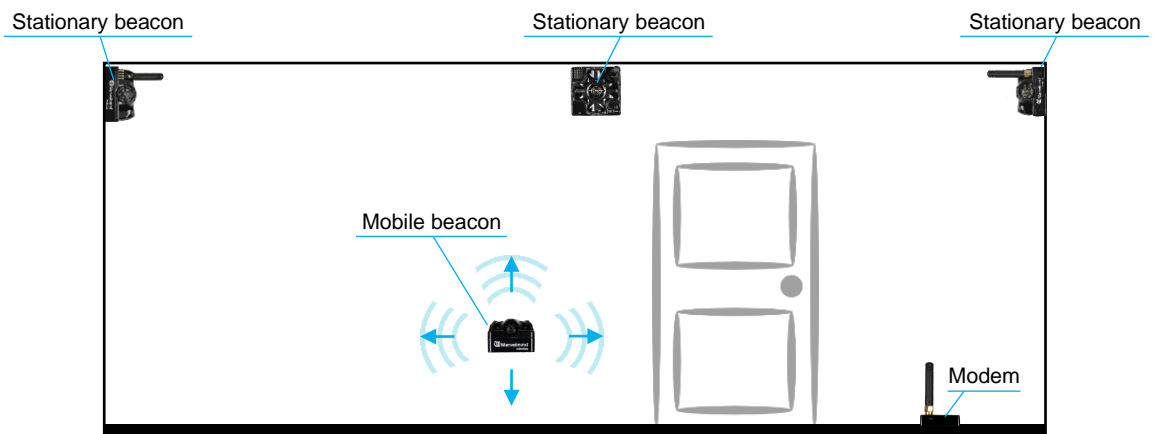

Top view:

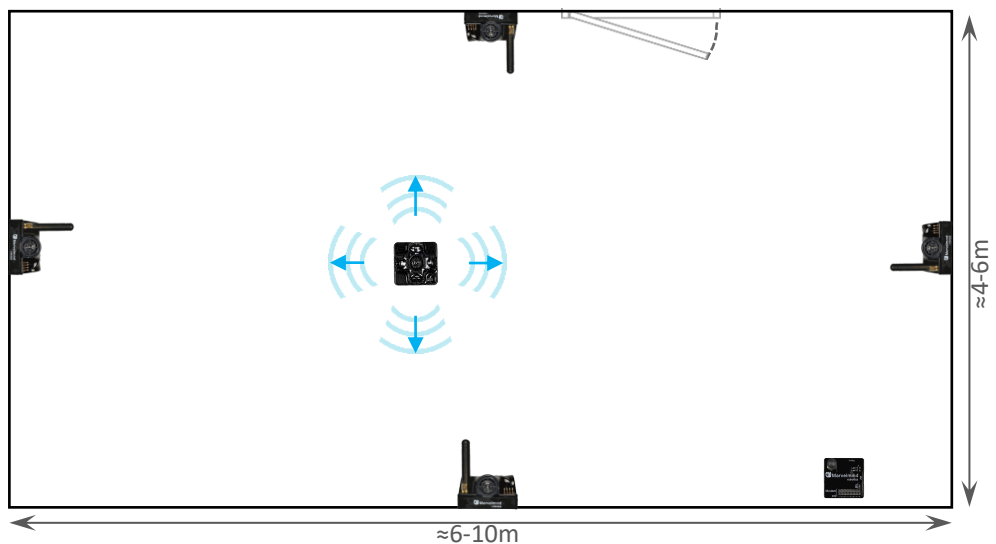

- 6.5.12. Connect the modem/router via USB to a Windows PC with the Dashboard installed
- 6.5.13. Run the Dashboard. In the left corner of the Dashboard, the modem should be shown as connected
- 6.5.14. Wake up all beacons by selecting them in the Dashboard on the panel
- 6.5.15. It may take up to 7-10 seconds for the beacons to wake up
- 6.5.16. Notice, that if the modem is not active and is not powered, the beacons will go into sleep mode automatically after 1 minute
- 6.5.17. The system may run the frequency search, if it is the very first time you are waking up the beacons. If this step does not work, disconnect the modem and connect that beacon again via USB. Press the DEFAULT button in the Dashboard and the Read All button to make sure that the radio settings are the default ones
- 6.5.18. Check that the radio settings on the modem and the radio settings on the beacon are the same
- 6.5.19. Now you can check RSSI, voltage, ultrasonic filter settings, etc. on the panel on the right corner of the Dashboard

Supply voltage, V	3.95
Desired speed, % (0..100)	30
Height, m (-320.000..320.000)	0.000
Time from reset, h:m:s	00:01:26 R
Measured temperature, °C	23
RSSI, dBm	-28
Radio frequency band	915 MHz
Carrier frequency, MHz	919.000
Device address (0..254)	30
Radio channel	0
Ultrasonic frequency, Hz (100..65000)	25000
Filter selection	31 kHz

- 6.5.20. Enter the height of stationary beacons. Choose beacon in the list and enter height value

Read all		Write all
CPU ID	Copy to clipboard	013326
Firmware version		V6.192 Super-Beacon
Power save functions		enabled
Hedgehog mode		enabled
Inverse system		disabled
Distances only mode		disabled
Supply voltage, V		3.95
Desired speed, % (0..100)		30
Height, m (-320.000..320.000)		0.000
Time from reset, h:m:s		00:01:26 R
Measured temperature, °C		23
RSSI, dBm		-28
Radio frequency band		915 MHz
Carrier frequency, MHz		919.000
Device address (0..254)		30
Radio channel		0
Ultrasonic frequency, Hz (100..65000)		25000
Filter selection		31 kHz



Enter the height for mobile beacon if you used 2D mode

6.5.21. In the current version one modem supports 250 beacons (mobile + stationary combined). If you do not see some of your connected beacons on the map, you may need to scroll to find their addresses

6.5.22. Double click on the device to put it into sleep mode or wake it up



Only 4 stationary beacons may be in 1 submap. If you wake up more beacons, create a new submap for them, otherwise it will not be displayed on the map and in the table of distances.

6.5.23. Build the map:



Mini-RX beacons cannot build the map automatically, manual inputting of the coordinates is required

- 6.5.23.1. Open the Dashboard. You will see the table of distances
- 6.5.23.2. Right click on the cell where you want to enter the distance. Additional menu will open. There you can control the table of distances. Choose **Enter distance for pair** to enter the value

HIDE	5	22	66	77
5		7.144	12.389	10.101
22	7.144		10.122	
66	12.389	10.122		
77	10.101	12.151	6.800	

Freeze distance for pair

Freeze average for pair

Don't use distance

Freeze all

Unfreeze all

Enter distance for pair

Clear cell

- 6.5.23.3. Now, enter measured (measure it with laser distance meter or so) value. That values would not change until you unfreeze or clear it. Even if beacons had been moved, distance would stay. Be careful with frozen cells because a small mistake can cause a significant impact on your tracking
- 6.5.23.4. Repeat for all cells

HIDE	6	22	66	77
6		8.000	4.200	11.400
22	8.000		13.100	6.500
66	4.200	13.100		10.800
77	11.400	6.500	10.800	

- 6.5.24. Freeze the map by clicking the button. Stationary beacons will stop measuring relative distances and will be ready to measure distance from the mobile beacon(s)

Distances only mode	
Supply voltage, V	
Supply voltage motors, V	0.00
Coordinates (m), X; Y	0.000; 0.000
Desired speed, % (0..100)	30
Speed base, cm/s	200.0
Current speed, cm/s	0.0
Height, m (-320.000..320.000)	0.000
Height, m (-320.000..320.000)	0.000

3 map

Reset Sleep Wake up Time sync Zero IMU

CTRL Deep sleep Default

0 0 total, 0 failed (0%)

- 6.5.25. Turn on and wake up the mobile beacon following the same steps as with the stationary beacon: <https://youtu.be/A4aRsjH2-E>



6.5.26. If you see on the devices' panel in the Dashboard that the beacon is colored orange, it means there are some differences in some of the settings between beacons. For example, some sensors may be off or some ultrasonic or radio settings may be different. You can change the settings for sensors manually by clicking on the panel on the upper right corner of the Dashboard to change the cells from gray to green to turn on sensor. It is recommended that the default settings on all beacons and the modem be used if this is your first time using the system.

6.5.27. After you freeze the map of stationary beacons, wake up the mobile

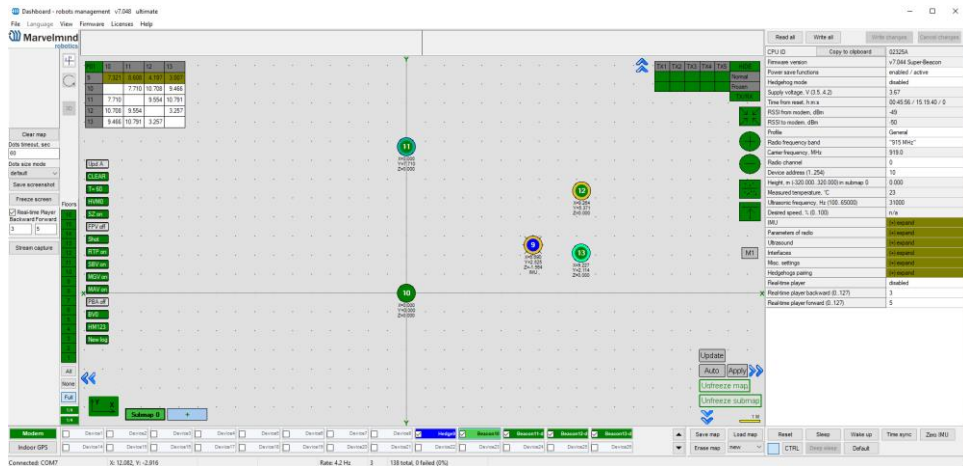

beacon. After it wakes up, it will be traceable in 5-7 seconds.

6.5.28. The system is now fully operational.

6.6. Starter Set Industrial-NIA-01

The steps below describe the first set up of the system.



This is a Non-Inverse Architecture. You can find the description and comparison of architectures [here](#).



Pay attention: Industrial beacons have different HW and SW from HW v4.9. It has different connectors, reset and DFU activation. Read more on [Industrial beacon page](#).

Industrial beacons have no battery, use power supply cable.

Use Industrial beacon's SW for Industrial beacons, v4.9 for v4.9.

Do not disassemble the Industrial beacons. Otherwise, warranty will be lost

Version 3 of Industrial RX (from April 2022) **supports ONLY +5V power supply**. Don't use +12V power supply converter for this version, it will burn the beacon!

Version 3 doesn't have UART RX, but now is possible to use Interface connector as a power supply. For this version.



6.6.1. Unpack the system. Take a look at the similar unpacking video of HW v4.9.

They are different, but have some similar basics:
https://youtu.be/sOce7B2_6Sk

6.6.2. You do not have to charge Industrial beacons; they have no battery

6.6.3. You do not have to turn it on - **Industrial beacons are permanently ON**



6.6.4. Download [SW Pack](#)

6.6.5. Update all the beacons:

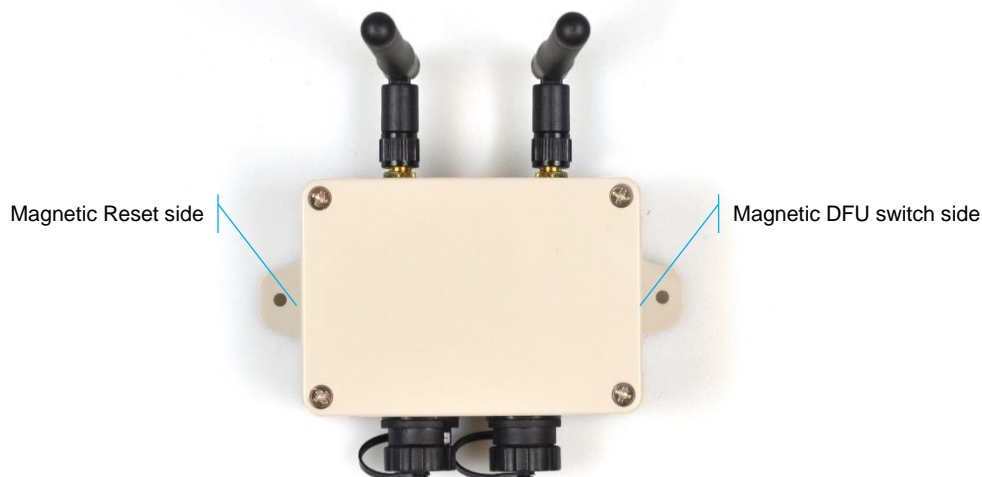



- Run the Dashboard and update the SW for all beacons and modem using **Dashboard => Firmware => Choose the file => Program**

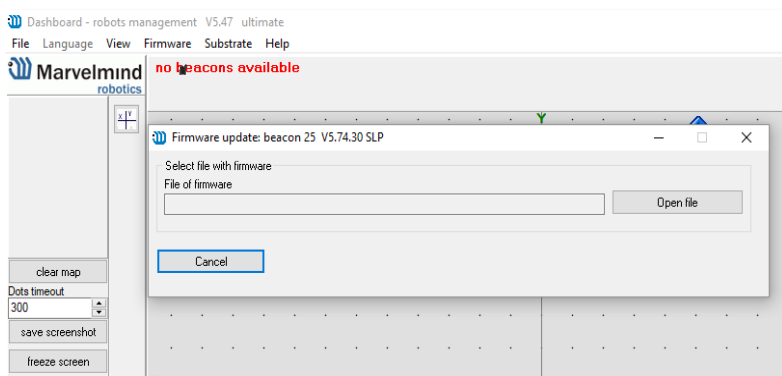

- If you see the message “Not found modem connection to computer through USB” in the Dashboard or your PC does not recognize beacons/modem, it usually means that the STM32 driver is not installed. To install the driver, download it with link at top window in the Dashboard and run the installation file, then click on the link under and install the driver

Ensure that:

- You are programming the modem’s SW to the modem and the beacon’s SW to the beacon
- You are using SW for 4.9, if you have HW v4.9; and you have the SW from the same SW pack, i.e., the Dashboard SW, modem SW, and beacon SW must be from the same SW pack. Don’t mix SW releases



If SW flashed **SUCCESSFULLY**, MOVE DIRECTLY TO 4.6.6. If you have some problems with HEX programming, use DFU programming:

DFU programming or SW uploading is used when HEX SW uploading in the Dashboard cannot be used. For example, when you are updating from a very old SW version or when the SW includes major changes to the system and the only possible way to update the SW is via DFU programming

- After the DFU SW upgrade, futures SW upgrades can be done in a regular manner via the Dashboard
- Industrial beacons have magnetic DFU mode and reset
- Download the latest [SW package](#), unzip it, and select the proper version of the SW for your HW and for your frequency variant. Remember that for DFU programming, you should use DFU SW (DfuSe), not Dashboard’s .hex file





- Download DfuSe
- Here you will find different versions of DfuSe. v3.0.5 or v3.0.6, whichever works the best for your Windows: [DfuSe v3.0.5](#) or [DfuSe v3.0.6](#)

DFU Programming:



Uploading Beacon Industrial's (Not super) DFU software to Industrial Super-Beacon hardware make permanently damage for Industrial Super-Beacon board. Be double attentive with update

- 6.6.5.1. Activate DFU mode and reset the beacon (Industrial beacons have magnetic DFU mode and reset). Place first magnet (any strong and modern magnet) to the right side of the beacon (Step 1). After that, place second magnet to the left side of the beacon and remove it in a second, just to reset it (Step 2)

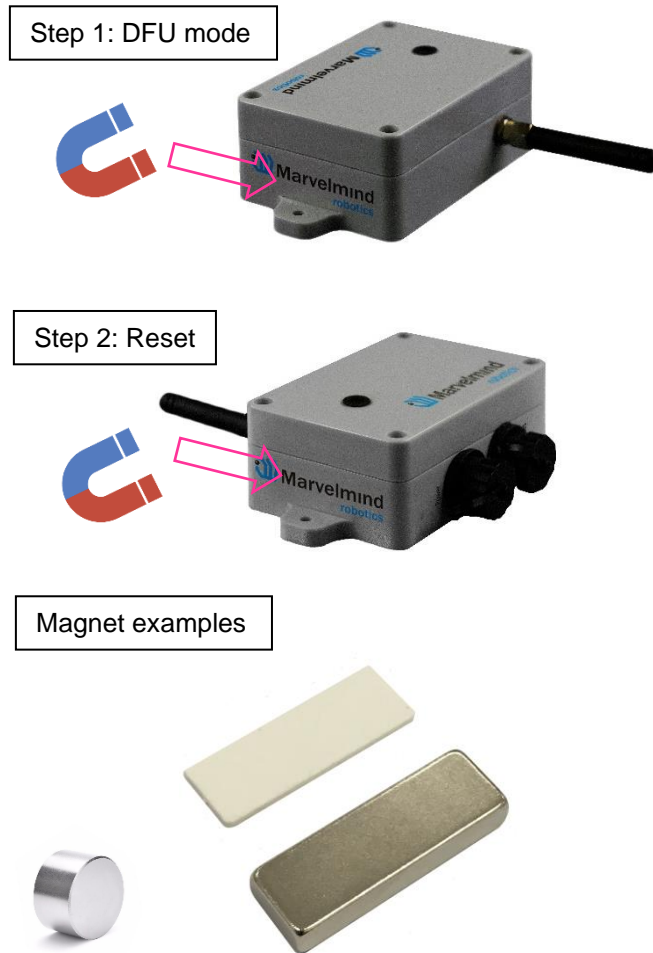

- 6.6.5.2. Connect the beacon via USB to your PC
- 6.6.5.3. Connect power supply cable to your beacon
- 6.6.5.4. Run DfuSe
- 6.6.5.5. In the upper left corner of the DfuSe program, you will see a device connected in the DFU mode

6.6.5.6. Choose the DFU driver (file) for the beacon

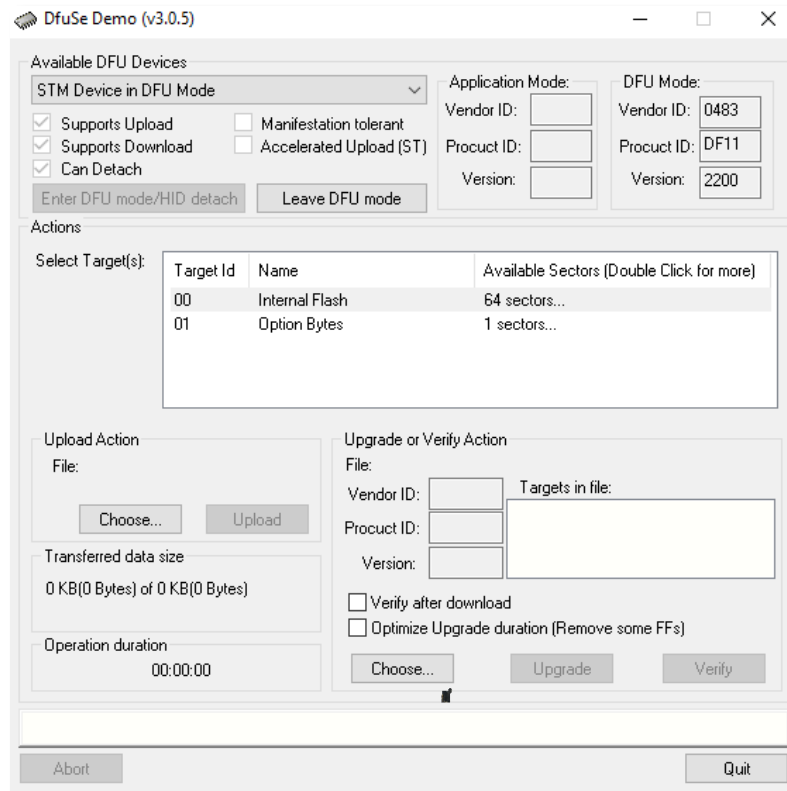

6.6.5.7. Click the **UPGRADE** button

6.6.5.8. After a couple of seconds, the DFU will be uploaded to the beacon. Make sure it takes 1–3 seconds and does not happen instantly. Otherwise, the SW has not been uploaded correctly. If the DFU appears to upload immediately, check the "Choose" button you used or change the version of DfuSe SW you selected

6.6.5.9. Start the Dashboard

6.6.5.10. Reset the beacon again

6.6.5.11. Check SW on the beacon afterwards

6.6.5.12. Everything should be OK with SW now. DFU programming is complete.

DFU Programming for the modem:

6.6.5.13. Here is the [link](#) for the modem DFU programming. The steps are similar to those for beacon DFU programming.

6.6.5.14. After uploading DFU driver by DfuSe short circuit pins as shown on the picture (for v4.9) and press **Reset** button

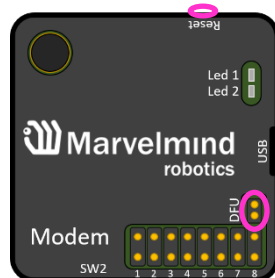

6.6.5.15. Modem will go to DFU mode. Press **UPGRADE** button in the DfuSe program



6.6.5.16. After a couple of seconds, the DFU will be uploaded to the modem. Make sure it takes 1-3 seconds and does not happen instantly. Otherwise, the SW has not been uploaded correctly. If the DFU appears to upload immediately, check the "Choose" button you used or change the version of DfuSe SW to a different one.

6.6.5.17. Disconnect the short circuit.

6.6.5.18. Start the Dashboard and press **RESET** button.

6.6.6. If you have uploaded the latest firmware for all the boards, you can start to activate the system:

6.6.7. While the beacon or modem is connected to the Dashboard, click the **DEFAULT** button on the Dashboard to upload the default settings

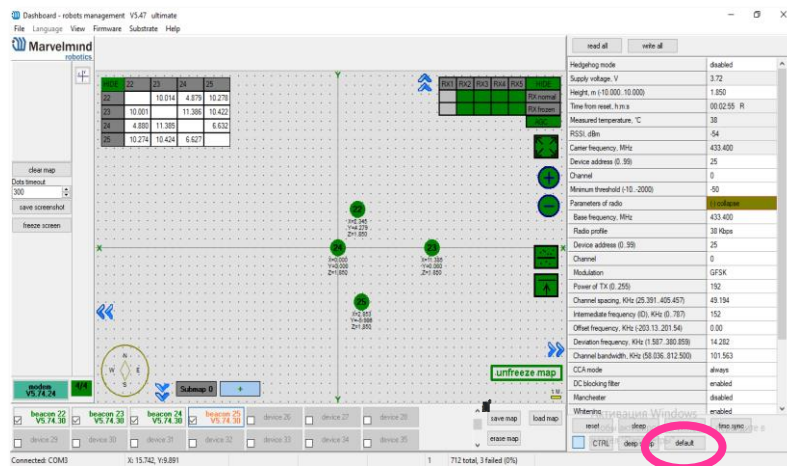

6.6.8. Write down the beacon's address for future use or change the address at your convenience as shown here

heagenog mode	enabled
Inverse system	enabled
Distances only mode	disabled
Supply voltage, V	3.70
Desired speed, % (0..100)	30
Time from reset, h:m:s	00:00:04 R
Measured temperature, °C	23
RSSI, dBm	-74
Radio frequency band	915 MHz
Carrier frequency, MHz	919.000
Device address (0..254)	154
Radio channel	0
Ultrasonic frequency, Hz (100..65000)	n/a
Filter selection	n/a
IMU	(+) expand
Parameters of radio	(+) expand
Ultrasound	(+) expand
Interfaces	(+) expand
Georeferencing	(+) expand
Misc. settings	(+) expand
Hedgehogs pairing	(+) expand
Real-time player	disabled
Real-time player backward (0..127)	3
Real-time player forward (0..127)	5

6.6.9. Choose one of the beacons and enable "Hedgehog mode". Use this beacon as a mobile beacon in future

firmware version	v 7.400 Super-beacon12
Power save functions	enabled / active
Hedgehog mode	enabled
Supply voltage, V (3.50..4.35)	4.00
Time from reset, h:m:s	00:02:55 / 19.20.54 / 0
RSSI from modem, dBm	-81
RSSI to modem, dBm	n/a
Profile	General (915 MHz band)
Carrier frequency, MHz	919.0
Radio channel	0
Device address (1..254)	104
Height, m (-320.000..320.000)	0.000
Measured temperature, °C	23
Ultrasonic frequency, Hz (100..65000)	45000
Advanced settings	(+) expand
IMU	(+) expand

6.6.10. Press the RESET (Industrial beacons have magnetic re button on your beacons and modem after programming

6.6.11. After programming devices with the latest software, the modem and beacons are ready for use

6.6.12. Place the stationary beacons high on the walls vertically in a way that will provide optimal ultrasonic coverage. **Write down the beacon's height for future change in the settings.** The help video on installation can be found here - <https://youtu.be/WY0HkLzmijs>



Side view:

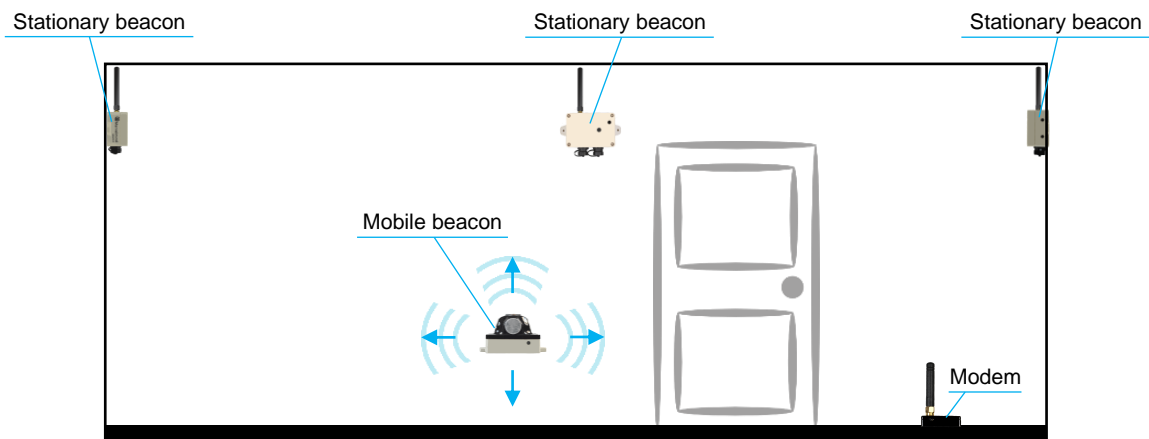

Top view:

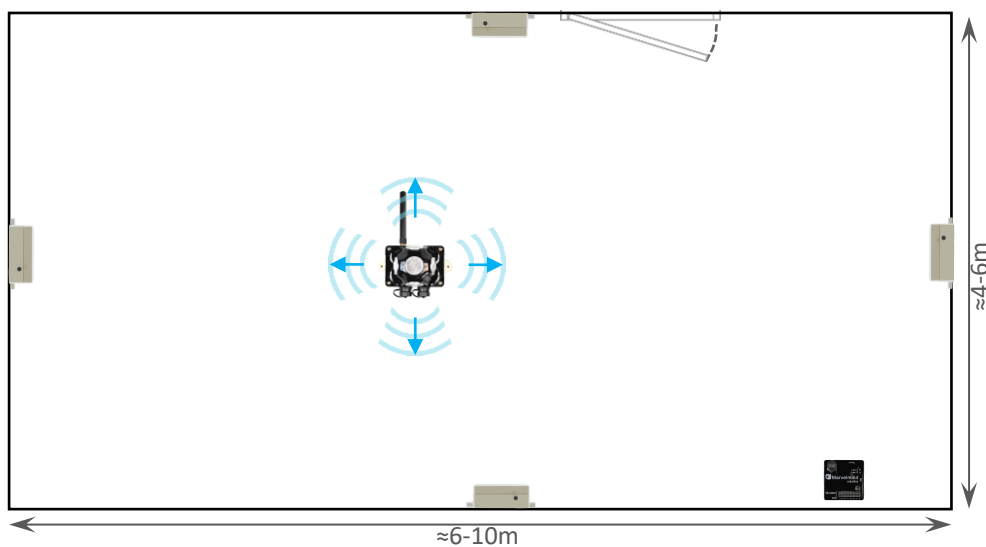

6.6.13. Connect the modem/router via USB to a Windows PC with the Dashboard installed

6.6.14. Run the Dashboard. In the left corner of the Dashboard, the modem should be shown as connected

6.6.15. Wake up all beacons by clicking on the buttons in the Dashboard on the panel

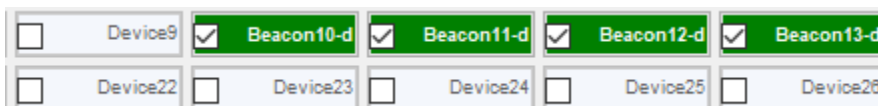

6.6.16. It may take up to 7-10 seconds for the beacons to wake up

6.6.17. If the modem is not active and is not powered, the beacons will go into sleep mode automatically after 1 minute

6.6.18. The system may run the frequency search, if it is the very first time you are waking up the beacons. If this step does not work, disconnect the modem and connect that beacon again via USB. Press the DEFAULT button in the Dashboard and the Read All button to make sure that the radio settings are the default ones

6.6.19. Check that the radio settings on the modem and the radio settings on the beacon are the same

6.6.20. Now you can check RSSI, voltage, ultrasonic filter settings, etc. on the panel on the right corner of the Dashboard

Supply voltage, V	3.95
Desired speed, % (0..100)	30
Height, m (-320.000..320.000)	0.000
Time from reset, h:m:s	00:01:26 R
Measured temperature, °C	23
RSSI, dBm	-28
Radio frequency band	915 MHz
Carrier frequency, MHz	919.000
Device address (0..254)	30
Radio channel	0
Ultrasonic frequency, Hz (100..65000)	25000
Filter selection	31 kHz

6.6.21. Enter the height of stationary beacons. Choose beacon in the list and enter height value

Read all		Write all	
CPU ID	Copy to clipboard	013326	
Firmware version	V6.192 Super-Beacon		
Power save functions	enabled		
Hedgehog mode	enabled		
Inverse system	disabled		
Distances only mode	disabled		
Supply voltage, V	3.95		
Desired speed, % (0..100)	30		
Height, m (-320.000..320.000)	0.000		
Time from reset, h:m:s	00:01:26 R		
Measured temperature, °C	23		
RSSI, dBm	-28		
Radio frequency band	915 MHz		
Carrier frequency, MHz	919.000		
Device address (0..254)	30		
Radio channel	0		
Ultrasonic frequency, Hz (100..65000)	25000		
Filter selection	31 kHz		



Enter the height for mobile beacon if you use 2D mode

6.6.22. In the current version one modem supports 250 beacons (mobile + stationary combined). If you do not see some of your connected beacons on the map, you may need to scroll to find their addresses

6.6.23. Double click on the device to put it into sleep mode or wake it up



Only 4 stationary beacons may be in 1 submap. If you wake up more beacons, create new submap for them. Or it won't be displayed on the map and in the table of distances

6.6.24. Build the map:



Industrial-RX beacons are not possible to build the map automatically, so you have to build it manually

- 6.6.24.1. Open the Dashboard. You will see the table of distances
- 6.6.24.2. Right click on the cell where you want to enter the distance. Additional menu will open. There you can control the table of distances. Choose **Enter distance for pair** to enter the value

HIDE	5	22	66	77
5		7.144	12.389	10.101
22	7.144		10.122	
66	12.389	10.122		
77	10.101	12.151	6.800	

- Freeze distance for pair
- Freeze average for pair
- Don't use distance

- Freeze all
- Unfreeze all

- Enter distance for pair

- Clear cell

- 6.6.24.3. Now, enter measured (measure it with laser distance meter or so) value. That values would not change until you unfreeze or clear it. Even if beacons had been moved, distance would stay. Be careful with frozen cells because a small mistake can cause a huge impact on your tracking
- 6.6.24.4. Repeat for all cells

HIDE	6	22	66	77
6		8.000	4.200	11.400
22	8.000		13.100	6.500
66	4.200	13.100		10.800
77	11.400	6.500	10.800	

- 6.6.25. Freeze the map by clicking the button. Stationary beacons will stop measuring relative distances and will be ready to measure distance from the mobile beacon(s)
- 6.6.26. Turn on and wake up the mobile beacon following the same steps as with the stationary beacon: <https://youtu.be/A4aRsJH2-E>
- 6.6.27. If you see on the devices' panel in the Dashboard that the beacon is colored orange, it means there are some differences in some of the settings between beacons. For example, some sensors may be off or some ultrasonic or radio settings may be different. You can change the settings for sensors manually by clicking on the panel on the upper right corner of the Dashboard to change the cells from gray to green to turn on sensor. It is recommended that the default settings on all beacons and the modem be used if this is your first time using the system
- 6.6.28. After you freeze the map of stationary beacons, wake up the mobile beacon. After it wakes up, it will be traceable within 5-7 seconds



Distances only mode	
Supply voltage, V	
Supply voltage motors, V	0.00
Coordinates (m), X ; Y	0.000 ; 0.000
Desired speed, % (0..100)	30
Speed base, cm/s	200.0
Current speed, cm/s	0.0
Height, m (-320.000..320.000)	0.000
Height, m (-320.000..320.000)	0.000

Reset	Sleep	Wake up	Time sync	Zero IMU
<input type="checkbox"/> CTRL	Deep sleep	Default		
0	0 total, 0 failed (0%)			

6.6.29. The system is now fully operational

Dashboard - robots management v7.048 ultimate

File Language View Firmware Licenses Help

Marvelmind robotics

	9	10	11	12	13
9	6.536	7.599	4.836	3.247	
10			7.629	10.718	9.398
11		7.629		9.483	10.554
12		10.718	9.483		3.145
13		9.398	10.554	3.145	

Clear map
Data timeout, sec: 5
Data size mode: default
Save screenshot
Freeze screen
Real-time Player: Backward Forward
Stream capture: none

Map controls:
Up A, CLEAR, T=5, HOME, SZ on, UP off, Stop, RTF on, SW on, MOV on, MAN on, FUD on, B/D, BMT2, New tag, All, None, Full, L4, Submap 0, L4

Robot status:
12: x=18, y=229, z=0.000
13: x=130, y=110, z=0.000
11: x=0.000, y=0.000, z=0.000
10: x=130, y=0.000, z=0.000

Parameters table:

Read all	Write all	Write changes	Cancel changes
CPU ID	Copy to clipboard	02125A	
Firmware version		v7.048 Super-Beacon	
Power save functions		enabled / active	
Hedgehog mode		disabled	
Supply voltage: V (D.S. 4.2)		3.95	
Time from reset: h:m:s		00:05:44 / 19:18:37 / 0	
RSSI from modem: dBm		-47	
RSSI to modem: dBm		-45	
Profile		General	
Radio frequency band		~915 MHz*	
Carrier frequency: MHz		915.8	
Radio channel		0	
Device address (I. 254)		10	
Height: m (320 000..320 000) in submap 0		0.000	
Measured temperature: °C		23	
Ultrasonic frequency: Hz (100..65000)		21000	
Cleared speed: % (0..100)		n/a	
IMU		on required	
Parameters of radio		on required	
Ultrasonic		on required	
Interfaces		on required	
Misc. settings		on required	
Hedgehogs panning		on required	
Real-time player		disabled	
Real-time player backward (0..127)		3	
Real-time player forward (0..127)		5	

Update, Auto, Apply, Unfreeze map, Unfreeze submap

Save map, Load map, Erase map, new

Reset, Sleep, Wake up, Time sync, Zero IMU

Connected: COM7
X: 7.951, Y: -3.245
Rate: 3.6 Hz
2 / 141 total, 0 failed (0%)

7. Dashboard menu and Parameters

7.1. Dashboard general view

This picture shows the Dashboard's general interface and items' positions

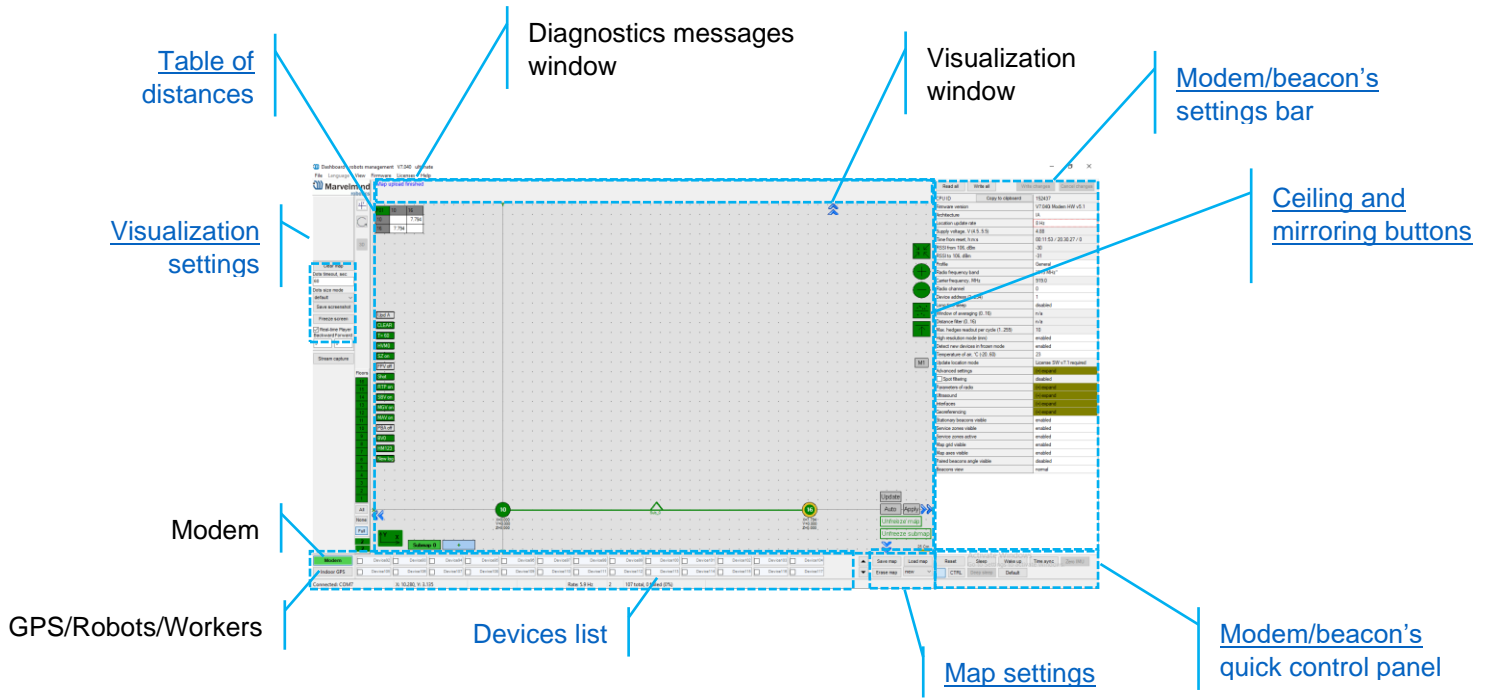

7.2. Diagnostics messages window

Diagnostic messages window is an area where important system's messages appears. It may contain a lot of useful information.

Diagnostics window is placed on the top of the Dashboard.

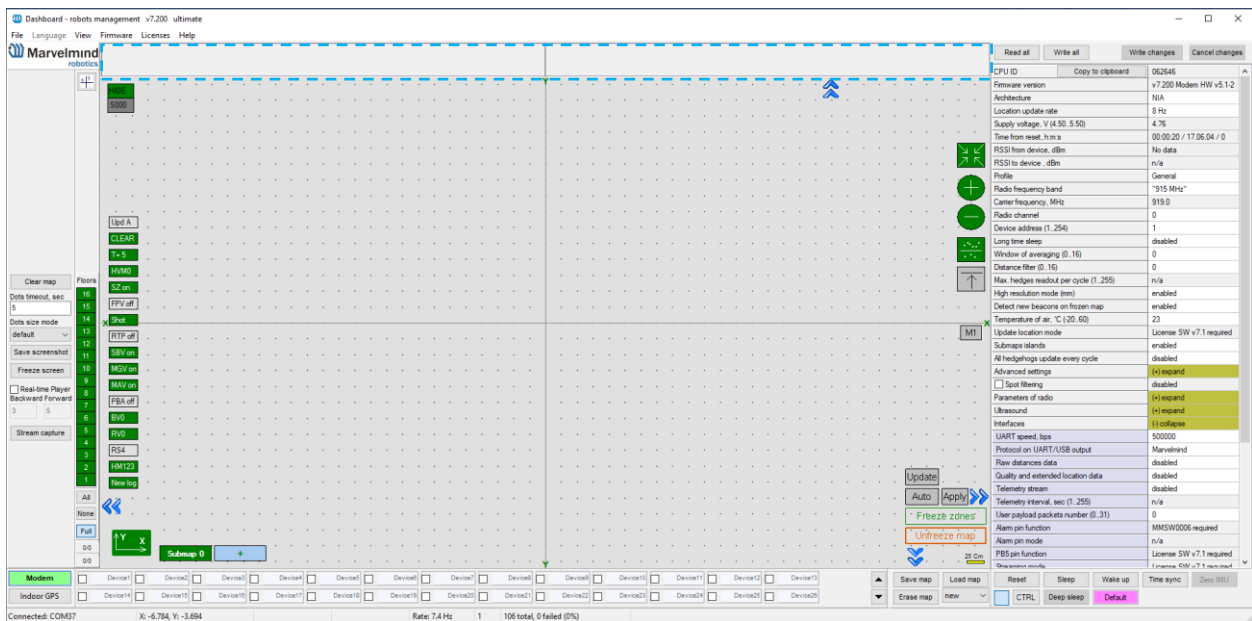

If the field is empty, that means that system didn't find any issues for the launch. If you have any messages, please check it carefully and fix the issue.

There are 4 categories of reports:

- Orange – minor issue
- Red – major issue
- Green – Successfully completed settings
- Blue – Successfully completed process

Here is the list of the messages (relevant for Dashboard v7.200):

Left diagnostic window:

- Same ultrasonic frequency in submap0 beacons: n2, n3 - use beacons with different frequencies in IA submaps
- Paired beacons 25/26 ultrasonic and IMU fusion not completed. Angular difference: 45 degrees appears if angle difference between beacons more than 5 degrees
- IA architecture can't be selected. Upload IA firmware to modem
- NIA architecture can't be selected. Upload NIA firmware to modem
- MF NIA architecture can't be selected. Upload NIA firmware to modem
- No MF NIA license (MMSW0004) for beacons n5, n6, n7. Buy the license. MF NIA doesn't work even if license not activated for one beacon in the system.
- Device N10 (V7.000) not supported
- N10 (V7.000) - too old. Update firmware
- N10 (V7.000) - newer than dashboard. Update dashboard
- N10 (V7.000) - older than modem. Update firmware
- N10 (V7.000) - newer than modem. Update modem firmware
- Mixed IA and NIA devices
- UBX protocol for PX4 requires license MMSW0003. Buy the license.
- Beacons not assigned to submaps: n10, n11. All submaps frozen. Unfreeze or add submap
- Beacons not assigned to submaps: n10, n11. Maximum 4 beacons per submap. Add submap
- Beacons too close: n10, n11. Place beacons at least 2 meters from modem
- Devices with duplicated address: n10, n11
- FEC mismatch to modem: n10, n11 - change FEC in radio parameters
- Discharged devices: n10, n11
- Distances were changed in frozen submap0
- Sleeping beacons in frozen submap0
- Network setting read failed - Error reading Super-Modem network settings
- Network setting write failed - Error writing super modem network settings

- Not found UWB device - connect UWB beacon or UWB modem to modem HW v5.1 (only for Marvelmind UWB devices. In progress)
- Single hedge readout per cycle - increase the value and refreeze the map - In IA, in the modem settings, the number of transmitted coordinates of hedgehogs per cycle 1 is entered. This greatly slows down the update of coordinates of hedgehogs in the dashboard (if there are many of them). By default, this parameter is 10
- Modem HW v4.9 doesn't support MF NIA
- You need at least 3 beacons for MF NIA. Add beacons.
- Uploading map to beacons n10, n11, n12
- Check table of distances for submap 0 – Table of distance is not white (there are discrepancies in distances)
- More than one beacon nailed to floorplan: n10, n11. Unnail for scaling

- Floorplan scaling: click first point on floorplan. ESC to cancel.
- Floorplan scaling: click second point on floorplan. ESC to cancel.
- Floorplan is glued. Can't scale
- Floorplan is glued. Can't move
- Can't move submap - beacons n10, n11 are nailed to floorplan
- Can't move submap - beacons n10, n11 are fixed
- Can't rotate submap - beacons n10, n11 are nailed to floorplan
- Can't rotate submap - beacons n10, n11 are fixed
- Can't move: beacon n10 is nailed to floorplan
- More than one fixed beacon in submap0. Submap doesn't automatically rebuild
- Not found USB connection. Possibly driver not installed. Download and install driver
- Can't set manual location. Beacon 10 is in frozen submap0. Unfreeze for manual location
- Enable Interfaces/IMU via modem/Raw IMU data to see gyro
- Enable Interfaces/IMU via modem/Raw IMU data to see accelerometer
- Beacon n10 has no license MMSW0007. Buy the license
- Beacon n10 has no license MMSW0008. Buy the license
- Map upload finished
- Switch to recorded state 719 - Revert to previous state by CTRL+Z (license 7.1 required)
- Licenses updated
- Paired beacons 25/26 ultrasonic and IMU fusion completed. Angular difference: 2 degrees. 4
- Network setting read completed
- Network setting write completed

Right diagnostic window:

- Adding beacons on frozen map disabled
- Stream capture mode was disabled
- Map is not frozen
- Submaps not frozen: 0, 1, 2
- No optional SW pack license (MMSW0005) for beacons: n10, n11
- Stream capture mode enabled

7.3. Table of distances

Table of distances shows the measured distance between all beacons. The map and its graphical visualization depend on distances, which is a very important part of the system.

There are two ways of measuring:

- Measuring by ultrasound (automatic)
- Measuring by user (manual)

Measuring by ultrasound is impossible for Mini-RX and Industrial-RX beacons
In noisy cases and cases with long distances it is better to use manual input

7.3.1. Measuring by ultrasound:

- In most cases, the system builds the table of distances automatically. If everything is good, there would be figures in cells, they would be changing a little; the color of each cell would be white

HIDE	5	22	66	77
5		7.144	12.389	10.101
22	7.144		10.122	12.151
66	12.389	10.122		6.879
77	10.101	12.151	6.879	

- If color differs, check the colors' definitions (next page) and solve the problem
- Freeze the map only if cells are white

7.3.2. Measuring by user (necessary for Mini-RX beacons and noisy cases):

- Use manual input if table of distances didn't build. It may happen if environment is very noisy, or distances are very huge
- In that case, cells' color would be green
- Be careful with figures because a small mistake in the values will cause mistakes in location

How to freeze/enter distance manually:

7.3.2.1. Open the Dashboard. You will see the table of distances

7.3.2.2. Right click on the cell you want to freeze/enter. Additional menu will open. There you can control the table of distances. Choose **Freeze distance for pair** to freeze it

HIDE	5	22	66	77
5		7.144	12.300	10.101
22	7.144		10.1	
66	12.389	10.122		
77	10.101	12.151	6.8	

Freeze distance for pair

Freeze average for pair

Don't use distance

Freeze all

Unfreeze all

Enter distance for pair

Clear cell

7.3.2.3. Now, cells are frozen. That values would not change until you unfreeze it. Even if beacons had been moved, distance would stay. Be careful with frozen cells because a small mistake can cause a huge impact on your tracking

HIDE	6	22	66	77
6		8.000	27.378	5.054
22	8.000		28.688	18.739
66	33.772	29.794		18.741
77	17.315	7.585	3.522	

7.3.2.4. Repeat for all cells

HIDE	6	22	66	77
6		8.000	4.200	11.400
22	8.000		13.100	6.500
66	4.200	13.100		10.800
77	11.400	6.500	10.800	

- White means that everything is good, you can freeze the map
- Yellow means that something seems to be wrong, check distances and sensors before freezing
- Red means some critical misses, **DO NOT freeze the map**. Manually measure and enter distances
- Green means frozen distance, you can freeze the map, but be careful with values

7.4. Devices List

Devices list contains information about all the beacons in the system. It also allows to search, add and delete it.

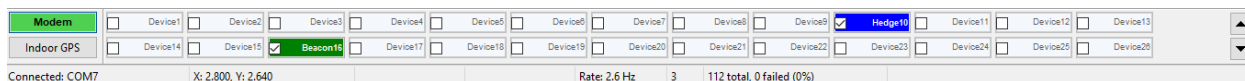

Devices in this section are divided into two types:

- Stationary beacon (beacon)
- Mobile beacon (hedge)

Devices list allows user to manage devices
Use double click to put beacon into sleep mode

7.4.1. Stationary beacon (beacon)

- Right click to open additional menu
There you can:
 - Remove beacon from current submap
 - Remove beacon from the whole network
 - Manually setup coordinates (x, y, z)

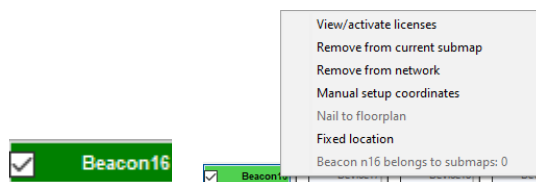

7.4.2. Mobile beacon (hedge)

- Right click to open additional menu
There you can:
 - Remove beacon from the network
 - Setup movement path
 - Upload zones (allowed and denied)
 - Manually setup coordinates (x, y, z)

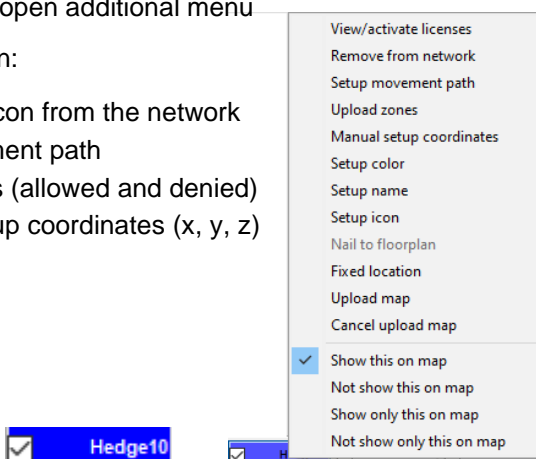

7.5. Visualization settings

Visualization settings window has some functions to control visualization process:



- Clear map – clear all movement path
- Dots timeout – time of path's existence (Video: [Help: Dots timeout](#))
- Dots size mode – size of dots
- Save screenshot – files save to **Dashboard's folder/screenshots**
- Freeze screen – The map freeze, no updates of the path

Clear map	
Dots timeout, sec	
60	
Dots size mode	
default ▾	
Save screenshot	
Freeze screen	
<input checked="" type="checkbox"/> Real-time Player	
Backward Forward	
3	5
Stream capture	

7.6. Map Settings

Map Settings offer some helpful tools:

- Save map – saves map as *.ini* file into **Dashboard folder/maps**
- Load map – loads map from *.ini* format file
- Erase map – erases map and clears it
- New/merge – build new map or upgrade current map

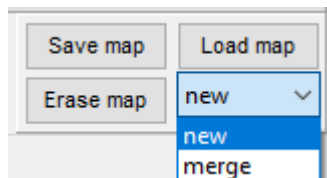

7.7. Modem/beacon's quick control panel

Control panel allows user to interact with devices. It can work with one device, or with all devices in the system.

List of functions:

- Reset – Resets device
- Sleep – Send device asleep (battery economy mode)
- Wake up – Wakes up device (from sleeping mode)
- Default – Drops all device's settings to factory default
- Time sync – Sends time from your PC to hedgehog (for stream it out via UART)

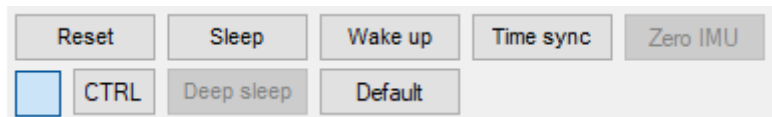

Additional Ctrl feature:

- To apply action to all beacons in the system, use **Ctrl + Left Click** on button. Applicable only for buttons that turn **bold** while Ctrl is pressed.

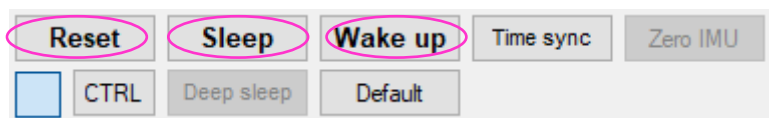

7.8. Ceiling and Mirroring buttons on the Dashboard

- The **Mirroring** button allows the map to be display as a mirror reflection



- The **Ceiling** button shows where the mobile beacon is located with respect to the stationary beacons



- When the arrow points up, it means that the mobile beacon is below the stationary beacons



- When the arrow points down, it means that the mobile beacon is **above the stationary beacons**



- The **Center Map** button





7.9. Detailed settings

This bar allows user to adjust devices very precisely. It contains a lot of parameters for advanced usage

7.9.1. Modem Settings

7.9.1.1. Basic Settings

CPU ID	<input type="button" value="Copy to clipboard"/>	152437	Unique processor ID for each device (beacon or modem)
Firmware version		v7.046 Modem HW v5.1	Firmware version of device (beacon or modem)
Architecture		NIA	Architecture type (IA or NIA)
Location update rate		8 Hz	Location update rate settings: 1/20Hz – 16Hz+. Notice that real update rate may be limited by distances between beacons or radio profile
Supply voltage, V (4.5..5.5)		4.87	Power supply voltage of the device 5V+-0.2V is OK
Time from reset, h:m:s		00:59:13 / 15.41.48 / 0	Time from the latest reset
RSSI from 010, dBm		-50	Strength of the radio signal to modem from beacons and vice versa. Maintain in the range of -25dBm to -80..-90dBm. Higher value - may overload. Lower – lost packets
RSSI to 010, dBm		-49	
Profile		General	Strength of the radio signal from modem to beacons and vice versa. Maintain in the range of -25dBm to -80..-90dBm. Higher value - may overload. Lower – lost packets
Radio frequency band		"915 MHz"	
Carrier frequency, MHz		919.0	Chosen working band
Radio channel		0	Exact working frequency
Device address (1..254)		1	
Long time sleep		disabled	
Window of averaging (0..16)		4	
Distance filter (0..16)		0	
Max. hedges readout per cycle (1..255)		n/a	
High resolution mode (mm)		enabled	
Detect new beacons on frozen map		enabled	
Temperature of air, °C (-20..60)		23	
Update location mode		License SW v7.1 required	

CPU ID	Copy to clipboard	152437
Firmware version		v7.046 Modem HW v5.1
Architecture		NIA
Location update rate		8 Hz
Supply voltage, V (4.5..5.5)		4.88
Time from reset, h:m:s		00:00:27 / 17.01.04 / 0
RSSI from 009, dBm		-37
RSSI to 009, dBm		-33
Profile		General
Radio frequency band		"915 MHz"
Carrier frequency, MHz		919.0
Radio channel		0
Device address (1..254)		1
Long time sleep		disabled
Window of averaging (0..16)		4
Distance filter (0..16)		0
Max. hedges readout per cycle (1..255)		n/a
High resolution mode (mm)		enabled
Detect new beacons on frozen map		enabled
Temperature of air, °C (-20..60)		23
Update location mode		License SW v7.1 required

Pre-selected channel – one of the radio channels for communication between modem and beacons

Logical address of the device. Keep 2..255 for beacons. Address

TBD

Averaging between location update measurements. More value – less location jitter, but higher latency

Filter of distances (as opposed to filter of locations). More – better filtering, but may be too conservative and “kill” good measurements

TBD

Keep Enabled normally. Switch to cm for backward compatibility

If map is frozen, new beacons will be accepted in the map, if enabled

Measured temperature of the processor's crystal

TBD

7.9.1.2. Advanced settings

Advanced settings	(-) collapse
Movement filtering	disabled
Maximum speed, m/s (0.1..60.0)	n/a
Use pairs of beacons	disabled
Filter by acceleration	n/a
Minimum signal quality (0..100)	10
Track with low signal	blue
Auto upload map to hedgehogs	enabled
<input type="checkbox"/> Reset timeout w/o dashboard, min (1..127)	disabled
Hedges timing correction, ms (-127..127)	n/a
Fast submaps search	disabled
<input type="checkbox"/> Spot filtering	disabled

TBD

TBD

TBD

TBD

TBD

TBD

TBD

TBD

TBD

TBD

TBD

TBD

TBD

TBD

TBD

TBD

TBD

TBD

TBD

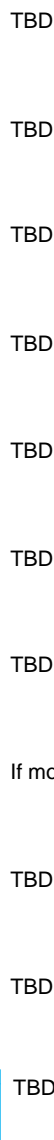

If modem lost connection it restarts by itself

7.9.1.3. Parameters of radio

Parameters of radio	(-) collapse
Base frequency, MHz	919.000
Radio profile	38 Kbps
Device address (0..99)	77
Channel	1
Modulation	GFSK
Power of TX	9 dBm
Channel spacing, KHz (25.391..405.457)	49.190
Intermediate frequency (ID), KHz (0..787)	152
Offset frequency, KHz (-203.13..201.54)	76.16
Deviation frequency, KHz (1.587..380.859)	20.628
Channel bandwidth, KHz (58.036..812.500)	101.553
CCA mode	always
DC blocking filter	enabled
Manchester	disabled
Whitening	enabled
FEC	enabled

Real carrier frequency

Selected radio profile with a set of profile settings. Choose between 38kbps (better range and interference immunity, but slower); 153kbps – balanced; and 500kbps – the fastest, but the lowest radio range and least immune to interference

Logical address of the device. Distinguish of beacon from another

One of a predefined radio frequency channels

Modulation – a part of the radio profile. Only for advanced users

Only for advanced users

Only for advanced users

Only for advanced users

Parameters of radio	(-) collapse
Base frequency, MHz	919.000
Radio profile	38 Kbps
Device address (0..99)	77
Channel	1
Modulation	GFSK
Power of TX	9 dBm
Channel spacing, KHz (25.391..405.457)	49.190
Intermediate frequency (ID), KHz (0..787)	152
Offset frequency, KHz (-203.13..201.54)	76.16
Deviation frequency, KHz (1.587..380.859)	20.628
Channel bandwidth, KHz (58.036..812.500)	101.553
CCA mode	always
DC blocking filter	enabled
Manchester	disabled
Whitening	enabled
FEC	enabled

Radio profile settings. No need to change manually. Only for advanced users

Radio profile settings. No need to change manually. Only for advanced users

Radio profile settings. No need to change manually. Only for advanced users

Radio profile settings. No need to change manually. Only for advanced users

Radio profile settings. No need to change manually. Only for advanced users

Radio profile settings. No need to change manually. Only for advanced users

Radio profile settings. No need to change manually. Only for advanced users

Radio profile settings. No need to change manually. Only for advanced users

7.9.1.4. Interfaces

Interfaces	(-) collapse	
UART speed, bps	500000	Speed of UART
Protocol on UART/USB output	Marvelmind	Type of protocol
Raw distances data	disabled	Enable or disable receiving raw IMU data with IMU update rate (100Hz)
Quality and extended location data	disabled	TBD
Telemetry stream	disabled	TBD
Telemetry interval, sec (1..255)	n/a	TBD
PB4 pin function	License SW v7.1 required	TBD
PB5 pin function	License SW v7.1 required	TBD
Streaming mode	License SW v7.1 required	TBD
Debugging data	disabled	TBD
SPI data output	n/a	TBD
		TBD
		TBD
		TBD
		TBD
		TBD

7.9.2. Beacon's settings

7.9.2.1. Basic settings

CPU ID	Copy to clipboard	143333
Firmware version		v7.044 Super-Beacon-2
Power save functions		enabled / active
Hedgehog mode		disabled
Supply voltage, V (3.5..4.2)		3.83
Time from reset, h:m:s		00:00:30 / 18.12.10 / 0
RSSI from modem, dBm		-41
RSSI to modem, dBm		-41
Profile		General
Radio frequency band		"915 MHz"
Carrier frequency, MHz		919.0
Radio channel		0
Device address (1..254)		12
Height, m (-320.000..320.000) in submap 0		0.000
Measured temperature, °C		23
Ultrasonic frequency, Hz (100..65000)		37000
Desired speed, % (0..100)		n/a
IMU		(+) expand
Parameters of radio		(+) expand
Ultrasound		(+) expand
Interfaces		(+) expand
Misc. settings		(+) expand
Hedgehogs pairing		(+) expand
Real-time player		disabled
Real-time player backward (0..127)		3
Real-time player forward (0..127)		5

Unique CPU ID

Firmware version of device (beacon or modem)

TBD

Enable for mobile beacon and disable for stationary beacon

Measured voltage of internal battery

Time from the latest reset

Strength of the radio signal from modem to this beacon, i.e. how the beacon "hears" the modem over radio. Keep below -25dBm and above -80dBm to avoid losses of packets. Lower end depends on radio profile and interference

Strength of the radio signal from this beacon to the modem, i.e. how the modem "hears" the beacon over radio. Keep below -25dBm and above -80dBm to avoid losses of packets. Lower end depends on radio profile and interference

TBD

Select radio frequency band according to your HW: 433MHz or 915MHz

Real carrier frequency

CPU ID	Copy to clipboard	143333
Firmware version		v7.044 Super-Beacon-2
Power save functions		enabled / active
Hedgehog mode		disabled
Supply voltage, V (3.5..4.2)		3.83
Time from reset, h:m:s		00:00:30 / 18.12.10 / 0
RSSI from modem, dBm		-41
RSSI to modem, dBm		-41
Profile		General
Radio frequency band		"915 MHz"
Carrier frequency, MHz		919.0
Radio channel		0
Device address (1..254)		12
Height, m (-320.000..320.000) in submap 0		0.000
Measured temperature, °C		23
Ultrasonic frequency, Hz (100..65000)		37000
Desired speed, % (0..100)		n/a
IMU		(+) expand
Parameters of radio		(+) expand
Ultrasound		(+) expand
Interfaces		(+) expand
Misc. settings		(+) expand
Hedgehogs pairing		(+) expand
Real-time player		disabled
Real-time player backward (0..127)		3
Real-time player forward (0..127)		5

Selected radio channel

Selected device's address

Height – must be set for stationary beacons.
Must also be set for mobile beacons in 1D or 2D modes

Processor's crystal's temperature

Frequency of ultrasonic pulses – set according to your HW

TBD

TBD

TBD

TBD

7.9.2.2. IMU

IMU	(-) collapse
Ax zero	-10
Ay zero	8
Az zero	-122
Ax K	0.982
Ay K	0.973
Az K	0.982

Calibration settings of embedded IMU: X shift

Calibration settings of embedded IMU: Y shift

Calibration settings of embedded IMU: Z shift

Calibration settings of embedded IMU: X scale

Calibration settings of embedded IMU: Y scale

Calibration settings of embedded IMU: Z scale

7.9.2.3. Parameters of radio

Parameters of radio	(-) collapse
Base frequency, MHz	919.000
Radio profile	38 Kbps
Device address (0..99)	77
Channel	1
Modulation	GFSK
Power of TX	9 dBm
Channel spacing, KHz (25.391..405.457)	49.190
Intermediate frequency (ID), KHz (0..787)	152
Offset frequency, KHz (-203.13..201.54)	76.16
Deviation frequency, KHz (1.587..380.859)	20.628
Channel bandwidth, KHz (58.036..812.500)	101.553
CCA mode	always
DC blocking filter	enabled
Manchester	disabled
Whitening	enabled
FEC	enabled

Real carrier frequency

Radio profile that is linked with many radio settings below. Helps to set them at once by choosing the profile. See similar in modem for more info

Device address – shall be set for each beacon different under one modem

One of the pre-selected frequency channels

Radio profile settings. No need to change manually. Only for advanced users

Radio profile settings. No need to change manually. Only for advanced users

Radio profile settings. No need to change manually. Only for advanced users

Radio profile settings. No need to change manually. Only for advanced users

Parameters of radio	(-) collapse
Base frequency, MHz	919.000
Radio profile	38 Kbps
Device address (0..99)	77
Channel	1
Modulation	GFSK
Power of TX	9 dBm
Channel spacing, KHz (25.391..405.457)	49.190
Intermediate frequency (ID), KHz (0..787)	152
Offset frequency, KHz (-203.13..201.54)	76.16
Deviation frequency, KHz (1.587..380.859)	20.628
Channel bandwidth, KHz (58.036..812.500)	101.553
CCA mode	always
DC blocking filter	enabled
Manchester	disabled
Whitening	enabled
FEC	enabled

Radio profile settings. No need to change manually. Only for advanced users

Radio profile settings. No need to change manually. Only for advanced users

Radio profile settings. No need to change manually. Only for advanced users

Radio profile settings. No need to change manually. Only for advanced users

Radio profile settings. No need to change manually. Only for advanced users

Radio profile settings. No need to change manually. Only for advanced users

Radio profile settings. No need to change manually. Only for advanced users

Radio profile settings. No need to change manually. Only for advanced users

7.9.2.4. Ultrasound

Ultrasound	(-) collapse
Mode of work	TX+RX normal
High voltage TX settings	(+) expand
Analog power in sleep	disabled
Power after transmission	not turn off
Transmitter mode	PWM
Frequency, Hz (100..65000)	31000
Duty, % (1..99)	50
Number of periods (1..100)	5
Amplifier limitation (calibrated)	4000
Amplification	AGC
Time gain control	disabled
AGC desired level (-1800..0)	-500
AGC hysteresis (10..2000)	130
AGC step, dB (1..20)	3
Mode of threshold	automatic
Minimum threshold (-10..-2000)	-50
Threshold to noise, dB (3..100)	6
Signal detection	by ADC
Periods for detector (3..50)	5
Min. speed of raise, LSB/cm (0.5..127.0)	5.0
Min. over raise for new front (0..200)	10
Coef. of estimated front quality (0..200)	8
Maximum line gradient down, % (0..200)	0
Maximum triple deviation, % (0..250)	150
Maximum points to skip (0..5)	2

TX-RX – regular mode. Use it. The rest - internal

TBD

Power saving features. If not sure, keep default

Power saving features. If not sure, keep default

TBD

Frequency of ultrasonic pulses – set according to your HW

50% - default. 1% ... 99% lower strength of ultrasonic. Keep default

Number of ultrasonic pulses the TX beacon emits. More – stronger, but longer echo. For small distances – 1-10 periods. 20-30 – for 10-20 meters. For 20+ m – 50 periods

Internal settings

Automatic or manual gain control. Manual can be useful in special conditions: too high external audio noise, for example

Ultrasound	(-) collapse
Mode of work	TX+RX normal
High voltage TX settings	(+) expand
Analog power in sleep	disabled
Power after transmission	not turn off
Transmitter mode	PWM
Frequency, Hz (100..65000)	31000
Duty, % (1..99)	50
Number of periods (1..100)	5
Amplifier limitation (calibrated)	4000
Amplification	AGC
Time gain control	disabled
AGC desired level (-1800..0)	-500
AGC hysteresis (10..2000)	130
AGC step, dB (1..20)	3
Mode of threshold	automatic
Minimum threshold (-10..-2000)	-50
Threshold to noise, dB (3..100)	6
Signal detection	by ADC
Periods for detector (3..50)	5
Min. speed of raise, LSB/cm (0.5..127.0)	5.0
Min. over raise for new front (0..200)	10
Coef. of estimated front quality (0..200)	8
Maximum line gradient down, % (0..200)	0
Maximum triple deviation, % (0..250)	150
Maximum points to skip (0..5)	2

TBD

AGC settings. For advanced users only

AGC settings. For advanced users only

AGC settings. For advanced users only

AGC settings. For advanced users only

Deep ultrasonic trigger settings. For special cases only

Deep ultrasonic trigger settings. For special cases only

Keep ADC

Deep ultrasonic trigger settings. For special cases only

Deep ultrasonic trigger settings. For special cases only

Ultrasound	(-) collapse
Mode of work	TX+RX normal
High voltage TX settings	(+) expand
Analog power in sleep	disabled
Power after transmission	not tum off
Transmitter mode	PWM
Frequency, Hz (100..65000)	31000
Duty, % (1..99)	50
Number of periods (1..100)	5
Amplifier limitation (calibrated)	4000
Amplification	AGC
Time gain control	disabled
AGC desired level (-1800..0)	-500
AGC hysteresis (10..2000)	130
AGC step, dB (1..20)	3
Mode of threshold	automatic
Minimum threshold (-10..-2000)	-50
Threshold to noise, dB (3..100)	6
Signal detection	by ADC
Periods for detector (3..50)	5
Min. speed of raise, LSB/cm (0.5..127.0)	5.0
Min. over raise for new front (0..200)	10
Coef. of estimated front quality (0..200)	8
Maximum line gradient down, % (0..200)	0
Maximum triple deviation, % (0..250)	150
Maximum points to skip (0..5)	2

Deep ultrasonic trigger settings. For special cases only

Deep ultrasonic trigger settings. For special cases only

Deep ultrasonic trigger settings. For special cases only

Deep ultrasonic trigger settings. For special cases only

Deep ultrasonic trigger settings. For special cases only

AGC low threshold, raise speed (1..10)	15	Deep AGC settings. For special cases only
Speed of amplification increase (1..200)	10	Deep AGC settings. For special cases only
AGC high threshold, raise speed (1..100)	100	Deep AGC settings. For special cases only
Speed of amplification decrease (1..200)	5	Deep AGC settings. For special cases only
Receive window low, m (0..255)	0	TBD
Receive window high, m (0..255)	255	TBD
Minimum distance limitation	enabled	TBD
Auto measurements when radio gaps	enabled	TBD
Filter selection	19 kHz	TBD
RX1 normal	disabled	TBD
RX2 normal	disabled	TBD
RX3 normal	disabled	TBD
RX4 normal	disabled	TBD
RX5 normal	disabled	TBD
RX1 frozen	disabled	Enable/disable sensor RX1 in map building mode
RX2 frozen	disabled	Enable/disable sensor RX2 in map building mode
RX3 frozen	disabled	
RX4 frozen	disabled	
RX5 frozen	disabled	
Additional parameters	(-) collapse	
Obstacles probe	disabled	
File of dump for DAC		

AGC low threshold, raise speed (1..10)	15
Speed of amplification increase (1..200)	10
AGC high threshold, raise speed (1..100)	100
Speed of amplification decrease (1..200)	5
Receive window low, m (0..255)	0
Receive window high, m (0..255)	255
Minimum distance limitation	enabled
Auto measurements when radio gaps	enabled
Filter selection	19 kHz
RX1 normal	disabled
RX2 normal	disabled
RX3 normal	disabled
RX4 normal	disabled
RX5 normal	disabled
RX1 frozen	disabled
RX2 frozen	disabled
RX3 frozen	disabled
RX4 frozen	disabled
RX5 frozen	disabled
Additional parameters	(-) collapse
Obstacles probe	disabled
File of dump for DAC	

Enable/disable sensor RX3 in map building mode

Enable/disable sensor RX4 in map building mode

Enable/disable sensor RX5 in map building mode

Enable/disable sensor RX1 in map frozen/regular work mode

Enable/disable sensor RX2 in map frozen/regular work mode

Enable/disable sensor RX3 in map frozen/regular work mode

Enable/disable sensor RX4 in map frozen/regular work mode

Enable/disable sensor RX5 in map frozen/regular work mode

TBD

TBD

TBD

7.9.2.5. Interfaces

Interfaces	(-) collapse
UART speed, bps	500000
Protocol on UART/USB output	Marvelmind
PA15 pin function	SPI slave CS
Raw inertial sensors data	disabled
Processed IMU data	disabled

Speed of UART in hedgehog mode

Type of protocol

TBD

Enable or disable receiving raw IMU data with IMU update rate (100Hz)

Enable or disable receiving IMU+ultrasonic sensor fusion data with IMU update rate (100Hz)

7.9.2.6. Georeferencing

Georeferencing	(-) collapse
Latitude	N0.0000000
Longitude	E0.0000000

The same as with modem

The same as with modem

7.9.2.7. Misc. settings

Misc. settings	(-) collapse
Sleep with external power	60 sec no connection

Timeout sleep settings

7.9.2.8. Hedgehogs pairing



Hedgehogs pairing	(-) collapse
Pairing mode	pair
Address of paired hedge (1..255)	8
Location against center	left
Base of the pair, cm (1..255)	10
IMU fusion for angle	enabled
Send location of center	enabled
Communication in pair	n/a

Enable for Paired Beacons feature:
<https://youtu.be/aBWUALT3WTQ>
Also look at chapter 6.13

Activate this parameter to pair beacons

Address of the beacon, current selected hedgehog paired with

Location against center of selected beacon in a pair

Actual distance between paired hedgehogs

TBD

TBD

TBD

7.10. Radio frequency band and Carrier frequency

- For devices with HW 433 MHz allowable Radio bands 315 and 433,
- For devices with HW 915 MHz allowable Radio bands 868 and 915, but when using antennas at 433 MHz it is possible to use both 315 and 433 MHz

*Mini-RX beacons and Super-Beacons are 868/915MHz only

It is possible to change the frequency of radio, but radio performance can be severely degraded. It may be enough for smaller distances, up to 10-20 meters, but not more.

Radio frequency band	433 MHz
Carrier frequency, MHz	433.400

Radio frequency band	315 MHz
Carrier frequency, MHz	315.000

Radio frequency band	915 MHz
Carrier frequency, MHz	919.000

Radio frequency band	868 MHz
Carrier frequency, MHz	869.504



7.11. Different hedgehog colors in the Dashboard

You can choose any color for your hedge, but it still has some permanent colors, which inform you about some tracking issues:

- **Blue** - normal mode and confident tracking
- **Orange** - system provides the best location data possible, but confidence is lower than blue
- **Transparent Blue** - lost radio packets
- **Transparent Orange** – weak ultrasonic coverage

7.12. Different beacons' colors in the Dashboard

Beacons can have different ultrasonic frequency. Because of that, they have different colors to make them easier to distinguish:

- Stationary beacons – Green center – 
- Mobile beacons – Dark blue center – 

Examples:

- Stationary beacons:

-  19KHz beacon
-  22kHz
-  25KHz beacon
-  28kHz
-  31KHz beacon
-  34kHz
-  37KHz beacon
-  45KHz beacon

- Mobile beacons:

-  19KHz beacon
-  22kHz
-  25KHz beacon
-  28kHz
-  31KHz beacon
-  34 kHz
-  37KHz beacon
-  45KHz beacon

8. The Map

8.1. Introduction

Map – the biggest unit in Marvelmind Indoor GPS. It consists of submaps and forms a full map of all stationary devices you have. After you build and tune all the submaps and wake up the mobile beacon, you have to click on Modem icon and Freeze the map. It is the final stage of building the system. After you freeze the map, tracking will appear.

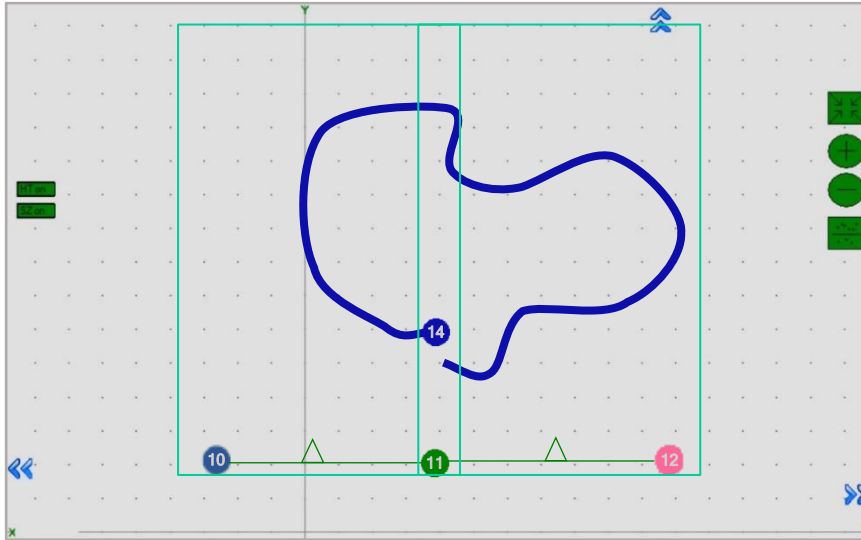

You can **Save, Load, Erase** map:

Map Settings offer some helpful tools, it is situated in the right bottom corner of the Dashboard:

- Save map – saves map as *.ini* file into **Dashboard folder/maps**
- Load map – loads map from *.ini* format file
- Erase map – erases map and clears it

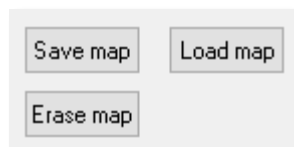

Here is the main tutorial video about maps:

- [Help: submaps, service zones, handover zones](#)

Check:

- [8 basic steps from unpacking to autonomous drive/flight](#)
- [Step-by-step guide on how to build complex maps](#)

Detailed explanation of complex map building:

- [Building submaps: Part 1](#)
- [Building submaps: Part 2](#)



8.2. Map layers

The map consists of several layers. Each layer can be attached to other.

4) Service zones

3) Beacons and Submaps

2) Floorplan –
plan/scheme/picture of
a floor where you
placed beacons

1) Ether – map grid



8.3. The Submap

Submap is a logical unit. A part of the map. It unites beacons to work together in the system. Submap can contain from 1 to 4 beacons. It can be 1D, 2D, and 3D.

Different types of submaps can be used together. Mix 1D, 2D, 3D as you wish. Map of the office floor, for example, may contain 1D submap for corridor, 2D/3D submaps for office rooms. All that submaps will form a big map with coverage you need.

Submaps can contain the same beacons. It makes possible to use 3 beacons instead of 4. It is very helpful in the IA because we are limited with 8 ultrasonic frequencies.

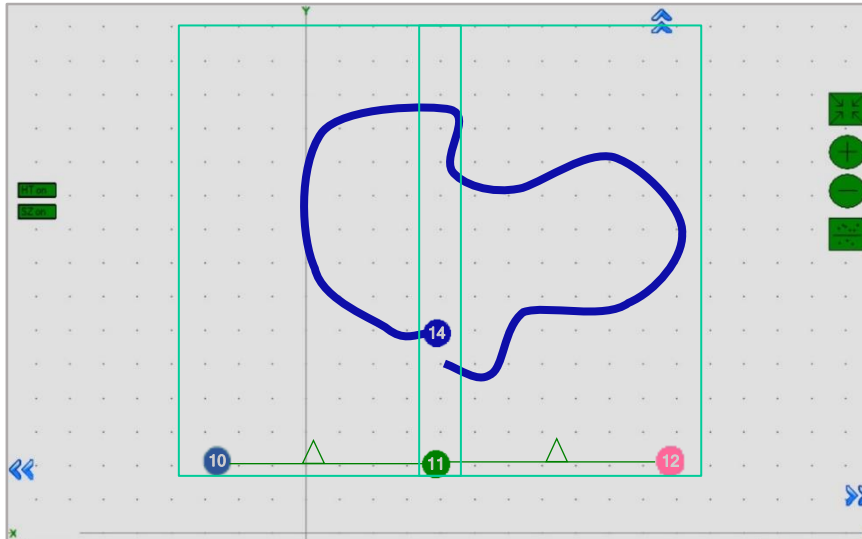

Example 1. Used 3 beacons for 2 2D submaps. Beacon 11 – neighboring. It belongs to Submap 0 and Submap 1 at the same time. 2 vacant frequencies left:

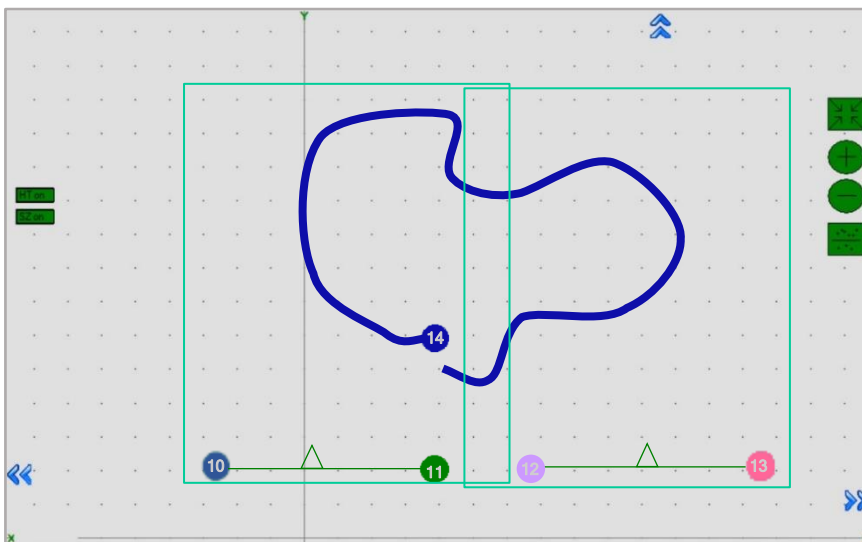

Example 2. Used 4 beacons for 2 2D submaps. Submap 0 and Submap 1 are independent. 1 vacant frequency left:

Different configurations suit different cases. You can also have submaps with neighboring beacons and submaps without it on the one map.

Here is a tutorial video about submaps:

- [Help: using submaps to build large maps](#)

8.4. Submaps' service zones

Service zone (or service area) is an area which serve submap. Service zone must be drawn for any submap you build. It helps to divide tracking between different submaps and outline the area of responsibility of every submap.

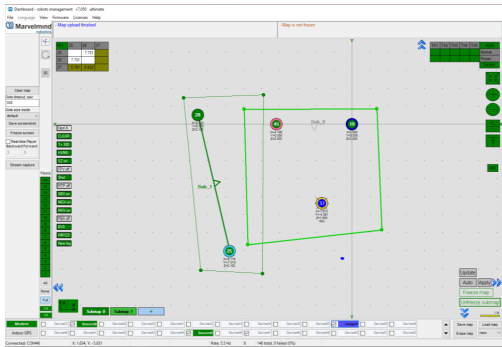
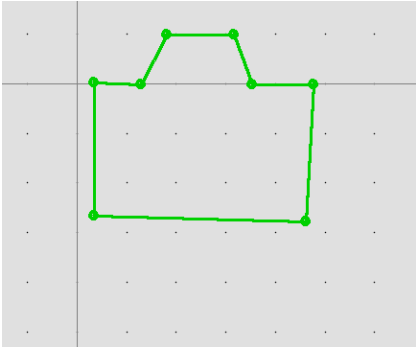

8.5. Handover zones

Handover zone is an area which creates when service zones cross. It serves to make a smooth transfer of mobile beacon from service zone of one submap to another

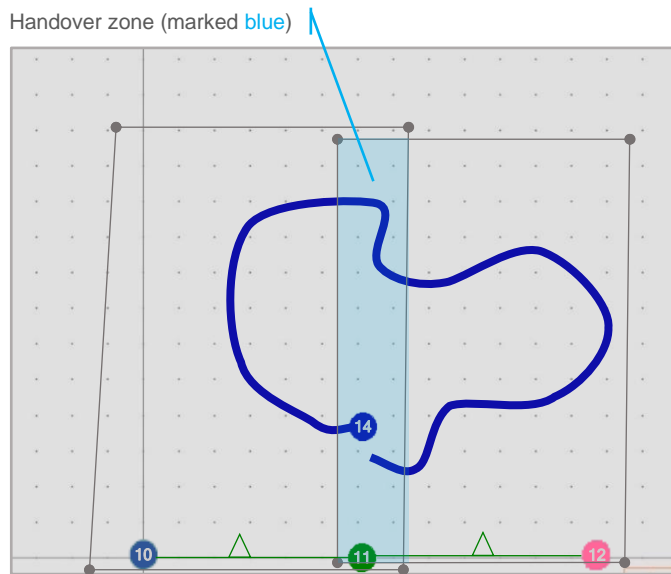

How to create Handover zone correctly:

Size of a Handover zone may be different and depends on the mobile beacon's speed and system's update rate. We recommend testing it with the speed of your mobile beacon mounted on a person/robot/copter. General recommendation is – to make handover smooth and correct, make sure that your mobile beacon makes at least **4 refreshes in a handover zone**.

Look at the following examples:

- **Example 1:** Normal handover zone:

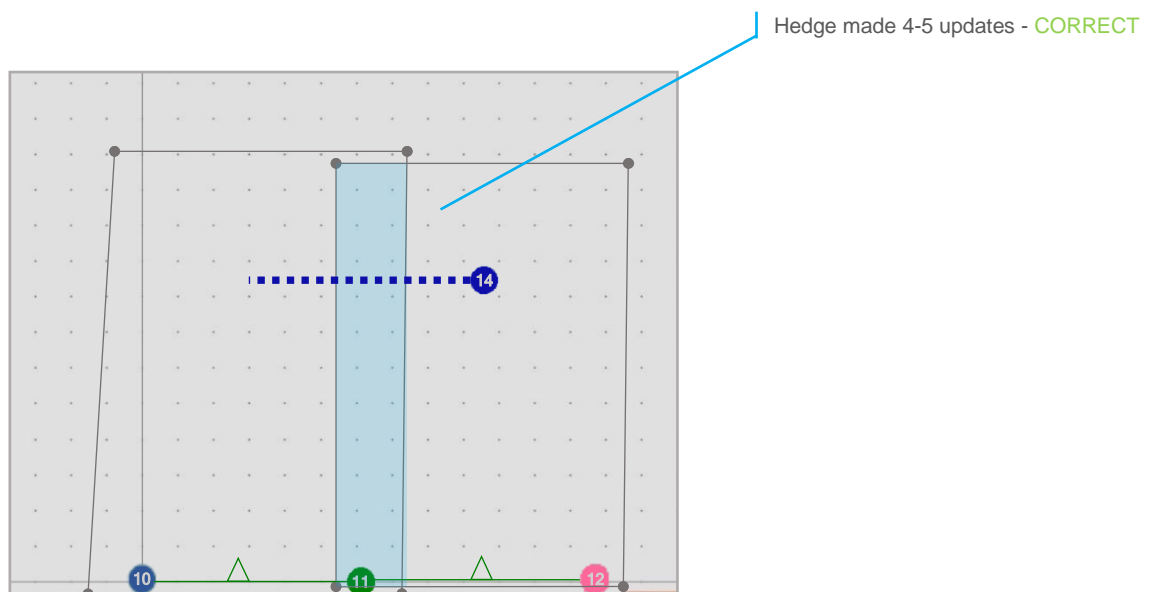

- **Example 2: Small handover zone:**

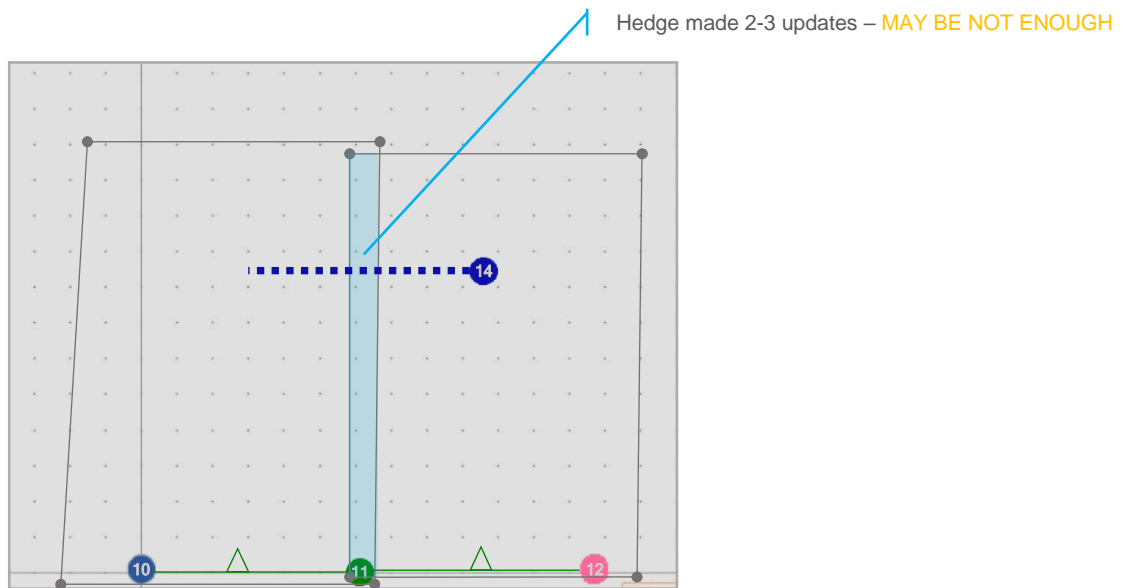

- **Example 3: Very small handover zone:**

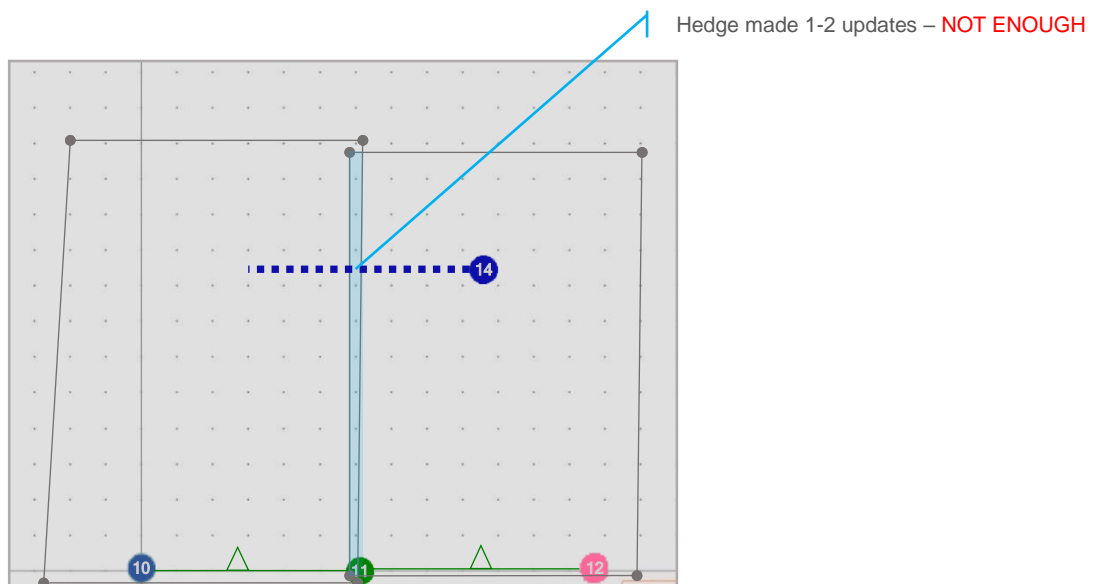

- **Example 4: No handover zone:**

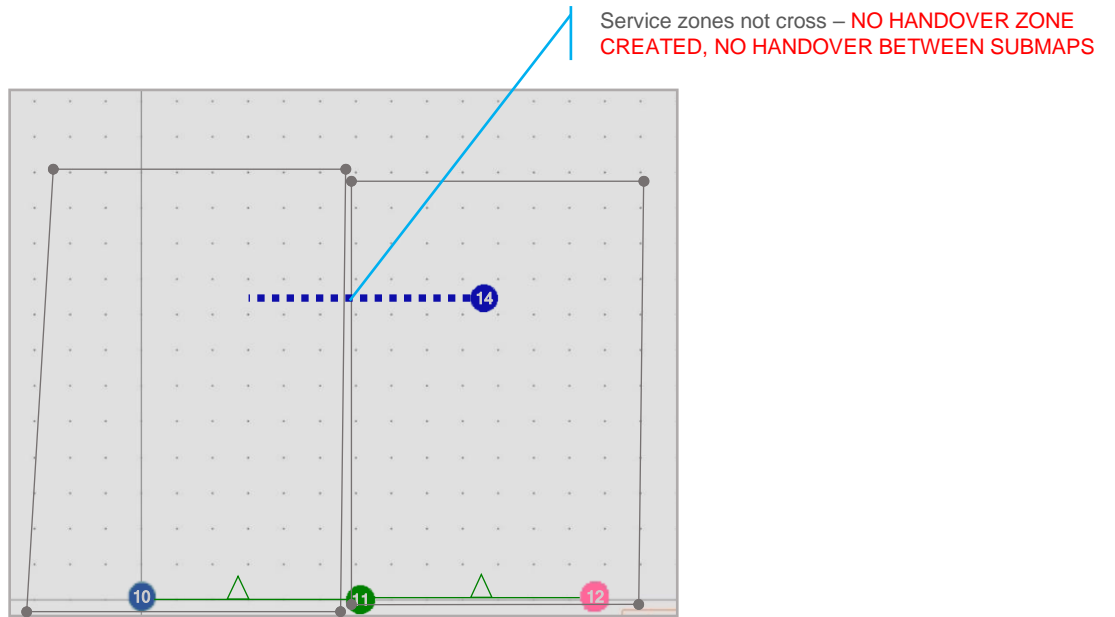

8.6. Beacons' ultrasonic frequencies

Beacons may have different ultrasonic frequencies in the System. It can be used for different aims and different cases. In IA it's necessary to have stationary











Please notice that is hardware defined and cannot be just changed via settings in the Dashboard

Different frequencies can be used:

- In IA as a basic rule of Inverse Architecture's functionality
- In Multi-frequency NIA to increase update rate for multiple mobile beacons

To make it easy to distinguish, stationary beacons with different frequencies in the Dashboard colored in different colors:

-  - 19KHz beacon
-  - 22KHz beacon
-  - 25KHz beacon
-  - 28KHz beacon
-  - 31KHz beacon
-  - 34KHz beacon
-  - 37KHz beacon
-  - 45KHz beacon



Learn more about submaps, service zones and handover zones here: [How to create indoor navigation maps](#)

Learn more about maps larger than 30x30m here: [How to build maps larger than 30x30m](#)

Learn more about building of large indoor positioning systems here: [How to build large indoor positioning systems](#)

Here is the main tutorial video about maps:



- [Help: submaps, service zones, handover zones](#)

- Check:

- [8 basic steps from unpacking to autonomous drive/flight](#)

- [Step-by-step guide on how to build complex maps](#)

- Detailed explanation of complex map building:

- [Building submaps: Part 1](#)

- [Building submaps: Part 2](#)



9. Features

9.1. Licenses

9.1.1. How to activate licenses

Please pay attention that we have different types of licenses: For modem and for beacon. If you need to activate beacon's license – connect the specific beacon to the Dashboard to choose license for that beacon. Connect modem for modem's licenses.

We added the licenses system. Now, you can order some additional features. It is not available in the basic Dashboard version, but you can easily purchase it if necessary. You can see the list on Marvelmind.com -> [Products](#)

To order:

- Go to Marvelmind.com -> [Products](#)
- Choose features which you want to get (e.g. [MMSW0001: 100Hz NMEA0183](#))

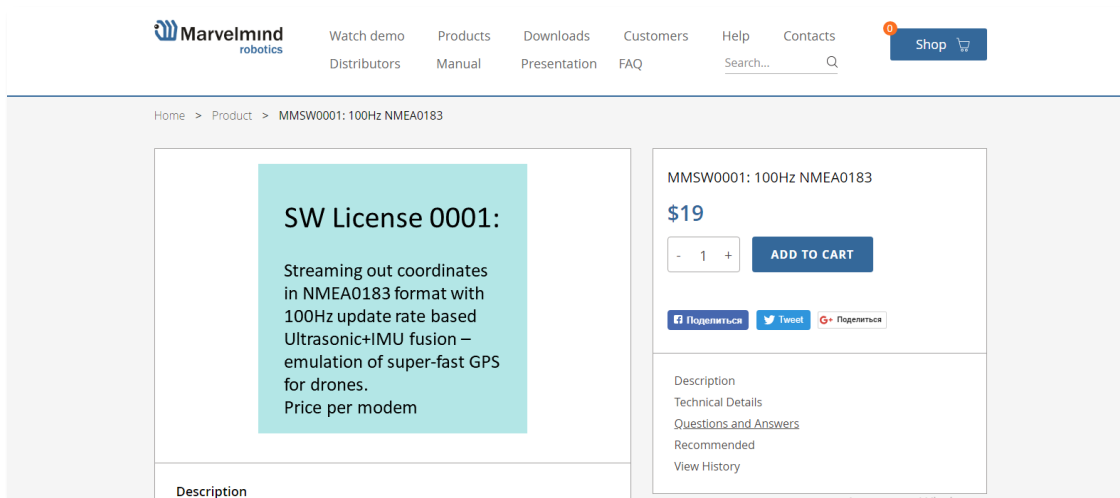

- Make an order.
- Pay for the feature (via PayPal or other methods).
- Order the feature via the Dashboard by providing device's CPU ID or send us email with the device's CPU ID:
 - Open Dashboard SW
 - Connect the device you need to order a license to the Dashboard via USB

- Go to Licenses → View/activate licenses

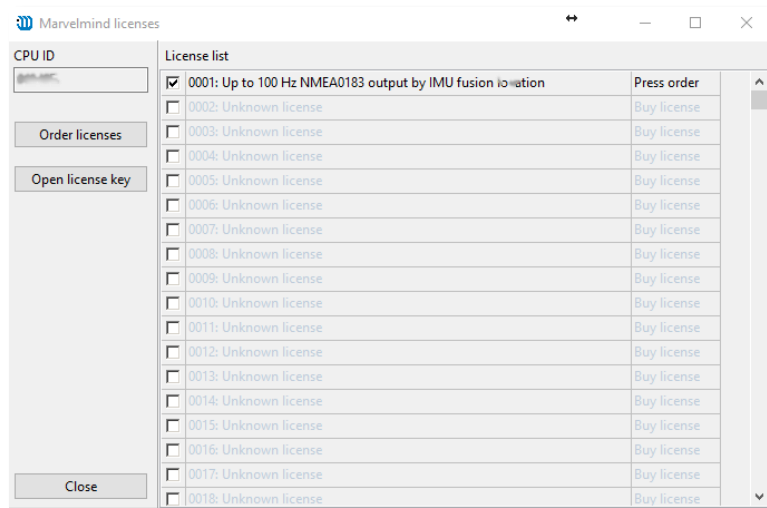

- Choose the licenses which you have purchased.
- Press Order licenses.
- Dashboard will generate a text

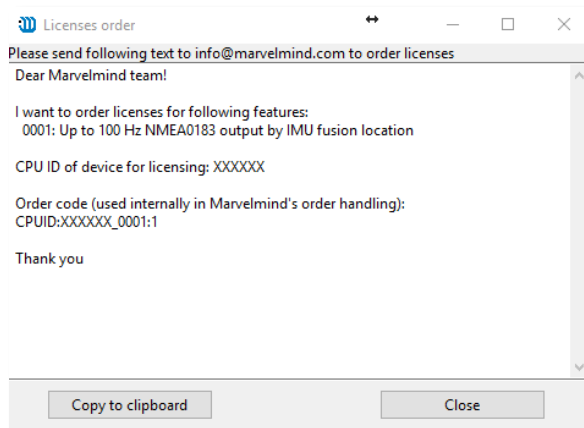

- Send generated text to info@marvelmind.com
- We will generate the license key and send to you via email
- Place the license key into Dashboard/Licenses folder:
- Connect device to the Dashboard via USB
- Go to **Licenses** → **View/activate licenses**
- Choose "Open license key"
- Choose the license file (be careful if you have licenses for multiple devices, check CPU ID carefully)
- The features become activated in the Dashboard.

9.1.2. License MMSW0005 designation in Dashboard

MMSW0005 – one of the most significant license for Marvelmind SW.

Learn more: [SW Pack 7.0/7.1 Release Notes](#)

In the previous version of SW (older than 7.200), when license been activated version of SW changed from 7.0xx to 7.1xx.

From version 7.200 activated license shows in Dashboard as “L”

- If license MMSW0005 activated for all devices, it shows L in the window capture of Dashboard, next to version of Dashboard:

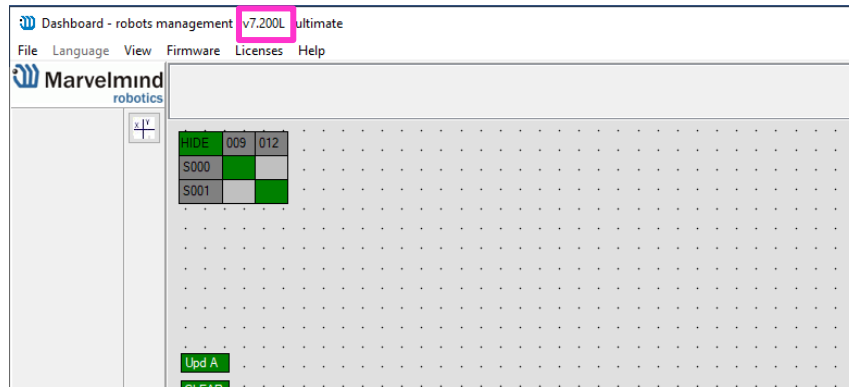

- If license not activated for one or more beacons in a system, it will be reported in the right information window:



- And “L” will be shown next to version of firmware of each beacon with activated license:

Read all		Write all		Write changes		Cancel changes	
CPU ID	Copy to clipboard	09343A					
Firmware version		v7.200L Super-Beacon					
Power save functions		enabled / not frozen					
Hedgehog mode		disabled					
Supply voltage, V (3.50..4.30)		4.05					
Time from reset, h:m:s		00:07:42 / 18.30.01 / 0					
RSSI from modem, dBm		-30					

9.2. Islands feature

To use Islands Feature license MMSW0007 needed and Marvelmind SW from version 7.200 and latest.

This feature allows to make different submaps for each hedge.

How to do this (it's example with 2 submaps. 4 stationary beacons and 2 mobile beacons):

- Awake all 4 stationary beacons (just Click on it with Left mouse button):

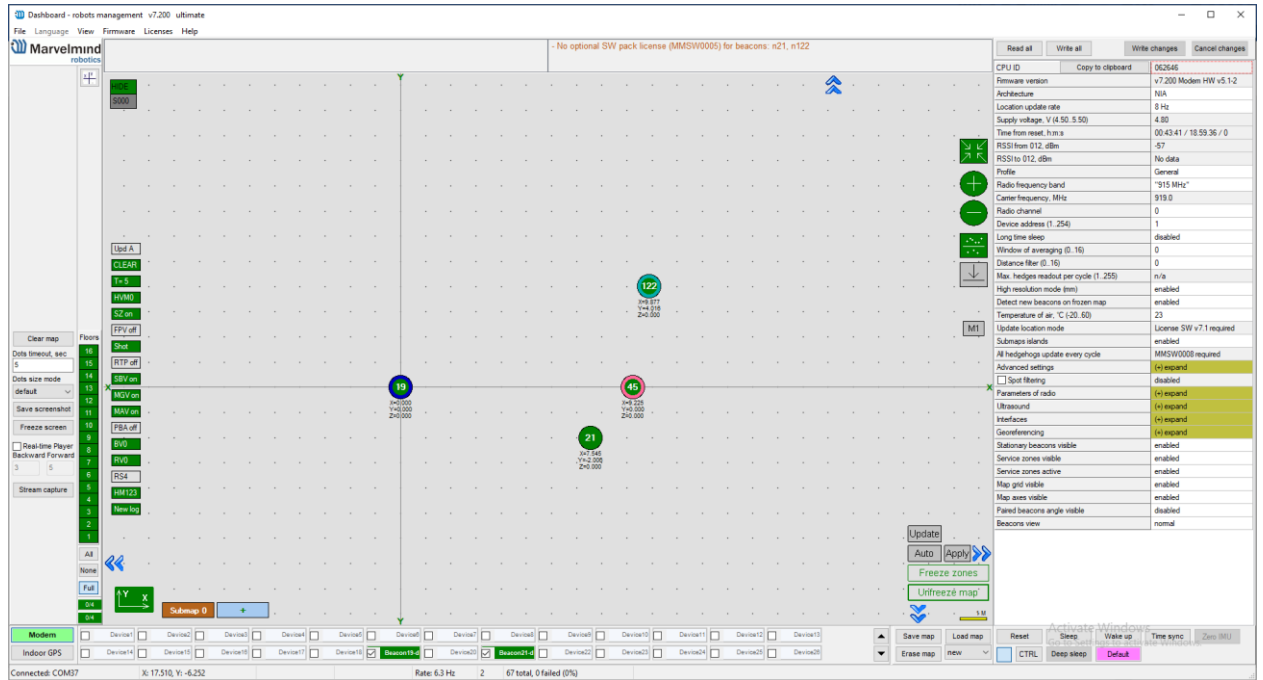

- Leave 2 of them on Submap0 and move another 2 on Submap1. You will get 2 separate submaps..

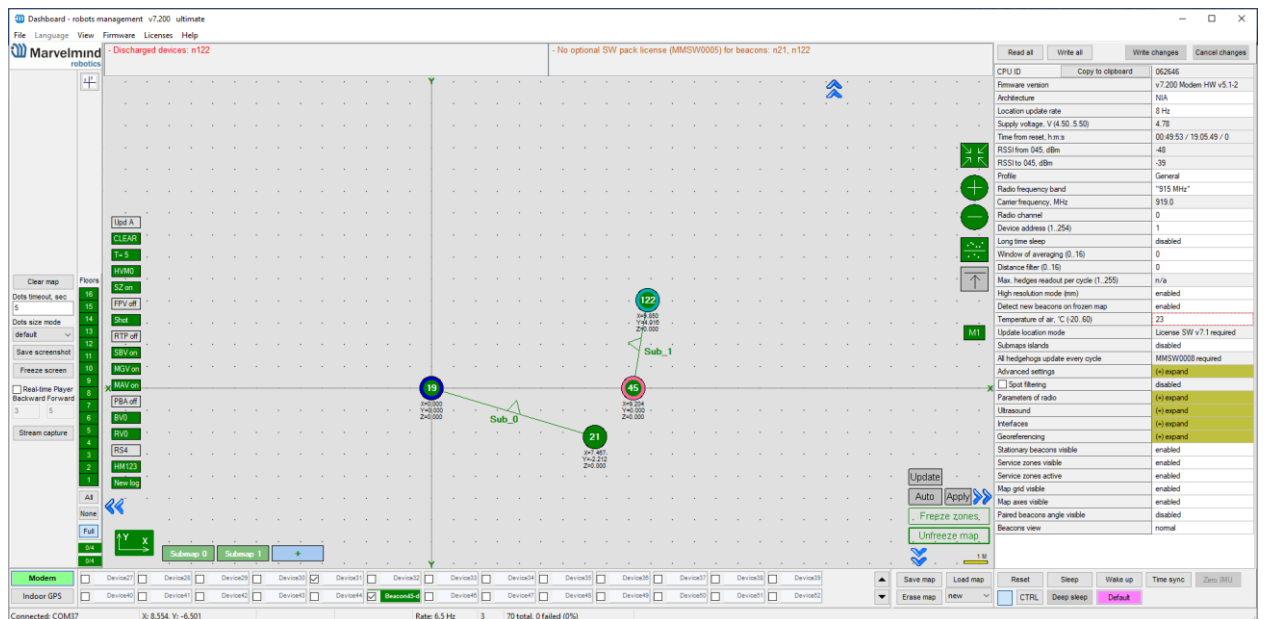

- Move submaps as you wish. Use CTRL and mouse roll to rotate Submap.

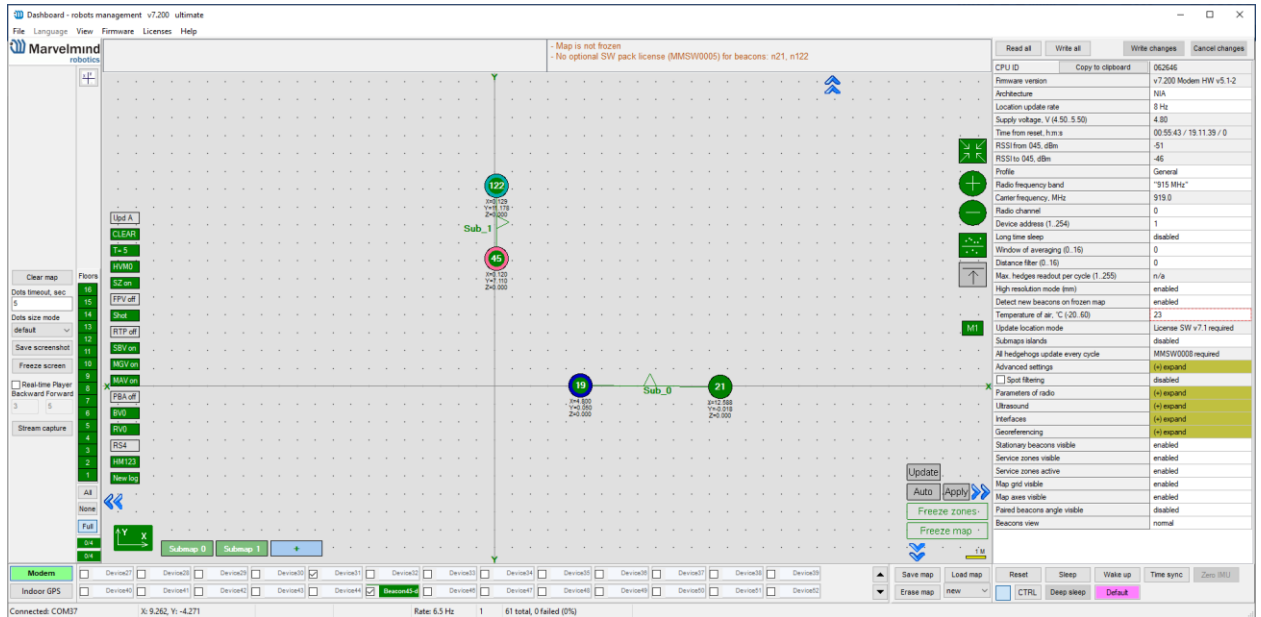

- Awake mobile beacons. It will appear in a map.

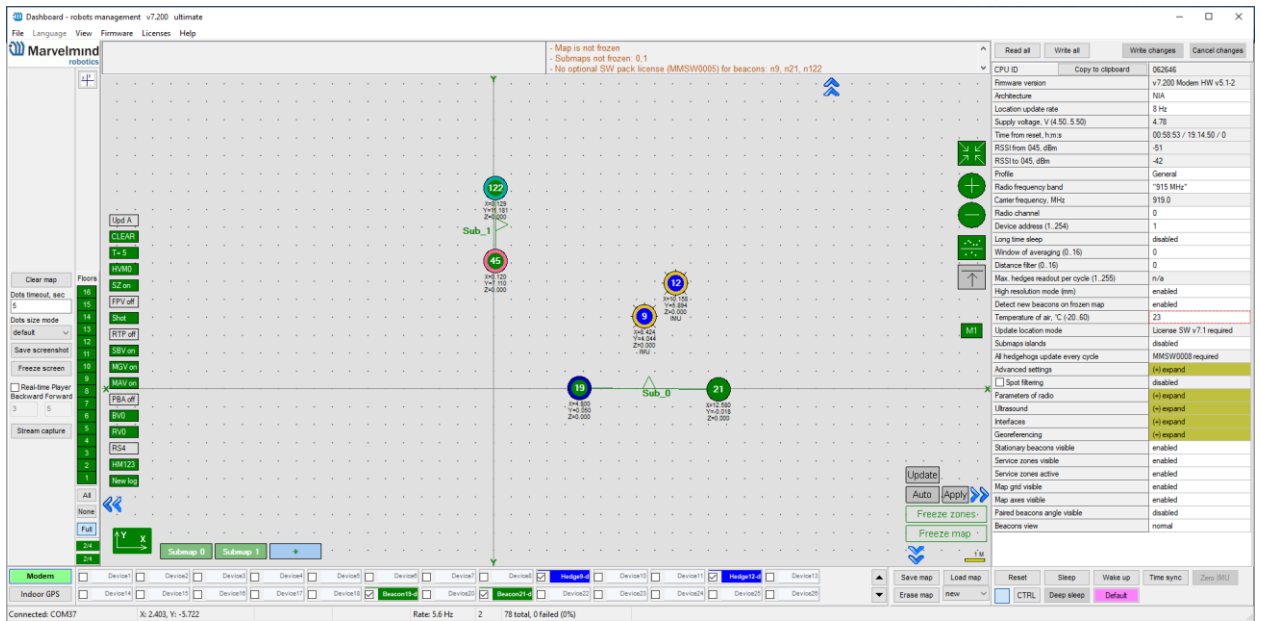

- If license activated correctly, with selected modem you can select the “islands” mode and assign mobile beacons to submaps.
- Enable Submaps islands

Max. hedges readout per cycle (1..255)	n/a
High resolution mode (mm)	enabled
Detect new beacons on frozen map	enabled
Temperature of air, °C (-20..60)	23
Update location mode	License SW v7.1 required
Submaps islands	disabled
All hedgehogs update every cycle	MMSW0008 required
Advanced settings	(+) expand
<input type="checkbox"/> Spot filtering	disabled
Parameters of radio	(+) expand
Ultrasound	(+) expand
Interfaces	(+) expand
Georeferencing	(+) expand

- When Submaps Islands mode enabled, you can choose submap for each beacon

The screenshot shows the Marvelmind robotics management interface. The main window displays a 2D map with several beacons (represented by colored circles) and two submaps, 'Sub_0' and 'Sub_1', overlaid on the map. A settings panel on the right side of the interface is open, showing various configuration options. The 'Submaps islands' option is highlighted in green, indicating it is enabled. Other settings include 'Max. hedges readout per cycle' (n/a), 'High resolution mode' (enabled), 'Temperature of air' (23), and 'Update location mode' (License SW v7.1 required). The bottom of the interface shows a list of devices and their status, along with a status bar at the very bottom indicating 'Connected: COM37' and 'X: 4.871, Y: -9.605'.

- Now mobile beacon 12 will be work with Sub1 and beacon 9 will be work with Sub0.

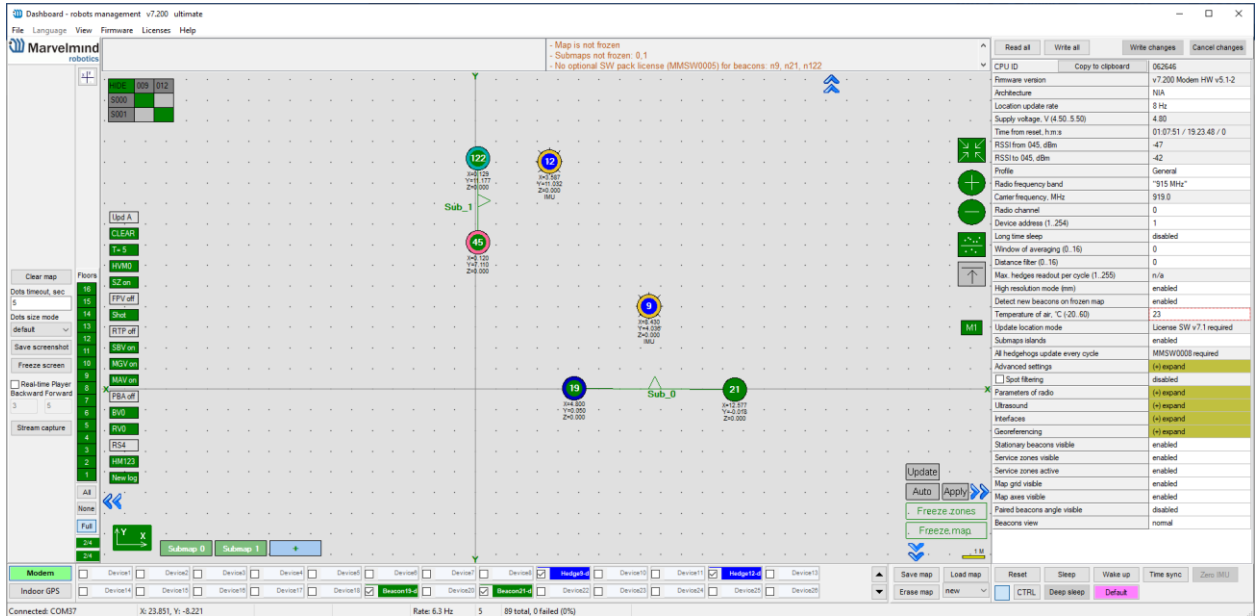

- Freeze each submap and Freeze map.

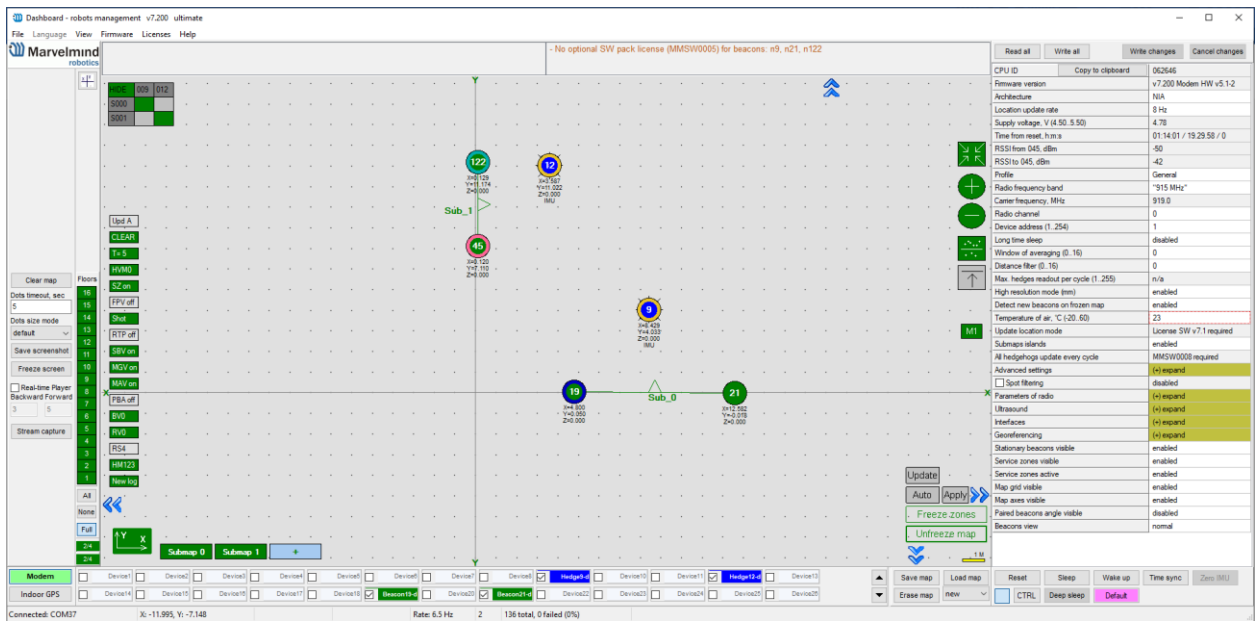

- Islands settings completed.

9.3. Dashboard Monitoring Mode

Dashboard Monitoring Mode is a mode which allows you to observe tracking without any ability to control and modify the system.

Now, you can divide permissions between users for avoidance of accidental change of any settings and corrupting the system. That is something like safety button.

This is the first version of Dashboard Monitoring Mode. New functionality and appearance may come with future SW updates

How to enable Dashboard Monitoring Mode:

- Click on the “Stream capture” button (It will be renamed in future updates into “Dashboard Monitoring Mode”)

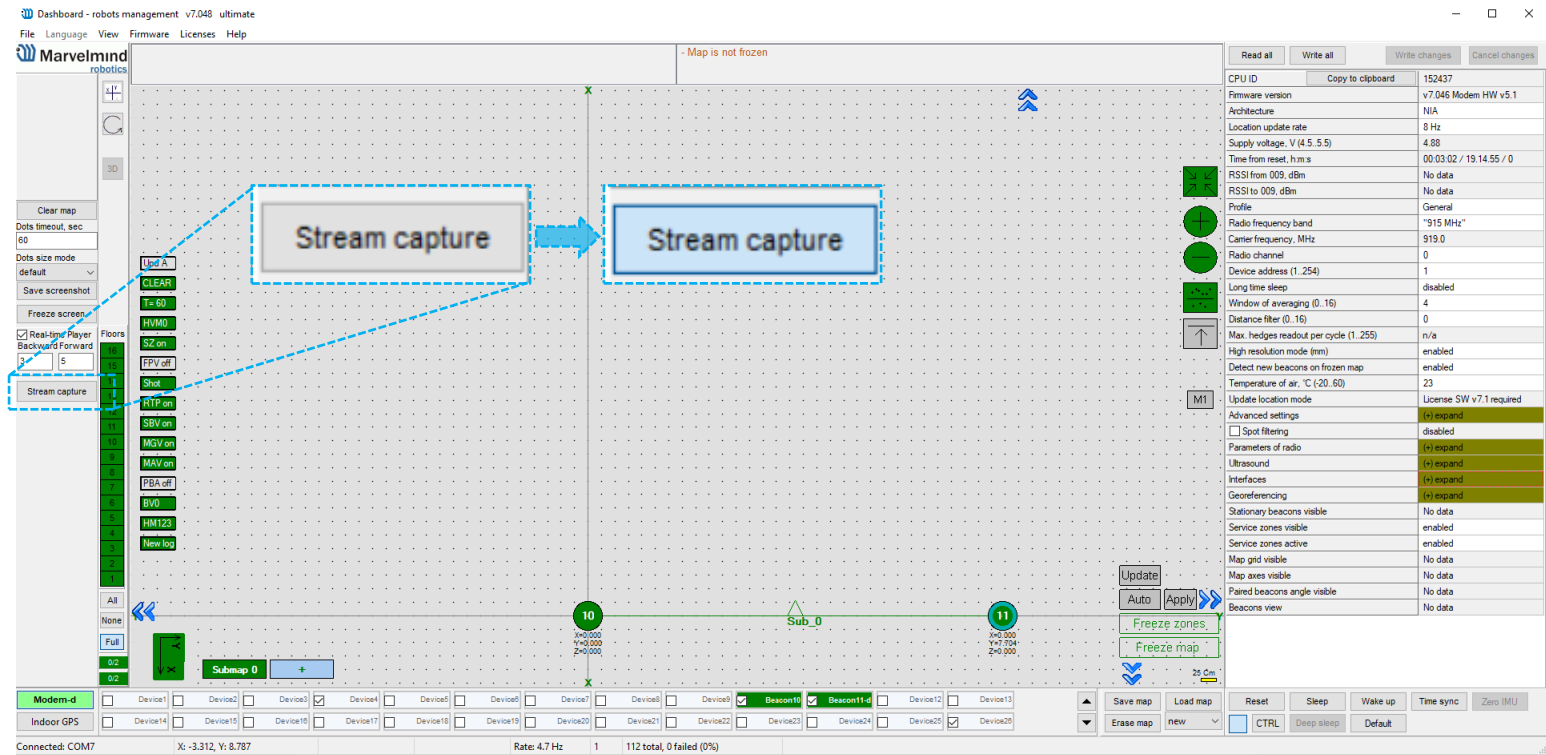

- If you try to change settings while Dashboard Monitoring Mode is on, the notification window will appear:

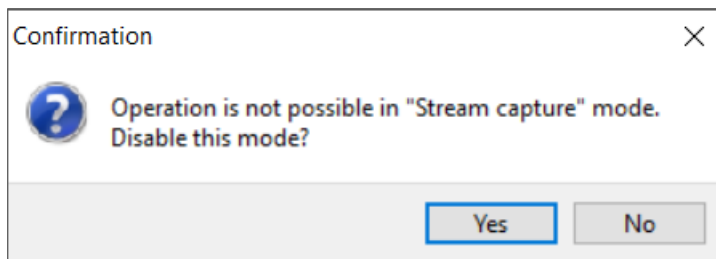

9.4. Microphone settings

9.4.1. Specific Marvelmind devices

For different devices should be turned on different mics.

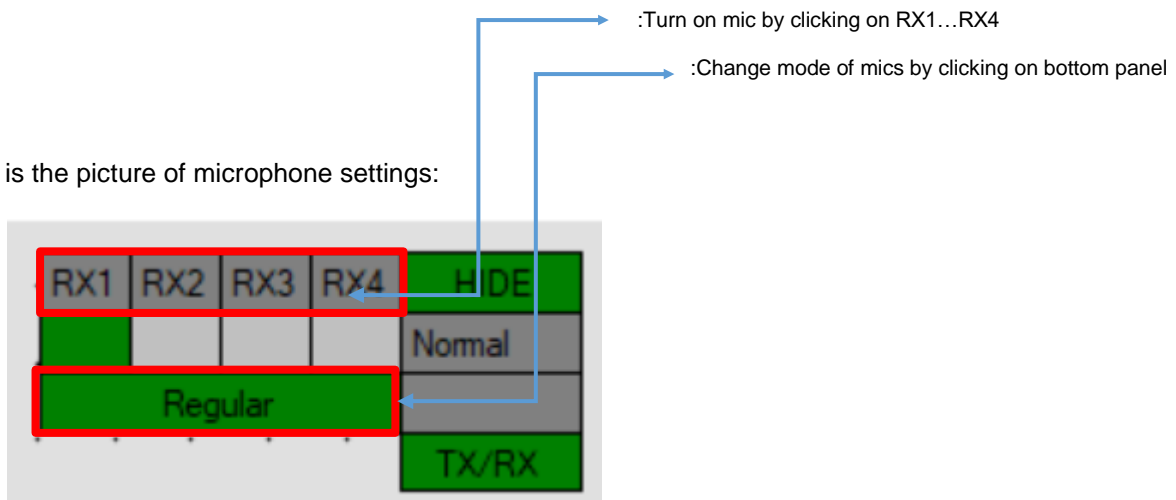

Below is the picture of microphone settings:

Below are presented settings for different Marvelmind devices:

Badge:

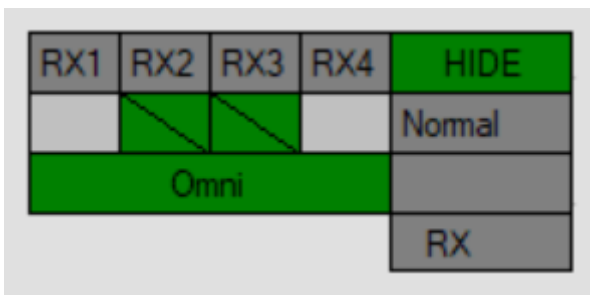

Jacket:

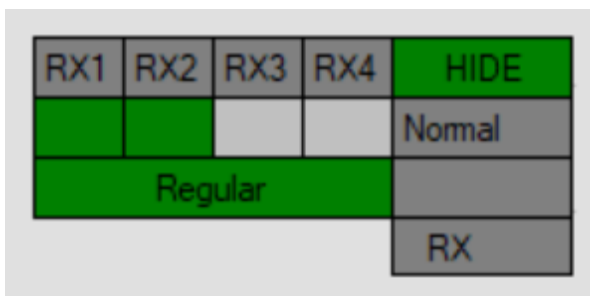

Helmet:

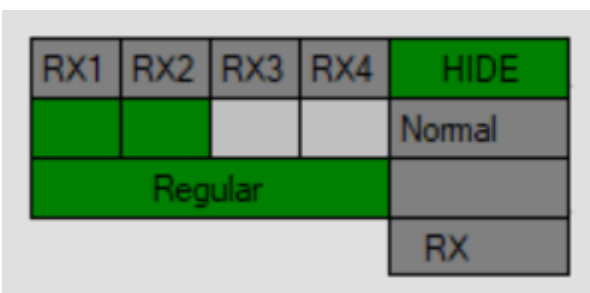

9.4.2. Separate Omni-microphone

You can additionally purchase an Omni-microphone for improved performance.

! Before buying inform on which device you want to use the Omni-microphone.

On Super-Beacon Omni-mic works in Omni mode on RX3 and RX4. On Super-Beacon-2 Omni-mic works in Omni mode on RX2 and RX3.

Below is location of different mics on the Omni-mic:



Example of correct settings for Omni-mic on Super-Beacon-2 in Omni mode:

RX1	RX2	RX3	RX4	HIDE
				Normal
Omni				
				RX

Also, if you want to use specific microphone on Omni-mic you can switch mode to Stereo and turn on one of the pairs and even one of the mics in one pair.

To turn on of the pairs on Omni-mic click on the box RX2...RX4, depends on which Super-Beacon you have and which pair you want to have turned on:

RX1	RX2	RX3	RX4	HIDE
				Normal
Stereo				
				TX/RX

To turn on one of the mic in a specific pair press on a specific box below RX2...RX4 with CTRL:

RX1	RX2	RX3	RX4	HIDE
				Normal
Stereo 1				
				TX/RX

9.5. Restart if modem is disconnected

This feature using to reset beacon when it lost connection with modem.

Follow this steps to switch on this feature.

9.5.1.Connect beacon via USB or radio and expand Misc. settings in settings bar:

Misc. settings	(-) collapse
Sleep by timeout	60 sec no connection
Sleep with external power	60 sec no connection
Status LED	enabled
Restart if modem is disconnected	disabled
Timeout of restart without modem, sec (5..250)	n/a

9.5.2.Enable restart modem is disconnected option:

Misc. settings	(-) collapse
Sleep by timeout	60 sec no connection
Sleep with external power	60 sec no connection
Status LED	enabled
Restart if modem is disconnected	enabled
Timeout of restart without modem, sec (5..250)	10

9.5.3.Put in a timeout of restart without mode in sec:

Misc. settings	(-) collapse
Sleep by timeout	60 sec no connection
Sleep with external power	60 sec no connection
Status LED	enabled
Restart if modem is disconnected	enabled
Timeout of restart without modem, sec (5..250)	10

9.5.4.Restart if modem is disconnected feature settings completed.

9.6. Geofencing zones

Geofencing zones is a subset of zones which can be created to prevent people crossing dangerous zones. Zones violations leads to alarm and will be written into CSV-file.

How to create geofencing zone:

- Unfreeze map, submap may be frozen

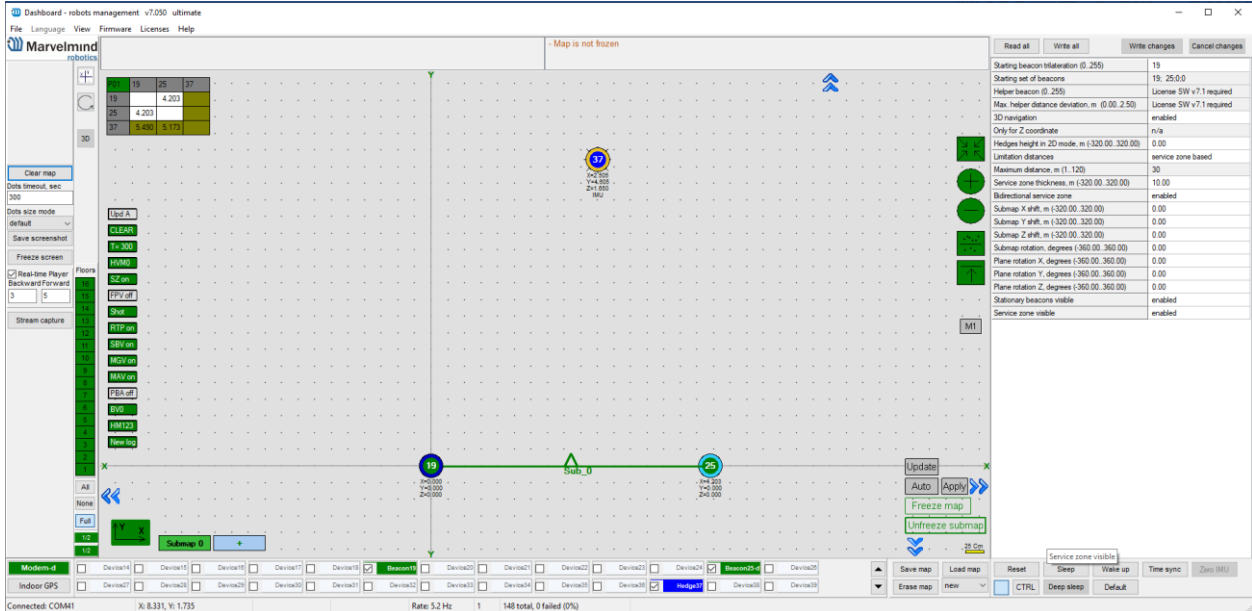

- Right click on the map -> Zones setup

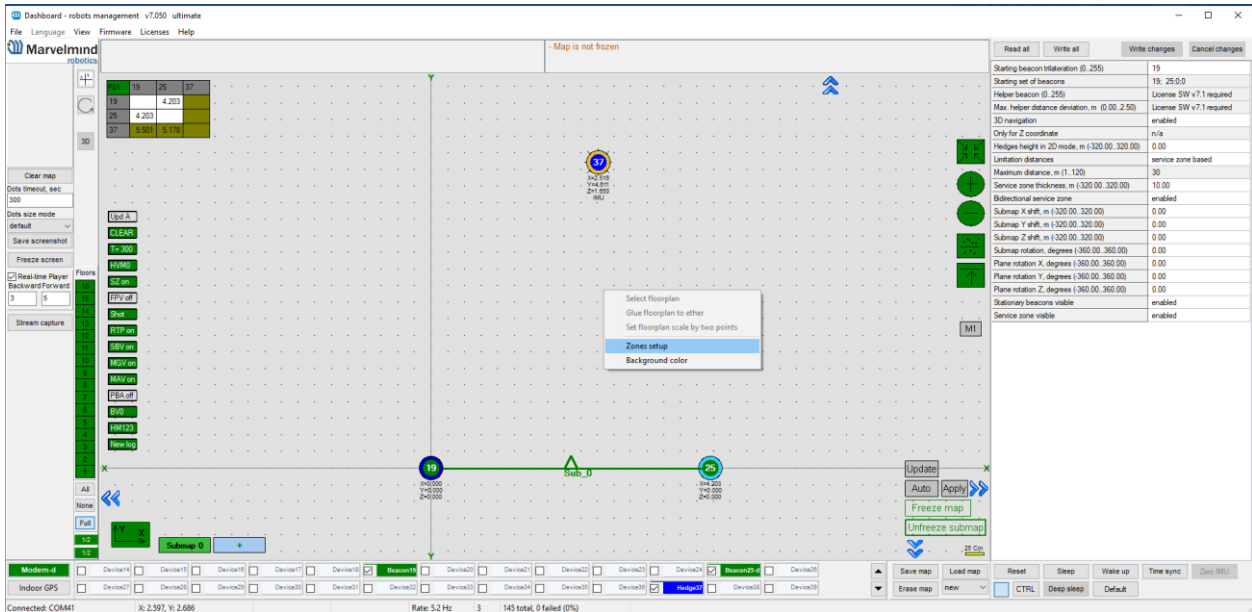

- Left Click on Zone type and choose Geofencing

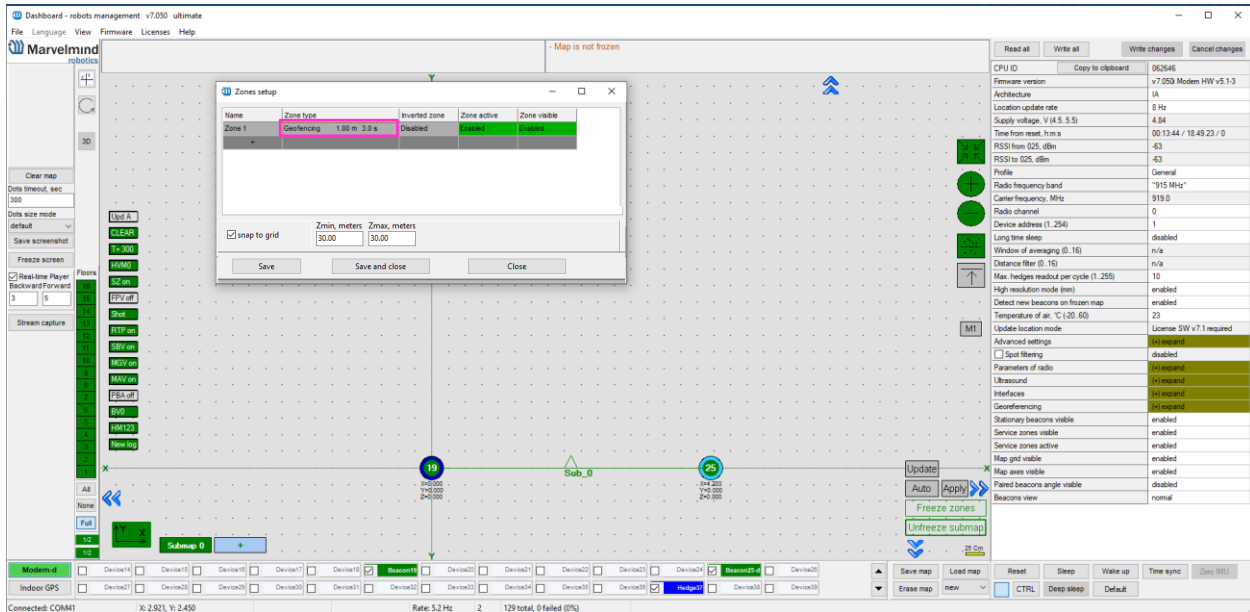

- Create a zone using **Shift + Left Click** and clicking on map, click on point removes it

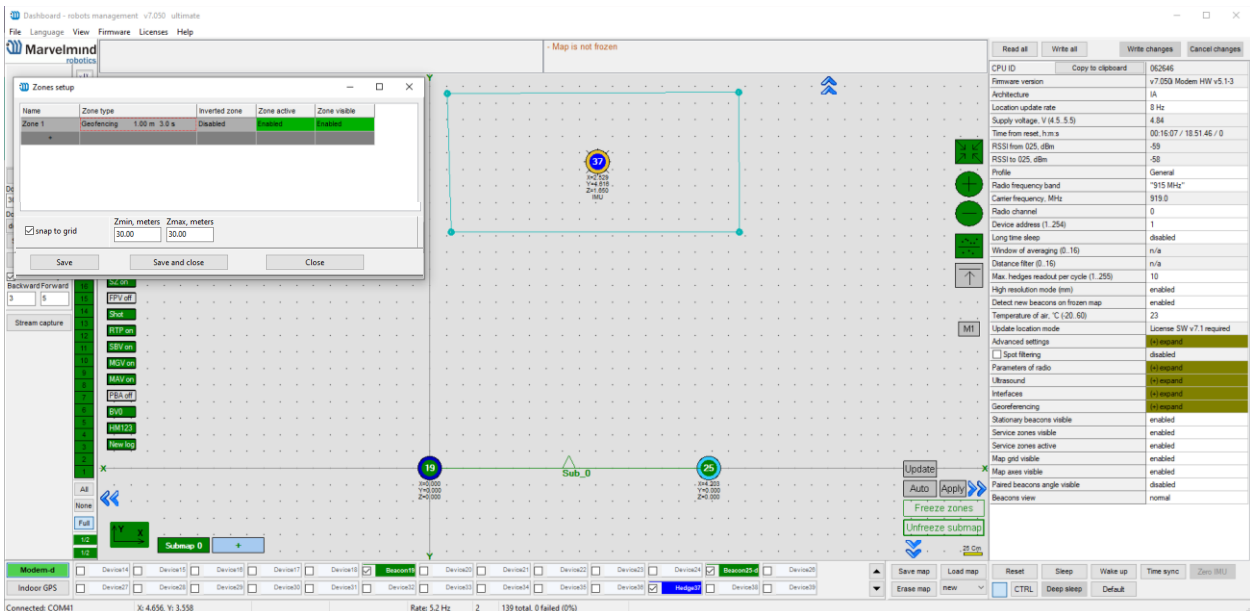

- You can tune zone with entering distance and entering time. If zone created, press **Save and close** to save zone

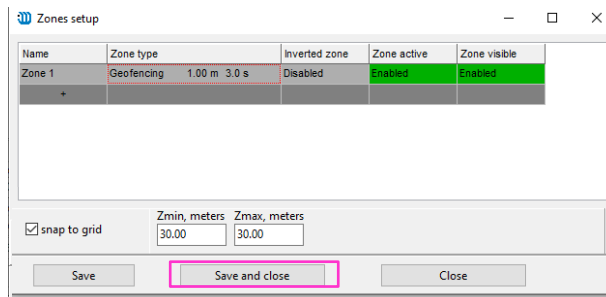

- After you Save and Close Zones setup window, zone turn to grey. Freeze map

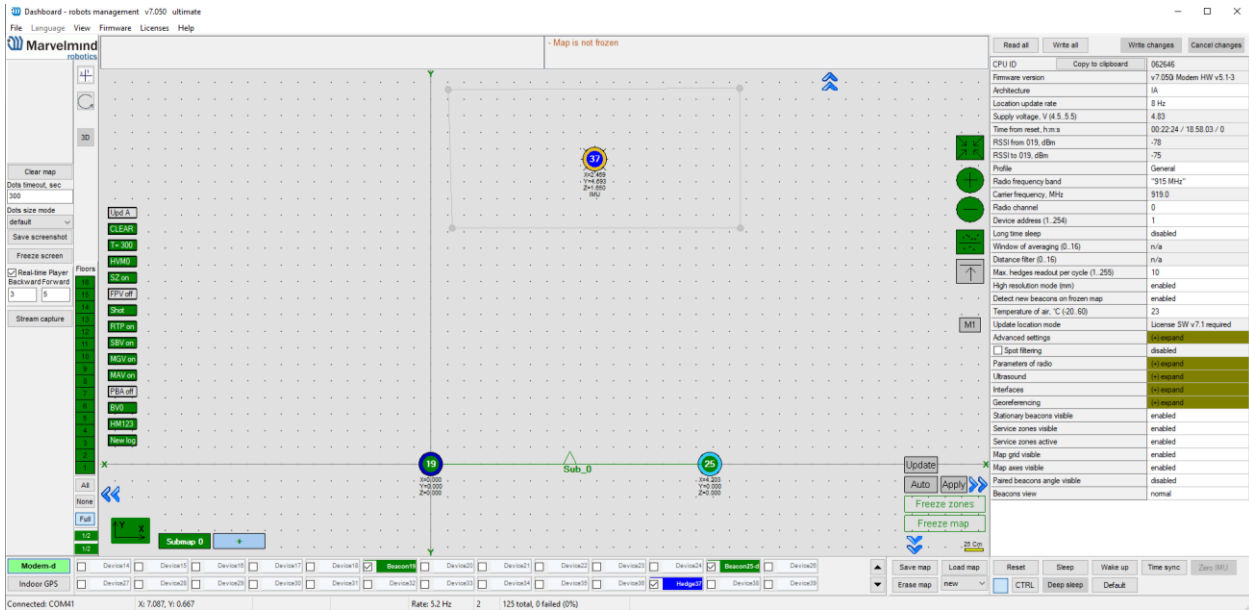

- Zone created and ready to work. If mobile beacon crosses zone for tuned distance and tuned time, that violation will be recorded to CSV-file, and hedgehog will be colored red in the Dashboard

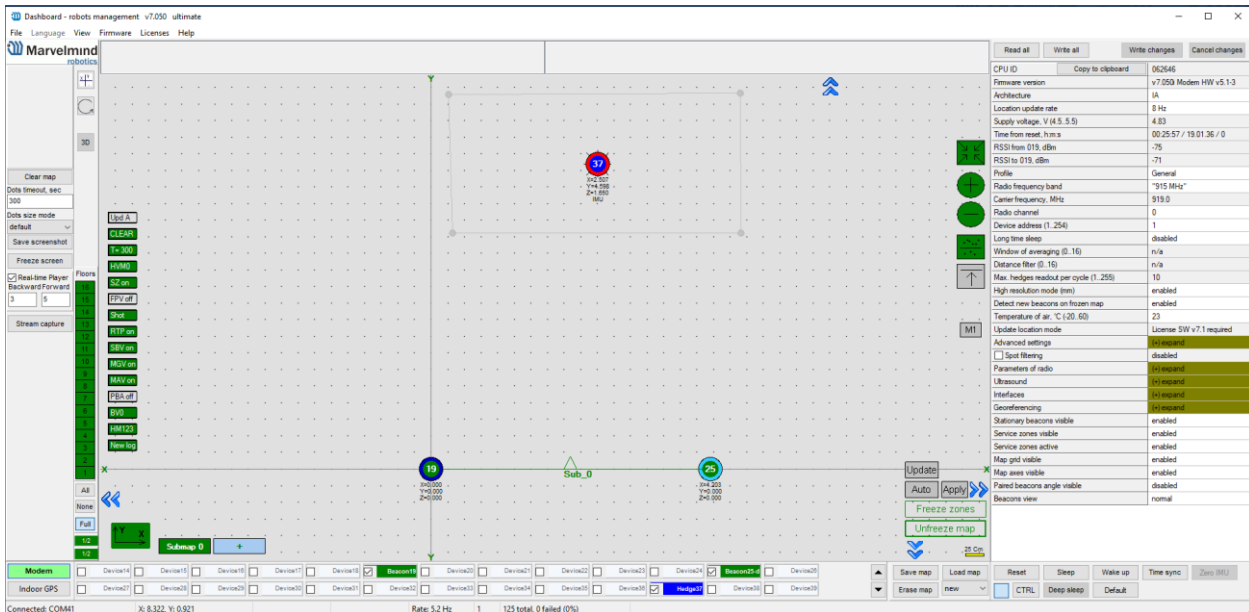

9.7. Geofencing alarm (MMSW0006 license)

[SW License MMSW0006](#) activates support for a dedicated pin for geofencing zone violation. Instead of reading the stream of location data in the protocol, it is now possible to have just a pin from the 4X4 of Super-Beacon or pins on the modem or internal pins in the Mini-RX to be automatically switched to “0” or “1”, on every time reset, when the geofencing zone rules are violated.

SW License 0006:

Dedicated pin for geofencing alarm

Price per beacon or modem.

Supported hardware:

- Super-Beacon
- Modem v5.1
- Mini-RX

Follow instruction bellow to use this feature:

9.7.1. Connect alarm to your device according to scheme:

9.7.1.1. Geofencing pin scheme for Super-Beacon (when license activated SPI will not be available):

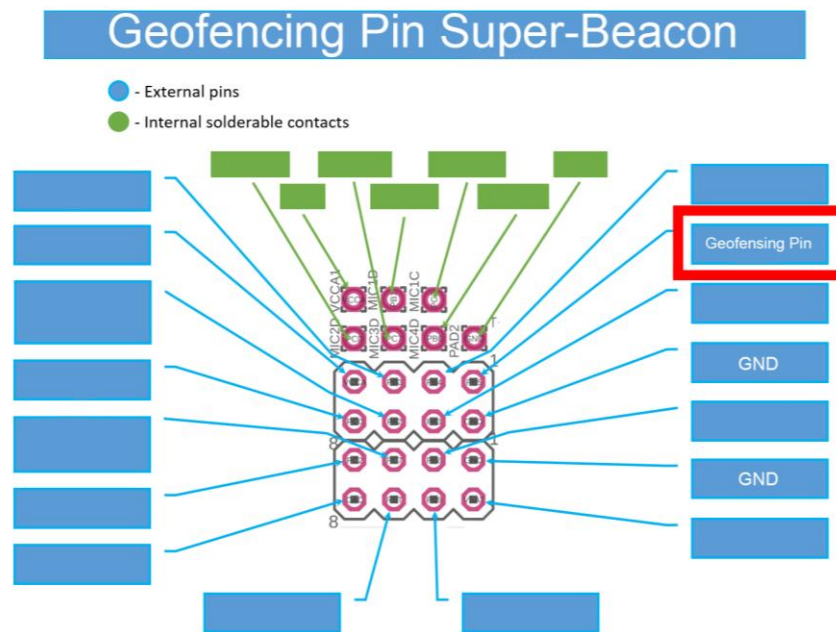

9.7.1.2. Geofencing pin scheme for Modem HW v5.1:

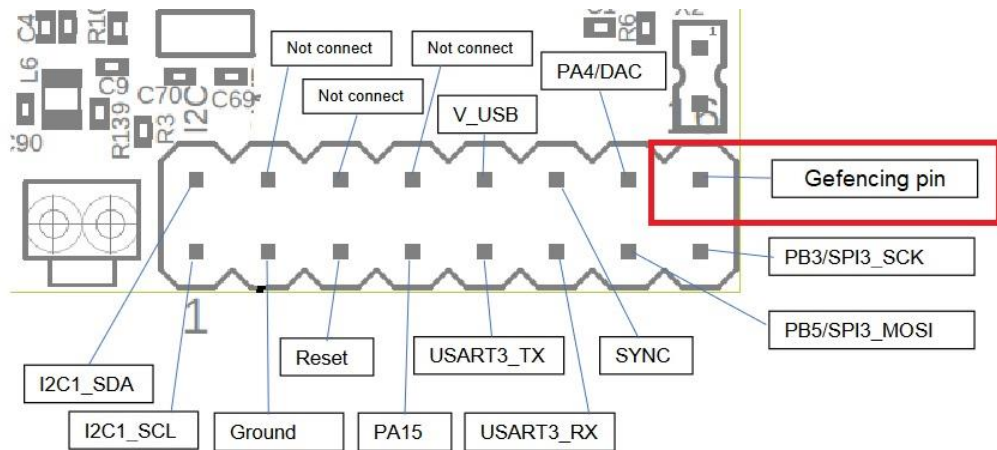

9.7.1.3. Geofencing pin scheme for Mini-RX:

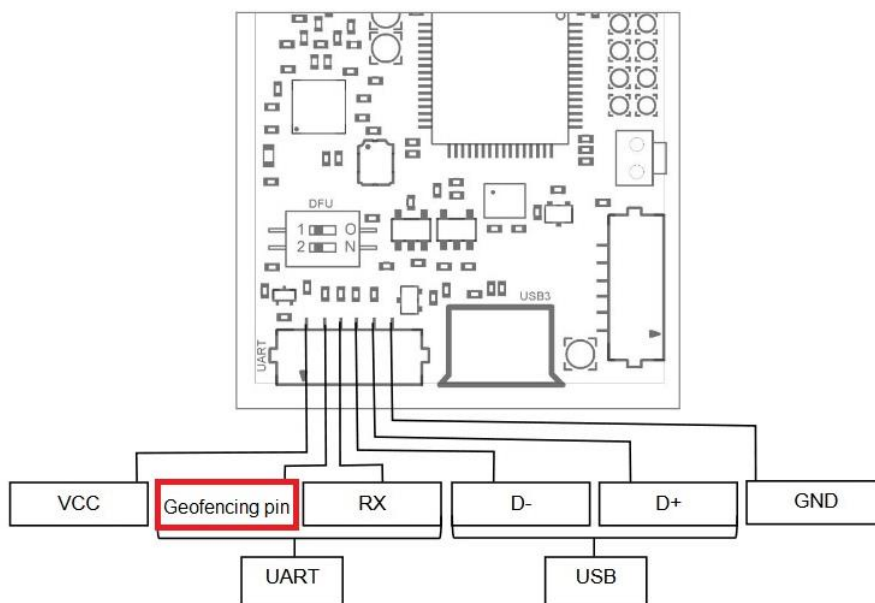

9.7.2. Connect beacon via dashboard or radio and expand Interfaces in a settings bar:

Interfaces	(-) collapse
UART speed, bps	500000
Streaming output	USB+UART
Protocol on UART/USB output	Marvelmind
PB4 pin function	SPI MISO
Quality and extended location data	disabled
Alarm pin function	None
Alarm pin mode	n/a
Streaming mode	License SW v7.1 required
Debugging data	disabled
SPI data output	disabled

9.7.3.Switch on Alarm pin function parameter:

Interfaces	(-) collapse
UART speed, bps	500000
Streaming output	USB+UART
Protocol on UART/USB output	Marvelmind
PB4 pin function	SPI MISO
Quality and extended location data	disabled
Alarm pin function	Geofencing alarm
Alarm pin mode	Low level on alarm
Streaming mode	License SW v7.1 required
Debugging data	disabled
SPI data output	disabled

9.7.4.Choose needed alarm pin mode according to a bellow table:

Alarm pin mode	Pin state with alarm	Pin state without alarm
Low level alarm	+3.3V	Z state
High level alarm	0.0V	Z state

Interfaces	(-) collapse
UART speed, bps	500000
Streaming output	USB+UART
Protocol on UART/USB output	Marvelmind
PB4 pin function	SPI MISO
Quality and extended location data	disabled
Alarm pin function	Geofencing alarm
Alarm pin mode	Low level on alarm
Streaming mode	License SW v7.1 required
Debugging data	disabled
SPI data output	disabled

9.7.5.Geofencing alarm settings completed.

9.8. PPS (Pulse per second) signal

This feature using to get a pulse signal from Super-Beacon every second. Works with Super-Beacon in NIA only.

To switch on PPS, follow instruction bellow:

9.8.1. Connect a speaker to Super-Beacon 4x4 pinout according to scheme:

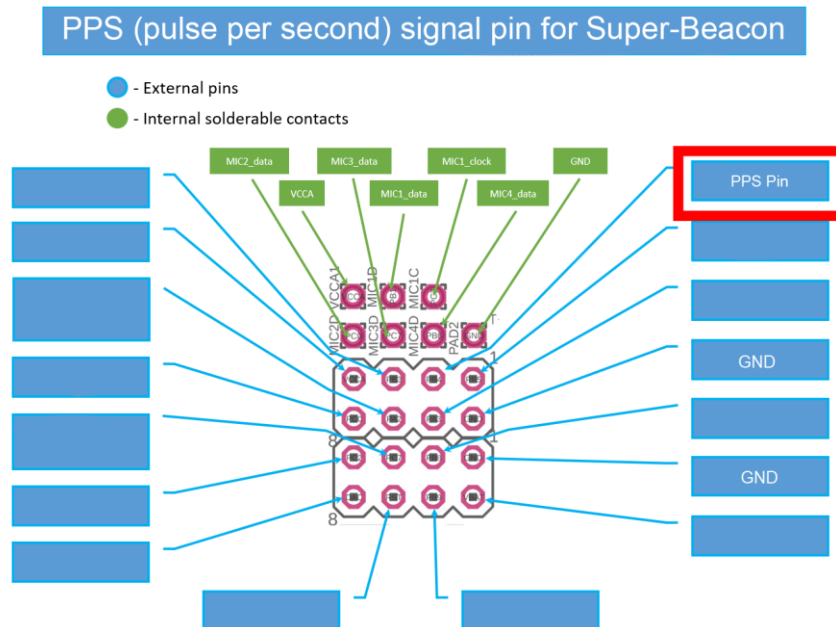

9.8.2. Connect beacon via dashboard or radio and expand Interfaces in a settings bar:

Interfaces	(-) collapse
UART speed, bps	500000
Streaming output	USB+UART
Protocol on UART/USB output	Marvelmind
PB4 pin function	SPI MISO
Quality and extended location data	disabled
Alarm pin function	None
Alarm pin mode	n/a
Streaming mode	License SW v7.1 required
Debugging data	disabled
SPI data output	disabled

9.8.3. Choose PPS output in PB\$ pin function option:

Interfaces	(-) collapse
UART speed, bps	500000
Streaming output	USB+UART
Protocol on UART/USB output	Marvelmind
PB4 pin function	PPS output
Quality and extended location data	disabled
Alarm pin function	None
Alarm pin mode	n/a
Streaming mode	License SW v7.1 required
Debugging data	disabled
SPI data output	disabled

9.8.4. PPS pin settings completed.

9.9. Floors feature (FN0011)

9.9.1. The general view

Floor feature allows to build complicated multi-level maps. Every submap correspond some height, height corresponds to floors.

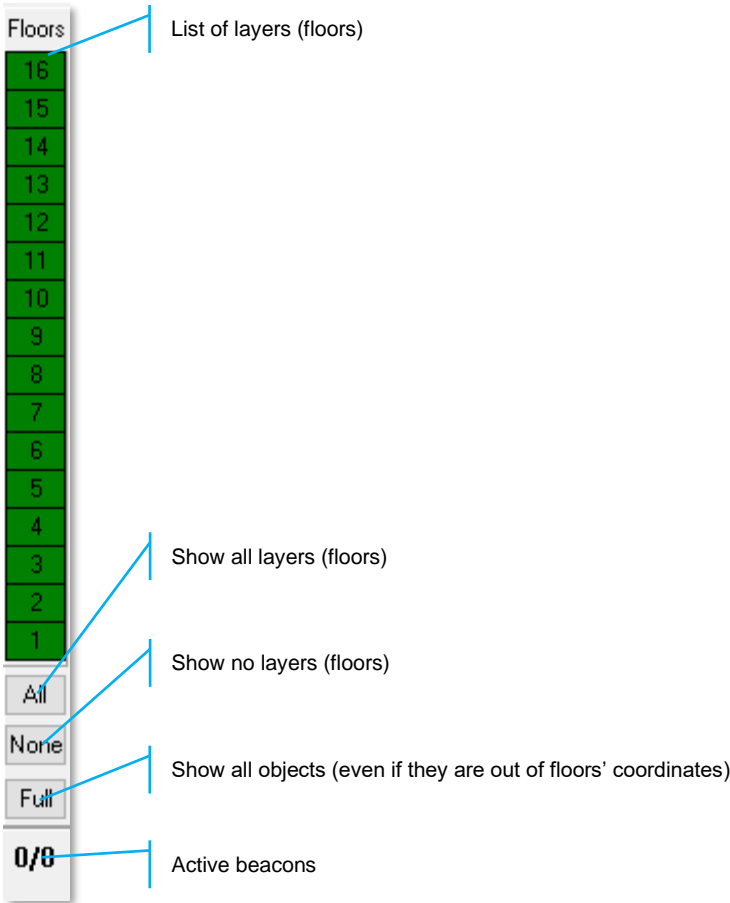

9.9.2. Floor Settings

- Every floor has its own adjustable height and its own floor plan

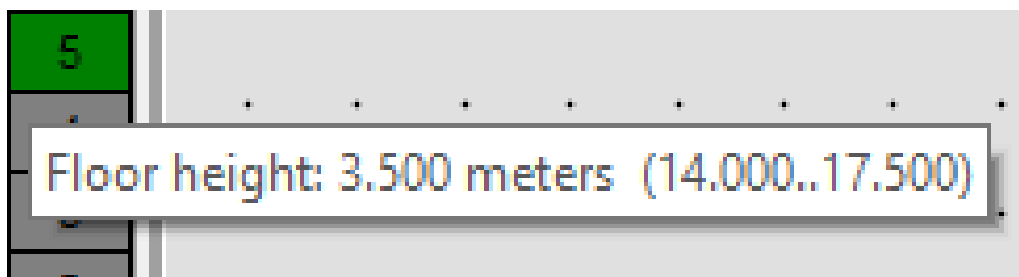

- Right click on the floor area to see an additional menu. There you can change floor's height. You can also insert your floorplan for that floor (.png, .jpeg, .bmp, .tiff)

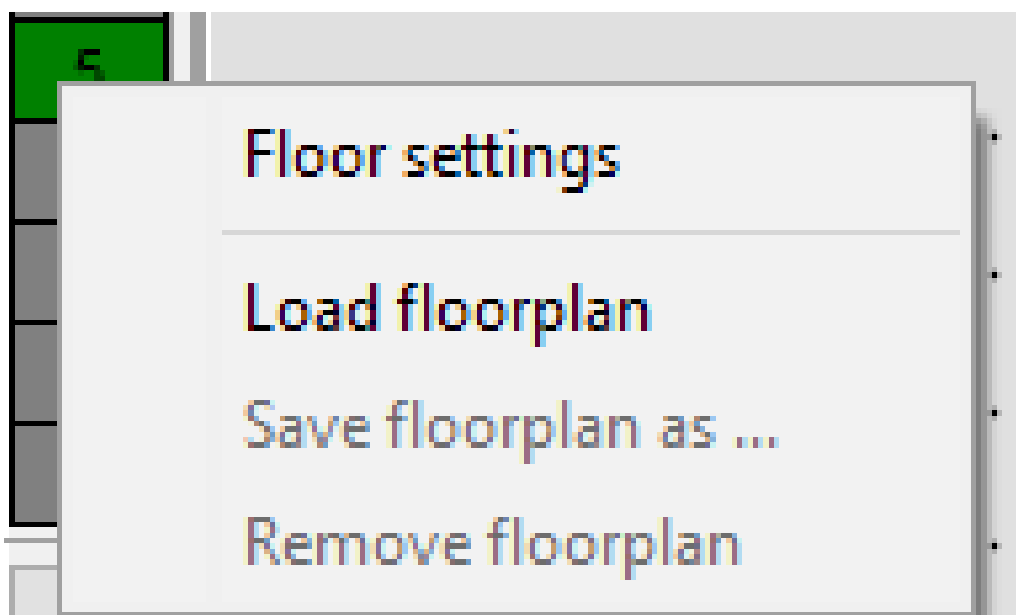

- Floor 4 and 5 are enabled:

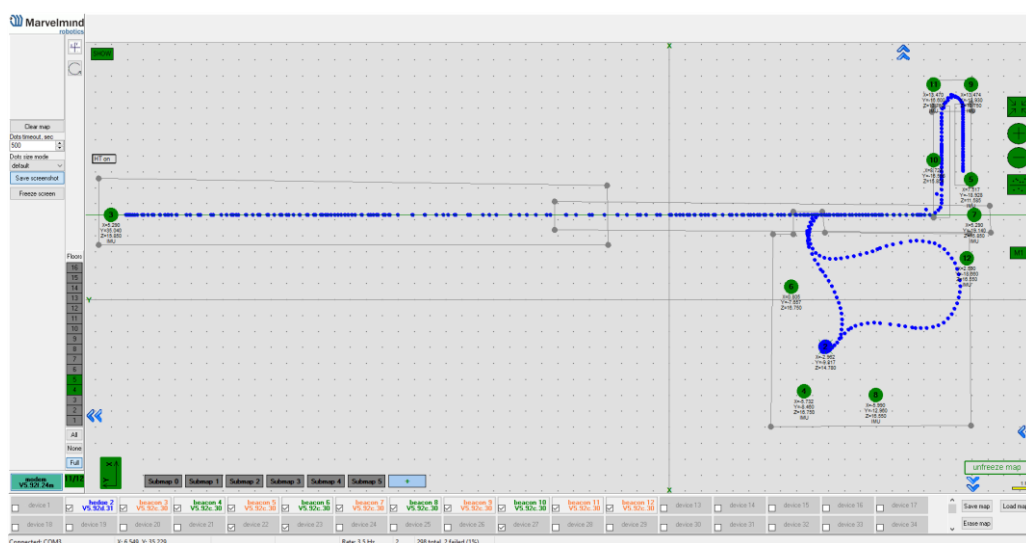

- Floor 5 is enabled:

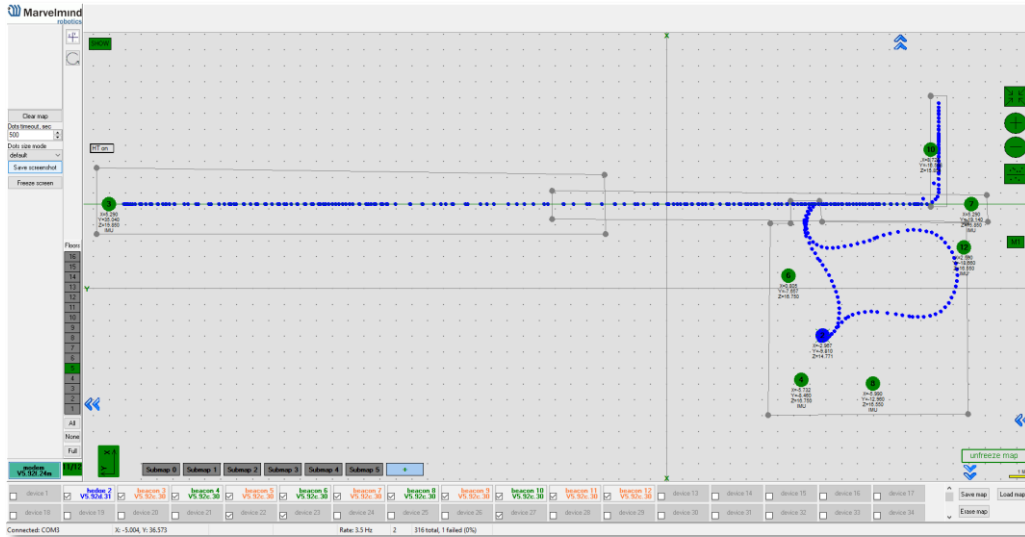

- Floor 4 is enabled:

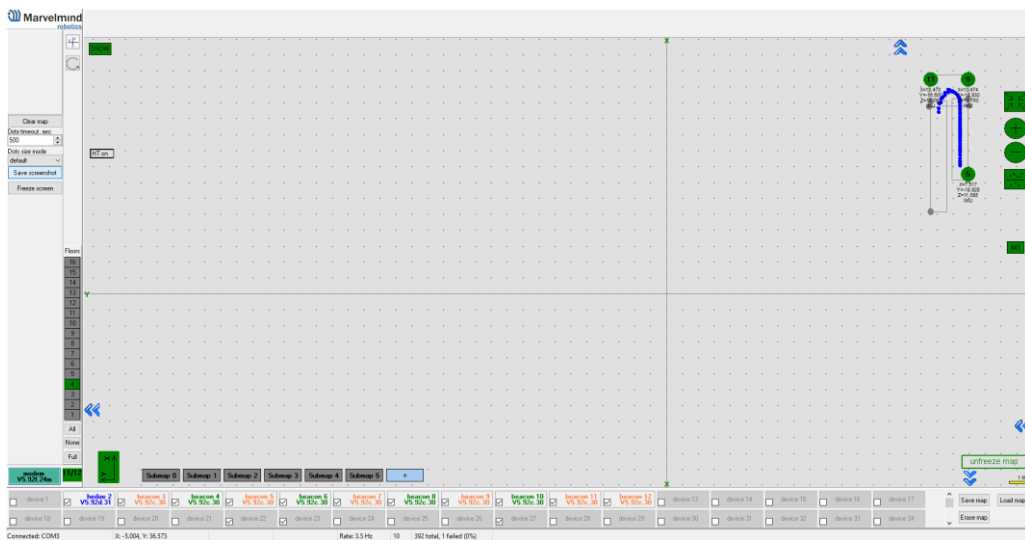

9.9.3. Map layers

The map consists of several layers. Each layer can be attached to other.

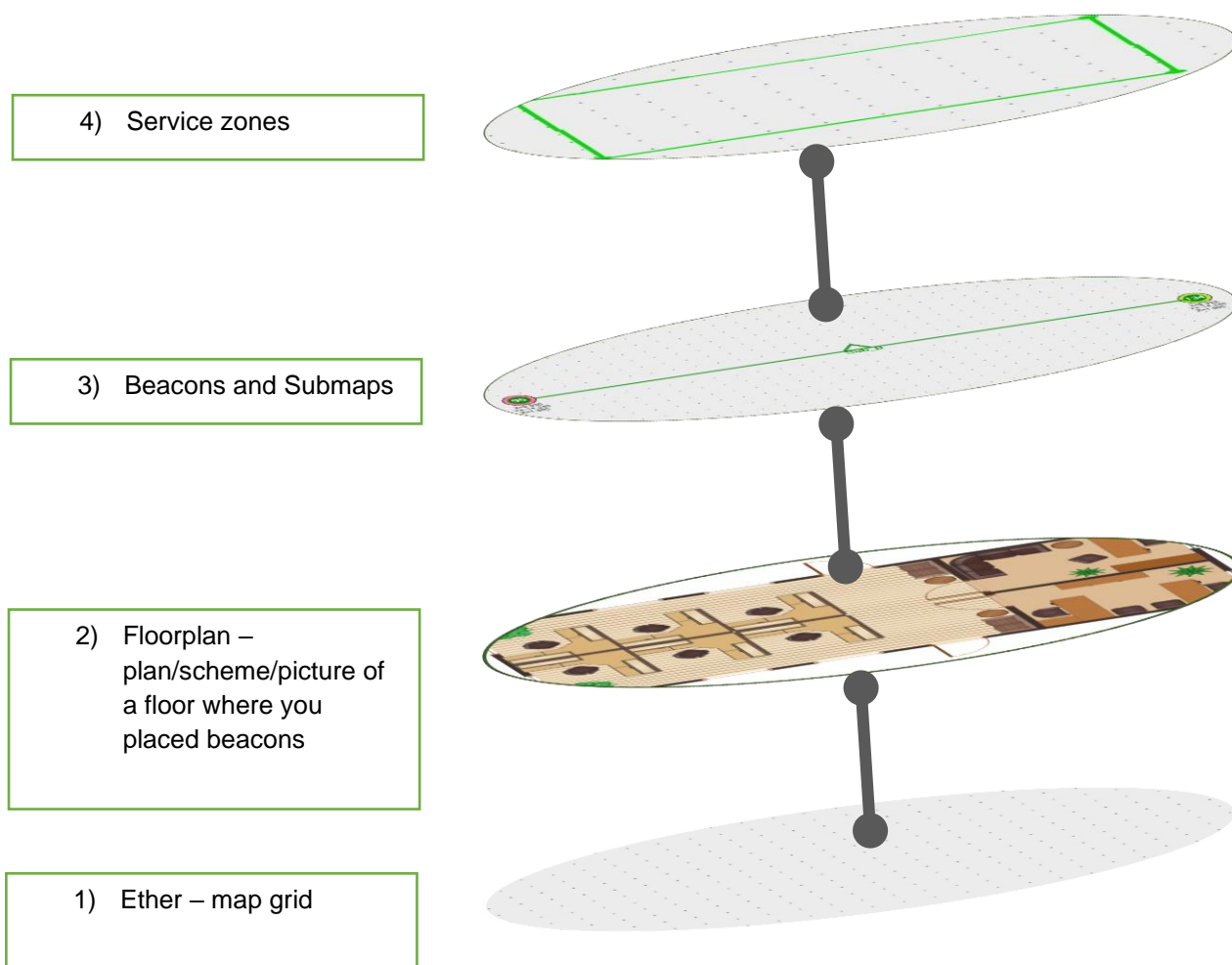

9.10. Floorplan feature

This chapter describes how to load and use a floorplan in Dashboard.

9.10.1. Loading the Floorplan (Substrate)

To load a floorplan:

- Right click on the floor

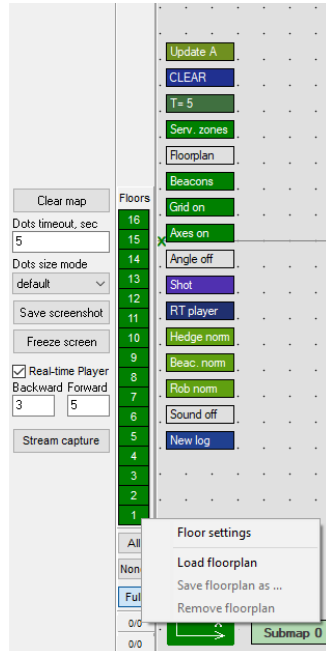

- Load floorplan -> Choose file (.png, .jpeg, .bmp, .tiff).

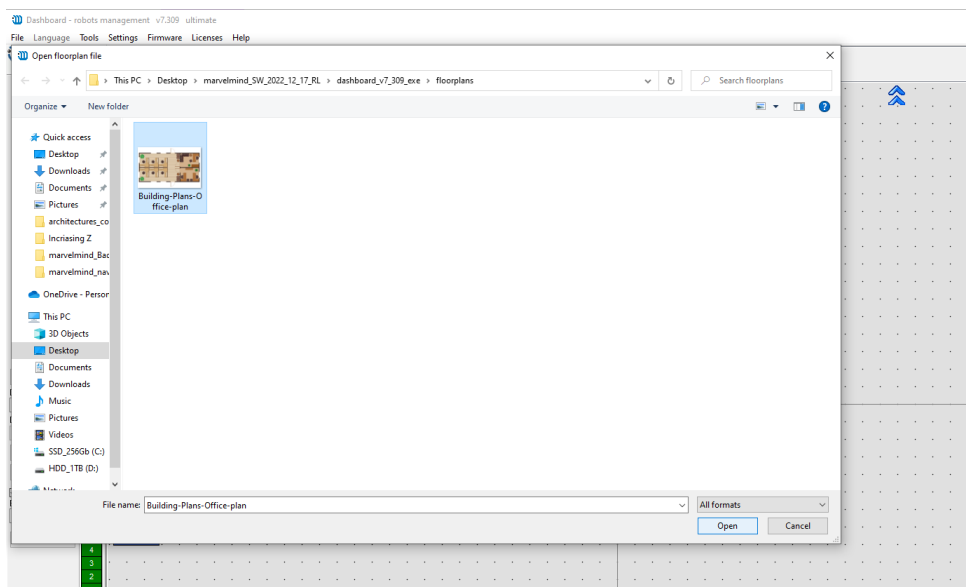

- Floorplan is loaded:

The screenshot displays the Marvelmind robots management software interface. The central area shows a detailed floorplan of a building with various rooms, corridors, and furniture. The floorplan is overlaid on a grid. On the left side, there is a sidebar with a 'Floors' list and a 'Clear map' button. Below the floorplan, there is a 'Submap 0' button and a 'Full' button. At the bottom, there is a 'Modem-d' section with a list of devices and their status, and an 'Indoor GPS' section. On the right side, there is a 'Settings' panel with a 'Read all' button and a 'Write all' button. Below the settings, there is a table of system parameters and their values.

Read all	Write all	Write changes	Cancel changes
CPU ID	Copy to clipboard	064A45	
Firmware version		v7.209 Modem HW v5.1.3	
Architecture		iA	
Location update rate		8 Hz	
Tracking quality threshold: % (0: 100)		0	
Track slow mode		Change dots for low quality	
Supply voltage: V (4.50, 5.50)		4.85	
Time from reset: h:m:s		00:09:12 / 13.12.13 / 0	
RSSI from 102: dBm		No data	
RSSI to 102: dBm		No data	
Profile		General	
Radio frequency band		"915 MHz"	
Center frequency: MHz		915.0	
Radio channel		0	
Device address (1..254)		1	
Long time sleep		disabled	
Window of averaging (0..16)		n/a	
Distance filter (0..16)		n/a	
Max. hedgehog resolut per cycle (1..255)		10	
High resolution mode (mm)		enabled	
Detect new beacons on frozen map		enabled	
Temperature of air: °C (20..60)		23	
Update location mode		Automatic	
Submap stands		n/a	
All hedgehogs update every cycle		n/a	
Advanced settings		<input checked="" type="checkbox"/> expand	
Spot filtering		<input type="checkbox"/> disabled	
Parameters of radio		<input checked="" type="checkbox"/> expand	
Interfaces		<input checked="" type="checkbox"/> expand	
Georeferencing		<input checked="" type="checkbox"/> expand	
Stationary beacons visible		enabled	
Service zones visible		enabled	
Service zones active		enabled	
Map grid visible		enabled	
Map area visible		enabled	
Fixed beacons angle visible		disabled	
Beacons view		normal	

2) Set floorplan scale by two points:

- Right Click on the floorplan => Set floorplan scale by two points:

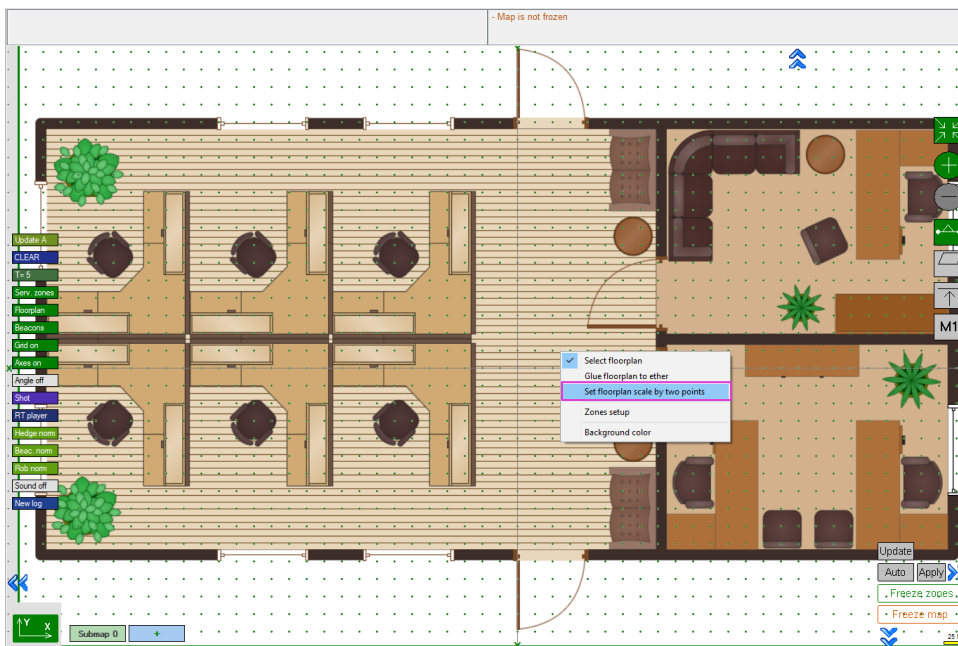

- Click first point on floorplan (press ESC to cancel):

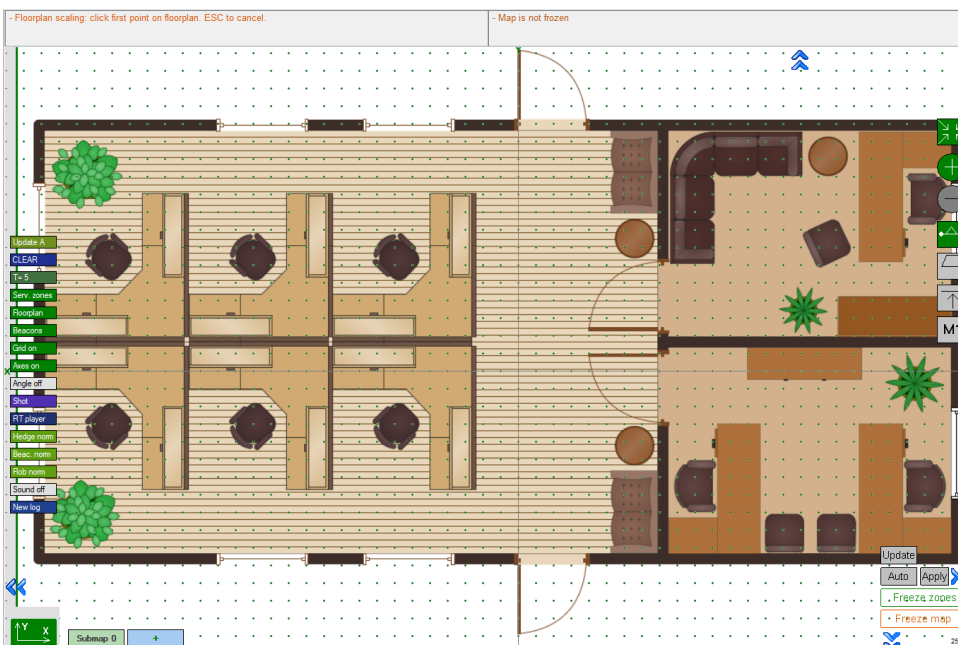

- Black cross will appear in a chosen point:

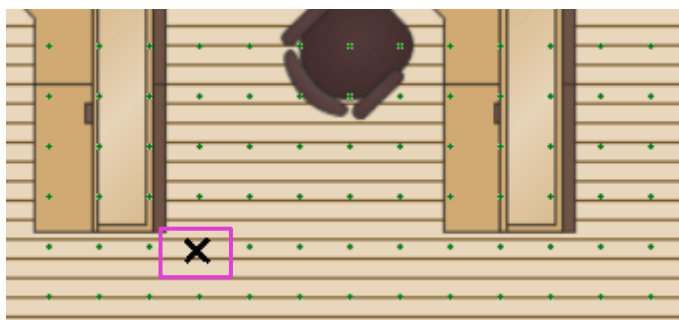

- Click second point on floorplan:

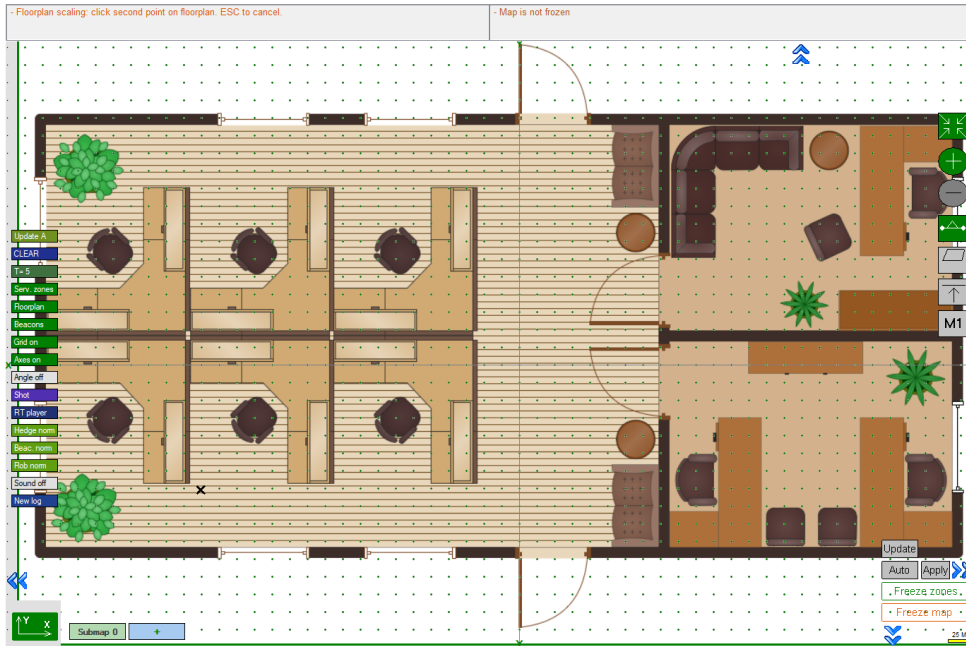

- Enter distance between points:

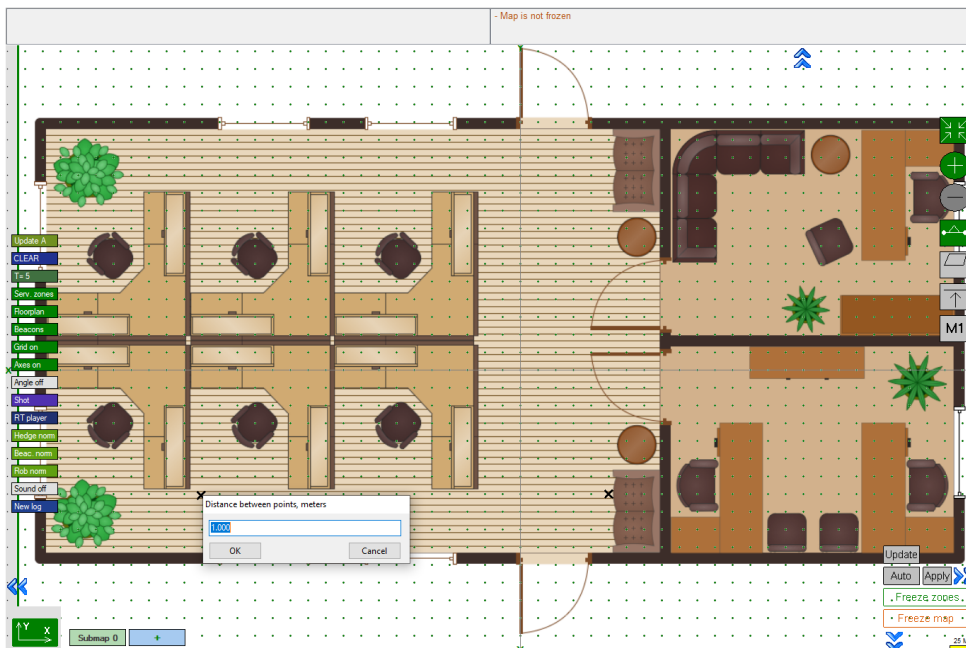

- The scale of the plan will adjust to the specified parameters:

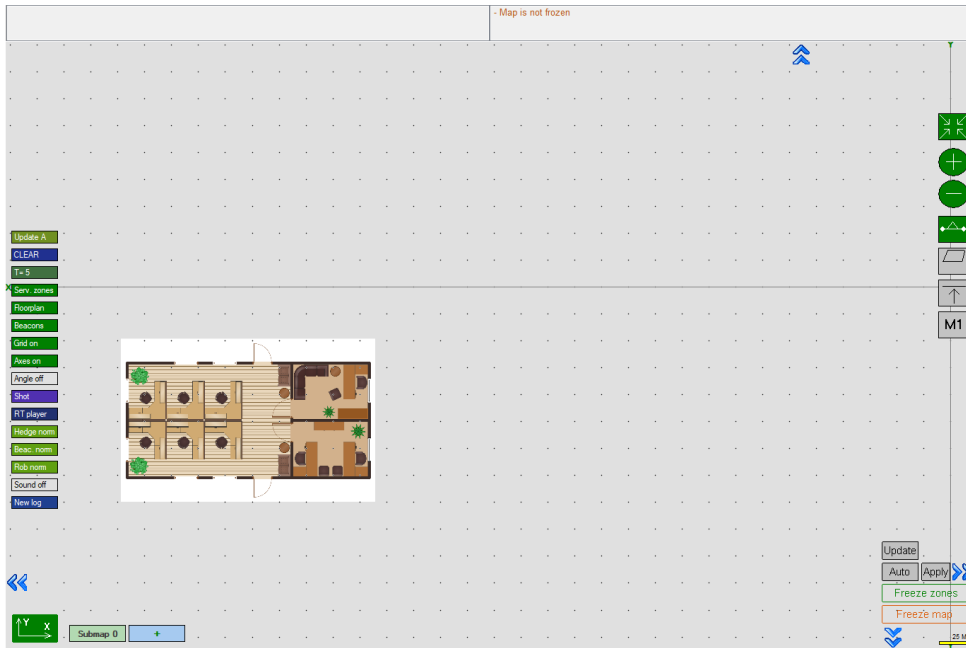

- Change a scale of the Map using mouse roll:

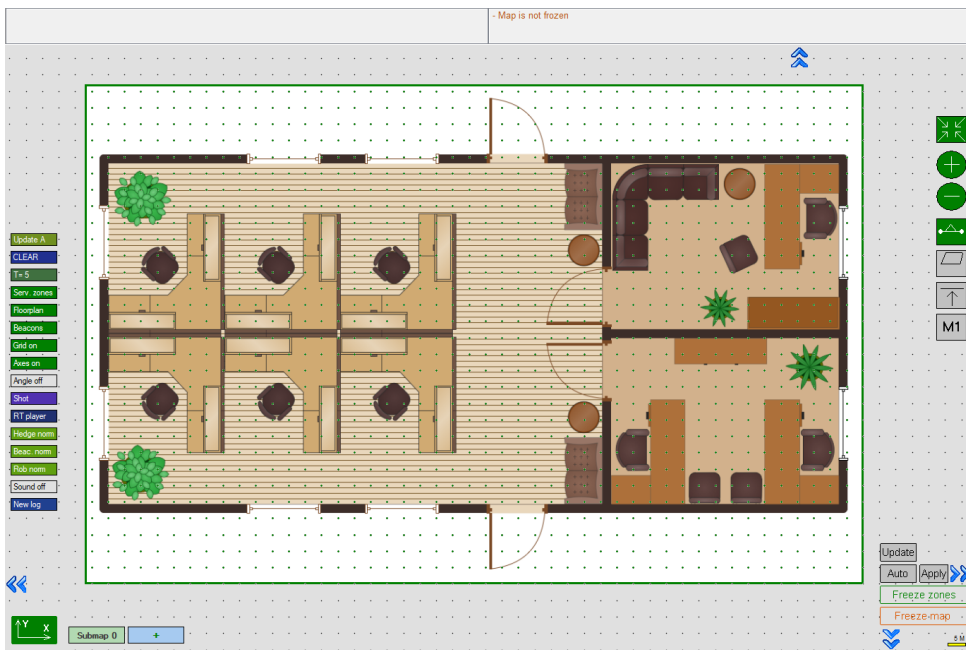

- Scale settings completed.

9.10.3. Move the floorplan on the Map

- To move the floorplan, click on it with the left mouse button and hold the button down:

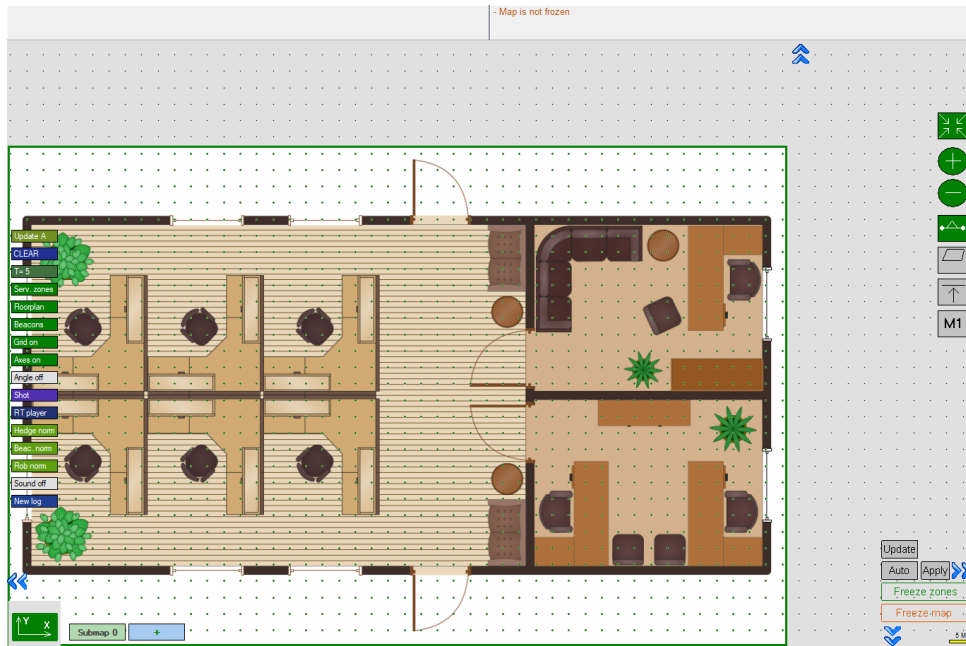

- Drag the plan to the desired location:

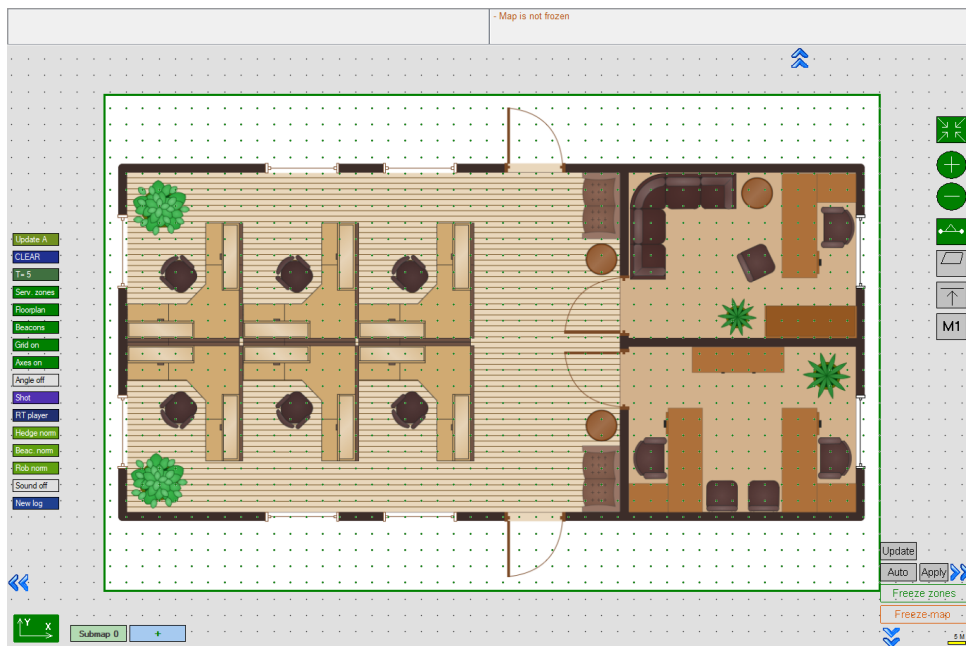

9.10.4. Other floorplan settings

- Right click to a floorplan area, to see an additional menu. Press “Glue floorplan to ether” to fix a position of floor plan according to map grid.

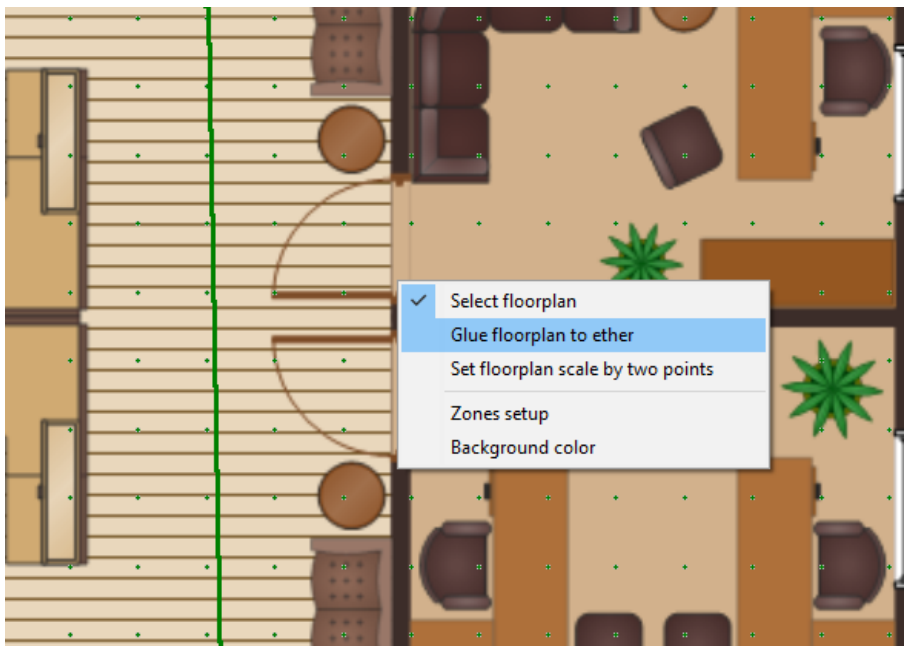

- Right click to a beacon, to see an additional menu. Here you can nail beacon to a floorplan or an ether.

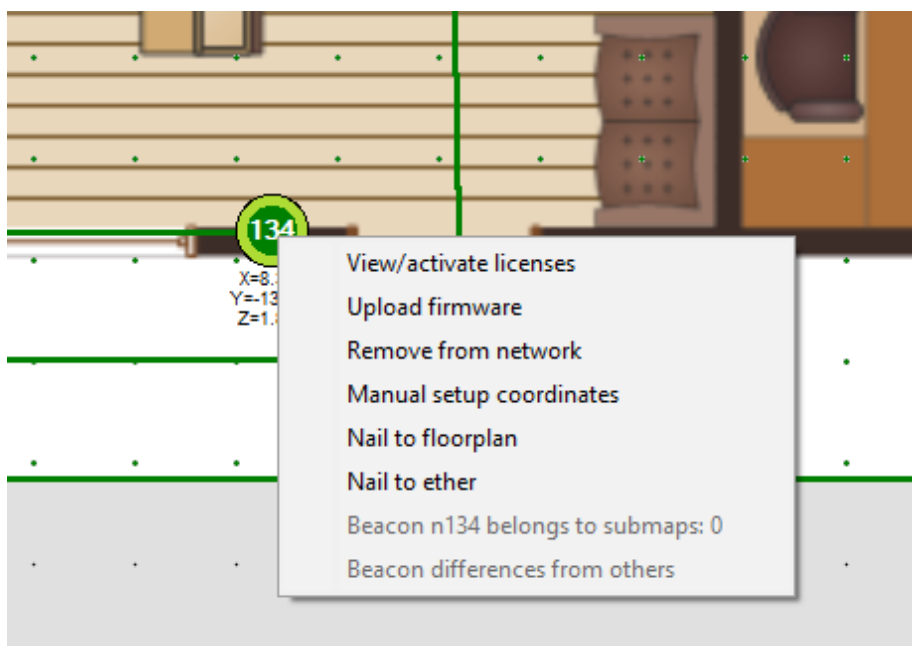

9.11. All hedgehogs update every cycle

To use All hedgehogs update every cycle feature license MMSW 0004 (MF NIA) and MMSW0008 needed and Marvelmind SW from version 7.200 and latest.

This feature gives simultaneous emission of all mobile beacons in **MF NIA** (to increase the update rate in cases where it is known that they won't interfere with each other).

How to use it:

- Make sure that licenses MMSW 0004 and MMSW 0008 activated for all beacons in the system:

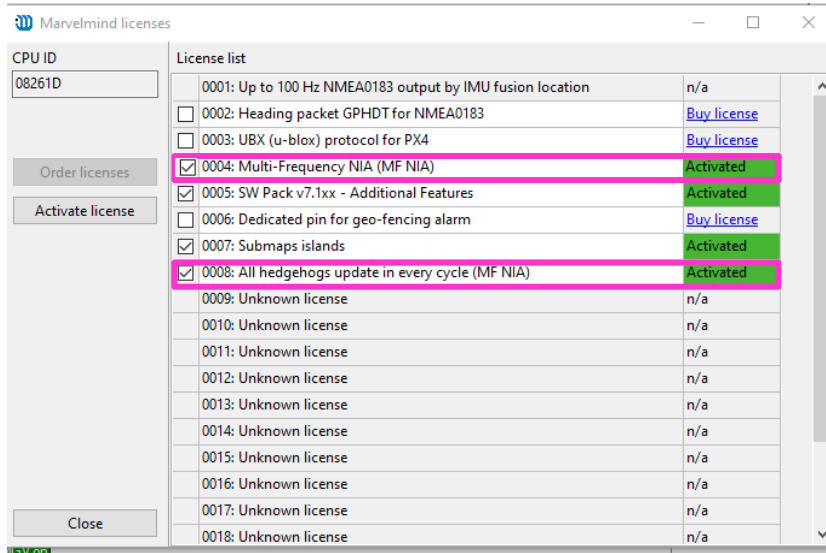

- Choose modem:

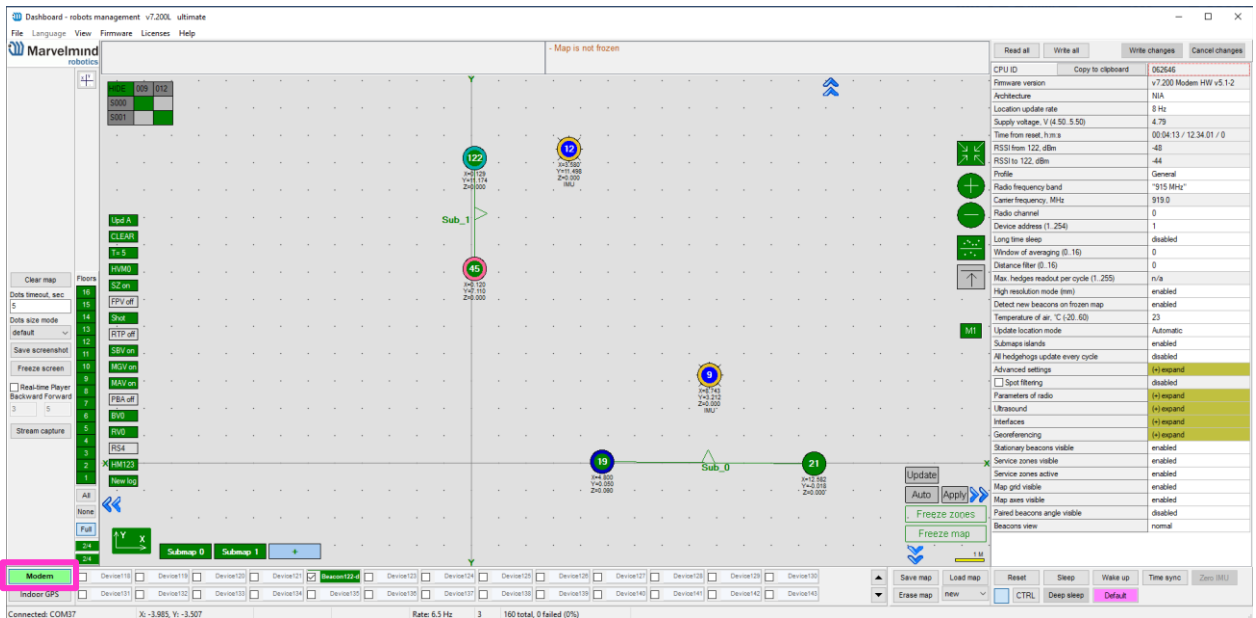

- Enable All hedgehogs update every cycle in the settings bar. Left mouse click on disabled (if feature switched off)

Device address (1..254)	1
Long time sleep	disabled
Window of averaging (0..16)	0
Distance filter (0..16)	0
Max. hedges readout per cycle (1..255)	n/a
High resolution mode (mm)	enabled
Detect new beacons on frozen map	enabled
Temperature of air, °C (-20..60)	23
Update location mode	Automatic
Submaps islands	enabled
All hedgehogs update every cycle	disabled
Advanced settings	(+) expand
<input type="checkbox"/> Spot filtering	disabled
Parameters of radio	(+) expand
Ultrasound	(+) expand
Interfaces	(+) expand
Georeferencing	(+) expand

- Now all mobile beacons update every cycle.

9.12. Filters

Those features help to get more stable tracking and avoid “jumps” of the mobile beacons.

9.12.1. Spot filtering (for IA only)

This feature using to filter mobile beacons “jumps” in Dashbord.

This feature works from the Modem.

How to use:

<input checked="" type="checkbox"/> Spot filtering	(-) collapse
Samples number (1..10)	3
Max. distance between updates, m (0.1..2.5)	1.0
Filtering during tracking	disabled

- When Modem connected to PC, choose it in Dashboard and put a tick next to

<input checked="" type="checkbox"/> Spot filtering	(-) collapse
Samples number (1..10)	3
Max. distance between updates, m (0.1..2.5)	1.0
Filtering during tracking	disabled

Spot filtering parameter. This is number of dots, when filter:

<input checked="" type="checkbox"/> Spot filtering	(-) collapse
Samples number (1..10)	3
Max. distance between updates, m (0.1..2.5)	1.0
Filtering during tracking	disabled

- Insert Samples number (minimum number of dots when filtering starts):

<input checked="" type="checkbox"/> Spot filtering	(-) collapse
Samples number (1..10)	3
Max. distance between updates, m (0.1..2.5)	1.0
Filtering during tracking	disabled

- Insert Max. distance between updates (maximum distance between points):
- Enable Filtering during tracking, for filtering when device moves.

9.12.2. Window of averaging (NIA only)

Sliding window size averaging the position of mobile beacons.

How to use:

- Choose Modem when it connected to PC and insert Sliding window size in Window of averaging bar:

Radio channel	0
Device address (1..254)	1
Long time sleep	disabled
Window of averaging (0..16)	0
Distance filter (0..16)	0



Notice, when this feature is on, latency increases.

9.13. Submap Settings

Every submap has its own settings.

Starting beacon trilateration (0..255)	0	Which beacon will have origin (0; 0; 0) coordinates
Starting set of beacons	60; 61;0;0	Addresses of beacons which are building this submap
3D navigation	enabled	3D (X; Y; Z) Tracking mode for this submap
Only for Z coordinate	disabled	To enable "Vertical submap for stable Z" configuration
Hedges height in 2D mode, m (-320.00..320.00)	0.00	Height of hedges for "Vertical submap for stable Z"
Limitation distances	service zone based	Maximum measuring distance limitation mode
Maximum distance, m (1..120)	30	Maximum measuring distance between stationary and mobile
Service zone thickness, m (-320.00..320.00)	10.00	Service zone thickness value in meters
Submap X shift, m (-320.00..320.00)	0.00	Submap X shift value in meters
Submap Y shift, m (-320.00..320.00)	0.00	Submap Y shift value in meters
Submap Z shift, m (-320.00..320.00)	0.00	Submap Z shift value in meters
Submap rotation, degrees (-360.00..360.00)	0.00	Submap rotation value in degrees
Plane rotation X, degrees (-360.00..360.00)	0.00	Plane rotation, X value ("Vertical submaps for stable Z")
Plane rotation Y, degrees (-360.00..360.00)	0.00	Plane rotation, Y value ("Vertical submaps for stable Z")
Plane rotation Z, degrees (-360.00..360.00)	0.00	Plane rotation, Z value ("Vertical submaps for stable Z")
Stationary beacons visible	enabled	Visibility of stationary beacons (Only displaying setting)
Service zone visible	enabled	Visibility of service zones (Only displaying setting)

For example, to correspond your submap to a certain floor you need to adjust the height:

- Left click on the submap icon to open the settings-
- Change Submap Z shift value

Submap 0

<input type="button" value="Read all"/> <input type="button" value="Write all"/>	
Starting beacon trilateration (0..255)	0
Starting set of beacons	0; 0;0;0
3D navigation	enabled
Only for Z coordinate	disabled
Limitation distances	manual
Maximum distance, m (1..100)	30
Submap X shift, m (-320.00..320.00)	0.00
Submap Y shift, m (-320.00..320.00)	0.00
Submap Z shift, m (-320.00..320.00)	16.00
Submap rotation, degrees (-360.00..360.00)	0.00
Plane rotation X, degrees (-360.00..360.00)	0.00
Plane rotation Y, degrees (-360.00..360.00)	0.00
Plane rotation Z, degrees (-360.00..360.00)	0.00
Service zone thickness, m (-320.00..320.00)	0.00
Hedges height in 2D mode, m (-320.00..320.00)	1.85

9.14. Axis rotation feature (FN0002)

9.14.1. General view

Axis extension enables rotation of the map. There are 90° gaps between views. It helps in case of multifloor tracking when it is important to have a side view.

There are 3 directions of view:

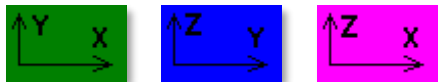

- To change view, click on the icon

9.14.2. Examples of view:

Y, X



X, Y

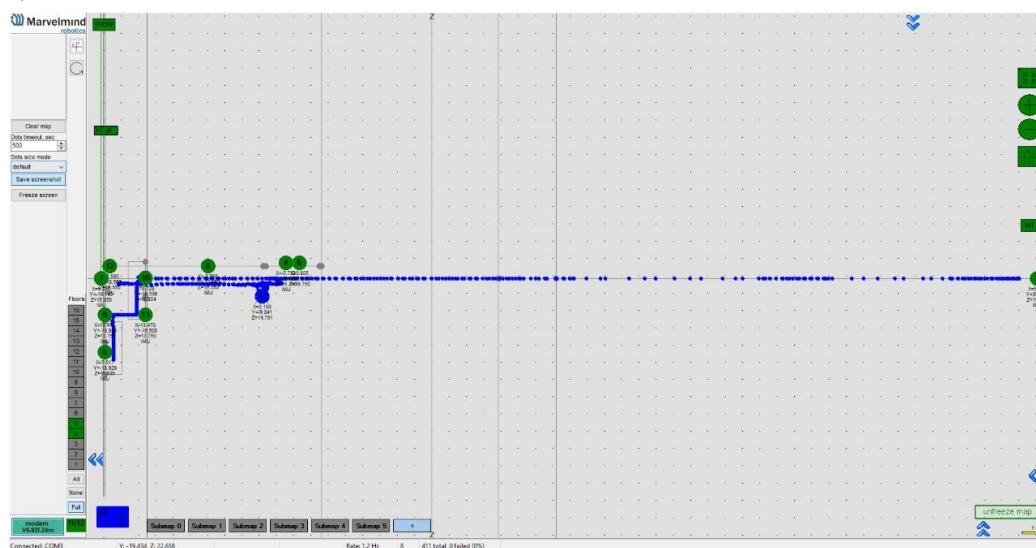

Z, X

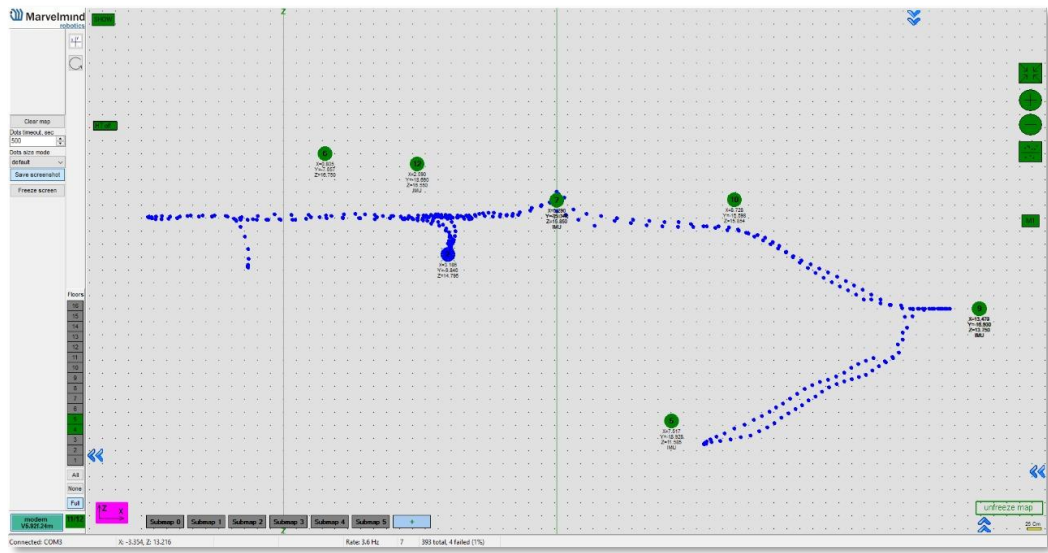

9.15. Vertical submaps feature (FN0003)

Vertical submap is a new feature for drone flights or some other specific cases. It gives the user an opportunity to get solid Z data for vertical movement

- Example: The drone flight

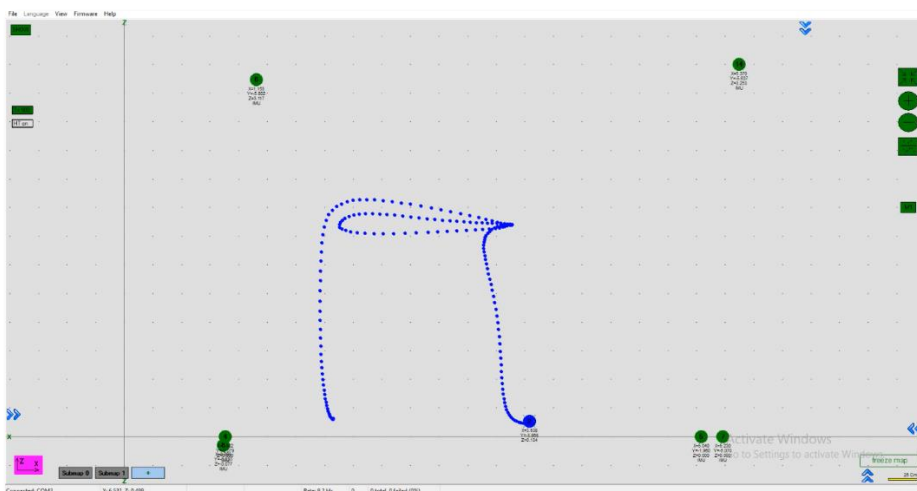
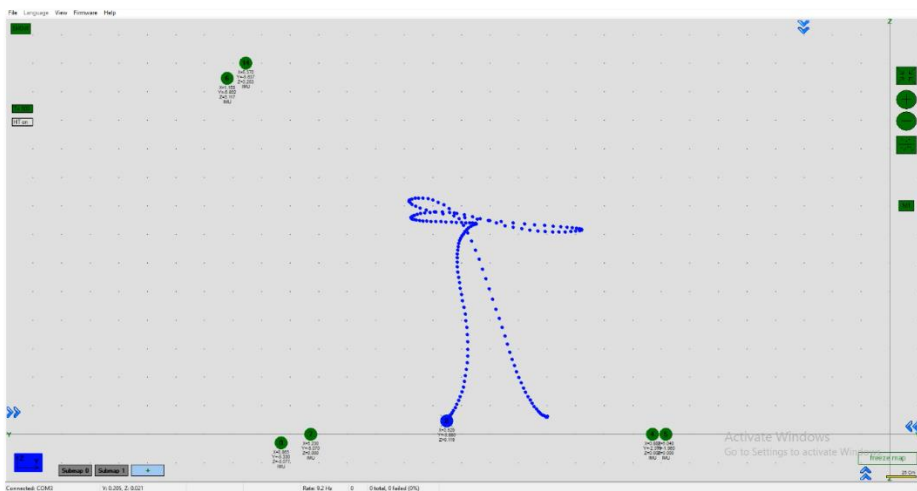
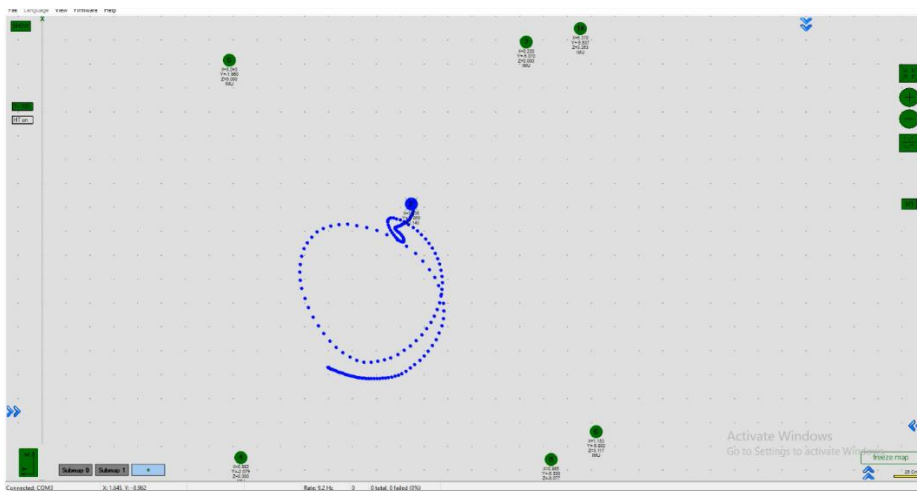

9.15.1. How to build vertical submap for stable Z:

- 9.15.1.1. For this configuration you need 6 stationary beacons
- 9.15.1.2. Place 4 beacons on the ground, facing each other. (make a square, where the edge points are beacons, looking in the center)
- 9.15.1.3. Place two beacons high on a wall
- 9.15.1.4. Turn on RX4 only for beacons on the ground and RX4 and RX2 for beacons on the wall
- 9.15.1.5. Build the first submap (horizontal) consisting of all ground beacons
- 9.15.1.6. Change **Limitation distance** to **manual** and input the value in the submap's settings

Read all		Write all	
Starting beacon trilateration (0..255)	0		
Starting set of beacons	6; 7;0;0		
3D navigation	enabled		
Only for Z coordinate	disabled		
Limitation distances	manual		
Maximum distance, m (1..100)	12		
Submap X shift, m (-320.00..320.00)	0.00		
Submap Y shift, m (-320.00..320.00)	0.00		
Submap Z shift, m (-320.00..320.00)	0.00		
Submap rotation, degrees (-360.00..360.00)	0.00		
Plane rotation X, degrees (-360.00..360.00)	0.00		
Plane rotation Y, degrees (-360.00..360.00)	0.00		
Plane rotation Z, degrees (-360.00..360.00)	0.00		
Service zone thickness, m (-320.00..320.00)	0.00		
Hedges height in 2D mode, m (-320.00..320.00)	0.00		

- 9.15.1.7. Freeze and lock it



- 9.15.1.8. Build the second submap (vertical) horizontally consisting of two wall beacons and two ground beacons (neighboring with wall beacons)

- 9.15.1.9. Now, freeze it



- 9.15.1.10. Press axis rotation button

- 9.15.1.11. Click on the axis you want to rotate your submap along (when you point the cursor on the axis, it became visible and pink-colored)

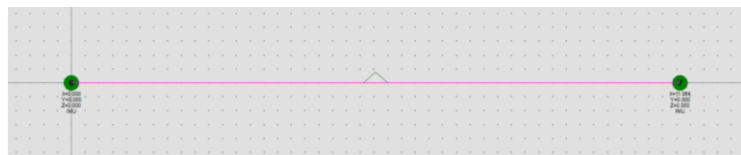

- 9.15.1.12. Enter the corner value (90° usually)

Enter rotation angle

OK Cancel

9.15.1.13. Choose submap 2 and enable “Only for Z coordinates” mode

Read all		Write all	
Starting beacon trilateration (0..255)		0	
Starting set of beacons		0; 0;0;0	
3D navigation		enabled	
Only for Z coordinate		enabled	
Limitation distances		manual	
Maximum distance, m (1..100)		25	
Submap X shift, m (-320.00..320.00)		0.00	
Submap Y shift, m (-320.00..320.00)		0.00	
Submap Z shift, m (-320.00..320.00)		0.00	
Submap rotation, degrees (-360.00..360.00)		0.00	
Plane rotation X, degrees (-360.00..360.00)		-88.24	
Plane rotation Y, degrees (-360.00..360.00)		1.15	
Plane rotation Z, degrees (-360.00..360.00)		-0.57	
Service zone thickness, m (-320.00..320.00)		0.00	
Hedges height in 2D mode, m (-320.00..320.00)		0.00	

9.15.1.14. Change Limitation distance value

Read all		Write all	
Starting beacon trilateration (0..255)		0	
Starting set of beacons		6; 7;0;0	
3D navigation		enabled	
Only for Z coordinate		enabled	
Limitation distances		manual	
Maximum distance, m (1..100)		12	
Submap X shift, m (-320.00..320.00)		0.00	
Submap Y shift, m (-320.00..320.00)		0.00	
Submap Z shift, m (-320.00..320.00)		0.00	
Submap rotation, degrees (-360.00..360.00)		0.00	
Plane rotation X, degrees (-360.00..360.00)		0.00	
Plane rotation Y, degrees (-360.00..360.00)		0.00	
Plane rotation Z, degrees (-360.00..360.00)		0.00	
Service zone thickness, m (-320.00..320.00)		0.00	
Hedges height in 2D mode, m (-320.00..320.00)		0.00	

9.15.1.15. Change views and check the map

9.15.1.16. Wake up mobile beacon

9.15.1.17. Track

9.16. Submaps feature (FN0004)

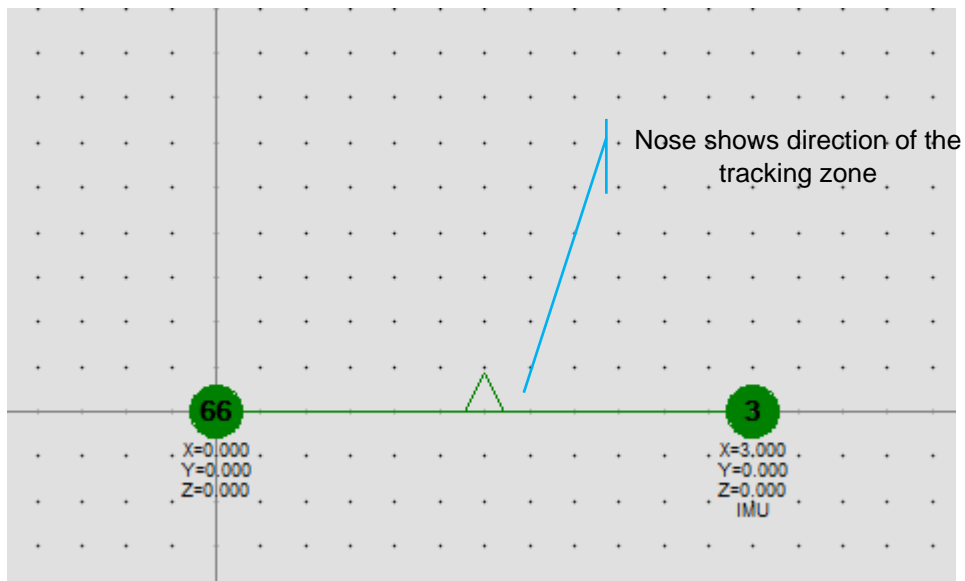

2D submap example

Submaps is a very powerful feature that allows building large maps (full business center, factory, warehouse with total area of 10,000..300,000 or more) based on smaller submaps (30..1000m2).

A submap is a part of the map. It includes a subset of used beacons covering part of the navigation area. Current version of Marvelmind system can include up to 10 submaps. Please also check our [help video](#).



9.16.1. Starting submaps

Hedgehogs do not belong to any submap and can move between sub-map areas. Hedgehogs can be served by multiple submaps at the same time. By default, the map consists of a single submap (Submap0)

- 9.16.1.1. After adding new beacons to the system (waking them up), they appear in the first not frozen submap or in Submap0 if all beacons are frozen

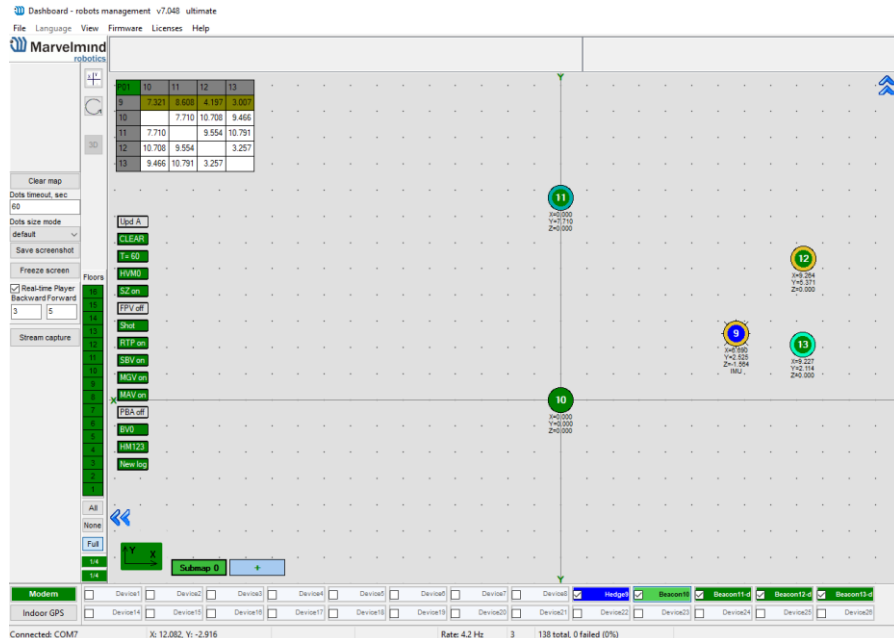

- 9.16.1.2. Pressing the “+” button will add a new empty submap to the system

- 9.16.1.3. Press the button with the submap number (Submap0, Submap1 etc.) - select the corresponding submap

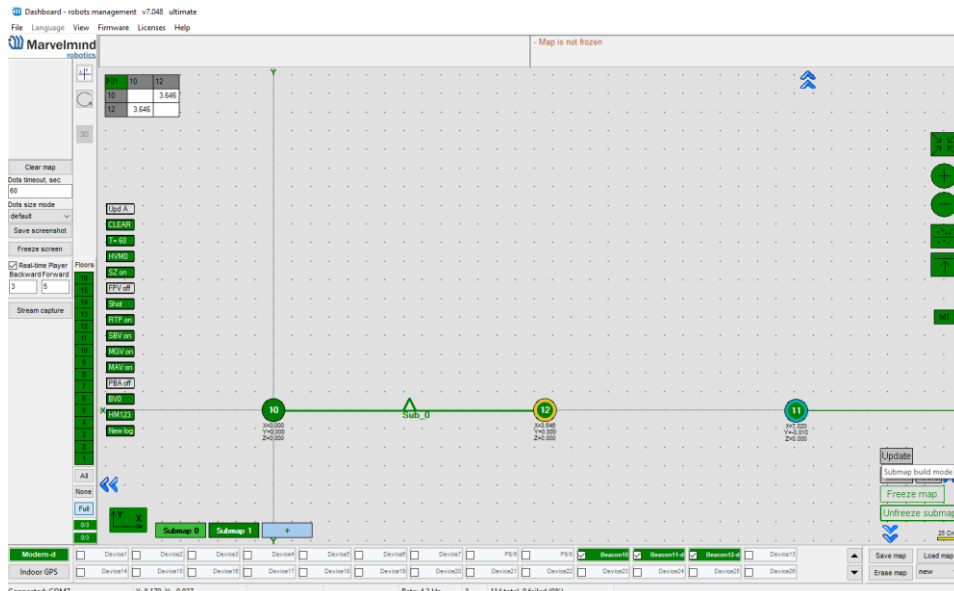

- 9.16.1.4. In this state, if the modem button is pushed, the list of parameters on the right side represents some of the parameters of the selected submap, for example, “Starting beacon trilateration,” “Starting set of beacons,” etc.

- 9.16.1.5. The system after adding beacons to the Submap0, adding new submap and the selection of Submap0

- 9.16.1.6. Now we have 4 beacons, all in Submap0 (it can be seen near the table of distances)
- 9.16.1.7. With the submap selected, the context menu of beacons buttons (available by right clicking) have the functions of adding and removing

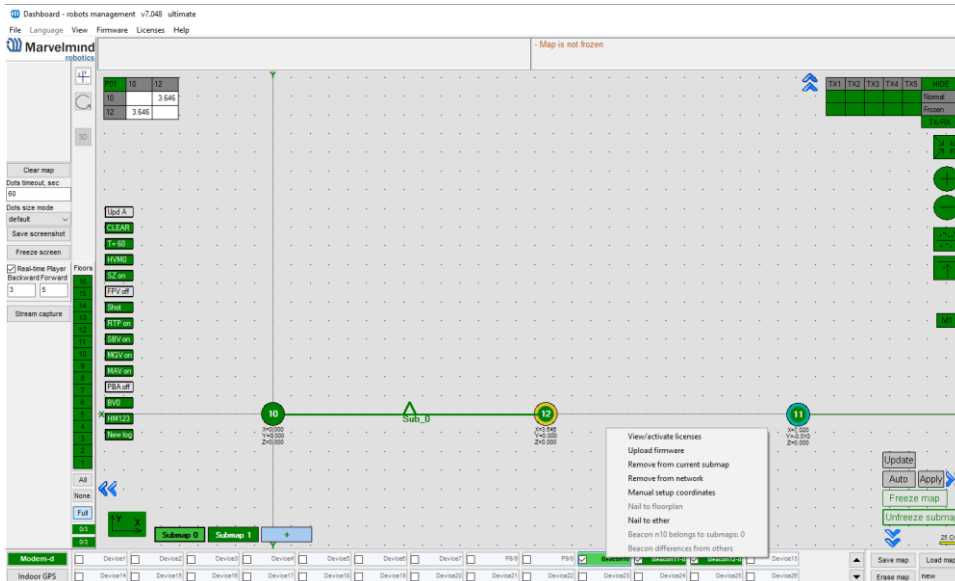

the beacons from the submap. In the picture above, we are removing beacon 3 from Submap0.” Then we switch to Submap1 and add this beacon to the submap

- 9.16.1.8. When the submap is selected, the beacons that do not belong to the submap are colored **gray**. In the same way, continue with removing beacon 10 from Submap0 and adding it to Submap1
- 9.16.1.9. Now there are two beacons in Submap1, so this submap is built. “Submap 0” is built as well. Now we can freeze both submaps
- 9.16.1.10. Pressing the “freeze map” button when the submap is selected will only freeze the selected submap. Pressing the “freeze map” button when the modem button is selected will freeze all submaps.
- 9.16.1.11. Now we have two good submaps, but they are not correctly located relative to each other. On the right side exist the parameters of shift and rotation for the selected submap; they can be filled in by hands. But a more user friendly way is to drag and drop the selected submap using the mouse and holding down the CTRL button.

9.16.1.12. Rotation of submap can be executed by using the mouse wheel. The mirroring button can also be used; it affects only submaps that are selected

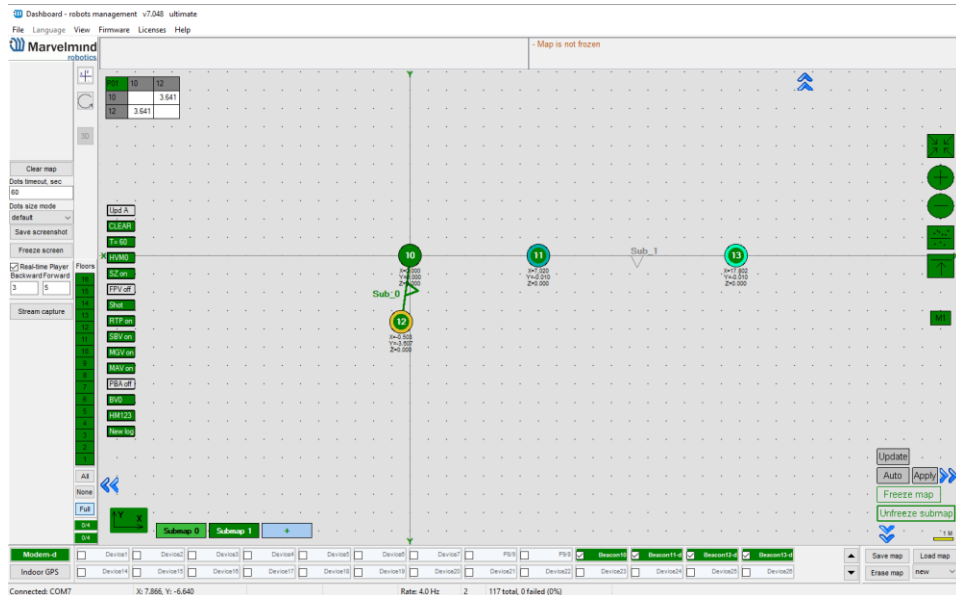

9.16.1.13. After some movement, rotation, and mirroring of submaps, we can locate the submaps close to their real relative location

9.16.1.14. Now the system is ready to use; we can wake up and track the mobile hedgehog

9.16.1.15. In some cases, the hedgehog can be lost between the submaps if this area is not covered by any of the submaps.

9.16.1.16. Submaps can be removed from the system by using the context menu of the submap selection button (available with a right click)

9.16.1.17. M1/M2 parameter used for precise superposing submaps which do not have common beacons. This means that submaps cannot be aligned automatically

To align submaps:

- Build the system like in previous instruction

- Put M2 in mode on by clicking the icon. Place the hedgehog near the boundary between two submaps. You will see 2 red hedgehogs blinking, this is how the hedge is seen in two submaps

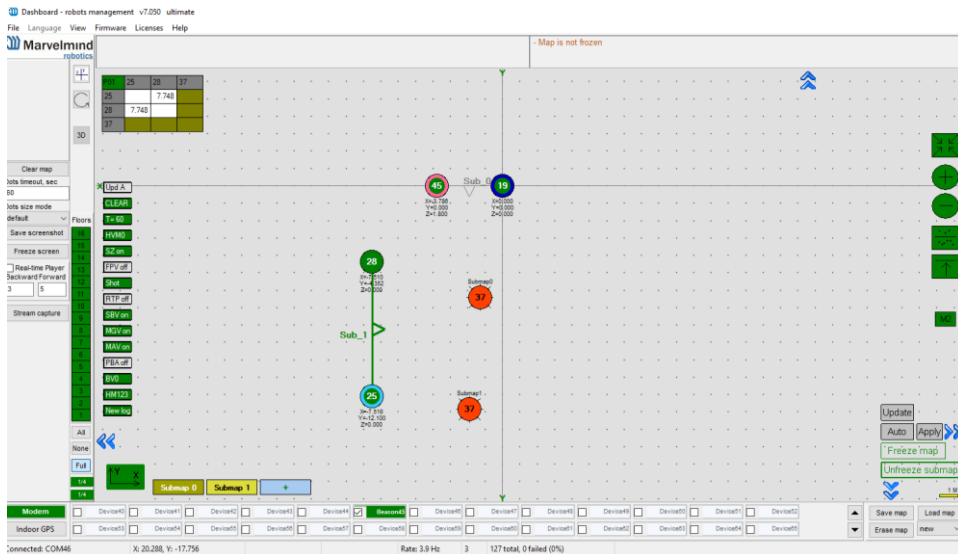

- To align submaps correctly (CTRL + scroll/drag) against each other, until the red mobile beacons are fully overlapped
- Replace hedgehog to 1 or 2 points and repeat replacing submap for better superposing

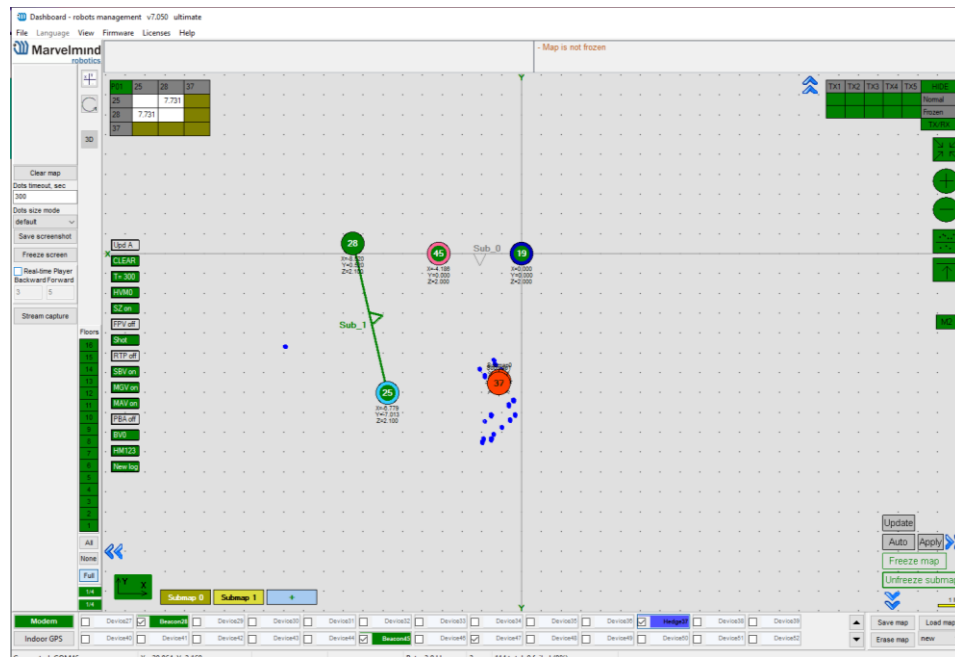

- The next step is to set Service zones, which are zones where tracking is possible. If a mobile beacon is out of a service zone it cannot be tracked. If you built a complicated map, you have to make service zones correctly. Service zones must be crossing in order to provide correct and glide tracking.

9.16.2. How to create a service zone:

9.16.2.1. Choose submap (click on the submap icon).



9.16.2.2. Use SHIFT + Left click on the map to create point.

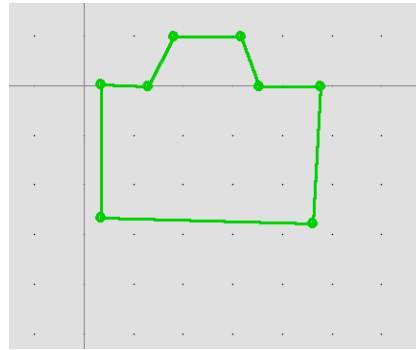

9.16.2.3. Use SHIFT + Left click on the point to delete it.

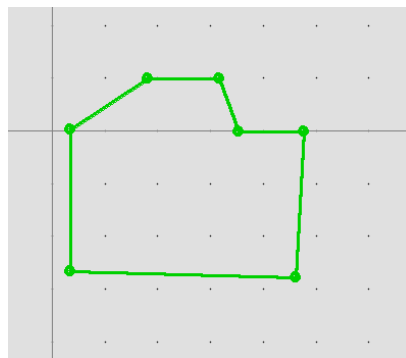

9.16.2.4. Use Right click on the point and choose "Clear all points" to delete service zone

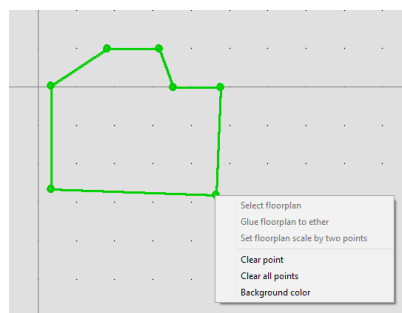

- 9.16.2.5. Put points around submap, move them to provide service area for current submap. Service areas will cross each other. If hedgehogs get lost between two submaps expand the service area.

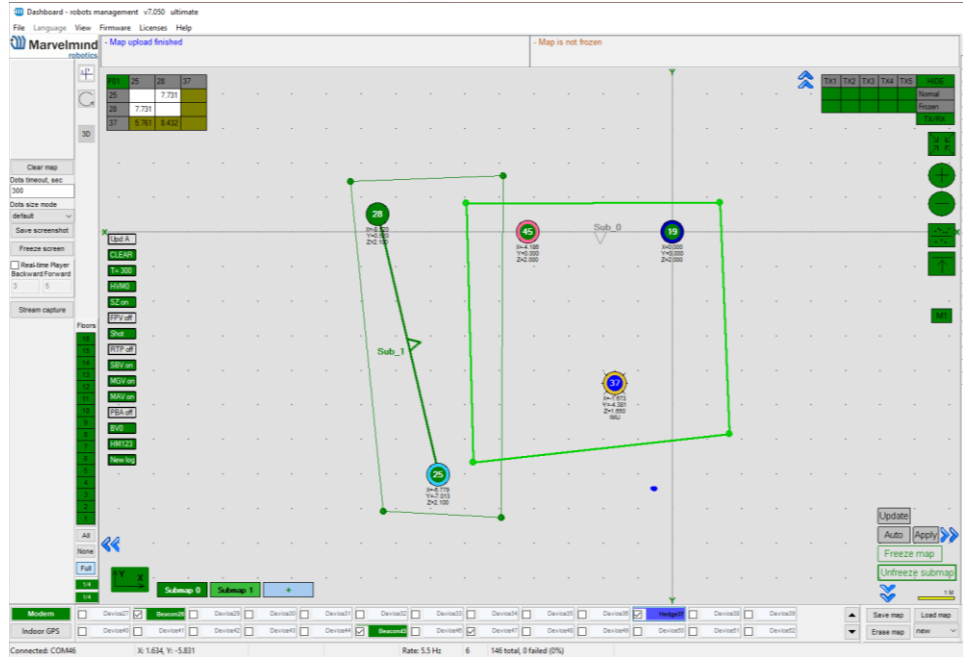

Learn more:

- [How to define and edit service zones](#) - How to define and edit service zones, full instruction
- [Help: submaps, service zones, handover zones](#) - This is a long and detailed video giving explanations on:
 - What is a submap
 - What is a service zone
 - What is a handover zone
 - How to build larger maps easily and successfully – many practical advises

9.17. Handover Zones Setting

User must setup handover zones between submaps to guarantee handover quality for complex maps with multi-floor and similar.

How to setup handover zones:

- Choose any submap

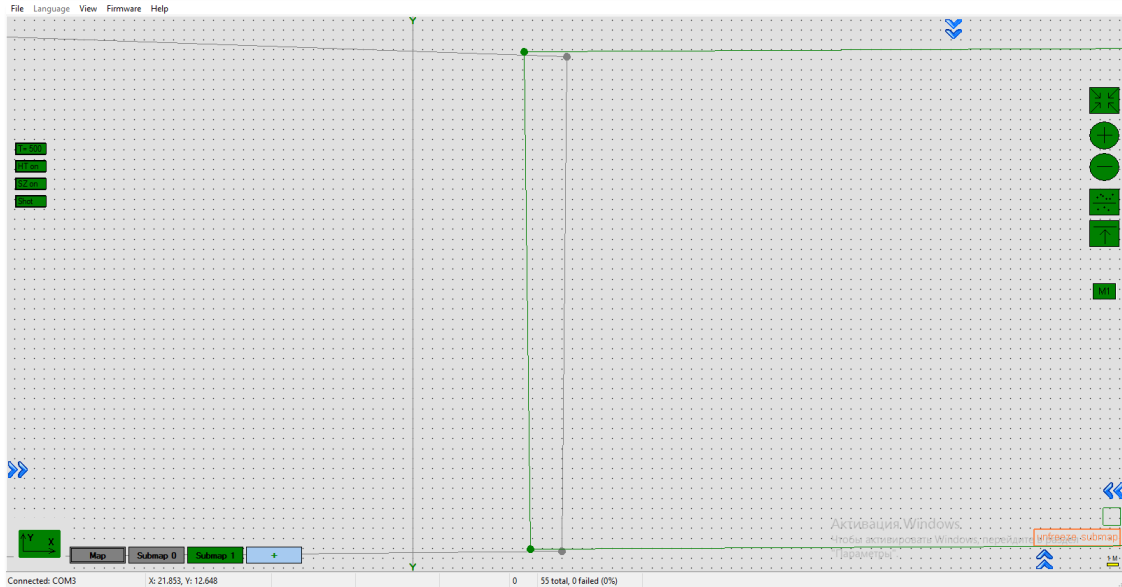

- Use **Alt + Left Click** on the other submap's service zone border (neighboring)
- Now, neighboring service zones are colored with green (dark green for chosen submap and light green for neighboring submaps)

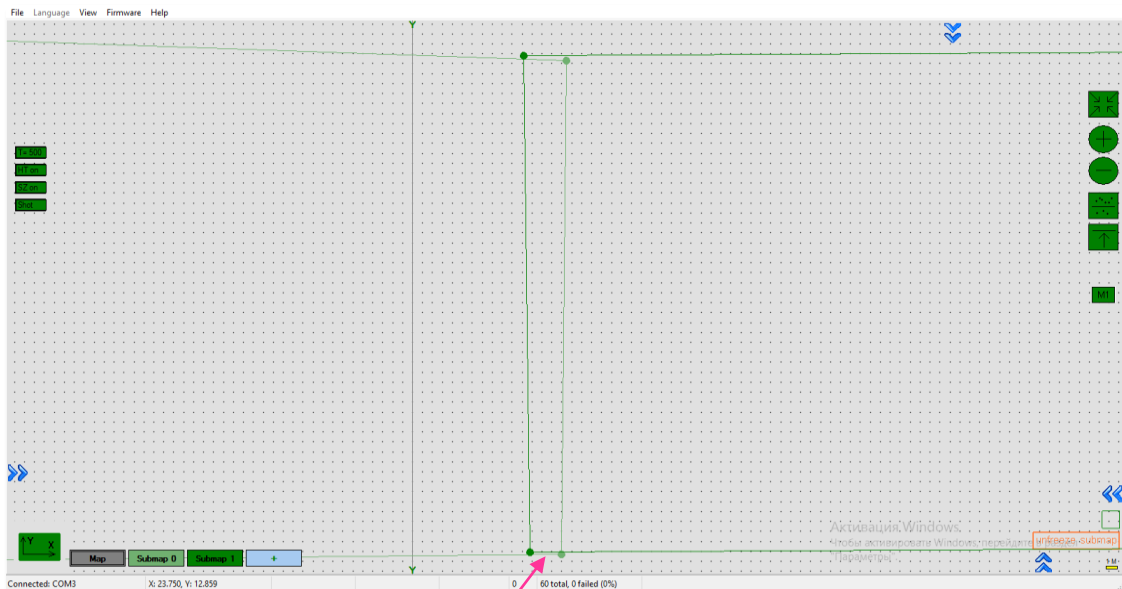

Alt + Left click

9.18. Paired beacons (FN0005)

Two hedgehogs can be paired and work together as a single beacon without update rate reduction. In this case you get not only location, but direction too.

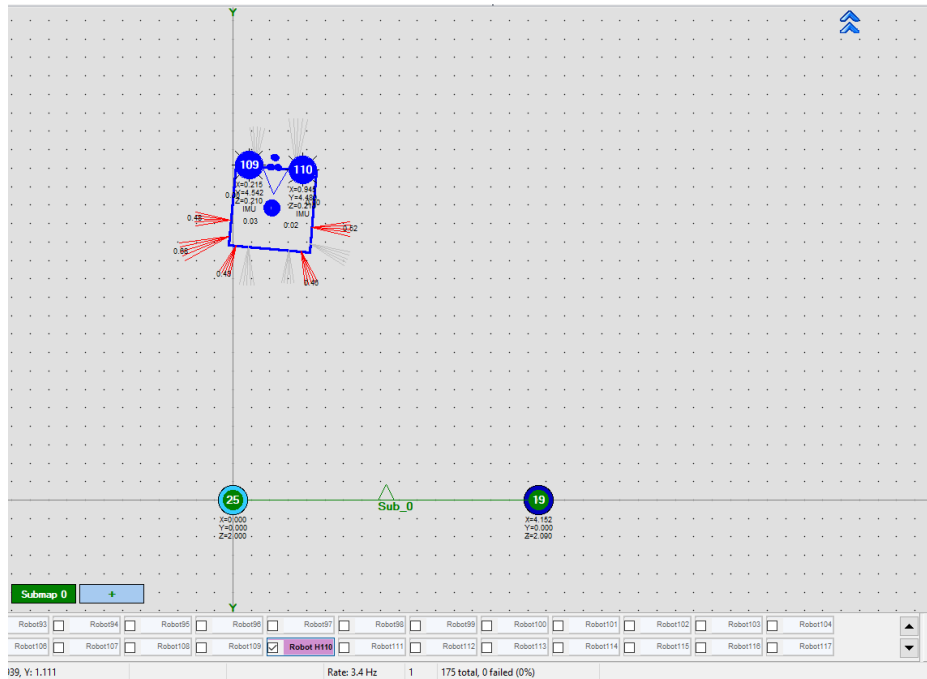

Moreover, each beacon streams out in this mode not only its own location, but direction where the pair is facing. This feature hugely simplifies autonomous driving and flight. Here is an updated [protocol](#) with the changes.



Please, also check our [help video](#).

How to pair beacons:

9.18.1. If you want to pair beacons via UART then connect Super Beacons with cable from USART_TX of the Following beacon by address to USART_RX of the Leading beacon by address and from GND to GND of each beacon (Note: Look at the pictures below and chapter 8). Only applicable to NIA

Leading Beacon (by address):

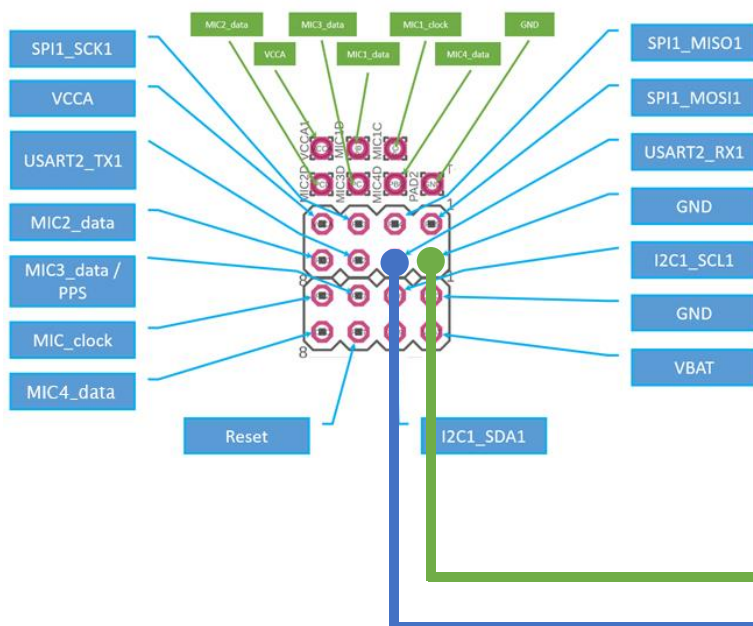

Following Beacon (by address):

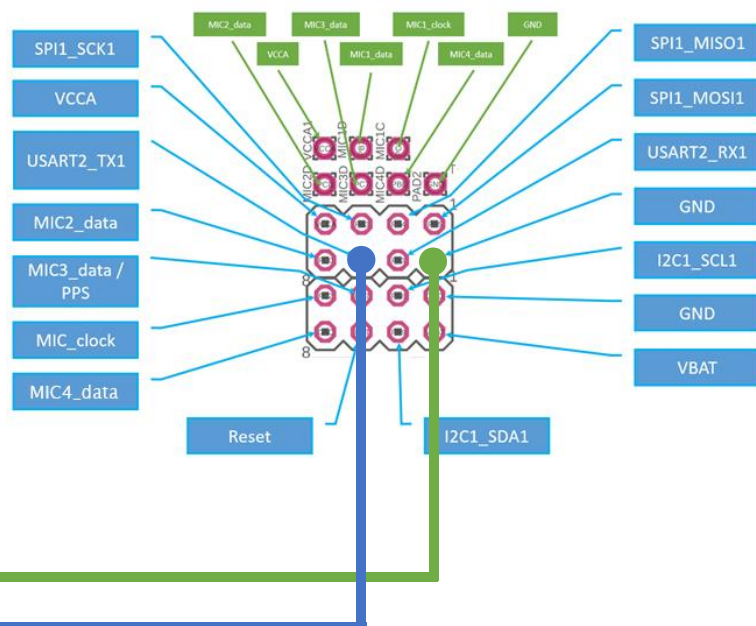

9.18.2. If you want to pair beacons via Radio do not connect beacons via anything and change “Communication in pair” on “via radio” later after point 9.17.1

Switch OFF Real Time player before setting up of the beacons pair. Real time player smooths a tracking what can strongly affect tracking of paired beacons.

9.18.3. Wake up one of the beacons from the pair and achieve a perfect tracking for a path (do not forget to freeze submap before tracking). If tracking is perfect, put this beacon to the sleeping mode and move to another beacon from the pair.

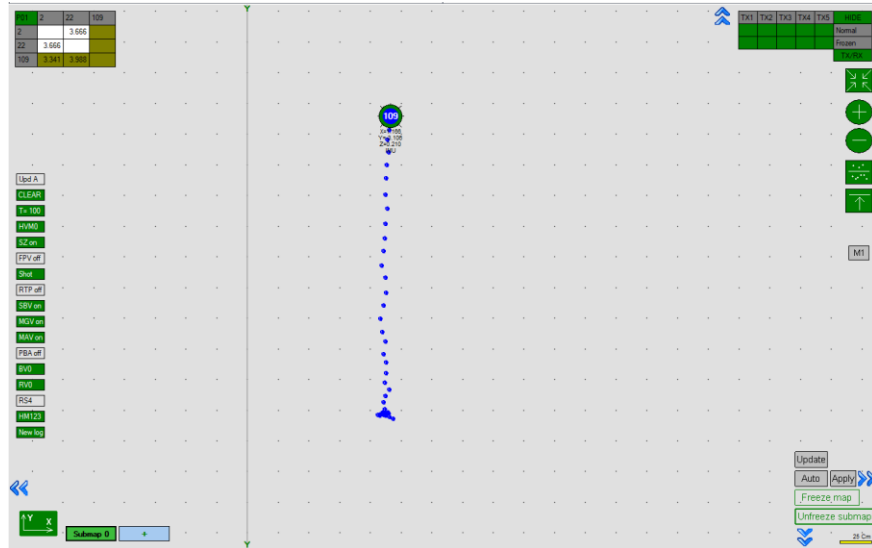

9.18.4. Wake up a beacon and repeat the same path, that been pass with the first beacon. If everything is good, move to the next step.

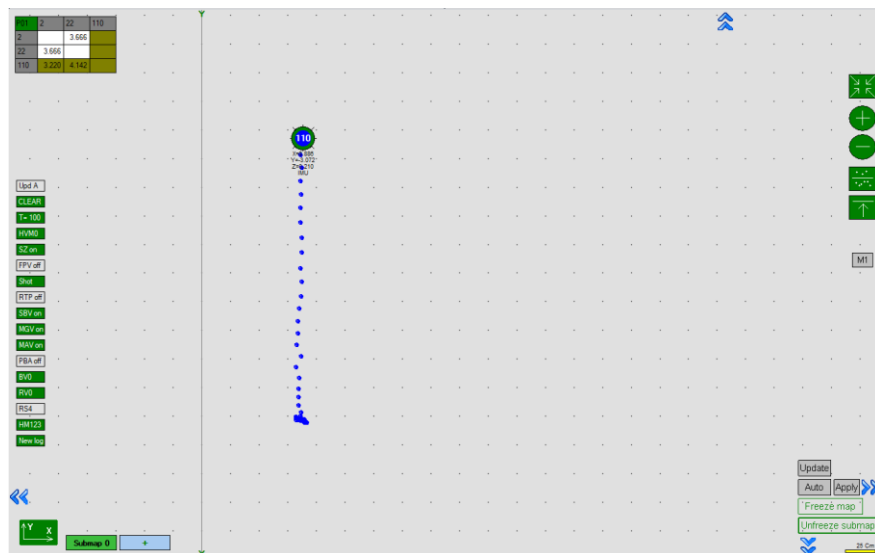

- 9.18.5. Wake up both beacons, do not pair them yet. Repeat the same path for both beacons. If tracking is good, pair the beacons.

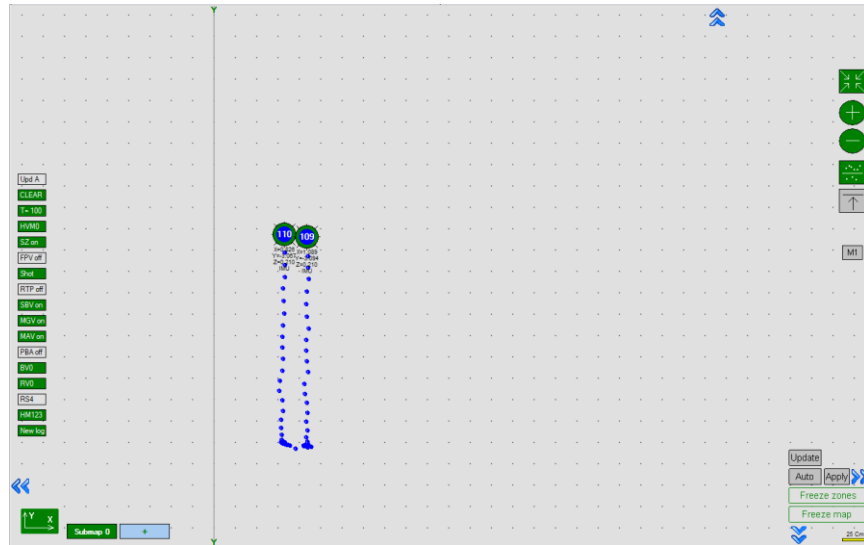

Beacons must be at least 20 cm apart. The farther the beacons are from each other, the more accurate the angle. Also if beacons are so close to each other it's better to connect it via UART, to avoid issues with tracking.

- 9.18.6. Choose one beacon and go to "Pairing mode" parameter and activate Pairing mode:

Hedgehogs pairing	(-) collapse
Pairing mode	no pairing

- 9.18.7. Choose "via radio" in Communication in pair.

Hedgehogs pairing	(-) collapse
Pairing mode	pair
Address of paired hedge (1..255)	1
Location against center	left
Base of the pair, cm (1..255)	10
IMU fusion for angle	enabled
Send location of center	enabled
Communication in pair	via radio

9.18.8. Write the “Address of paired beacon” , means number of the beacon, current selected hedgehog is paired with:

Hedgehogs pairing	(-) collapse
Pairing mode	pair
Address of paired hedge (1..255)	109
Location against center	left
Base of the pair, cm (1..255)	10
IMU fusion for angle	enabled
Send location of center	enabled
Communication in pair	via radio

9.18.9. Now choose location against center in parameters relatively the second

Hedgehogs pairing	(-) collapse
Pairing mode	pair
Address of paired hedge (1..255)	109
Location against center	left
Base of the pair, cm (1..255)	10
IMU fusion for angle	enabled
Send location of center	enabled
Communication in pair	via radio

beacon:

9.18.10. Go to “Base of the pair” parameter and write actual distance between paired hedgehogs:

9.18.11. Check that all settings are the same for paired beacon (except Location against center):

Hedgehogs pairing	(-) collapse
Hedgehogs pairing	(-) collapse
Pairing mode	pair
Address of paired hedge (1..255)	110
Location against center	right
Base of the pair, cm (1..255)	30
IMU fusion for angle	enabled
Send location of center	enabled
Communication in pair	via radio

9.18.12. Freeze a Map:

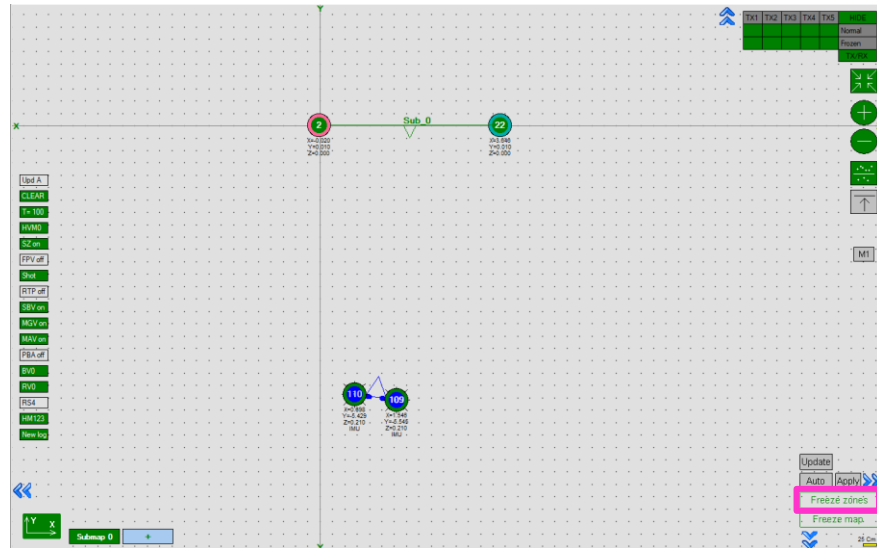

9.18.13. Pairing completed successfully:

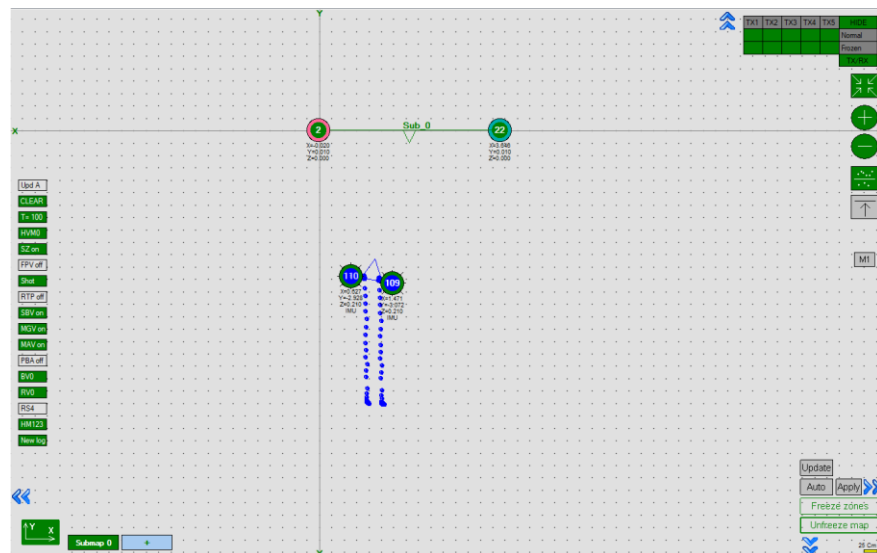

9.19. Paired microphones

You can also connect additional microphone and turn on “Paired microphones” mode to get the direction without taking a second beacon (Only for IA).

How to pair microphones:

- 9.19.1. Choose beacon in the beacon panel
- 9.19.2. Turn on the microphone which you connected additionally
- 9.19.3. Open “Hedgehogs pairing”
- 9.19.4. Enter to “Address of paired hedge” address of the beacon which you are setting up

Hedgehogs pairing	(-) collapse
Pairing mode	pair
Address of paired hedge (1..255)	200
Location against center	left
Base of the pair, cm (1..255)	10
IMU fusion for angle	enabled
Send location of center	enabled
Communication in pair	n/a

9.20. Map settings

Map Settings offer some helpful tools:

- Save map – saves map as *.ini* file into **Dashboard folder/maps**
- Load map – loads map from *.ini* format file
- Erase map – erases map and clears it

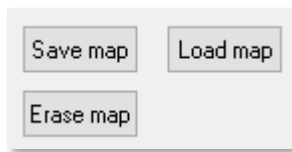

9.21. Background color

Starting from v6.200 Dashboard supports background color change.

This is a small feature that helps make tracking look better. If you uploaded a floorplan and it is white, you can tune Dashboard's background color to make it suit.

How to choose background color:

- Load floorplan

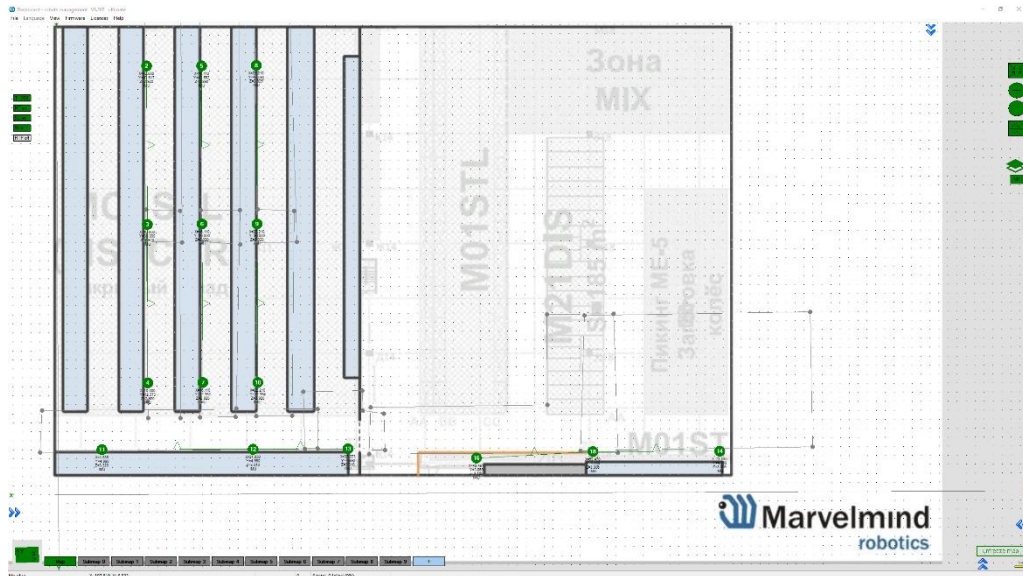

- Right click on the background

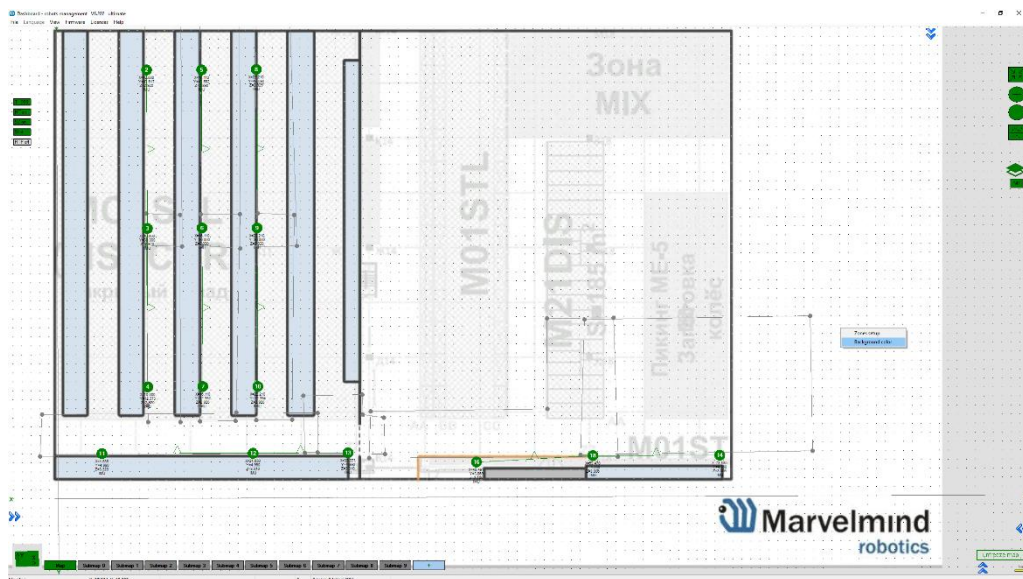

- Choose color and press "OK"

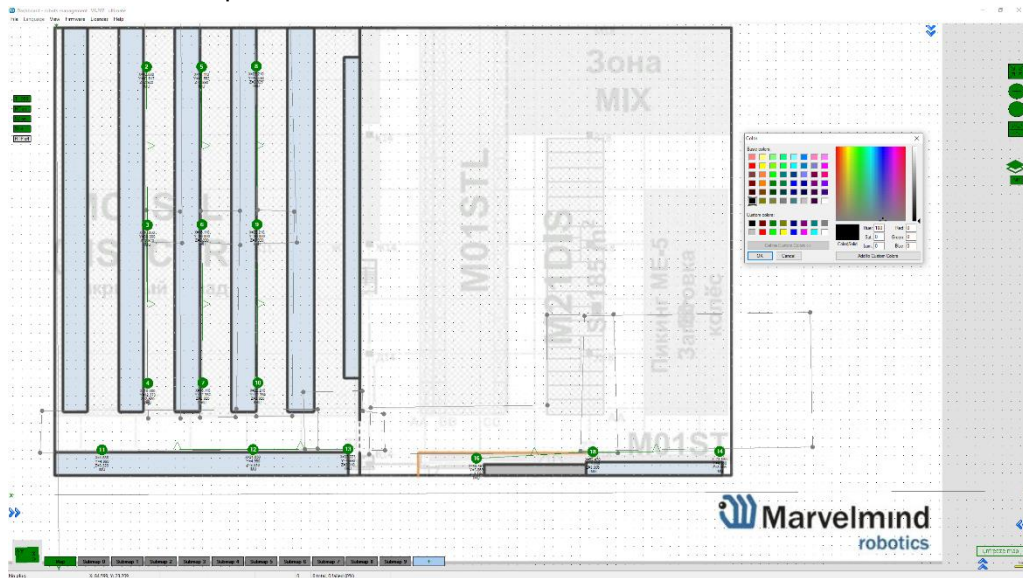

- Color applied. Now, background matches floorplan

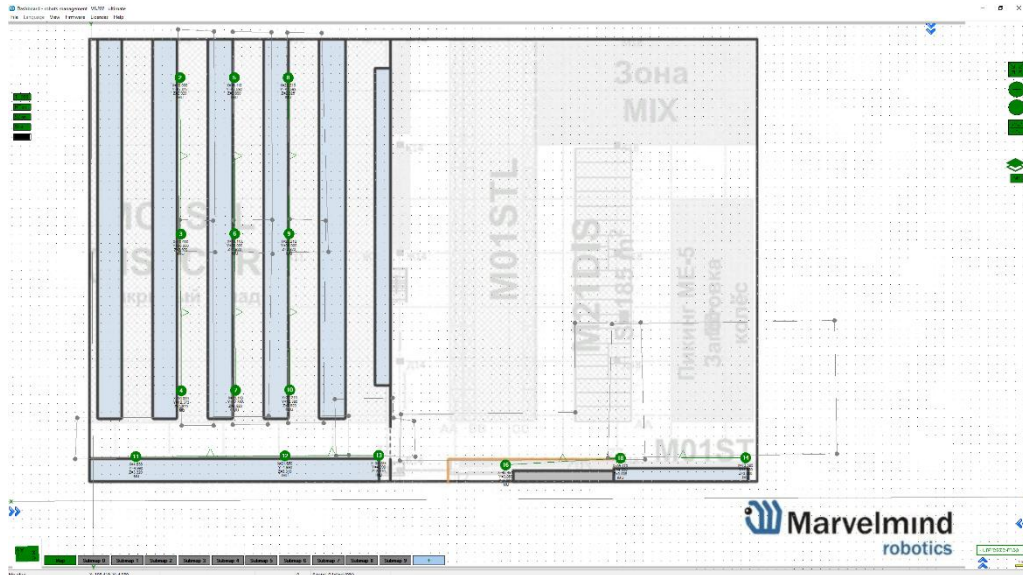

9.22. Hedge color change (FN0006)

If you have multiple mobile beacons, you can give each one its own color to make them recognizable on the map

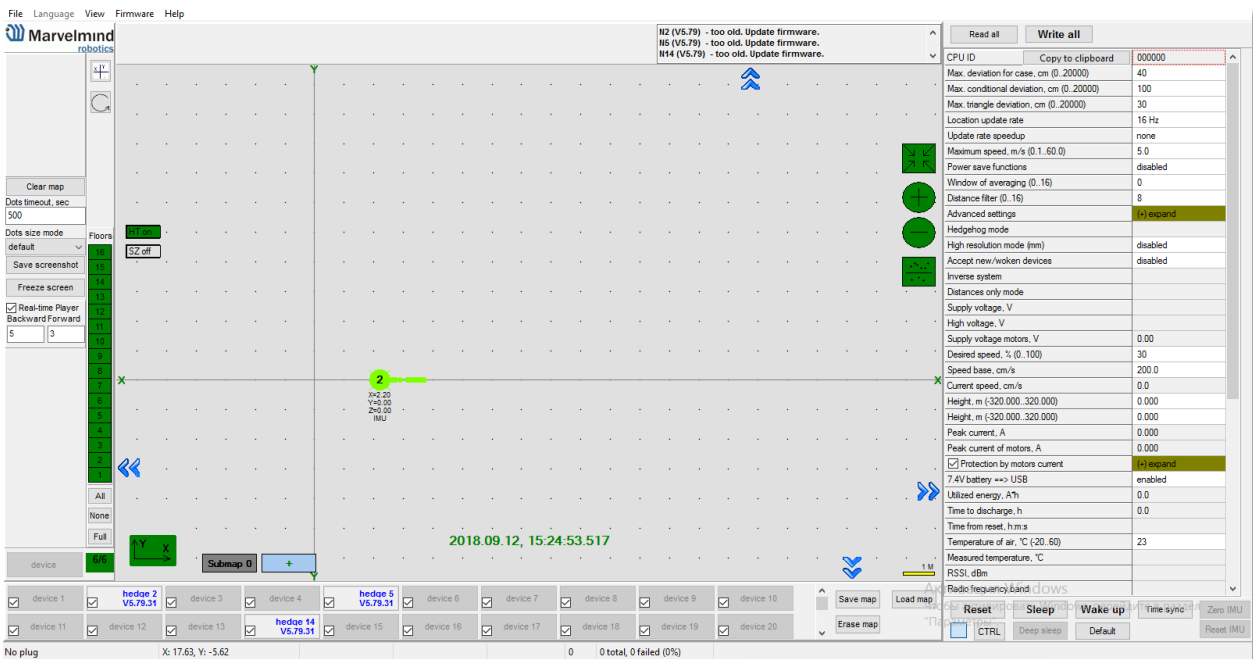

How to change hedgehog color:

- Right click on the hedge in the list of devices -> Setup color

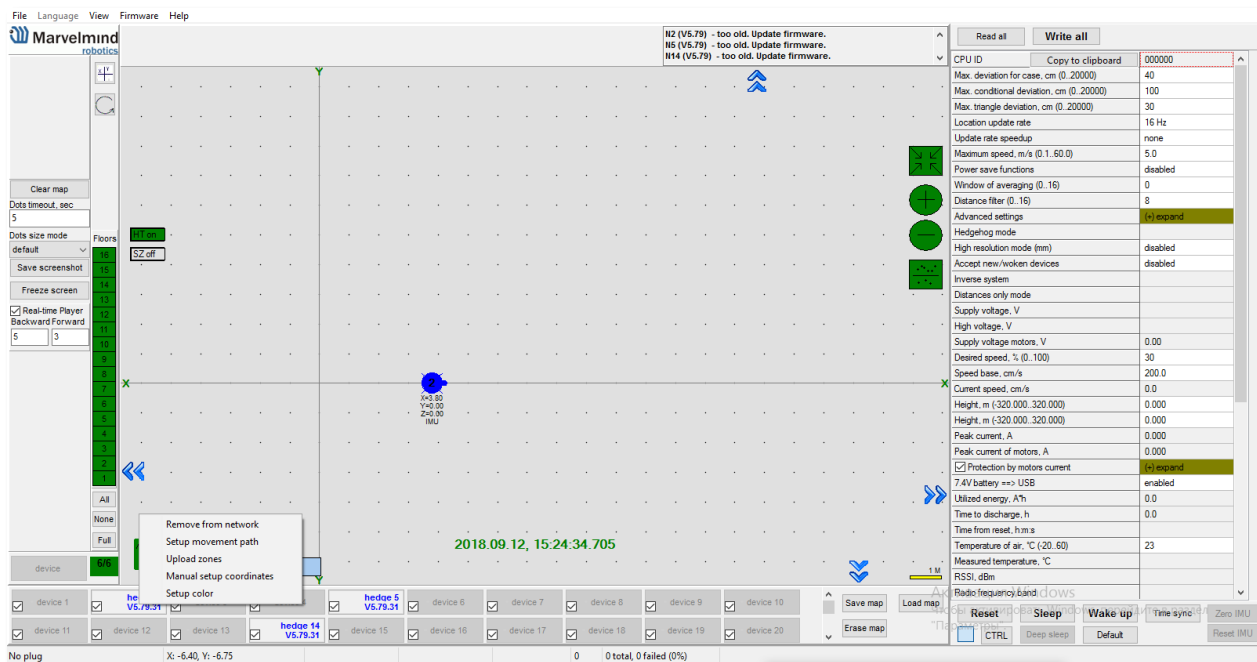

- Choose any color which suits you and press **OK**

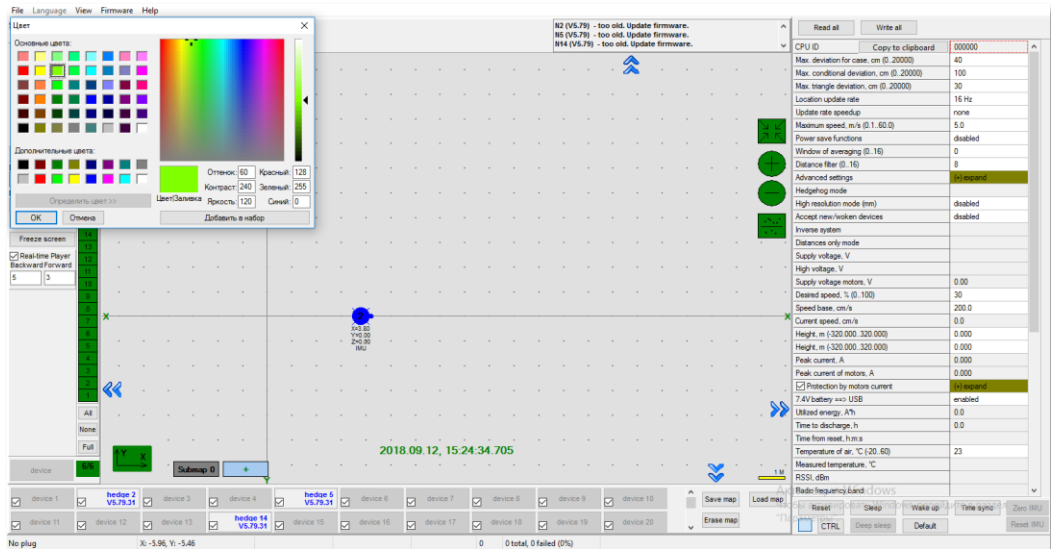

- Now, the hedgehog and its tracking path will be colored

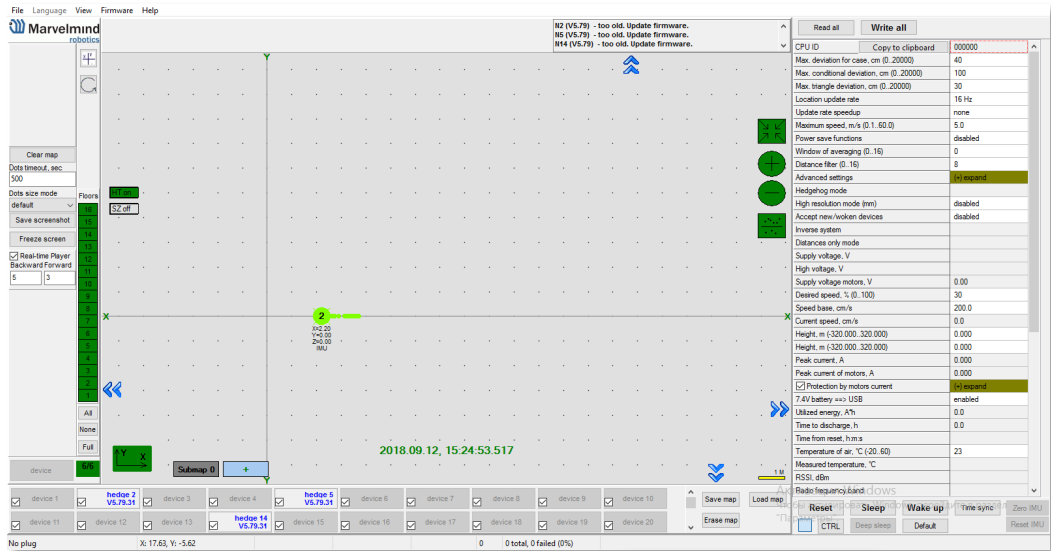

9.23. Payload streaming (FN0007)

Mobile beacon streaming user payload to modem. See the table with speed vs. payload

- All measurements were made with update rate setting 16 Hz. Real update rate is limited by distance, radio profile and payload data size.
- Additionally, with the MMSW0005 license the hedgehog payload is recorded in CSV format.

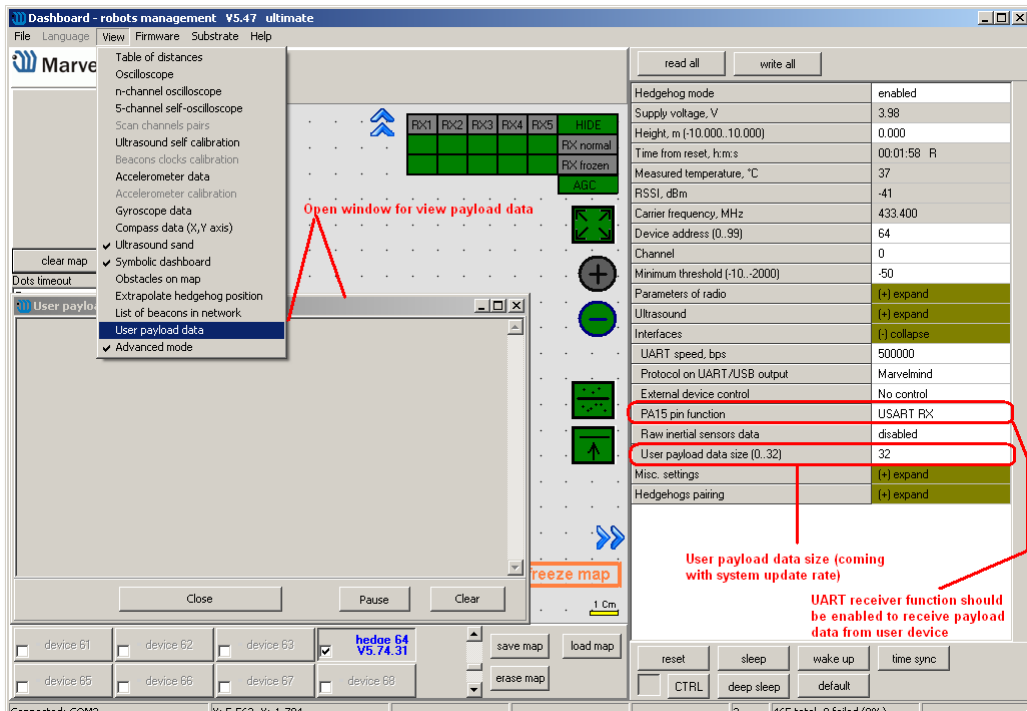

System configuration	Radio profile, kbps	User payload data per cycle, bytes	Real update rate, Hz	User payload maximum data rate (bytes per second)
2 stationary beacons, 3 meters maximum distance	500 (FEC)	0	16	0
		32	16	512
	153 (FEC)	0	16	0
		32	16	512
	38.4 (FEC)	0	9	0
		32	8	256
	38.4 (no FEC)	0	14	0
		32	13	416
4 stationary beacons, 11 meters distance	500 (FEC)	0	14	0
		32	14	448
	153 (FEC)	0	12	0
		32	12	384
	38.4 (FEC)	0	6	0
		32	6	192
	38.4 (no FEC)	0	9	0
		32	9	288

9.24. IMU feature (FN0008)

This function allows to increase data update rate received from ultrasound beacon with IMU due to sensor fusion up to 100 Hz, using inertial sensors (accelerometer, gyroscope).

9.24.1. Setup IMU feature

Accelerometer calibration

Required:

- Starter set
- Hedgehog with IMU
- SW and firmware version 5.85 or newer
- Ultrasound Update rate 4Hz or higher

Before you start use the feature check whether accelerometer has been calibrated

- Check if hedge was not calibrated before. Was damaged or fall down
- Put hedgehog on a flat surface (antenna directs up) and connect to your PC. Run the Dashboard
- Go to view => Accelerometer calibration in open window click autofill and clear table.

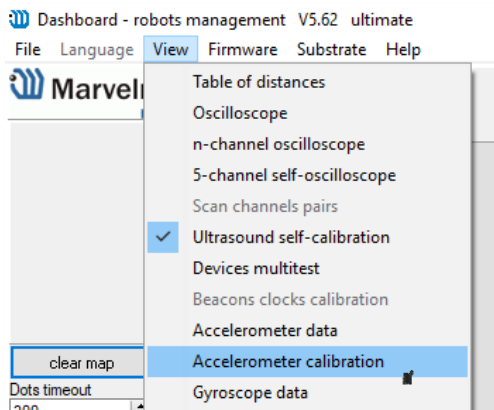

- After all values will refresh. Next, click Pause (shift + space)

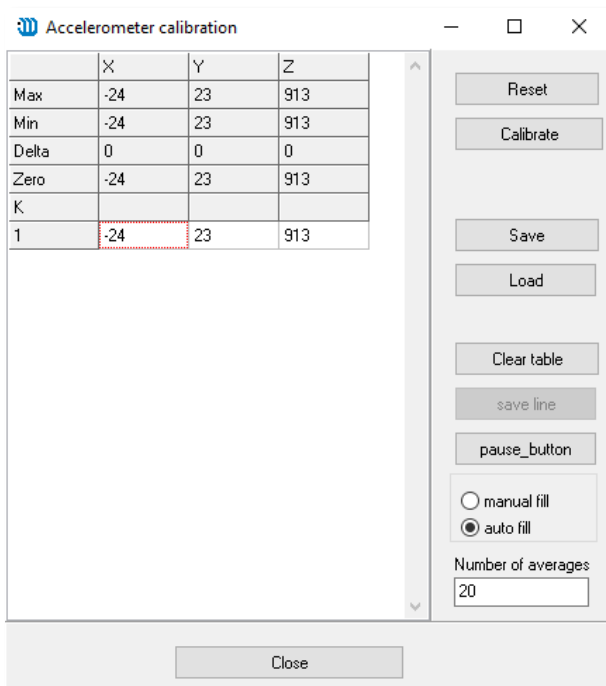

Then take the beacon (hedgehog) and tilt it to each side towards the ground (about 6 times). Rotate a little. You need to achieve x y z values:

- When antenna directs down $z \approx -1000$ => antenna directs up $z \approx 1000$
- So, one of the axis values always will be - + 1000. Others ≤ 10 (preferably less 10, but 25 is also permissible)
- Every time before calibrating the hedgehog click **Pause**
- Accelerometer calibrator will choose the best value for each axe. At the end click **Calibrate** and close the window
- Calibration is needed to determine **g** value for each accelerometer axe

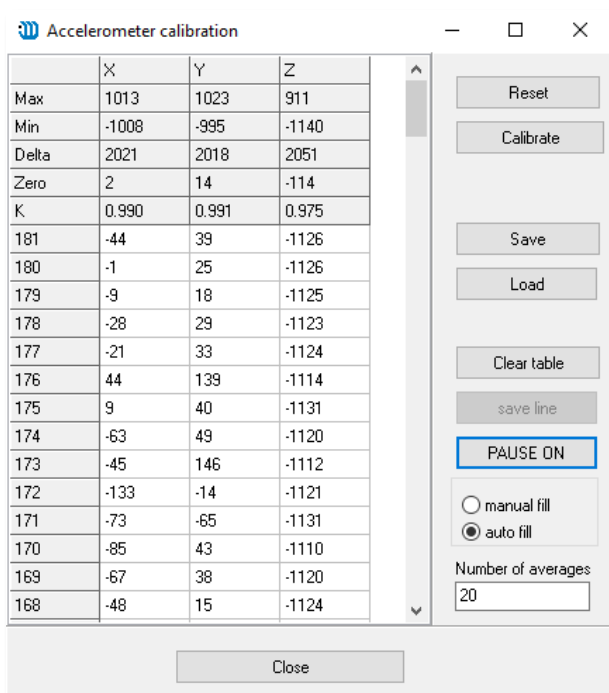

Start the system:



Setup the system as usual. It is described in paragraph [Setting up the system](#).

After the ultrasound tracking has started, select the hedgehog in the Dashboard, go to menu **Interfaces** (on the right) and enable **Processed IMU data**. After that, it is recommended to bring the hedgehog to real estate and press the ZERO IMU button (right-bottom) for additional sub-calibration of the gyro. After 5 seconds the hedgehog will begin streaming the processed IMU data.

9.24.2. Using Data in the Python Library Example

Description of the protocol for streaming data: [\(link\)](#)

To work with data, you need to use some ready-made library, or develop your own software tools that can work with the described protocol.

Our company provides ready-made libraries for working with IMU in the following languages:

- python [\(link\)](#)
- c ++ [\(link\)](#)
- java [\(link\)](#)



An example with 3D imaging of a path on IMU with a frequency of 100Hz in real time, here: <https://marvelmind.com/pics/marvelmind-imu-tracker.zip>

9.25. IMU axis positioning

Super-Beacon IMU axis positions



HW v4.9 IMU axis positions



Mini-TX IMU axis positions



Mini-RX beacon IMU axis positions



9.26. Player feature (FN0009)

This function is used to view the distance passed, the flight of the copter, etc. The player displays statistics on the maximum and average speed, the path traveled.

Starting with Dashboard v6.240, log files writes in .csv format

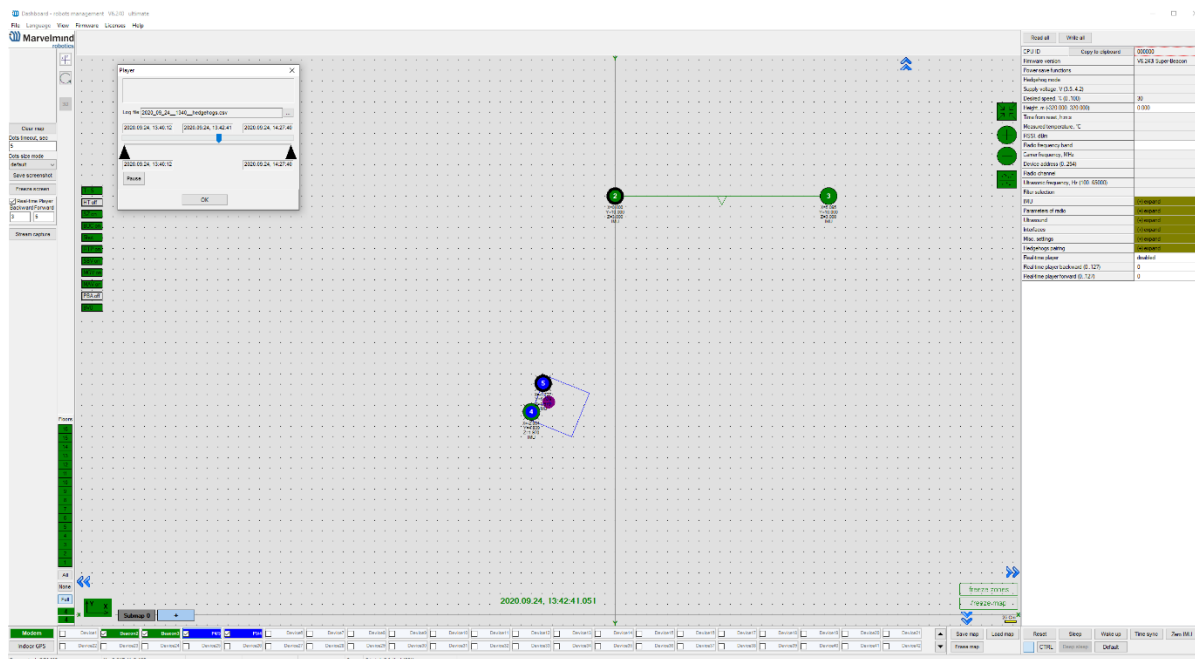

How to use Player:

- Go to File=>Player

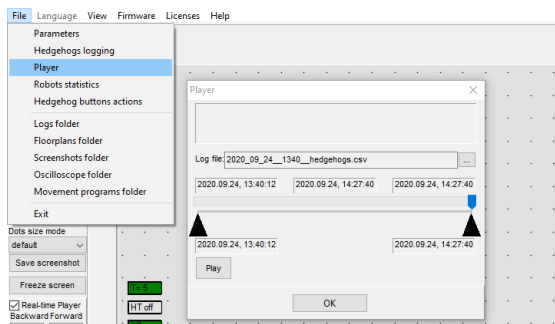

This is how the starting player menu looks like

Select log – opens save log file

Play – launch the playback

- Click **Select log** button and choose the file
- Now log is loaded. Important: for recording log file click **Save map** for saving all the beacons locations and attaching all the beacons to the log. Log file also created while Freeze map pressing.

At the top of the player you can see 7 outputs:

Currently playing time

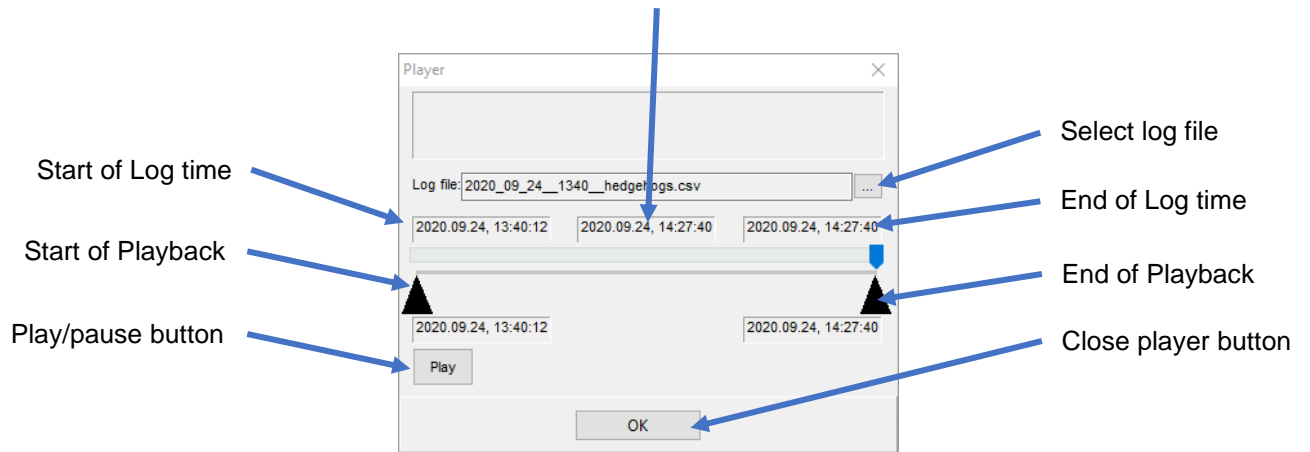

Limited area - distance between black triangles under slider. You can move triangles and zoom, place cursor on the slider + mouse wheel. Triangles limit the area in which player works and the statistics is calculated

9.27. Real-time player feature (FN0010)

Real-time player is a feature, which makes the tracking path smoother. As far as it looks backward and forward it certain latency based on the selected parameters.

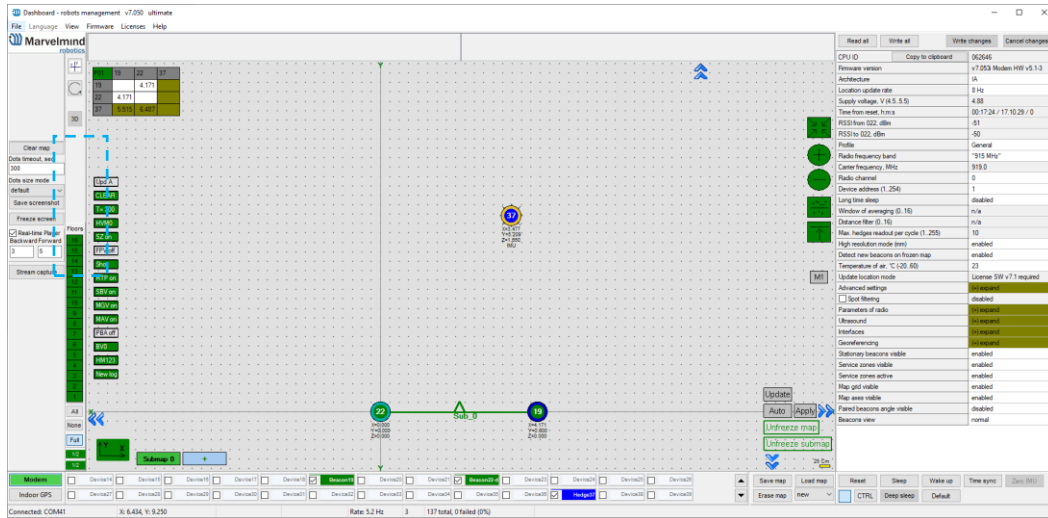

- Real-time player turned on by default

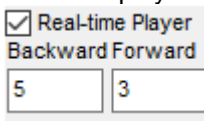

- You can turn it off if you need less delay

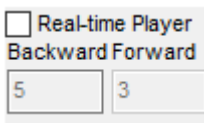

You can tune it whether you need:

- **Backward** – amount of dots which player 'looks' backward to provide smooth tracking
- **Forward** – amount of dots which player 'looks' forward to provide smooth tracking

Tracking examples:

- Real-time player **turned off**

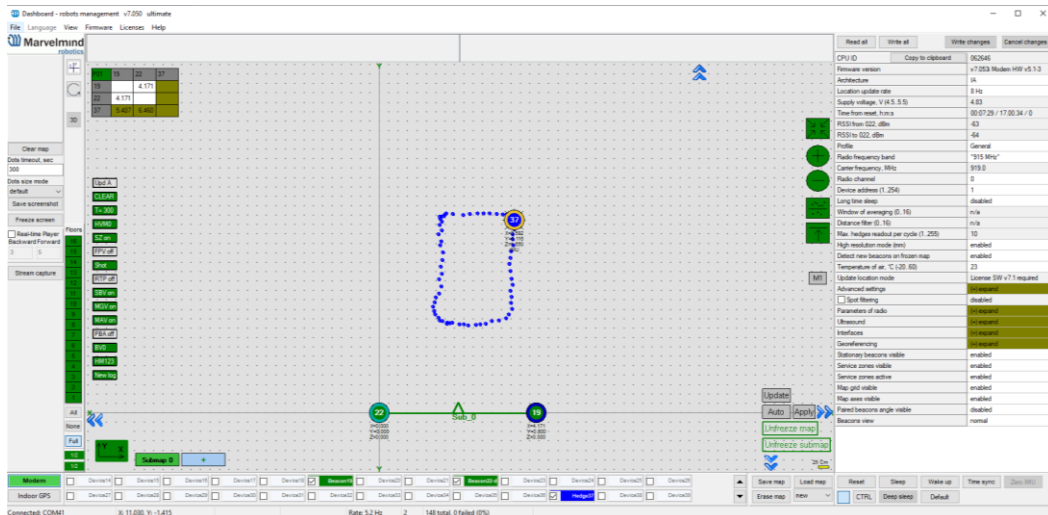

- Real-time player turned on

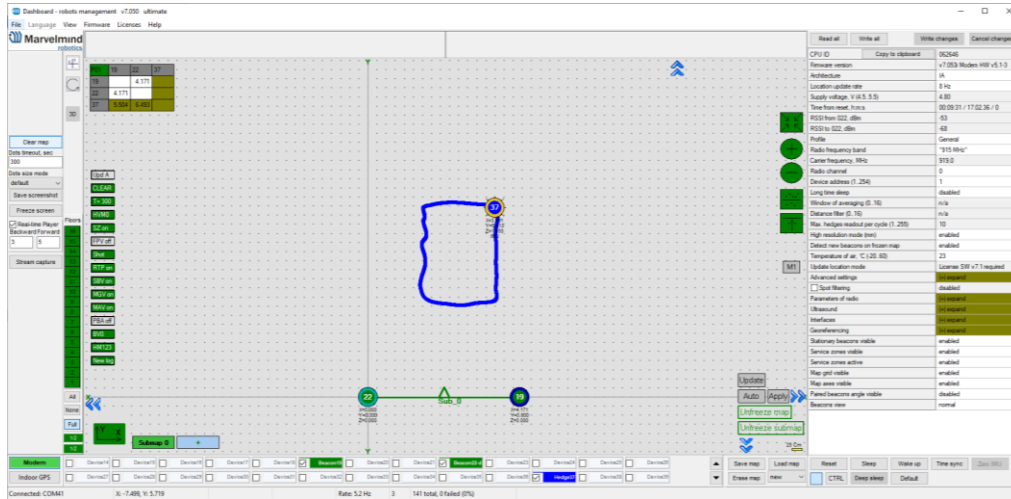

9.28. CSV format

Current Dashboard version supports additional timestamp. See the attached screenshot, the UNIX time in milliseconds is the first value.

In each line comma separated values, CSV:

- - UNIX time in milliseconds (time since 1970.01.01)
- - time from previous record in milliseconds
- - time from running dashboard in milliseconds
- - address of hedgehog
- - X coordinate of hedgehog, meters
- - Y coordinate of hedgehog, meters
- - Z coordinate of hedgehog, meters
- - address of stationary beacon
- - raw distance from hedgehog to stationary beacon, meters

The last pair (beacon address, distance) is repeated n times equal stationary beacons quantity in the system.

```

1494780417562,16,12287484,10,5.643,-0.553,0.453,12,6.343,13,3.169,14,9.814,15,5.841,
1494780417609,47,12287531,10,5.643,-0.553,0.453,12,6.343,13,3.169,14,9.814,15,5.841,
1494780417625,16,12287547,10,5.643,-0.552,0.466,12,6.343,13,3.169,14,9.814,15,5.841,
1494780417687,62,12287609,10,5.643,-0.552,0.466,12,6.343,13,3.169,14,9.814,15,5.841,
1494780417703,16,12287625,10,5.643,-0.552,0.466,12,6.343,13,3.169,14,9.814,15,5.841,
1494780417703,0,12287625,10,5.643,-0.552,0.466,12,6.343,13,3.169,14,9.814,15,5.841,
1494780417750,47,12287672,10,5.646,-0.550,0.466,12,6.343,13,3.169,14,9.814,15,5.841,
1494780417812,62,12287734,10,5.646,-0.550,0.466,12,6.343,13,3.171,14,9.811,15,5.840,
1494780417812,0,12287734,10,5.646,-0.550,0.466,12,6.343,13,3.171,14,9.811,15,5.840,
1494780417843,31,12287765,10,5.646,-0.550,0.466,12,6.343,13,3.171,14,9.811,15,5.840,
1494780417875,32,12287797,10,5.642,-0.553,0.466,12,6.343,13,3.171,14,9.811,15,5.840,
1494780417875,0,12287797,10,5.642,-0.553,0.466,12,6.343,13,3.171,14,9.811,15,5.840,
1494780417937,62,12287859,10,5.642,-0.553,0.466,12,6.347,13,3.172,14,9.813,15,5.837,
1494780417968,31,12287890,10,5.642,-0.553,0.466,12,6.347,13,3.172,14,9.813,15,5.837,
1494780418031,63,12287953,10,5.649,-0.551,0.466,12,6.338,13,3.171,14,9.813,15,5.843,
1494780418078,47,12288000,10,5.649,-0.551,0.466,12,6.338,13,3.171,14,9.813,15,5.843,
1494780418140,62,12288062,10,5.642,-0.553,0.466,12,6.338,13,3.171,14,9.813,15,5.843,
1494780418140,0,12288062,10,5.642,-0.553,0.466,12,6.338,13,3.171,14,9.813,15,5.843,
1494780418171,31,12288093,10,5.642,-0.553,0.466,12,6.463,13,3.169,14,9.813,15,5.837,
1494780418203,32,12288125,10,5.642,-0.553,0.466,12,6.463,13,3.169,14,9.813,15,5.837,
1494780418265,62,12288187,10,5.648,-0.551,0.459,12,6.463,13,3.169,14,9.813,15,5.837,
1494780418312,47,12288234,10,5.648,-0.551,0.459,12,6.345,13,3.172,14,9.813,15,5.844,
1494780418375,63,12288297,10,5.651,-0.549,0.459,12,6.345,13,3.172,14,9.813,15,5.844,
1494780418375,0,12288297,10,5.651,-0.549,0.459,12,6.345,13,3.172,14,9.813,15,5.844,
1494780418390,15,12288312,10,5.651,-0.549,0.459,12,6.346,13,3.171,14,9.812,15,5.846,
1494780418421,31,12288343,10,5.651,-0.549,0.459,12,6.346,13,3.171,14,9.812,15,5.846,
1494780418468,47,12288390,10,5.651,-0.549,0.459,12,6.346,13,3.171,14,9.812,15,5.846,
1494780418468,0,12288390,10,5.651,-0.549,0.459,12,6.346,13,3.171,14,9.812,15,5.846,
1494780418546,78,12288468,10,5.651,-0.552,0.459,12,6.346,13,3.175,14,9.812,15,5.846,
1494780418546,0,12288468,10,5.651,-0.552,0.459,12,6.346,13,3.175,14,9.812,15,5.846,
1494780418593,47,12288515,10,5.651,-0.552,0.459,12,6.346,13,3.175,14,9.812,15,5.846,

```

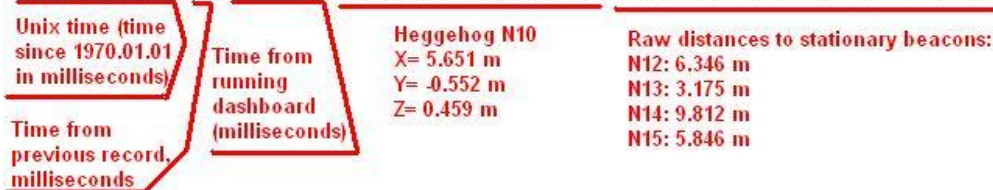

10. Interfaces

Indoor “GPS” system supports many external interfaces that can feed measured location data to an external system (robot, copter, VR, etc.).

There are two different ways to obtain the mobile beacons’ location data from the system:

- **From the mobile beacons**
 - Each mobile beacon knows its own position and does not know the positions of the other mobile beacons
- **From modem/router**
 - Knows position of every mobile beacon in the system

Data from the mobile beacons and from the modem can be obtained at the same time, if necessary

Starting from software version v7.200 real-time timestamps are enabled by default. If you need an old streaming format with local timestamps for compatibility with older software, you can disable this option in the device settings in the dashboard:

UART speed, bps	500000
Protocol on UART/USB output	Marvelmind
Raw distances data	disabled
Quality and extended location data	disabled
Telemetry stream	disabled
Telemetry interval, sec (1..255)	n/a
User payload packets number (0..31)	0
Alarm pin function	MMSW0006 required
Alarm pin mode	n/a
PB5 pin function	None
Streaming mode	Normal
Debugging data	disabled
SPI data output	n/a
Stream realtime timestamps	enabled

A list of the supported interfaces is shown below.



More information on the interfaces can be found here:
https://marvelmind.com/pics/marvelmind_interfaces.pdf

Supported interfaces

- **Mobile beacon:**
 - UART
 - SPI
 - Virtual UART via USB
 - NMEA
- **Modem:**
 - UART
 - SPI
 - Virtual UART via USB
- **Integrated with:**
 - Windows (PC & tablets)
 - Linux
 - Mac OS
 - Android (beacon)
 - ROS (beacon)
 - Raspberry (beacon)
 - Arduino (beacon)
 - PixHawk (beacon)
- **Sample code:**
 - C
 - Python

10.1. Super-beacon external interface pinout top view

4x4 pinout for Super-Beacon:

- - External pins
- - Internal solderable contacts

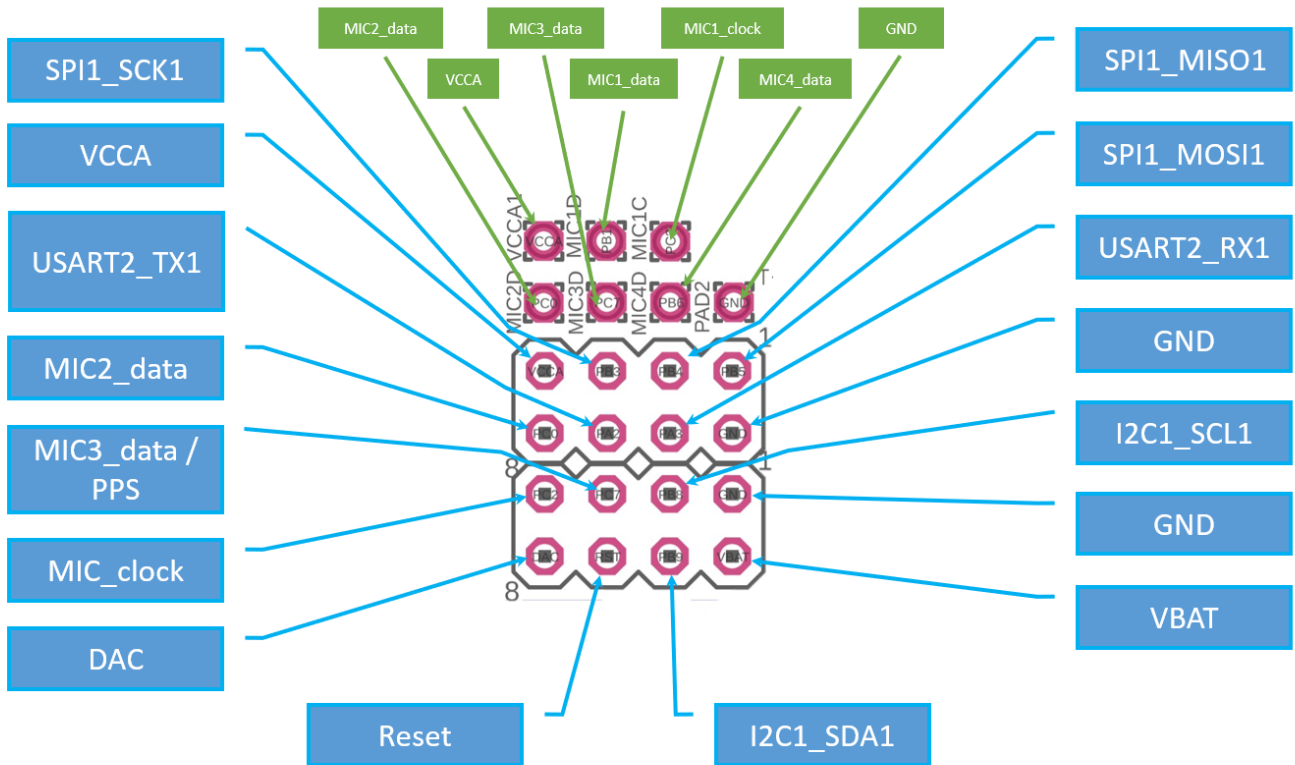

4x4 pinout for Super-Beacon-2:

- - External pins
- - Internal solderable contacts

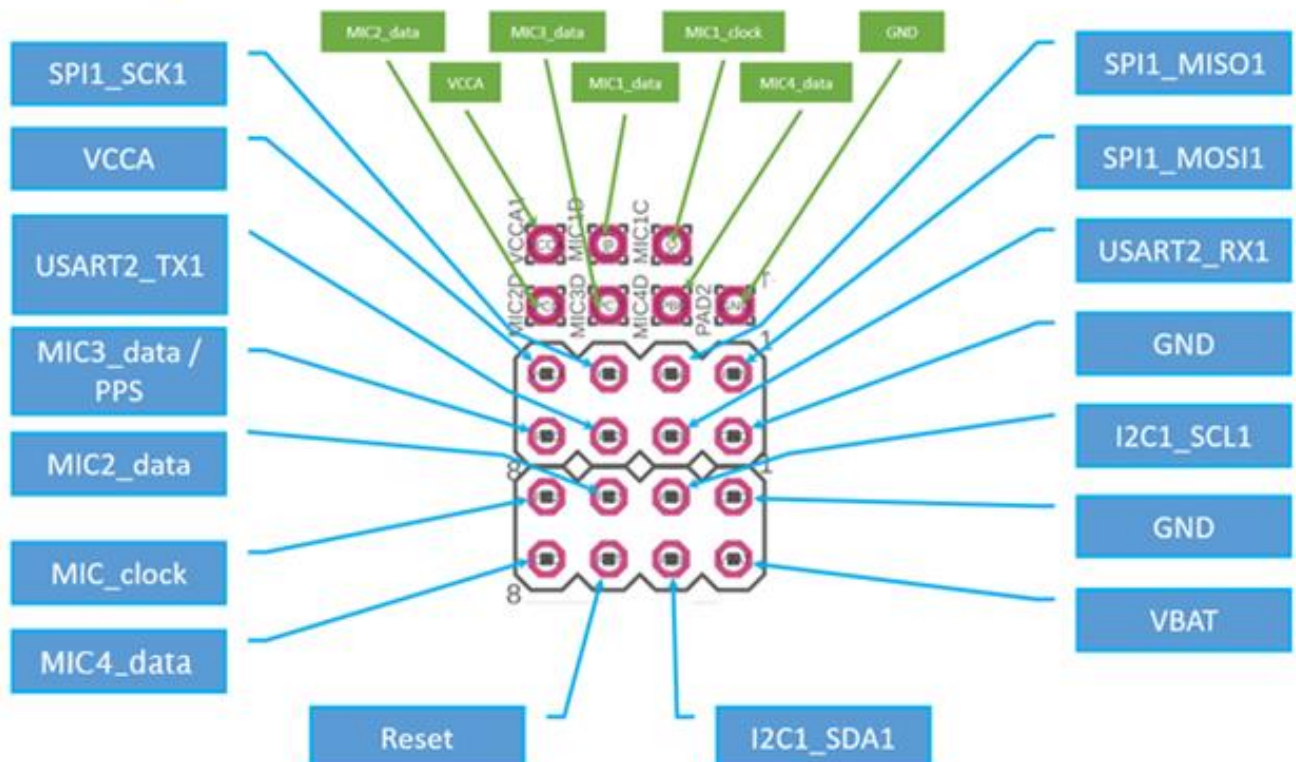

10.2. Beacon HW v4.9 external interface 4x4 pinout top view

Beacon HW v4.9 external interface 4x4 pinout

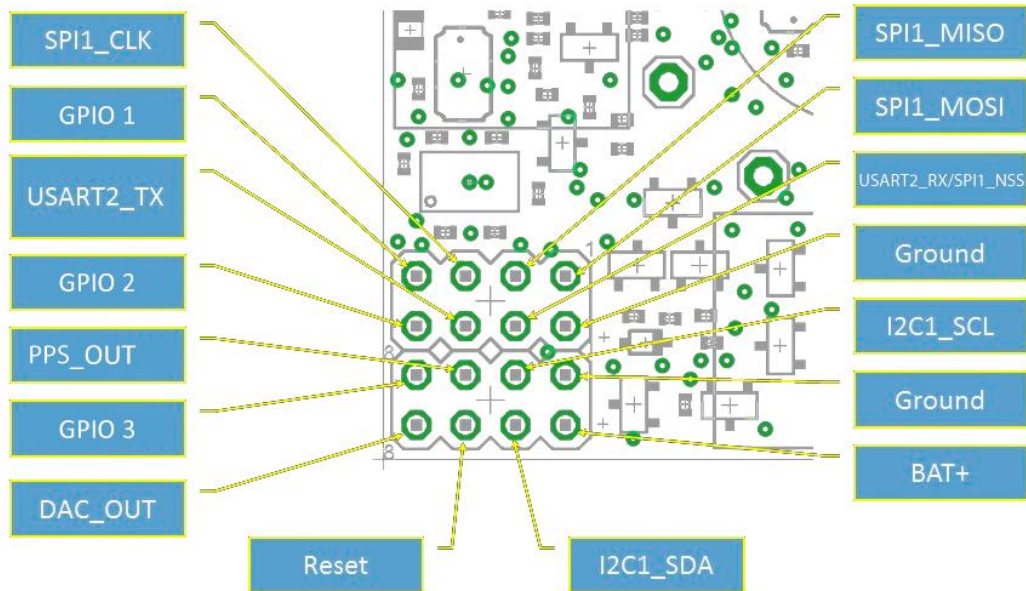

10.3. Modem HW v4.9 external interface pinout top view

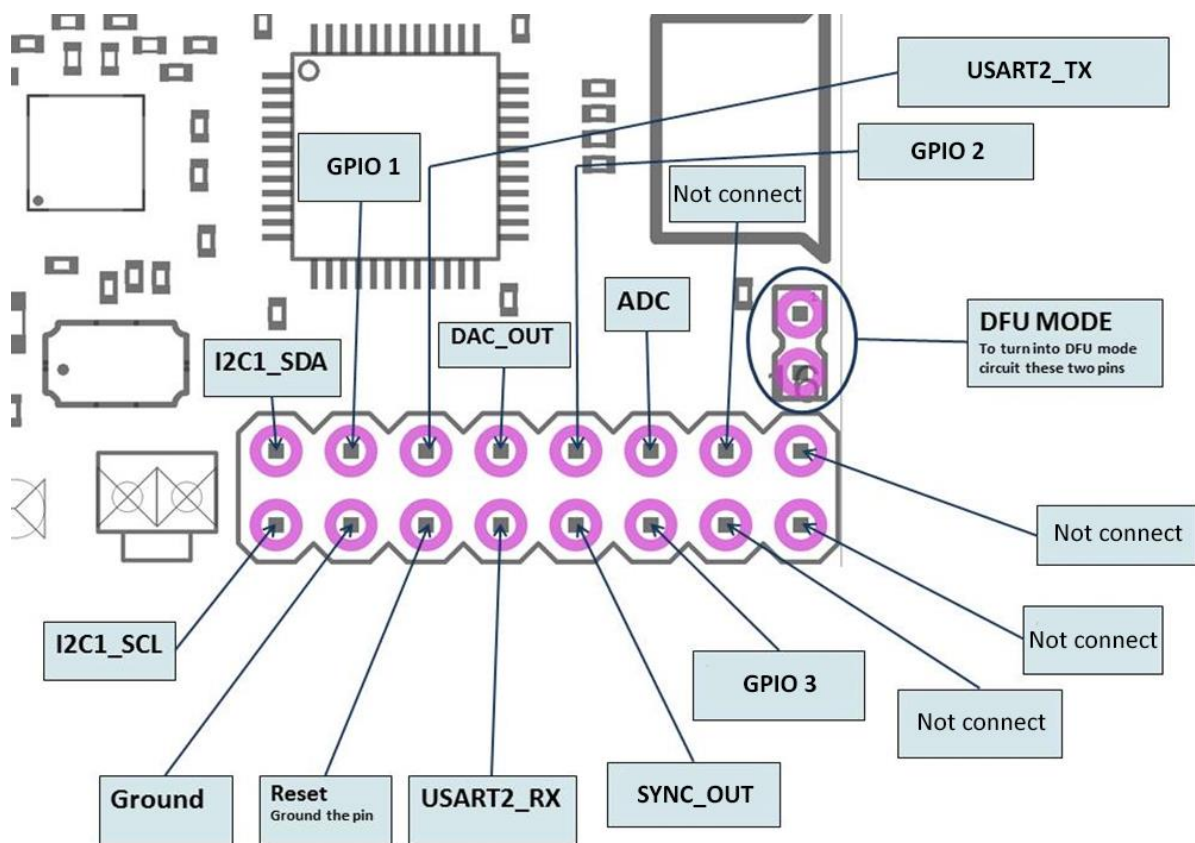



10.4. Mini-RX internal solderable pinouts (for experienced users only)



Use it only if you are sure that you can solder it correctly

Do not forget to turn off the beacon with DIP-switches

If you solder bad and kill the beacon, Marvelmind team won't be responsible for it

To get UART data streaming from beacon Mini-RX, you must solder to the pins on the

Mini-RX internal solderable pinouts

● - Internal solderable contacts

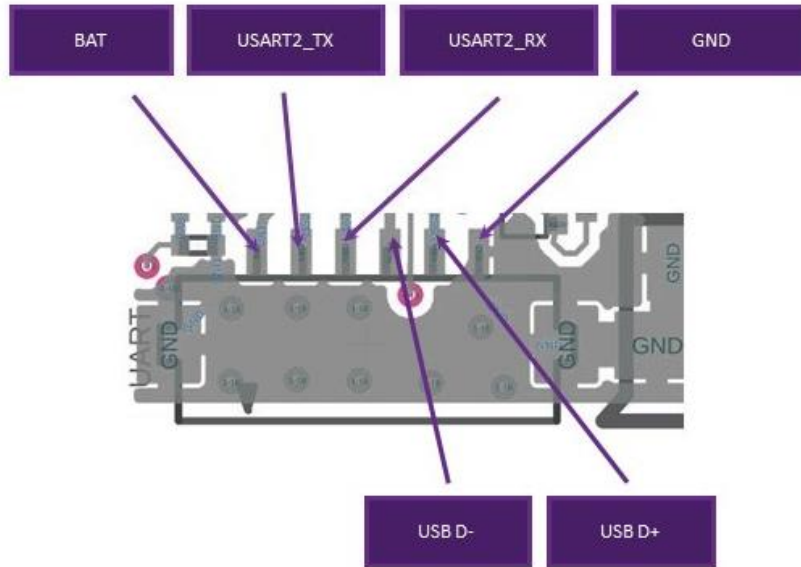



11. Advanced system settings and optimization

Start using advanced settings only when you are confident with the system.

If you run into trouble, connect the beacon or modem to the PC via USB and use the **DEFAULT** button. It will upload “factory settings” to the board while keeping the device address untracked.

Carrier frequency, MHz	433.400
Device address (0..99)	1
Channel	0
Parameters of radio	(+) expand
Interfaces	(+) expand
Georeferencing	(+) expand
Limitation distances	auto
Service areas visible	enabled
Service areas active	enabled
Submap X shift, m (-100.00..100.00)	0.00
Submap Y shift, m (-100.00..100.00)	0.00
Submap rotation, degrees (-360.00..360.00)	0.00

Аktivация Windows

reset sleep wake up time sync

CTRL deep sleep default

11.1. Radio Profiles compatibility

In this section we present different HW versions of different products

	38 Kbps	100 Kbps	400 Kbps *	500 Kbps
Modem HW v4.9	Supports	Supports	Doesn't Support**	Supports
Modem HW v5.1	Supports	Supports	Supports	Supports
Modem HW v5.1-3	Supports	Supports	Doesn't Support**	Doesn't Support**
Super-Modem	Supports	Supports	Supports	Supports
Super-Modem-2	Supports	Supports	Supports	Supports
Super-Modem-3	Supports	Supports	Doesn't Support**	Doesn't Support**
Beacon Mini-RX	Supports	Supports	Supports	Supports
Beacon Mini-RX-2	Supports	Supports	Supports	Supports
Beacon Mini-RX-3	Supports	Supports	Doesn't Support**	Doesn't Support**
Super-Beacon	Supports	Supports	Supports	Supports
Super-Beacon-2	Supports	Supports	Supports	Supports
Super-Beacon-3	Supports	Supports	Doesn't Support**	Doesn't Support**
Industrial Super-Beacon	Supports	Supports	Supports	Supports
Industrial Super-Beacon-2	Supports	Supports	Doesn't Support**	Doesn't Support**
Industrial Super-Beacon-3	Supports	Supports	Doesn't Support**	Doesn't Support**
Beacon HW v4.9	Supports	Supports	Doesn't Support**	Supports
Beacon Mini-TX	Supports	Supports	Doesn't Support**	Supports

*400 kbps is used in Japan instead 500 kbps

**Won't be available, because of specific radio chip configuration

Examples of different configurations

Starter Sets consist of different devices, so you check what types of devices you have and it will depend on which radio profiles you can use

Example 1 – Modem HW v5.1 and Super-Beacon-2

	38 Kbps	100 Kbps	400 Kbps *	500 Kbps
Modem HW v5.1	Supports	Supports	Supports	Supports
Super-Beacon-2	Supports	Supports	Supports	Supports

From this table we can see that in this configuration you can use all profiles, because both devices support them.

Example 2 – Modem HW v.5.1 and Super-Beacon-3

	38 Kbps	100 Kbps	400 Kbps *	500 Kbps
Modem HW v5.1	Supports	Supports	Supports	Supports
Super-Beacon-3	Supports	Supports	Doesn't Support	Doesn't Support

From this table we can see that in this configuration you can use 38 kbps and 100kbps radio profiles, because Super-Beacon-3 doesn't support 400 kbps and 500 kbps (Won't be available, because of specific processor configuration).

Example 3 – Modem HW v.5.1-3 and Beacon Mini-RX-3

	38 Kbps	153 Kbps	400 Kbps *	500 Kbps
Modem HW v5.1-3	Supports	Supports	Doesn't Support	Doesn't Support
Beacon Mini-RX-3	Supports	Supports	Doesn't Support	Doesn't Support

From this table we can see that in this configuration you can use 38 kbps and 100 kbps radio profiles, because Modem HW v5.1-3 and Beacon Mini-RX-3 don't support 400 kbps and 500 kbps (Won't be available, because of specific processor configuration).

Example 4 – Modem HW v.5.1, Super-Beacon-2 and Beacon Mini-RX-3

	38 Kbps	153 Kbps	400 Kbps *	500 Kbps
Modem HW v5.1	Supports	Supports	Supports	Supports
Super-Beacon-2	Supports	Supports	Supports	Supports
Beacon Mini-RX-3	Supports	Doesn't Support yet*	Doesn't Support	Doesn't Support

From this table we can see that in this configuration you can use 38 kbps and 100 kbps radio profiles, because Beacon Mini-RX-3 doesn't support 400 kbps and 500 kbps (Won't be available, because of specific processor configuration).



11.2. Wi-Fi settings for Super-Modem

You can use Wi-Fi for coordinate streaming to other PC. In this chapter we explain how to do that.

11.2.1. Wi-Fi settings menu in Dashboard

- When Super-Modem connected to PC via USB, expand “Wi-Fi/UDP settings” in settings bar.

Wi-Fi/UDP settings	Write	(-) collapse
Wi-Fi		enabled
Wi-Fi network name		faberge_DIR
Wi-Fi network password		*****
Show password		disabled
<input checked="" type="checkbox"/> Wi-Fi reconnect timeout, sec (10..65000)		120
Wi-Fi RSSI, dBm		n/a
Own IP address		n/a
UDP destination IP address		192.168.1.101
UDP destination port (0..65535)		49100

- Enable Wi-Fi

Wi-Fi/UDP settings	Write	(-) collapse
Wi-Fi		disabled

- Insert Wi-Fi network name and Wi-Fi network password of your wireless connection and press “Write” button

Wi-Fi/UDP settings	Write	(-) collapse
Wi-Fi		enabled
Wi-Fi network name		TP-Link_27EB
Wi-Fi network password		*****
Show password		enabled
<input checked="" type="checkbox"/> Wi-Fi reconnect timeout, sec (10..65000)		120
Wi-Fi RSSI, dBm		n/a
Own IP address		n/a
UDP destination IP address		192.168.1.101
UDP destination port (0..65535)		49100

- After this, “Wi-Fi/UPD settings” bar turns to green and shows your network name.

Wi-Fi/UDP settings	Write	(-) TP-Link_27EB
Wi-Fi		enabled
Wi-Fi network name		TP-Link_27EB
Wi-Fi network password		52268205
Show password		enabled
<input checked="" type="checkbox"/> Wi-Fi reconnect timeout, sec (10..65000)		120
Wi-Fi RSSI, dBm		-52
Own IP address		192.168.1.104
UDP destination IP address		192.168.1.101
UDP destination port (0..65535)		49100

- Insert UDP destination IP address and UDP destination port of device to which you will stream coordinates and press write button.

Wi-Fi/UDP settings	Write	(-) TP-Link_27EB
Wi-Fi		enabled
Wi-Fi network name		TP-Link_27EB
Wi-Fi network password		52268205
Show password		enabled
<input checked="" type="checkbox"/> Wi-Fi reconnect timeout, sec (10..65000)		120
Wi-Fi RSSI, dBm		-52
Own IP address		192.168.1.104
UDP destination IP address		192.168.1.101
UDP destination port (0..65535)		49100

- Wi-Fi settings completed.

11.2.2. Static IP

- When Wi-Fi enabled, enable Static IP and wait around 10 sec:

Advanced settings	(+) expand
<input type="checkbox"/> Spot filtering	disabled
Parameters of radio	(+) expand
Ultrasound	(+) expand
Interfaces	(+) expand
Georeferencing	(+) expand
Wi-Fi/UDP settings	Write (-) faberge_LTE_2.4GHz
Wi-Fi	enabled
Wi-Fi network name	faberge_LTE_2.4GHz
Wi-Fi network password	*****
Show password	disabled
<input checked="" type="checkbox"/> Wi-Fi reconnect timeout, sec (10..65000)	120
Static IP	disabled
Static IP address	n/a
Router IP address	n/a
Wi-Fi RSSI, dBm	-49
Own IP address	192.168.1.111
UDP destination IP address	192.168.1.101

- Enter IP address in IPv4 format (An IPv4 address has the following format: **x . x . x . x** where x is called an octet and must be a decimal value between 0 and 255.) and IP address of router that using for Wi-Fi connection. Press Write button:

Wi-Fi/UDP settings	Write	(-) faberge_LTE_2.4GHz
Wi-Fi		enabled
Wi-Fi network name		faberge_LTE_2.4GHz
Wi-Fi network password		*****
Show password		disabled
<input checked="" type="checkbox"/> Wi-Fi reconnect timeout, sec (10..65000)		120
Static IP		enabled
Static IP address		
Router IP address		
Wi-Fi RSSI, dBm		-48
Own IP address		192.168.1.111
UDP destination IP address		192.168.1.101
UDP destination port (0..65535)		49100

- If everything done correctly, Own IP address will change:

Wi-Fi/UDP settings	Write	(-) faberge_LTE_2.4GHz
Wi-Fi		enabled
Wi-Fi network name		faberge_LTE_2.4GHz
Wi-Fi network password		*****
Show password		disabled
<input checked="" type="checkbox"/> Wi-Fi reconnect timeout, sec (10..65000)		120
Static IP		enabled
Static IP address		106.200.3.123
Router IP address		192.168.1.101
Wi-Fi RSSI, dBm		-47
Own IP address		106.200.3.123
UDP destination IP address		192.168.1.101
UDP destination port (0..65535)		49100
Stationary beacons visible		enabled
Service zones visible		enabled
Service zones active		enabled
Map grid visible		enabled
Map axes visible		enabled
Paired beacons angle visible		disabled
Beacons view		normal

- Static IP settings completed.

11.3. Building big maps in Inverse Architecture (IA)

! This chapter is applicable only for Inverse Architecture

11.3.1. Introduction

In this chapter we described building big maps in **IA**. It has differences from classic NIA map building because we have more than 1 ultrasonic frequency, and we need to make sure that they do not interfere with each other. Please, read carefully.

A **map** is a system unit that includes **submaps**, **stationary beacons** and **service zones** within which positioning of **mobile beacons** is ensured by ultrasonic signals from the stationary beacons of this submap.

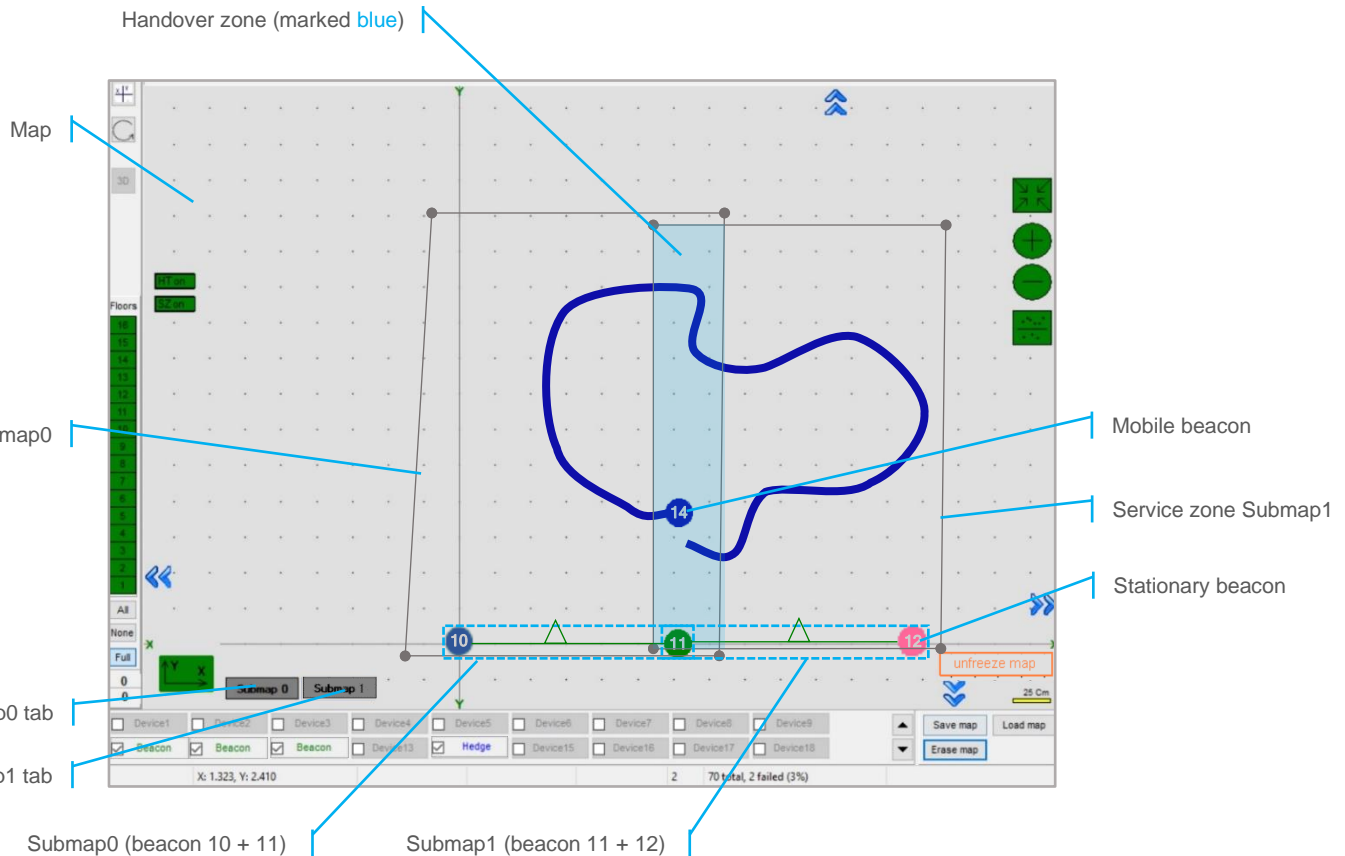

The main parameters of a submap are its **size**, **frequencies** and **TDMA position** of stationary beacons, by which mobile beacons can not only be positioned, but also determine in which submap the mobile beacon is located.

Check before start:



[8 basic steps from unpacking to autonomous drive/flight](#)



[Step-by-step guide on how to build complex maps](#)

Detailed explanation of complex map building:

[Building submaps: Part 1](#)

[Building submaps: Part 2](#)

11.3.2. TDMA sequence:

As far as we have only 5 ultrasonic frequencies, when we build big maps and when ultrasonic signals may interrupt each other, we must use TDMA. In this case submaps that cannot be used together will work alternately. Please notice that update rate falls by a multiple of TDMA sequence. If you have 8Hz basic update rate without using TDMA, 3 TDMA sequences will make it 8/3Hz.

TDMA is the mode of sequential radiation, when for each stationary beacon the number of the cycle in which it should emit and the number of cycles of radiation after which these numbers are repeated is set

We have 3 TDMA types:

- **Type 1** - TDMA as NIA multiple beacons' working algorithm
- [Type 2 - Full-overlapping TDMA \(For better coverage in 2D\). See more on TDMA chapter](#)
- **Type 3** - TDMA for huge IA maps building (described below)

For building huge maps in IA, we need **TDMA Type 3**.

- Example 1:

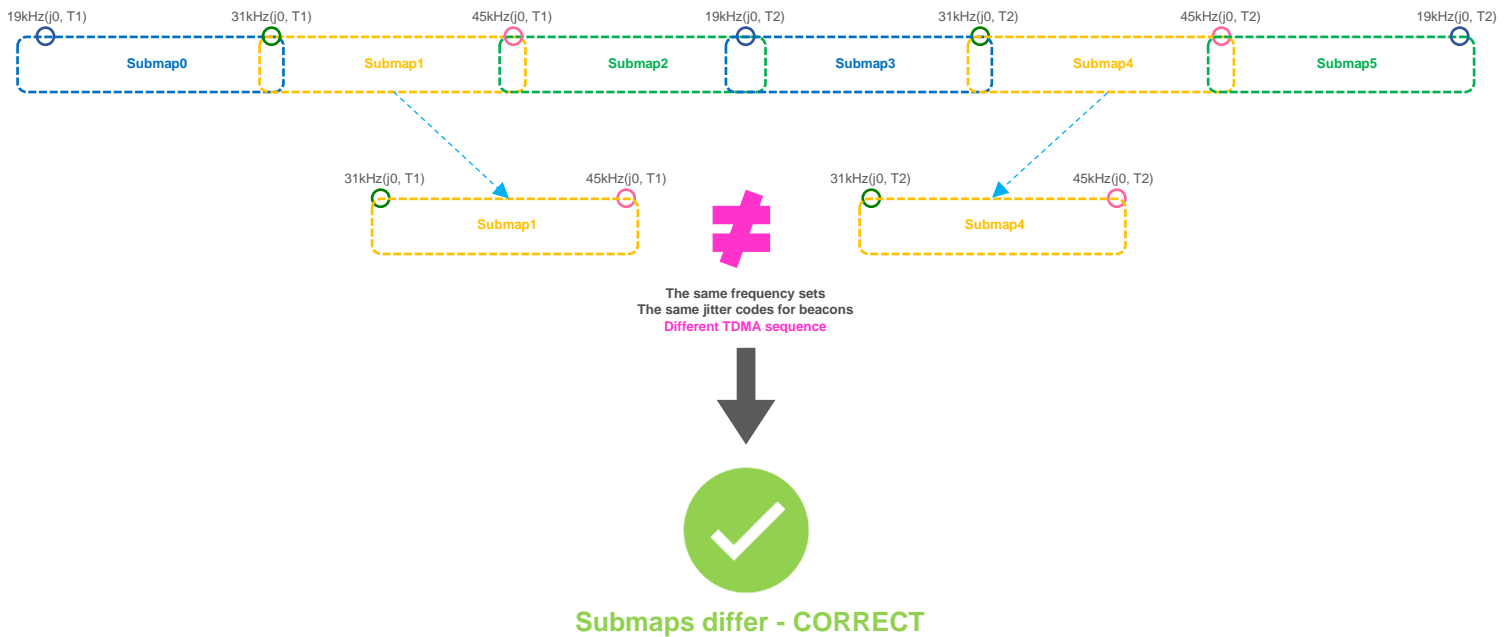

- Example 2:

For example, a **100x100 meter map in open-spaced area** consists of 55 submaps, the vertical rows of submaps are the same, but operate in different TDMA loops using **TDMA type 3**. In this example we used different colors for every TDMA position in sequence. TDMA 1(red) submaps emit first, TDMA 2(green) submaps emit second, TDMA 3(blue) submaps emit third:



Moreover, the map consists of $6 \times 11 = 66$ stationary beacons, i.e. 11 beacons of each of the frequencies combined into submaps: 19-31kHz, 31-45kHz, 45-19kHz, 19-37kHz, 37-25kHz.

11.3.3. TDMA Type 2 - Full-overlapping submaps

The steps below describe how to run IA with TDMA feature, which helps to improve the tracking quality in complex situations.

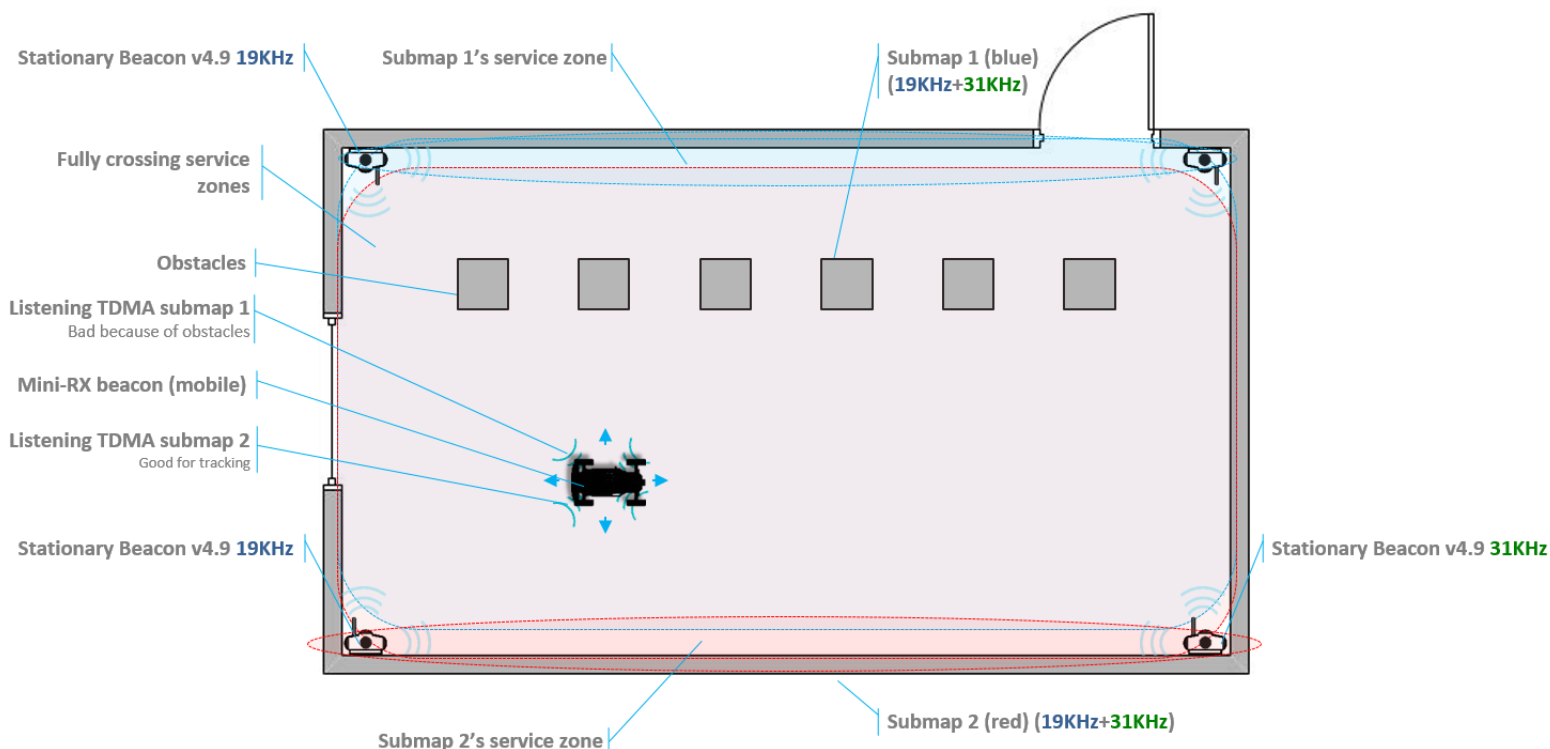

Suitable for IA only. Use IA Software



Stationary beacons should have different frequencies

When you work with two TDMA submaps, update rate reduces twice.



11.3.4. Mount stationary beacons in according to the TDMA chapters in [Placement manual](#).



11.3.5. Wake up beacons included in Submap0. Enter the values in the table “distance between beacons”, Freeze it. If necessary, set the shift, rotation, height, etc. Draw a service zone (More info: [Submaps feature](#) description).

11.3.6. Wake up beacons included in Submap1. If the submap uses beacons from other submaps, you must add them to the current one. Draw a service zone, fully crossing with Submap0’s service zone.

11.3.7. If submaps with the same set of frequencies intersect, it is necessary to use TDMA. (This is the mode of sequential radiation, when for each stationary beacon the number of the cycle in which it should emit and the number of cycles of radiation after which these numbers are repeated is set) For example, in the room there are beacons 19kHz, 45kHz and two 31kHz and submaps respectively 19kHz+31kHz and 31kHz+45kHz both include beacon 31kHz, therefore for all beacons the length of the TDMA sequence is set to 2, while the position in the TDMA sequence for beacons in 19kHz+31kHz submap is set to 0, and for beacons in 31kHz+45kHz submap is set to 1. As a result, the radiation of beacons in submaps occurs sequentially, first 19kHz+31kHz submap, then 31kHz+45kHz submap. You can also use absolutely the same set of frequencies in submaps (Submap0 = 19kHz+31kHz, Submap1 = 19kHz+31kHz)

	Duty, % (1..99)	50
	Number of periods (1..100)	24
	TDMA sequence length (1..8)	1
	TDMA position in sequence (0..7)	0
	Amplifier limitation (calibrated)	4000
	Amplification	AGC

11.3.8. Activate mobile beacons.

11.3.9. Freeze the entire map. Now, you can work with it.

11.3.10. If you have any jumps, that can mean that you have wrong submaps' positions. Unfreeze all and try to move it until you get their correct positions.

TDMA modes:

System supports two modes of TDMA:

- **Mode 1 (Adaptive):** Hedge determines which submap sees it better at the moment, and tracks in it. It can give better tracking, but in bad conditions, it may cause mistracking
- **Mode 2 (Classic):** Hedge tracks in two submaps one by one. It can give solid 50/50 tracking in conditions where one submap can't see the hedge at all. After measurements, Real-Time Player makes tracking smooth, filtering out mistracking

Each mode has its pros and cons. Try them both and choose the best suiting for your case.

How to change modes:

- Choose hedge
- Go to **Ultrasound -> TDMA mode**
- **Left Click** to change

Ultrasound	(-) collapse
Mode of work	Normal
Analog power in sleep	enabled
Power after transmission	turn off
Transmitter mode	PWM
Frequency, Hz (100..65000)	31000
Duty, % (1..99)	55
Number of periods (1..100)	33
TDMA mode	TDMA mode 1
Amplification	manual
Receiver amplifier (0..4095)	200
Time gain control	disabled
Mode of threshold	automatic

11.4. Increasing update rate

The update frequency is affected by 2 main parameters:

- 1) Radio profiles
- 2) Room dimensions (tracking areas)

If you need to tune the update rate of tracking, do the following:

- 1) Radio profiles:

There are 3 radio profiles available: 38kbps, 153kbps, 500kbps:

- **38kbps** is the slowest, but is able to cover a greater distance
- **153kbps** - average speed, overcomes the average distance (**default**)
- **500kbps** is the fastest, but works at a shorter distance

Accordingly, to raise the update rate, we recommend switching to 500kbps.

How to:

- In the settings bar of each device in the system (including modem), change the Radio profile parameter to **500kbps** (or any you need). It is situated in the Dashboard, on the right side of the Dashboard screen.

Tip: Change the beacons' profile before modem's, in order not to lose your beacons. It allows you to do it remotely

- 2) Room dimensions (tracking areas)

Update rate is also having linear dependence with tracking distance (distance between stationary and mobile beacon):

- **Longer** distance – **lower** update rate
- **Smaller** distance – **higher** update rate

If you have room 10x10m, change maximum distance setting. This will limit the system to the maximum measurement distance.

How to:

- Go to the submap settings (click on the submap icon)
- Change maximum distance value in meters (20 is a default)

Tip: Do not enter very small value, use 1-2 meter's margin. Also, do not use 20 meters if you have small tracking area. Tune carefully.

Learn more here: [How to increase location update rate?](#)

11.5. Reducing location update latency

Exact latency depends on many factors:

- IA or NIA
- From modem or from the beacon
- IMU sensor fusion or regular ultrasonic only
- Radio profile
- Realized update rate
- Any sort averaging or Real-time player enabled or not

The range is:

- ~ 12ms for data from a mobile beacon via USB with IMU fusion enabled and not averaging at all
- ~ 150ms with 30m-submap and update rate in ultrasonic of 7Hz and not averaging
- ~ 2 seconds with the same settings as in (b), but Real-Time Player with settings 16, i.e. it takes into account up to 16 previous readings before giving out the new one

What affects delay:

- [Real Time Player](#) in the Dashboard (For **NIA**)

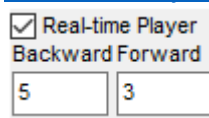

<input checked="" type="checkbox"/> Real-time Player
Backward Forward
5 3

- [Real Time Player in hedge](#) (For **IA**)

Real-time player	disabled
Real-time player backward (0..127)	3
Real-time player forward (0..127)	5

- Window of averaging and Distance filter settings in modem (For **NIA**)

Window of averaging (0..16)	4
Distance filter (0..16)	3

- Prefiltration coefficient and Ultrasonic filtering settings in hedge (For **IA**)

Prefiltration coefficient (0..127)	0
Ultrasonic filtering (0..255)	40

How to decrease latency:

- Turn off the [Real-Time Player](#) (works for **IA** and **NIA**)

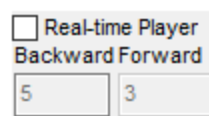

<input type="checkbox"/> Real-time Player
Backward Forward
5 3

- Change the *Window of averaging and Distance filter* settings value to 0 (**For NIA**):
- Choose **Modem** -> **Window of averaging** (in the right tab) -> **Enter 0 value**
- Choose **Modem** -> **Distance filter** (in the right tab) -> **Enter 0 value**

- Change the *Prefiltration coefficient* and *Ultrasonic filtering* settings value to 0 **(For IA)**:
- Choose your mobile beacon. Go to **Ultrasound -> Prefiltration coefficient -> Enter 0 value**
- Choose your mobile beacon. Go to **Ultrasound -> Ultrasonic filtering -> Enter 0 value**
- Complete. Latency reduced

Learn more here: [How to increase location update rate?](#)

11.6. How to Place Beacons

Avoid placing beacons on long sound-conducting objects

This is very rare but may happen under some special circumstances.

The best practice is to place beacons (stationary and mobile) in places that would not result in the transfer of ultrasound energy from the beacon's board/case directly to the place it is attached via a medium other than air. For example, solid attachment of a beacon to a long horizontal metal tube may result in the following:

- Sound emitted from the beacon propagates directly to the metal tube.
- Propagation losses inside metal are much smaller than in the air. Moreover, the tube may act as a low-loss waveguide.
- If the tube is solid enough and long enough, there may be an unusual effect where the receiving beacon receives the signal sooner than expected, i.e., sooner than the distance divided by the speed of sound in air. That happens because the speed of sound in metal is much higher than the speed of sound in the air. The ultrasound signal may even look stronger than the real signal propagated through the air due to the lower amount of losses of ultrasonic in metal than in the air.
- It is good practice to place beacons on something relatively soft or something that does not conduct sound.

Place beacons in a way that provides the proper ultrasonic coverage. It must be one beacon in the line of sight of minimum 2 beacons. Try to locate them under ceilings to avoid shadows, walls etc.

- Optimal settings for stationary beacons in small and big rooms.
- Use 30–50 ultrasonic pulses for larger places and the default 5 pulses for smaller places.
- Optimal settings for noisy environment.

There are several ways to reduce impact:

- Mobile beacons can be placed very close to the source of noise without harm, but stationary beacons should be placed further from the noise because they are receiving the ultrasound, whereas the mobile beacon is emitting the ultrasound.

Learn more about placing of the beacons here: [How to increase accuracy of precise indoor positioning system](#)

11.7. Using the Oscilloscope

- Monitor the ultrasonic signal from one beacon to another
- Use **Dashboard => View => Oscilloscope** to monitor ultrasonic signals from one beacon to another
- It is a very powerful tool, because it also gives information on the background noise, level of the signal, echo, etc. With this tool, it is easy to set up the proper ultrasonic threshold on the Dashboard.

Echo
External noises look similarly. Thus, choose the ultrasonic threshold below this value, for example, -500 to -2000

Type the reference beacon number and press Enter

Ultrasonic signal

Trigger (red line)

Emission counter

Choose the beacon

11.8. Proper Ultrasonic Signal Detection



This chapter mostly related to HW v4.9 beacons. Super-Beacons, Industrial Super-Beacons have high-power digital microphones for noise filtering and proper signal detection. Anyway, if you have problems with signal detection, read this chapter no matter which beacons do you use

These recommendations suitable only for NIA

Marvelmind Indoor Navigation System uses proprietary multi-frequency for ultrasonic signal and employs additional filtering to combat external noise. This also makes the system rather immune against the “usual suspects.” However, if the external noise is too strong, its source is too close, or it’s emitting a strong signal on frequencies close to 19, 25, 31, 37, 45kHz or white noise, the system functionality can be affected.

When external noise is high, identify the source. Usual sources include:

- Ultrasonic-based volume or movement detection alarm systems
- Other robots using ultrasonic
- Parktronics
- Sources of very strong white or impulse noise (air guns, air press, cutters, vacuum cleaner, etc.)
- Rotors of drones/copters

The best things to do in this case:

- Identify the beacons that are affected. Usually, they are those that are the closest to the source of noise. Try to reposition them
- Manually reduce the gain of the affected stationary beacons so that the signal from the mobile beacon would have a 1000–1800 amplitude. That would give the best signal-to-noise ratio. Don’t make the gain too high. The noise will be amplified, but the desired signal will be saturated and signal-to-noise ratio will be poor
- Input distances between beacons manually. More information – [Table of distances](#)

The gain settings may be very non-linear. There is almost no change at 4000 to 3000. But around 2500, the gain starts reducing very quickly (1200 – for some HW versions). By setting the gain manually, it is possible to find the optimal gain to obtain the highest signal to noise ratio so the system can work even in very challenging external conditions.

When the map is formed, only the mobile beacon is emitting, whereas stationary beacons are not. Thus, it does not matter how close the mobile beacon is to the source of the noise. However, it matters how close the stationary beacons are to those sources. Select the positions of the stationary beacons accordingly - place them further away from the noise sources.

11.9. Using hedgehog.log file

- The system automatically records all measured positions in the hedgehog.log file that is stored in the same folder as the Dashboard.exe file
- The data is written in csv format; each line describes the position of one of the hedgehogs at a certain moment
- The line format is described [here](#).



11.10. System Accuracy Evaluation

Accuracy of distance measurement:

- Marvelmind navigation system can measure distances between beacons with accuracy of +/- 2cm if correct ultrasound speed is used.
- The ultrasound speed depends on several factors: temperature, pressure, and humidity. Other factors have an insignificant effect.
- The main factor is temperature. In temperature range of -20...+50 °C the speed of ultrasound changes on about 0.6 m/ (s* °C). It gives distance error about $(0.6 / 340) * 100\% \sim 0.17\% / \text{°C}$. So caused by incorrect temperature setting absolute error of distance measurement is 0.17% of real distance between beacons. For example, with distance 30 meters and 5 °C error, this gives $0.85\% * 30 \sim 0.25$ meters' error. Marvelmind system allows to setup temperature of air in the system settings.

Accuracy of position measurement:

- Marvelmind system uses trilateration algorithm to calculate position by distances. The inaccuracy of position calculation is related to inaccuracy of distances measurement and to geometry of relative location of stationary and mobile beacons
- Basic trilateration formulas are given in this article: <https://en.wikipedia.org/wiki/Trilateration>
- As you see, the position of mobile beacons **X, Y, Z** is calculated from positions of 3 stationary beacons which are set by values of **d, i, j**. One of the beacons was shifted to (0,0) position to simplify formulas in the article. In formulas for **X, Y** we see **d** and **j** in denominators. This means that with low values of **d** and **j** small error of this value can cause significant position error
- Please see the picture of the beacons in the article - in more simple words, it means that if one of three beacons is close to line connecting other two beacons, it gives increased inaccuracy of locating mobile beacon

For example:

- assume $d= 10, i= 5, j= 0.1, r_1= 7, r_2= 7, r_3= 4.8$
- We get $x= 5, y= 2.4375, z = 4.25$
- If we suppose that $j=0.101$ (0.1 cm error), we receive $x= 5, y= -0.06, z= 4.89$
- You see very large Y error

Another example for Z. Assume mobile beacon is relative close to plane of stationary beacons:

- $d= 8, i= 4, j= 6, r_1= 5.02, r_2= 5.02, r_3= 3.01$
- This gives $X=4, Y= 3.01169, Z= 0.36$
- If we suppose $r_3= 3.0$ (1 cm error), we receive $X=4, Y= 3.016, Z= 0.44$. Error on Z is about 8 cm

Also, with $r_1= 5, r_2= 5, r_3= 3$, Z will be 0. As you see, low change of distances causes large change of Z value near the plane.

Learn more about accuracy here: [Absolute vs. relative accuracy](#)

11.11. Calibration of the accelerometer

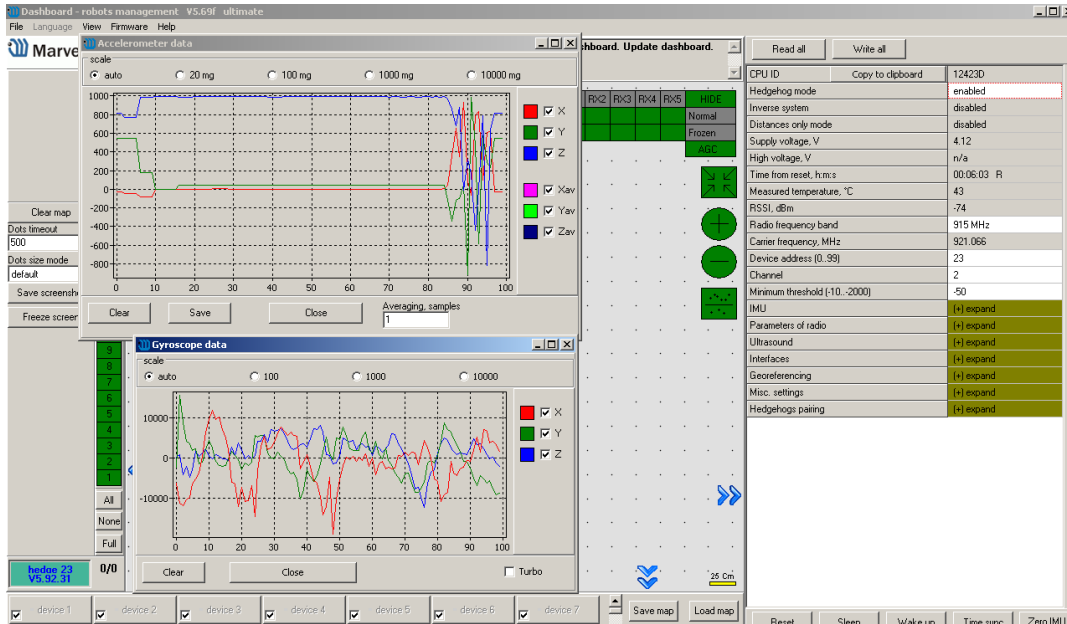

To calibrate an accelerometer on your beacon with IMU, you can do the following steps:

- Connect the mobile beacon via USB to the Dashboard
- Make sure that the beacon has IMU on board: open **View / Accelerometer menu** and **view / gyro data**. In the presence of IMU graphics in these windows should display the angular velocity and acceleration when moving the mobile beacon (turn it in hands).
Close the window of the accelerometer and gyro data
- Open the calibration window: **View / calibrate the accelerometer**

	X	Y	Z
Max	1010	1018	988
Min	-1019	-988	-1089
Delta	2029	2006	2077
Zero	-4	15	-50
K	0.986	0.997	0.963
15	1008	11	-63
14	1009	11	-75
13	1003	21	17
12	-16	-987	-25
11	-16	-988	-16
10	-15	-987	-32
9	-8	1013	-64
8	-11	1018	-63
7	5	45	985
6	0	41	986
5	0	42	988
4	-2	44	979
3	0	57	977
2	0	39	986

Buttons: Reset, Calibrate, Save, Load, Clear table, save line, pause, manual fill, auto fill, Number of averages: 20, Close

- When calibrating, it measures the data of the free fall (gravity of the Earth) corresponding to each of the three axes X, Y, Z. The initial ones from these calculations remember the correction shifts indicated in the table as "Zero" and the correction factors indicated as "K"
- The switch at the right bottom of the window should be in the **AutoFill** position
- Before starting the calibration, click the **Reset** button at the top of the window - zeroing the current calibration results

To calibrate: slowly, without jerking, manually turn the beacon in each of the 6 positions and keep it still for 1-2 seconds:

- The starting position - the beacon lies on the table; the antenna is pointing upwards (calibration Z +)
- The beacon is turned upside down, the antenna pointing down (calibration Z-)
- The beacon is on the end, the sensor RX1 is pointing towards the table (calibration Y +)
- The beacon rests on the end, the RX3 sensor points toward the table (calibration Y-)
- The beacon rests on the end, the RX2 sensor is directed towards the table (calibration X +). In order not to interfere with the USB connector, the beacon can be placed on the edge of the table, so that the cable hangs down
- The beacon rests on the end, the RX5 sensor points toward the table (calibration X-)
- In each measurement, the readings of the accelerometer are corrected by Zero and K.
At the end of the measurement of 6 points 7.1 ... 7.6, in the serviceable accelerometer Zero should be close to zero, and K close to 1, see the screenshot. If not - check if you forgot any of the points 7.1 ... 7.6.
- To save the results, click **Calibrate**.

11.12. Settings to obtain correct north direction

In some cases, it is necessary to obtain a correct north orientation of the map for NMEA output from Marvelmind system. For example, when using a Marvelmind mobile beacon as the navigation data source for Pixhawk installed on a copter, correct north is required for correct yaw control of the copter. The Marvelmind system cannot determine north automatically, so the user should make corrections after building and freezing the map. It can be done in one of two ways:

Option 1

- Rotate the Marvelmind map using the dashboard as shown on the screenshot below
- You can also view the video: <https://www.youtube.com/watch?v=AsYXrtg7aVU&feature=youtu.be>



The screenshot shows the Marvelmind dashboard with a map and a settings panel. The settings panel on the right has a red box around the 'Submap rotation, degrees' field, which is set to 0.00. Annotations on the map include:

- "A" - angle between real and Marvelmind north (indicated by a green arrow and a blue arrow).
- Real North, measured by any way (not by Marvelmind system) (indicated by a blue arrow).
- Marvelmind 'North' - always matches to Y axis (indicated by a red arrow).
- Enter the angle "A" in this field to align north directions. In this case the value should be negative to achieve clockwise rotation of the map. (indicated by a red arrow pointing to the Submap rotation field).

The settings panel on the right includes the following fields:

- Starting beacon trilateration (0.255) 0
- Starting set of beacons 10: 6:13:12
- Location update rate 16 Hz
- Maximum speed, m/s (0.1..60.0) 5.0
- Window of averaging (0.16) 4
- Movement filtering disabled
- High resolution mode (mm) enabled
- Supply voltage, V 4.95
- Time from reset, h:m:s 00:16:26 F
- Temperature of air, °C (-20..60) 23
- RSSI, dBm -49
- Carrier frequency, MHz 920.033
- Device address (0..99) 1
- Channel 1
- Parameters of radio (+) expand
- Interfaces (+) expand
- Georeferencing (+) expand
- Limitation distances auto
- Map gluing disabled
- Gluing ready no
- Submap X shift, m (-100.00..100.00) 0.00
- Submap Y shift, m (-100.00..100.00) 0.00
- Submap rotation, degrees (-360.00..360.00) 0.00

Option 2

- Enter the angle correction (the angle shown on screenshot) on the Pixhawk side from the Mission Planner of APM Planner
- Refer to the parameter "BCN_ORIENT_YAW":



http://ardupilot.org/copter/docs/parameters.html?highlight=bcn_orient_yaw

11.13. Communication of Pixhawk with Marvelmind mobile beacon

The Marvelmind mobile beacon can be connected to Pixhawk (and to any other hardware or software that inputs GPS according to the NMEA0183 protocol). The mobile beacon can send GPS data via UART and USB (virtual UART) interfaces. For further explanation, please check out this [document](#).



11.14. Sending path to robot

You can send the path for your robot via Dashboard

- The dashboard sends request to modem via USB.
- Procedure of sending these requests in dashboard is shown on second screenshot.
- This format of request is described in section 8 of modem protocol:
 - Modem transmits data to the hedgehog via radio, using our proprietary protocol https://marvelmind.com/pics/modem_usb_protocol_2017_01_27.pdf

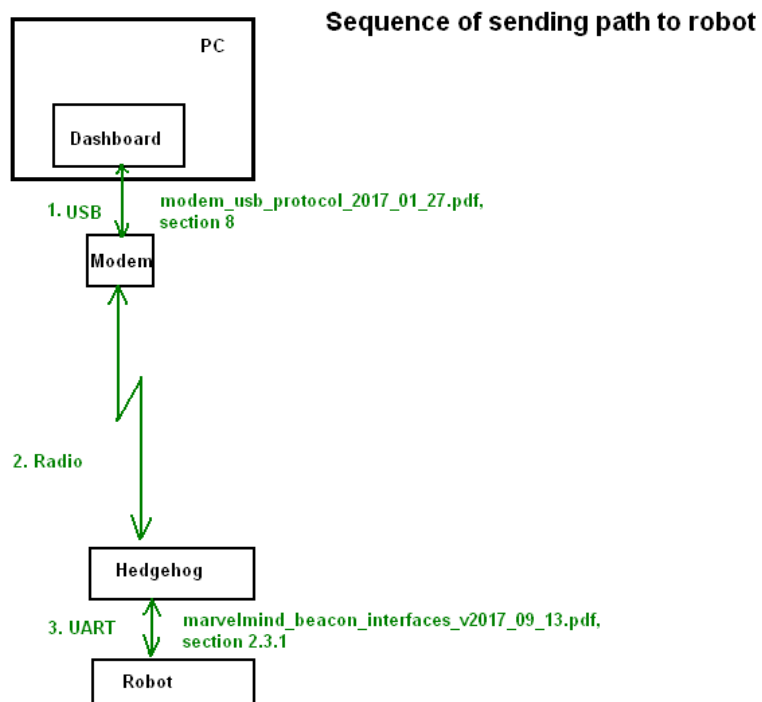



- the hedgehog communicates with robot via UART. Hedgehog sends data according to section 2.3.1 of this protocol:
- https://marvelmind.com/pics/marvelmind_beacon_interfaces.pdf
- The robot should confirm receiving data by response packet shown in section 2.3
- This communication on the robot side is implemented in the Arduino example on our site. As you can see in the protocol, robot should not request the waypoints, the hedgehog will send the waypoints when they will be transmitted from dashboard. But robot should confirm receiving each waypoint by this packet:
- [0x03,0x47,0x01,0x02,0x00, <2 bytes of checksum>]

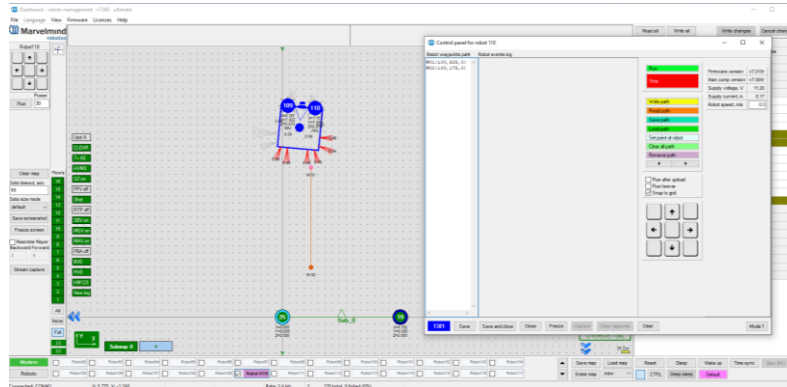

Learn more about Robot Boxie in [Marvelmind Boxie Operating Manual](#)

How to send a path:

- 1) Set up the Marvelmind Indoor “GPS” system.
- 2) Turn on Boxie and wait for 1 minute

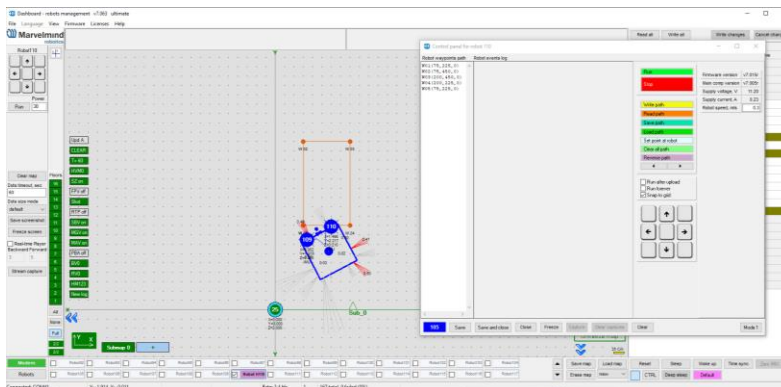

- 3) Configure paths and points (Use **Shift+Left mouse button click** to create point, click on point – to remove):

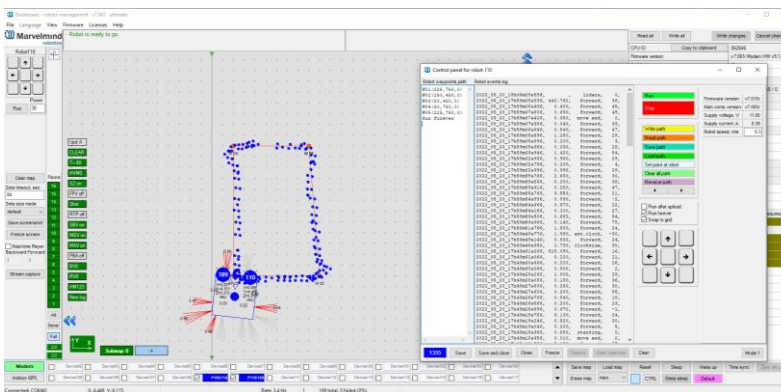

- 4) Press “Run”. Robot will follow the path that you draw:

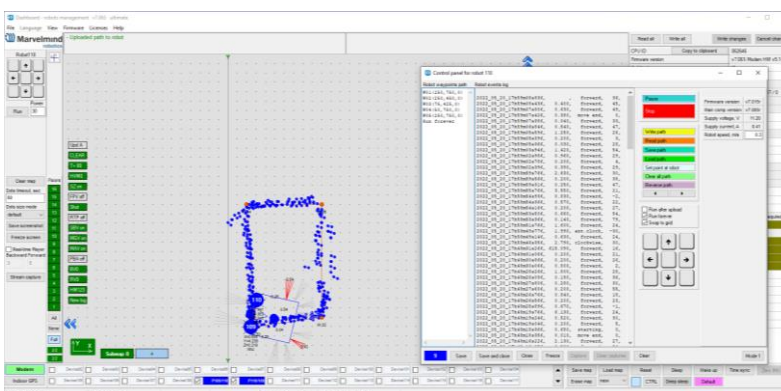

- 5) If you put a tick on “Run forever”. Robot will move till you press stop button in control panel or before obstacle detected:

11.15. Proper ultrasonic coverage



The single most important requirement for the system to work well is to have proper ultrasonic coverage

Each sensor has an ultrasonic beam of ~90 degrees. Outside of that range, the emitting power and sensitivity drops quite rapidly. From the left, right, or back of the ultrasonic sensor, the signal is highly attenuated. Thus, it is crucial to provide proper ultrasonic coverage for the area where the robot will be moving.

- It is also very important to provide proper ultrasonic coverage to the stationary beacons when the map is being formed
- **Mobile beacon (“hedgehog” or “hedge”) is designed to be placed horizontally**
- The mobile beacon has four horizontal and one vertical sensor, each covering its own sector. Together, they cover 360 degrees horizontally and 180 degrees in the upper hemisphere. The lower hemisphere is highly attenuated, so don't expect ultrasonic coverage in that area
- It is advised that the mobile beacon be placed as high as possible on the robot if the stationary beacons are above the mobile beacon. This minimizes shadows from other objects, people, etc.

The screenshot displays the Marvelmind robots management interface. On the left, there is a table with columns labeled 'HIDE', '22', '23', '24', '25', and '26'. The table contains numerical data for each column. Below the table are buttons for 'clear map', 'Dots timeout: 300', 'save screenshot', and 'freeze screen'. The main area is a 2D map with a grid. Several beacons are placed on the map, labeled with IDs like 22, 23, 24, 25, 26, 27, 28, 29, 30, 31, 32, 33, 34, and 35. A 'hedgehog' beacon is also present. A configuration panel on the right shows various settings for the hedgehog mode, including supply voltage, height, time from reset, measured temperature, RSSI, carrier frequency, device address, channel, minimum threshold, and radio parameters. The 'unfreeze map' button is visible on the map.

HIDE	22	23	24	25	26
		10.262	10.398	6.618	
	10.262		9.993	4.853	
	10.398	9.993		11.345	
	6.618	4.853	11.345		
	6.991	3.639	9.947	2.003	



- Example of proper positioning of the mobile beacon can be found here: <https://youtu.be/PFgNPkLGCDk>
- The beacon is placed horizontally and above other objects that can cast a shadow on the stationary beacons
- **Keep the radio signal's strength under control**
- The RSSI (Dashboard => right menu) of any beacon/modem must not be higher than -25dBm. Otherwise, the system may malfunction
- It is recommended the distance between the modem and beacons be no less than 0.5–1m. Beacons can be placed as close to each other as needed. If a beacon is extremely close to the modem, disconnect the antenna from the beacon. Monitor the Received Signal Strength Indicator (RSSI). It must be in the range of -25 to -70dBm. An RSSI of less than -70dBm will work too, but packet losses may start occurring. The quality of the radio connection very much depends on external interference as well because the used band is ISM (either 915MHz or 433MHz) and there are numerous co-existing systems.
- Use 30 - 50 periods (pulses) in settings instead of the default 5. Select:
- **Ultrasound settings => Number of periods**

Ultrasound	{-} collapse
Mode of work	TX+RX normal
Analog power in sleep	enabled
Power after transmission	not tum off
Frequency, Hz (100..65000)	31000
Duty, % (1..99)	50
Number of periods (1..100)	5
Amplifier limitation (calibrated)	4000
Amplification	AGC
AGC desired level (-1800..0)	-500
AGC hysteresis (10..2000)	130
AGC step, dB (1..20)	3
Mode of threshold	automatic
Minimum threshold (-10..-2000)	-50

- When you have large errors in position estimation (more than a 1m inaccuracy), use the embedded Oscilloscope on **Dashboard => View** to determine which stationary beacon is jammed
- Reduce the gain of the ultrasonic manually depending on your system

11.16. Sensors settings: example for 2D and mobile beacon

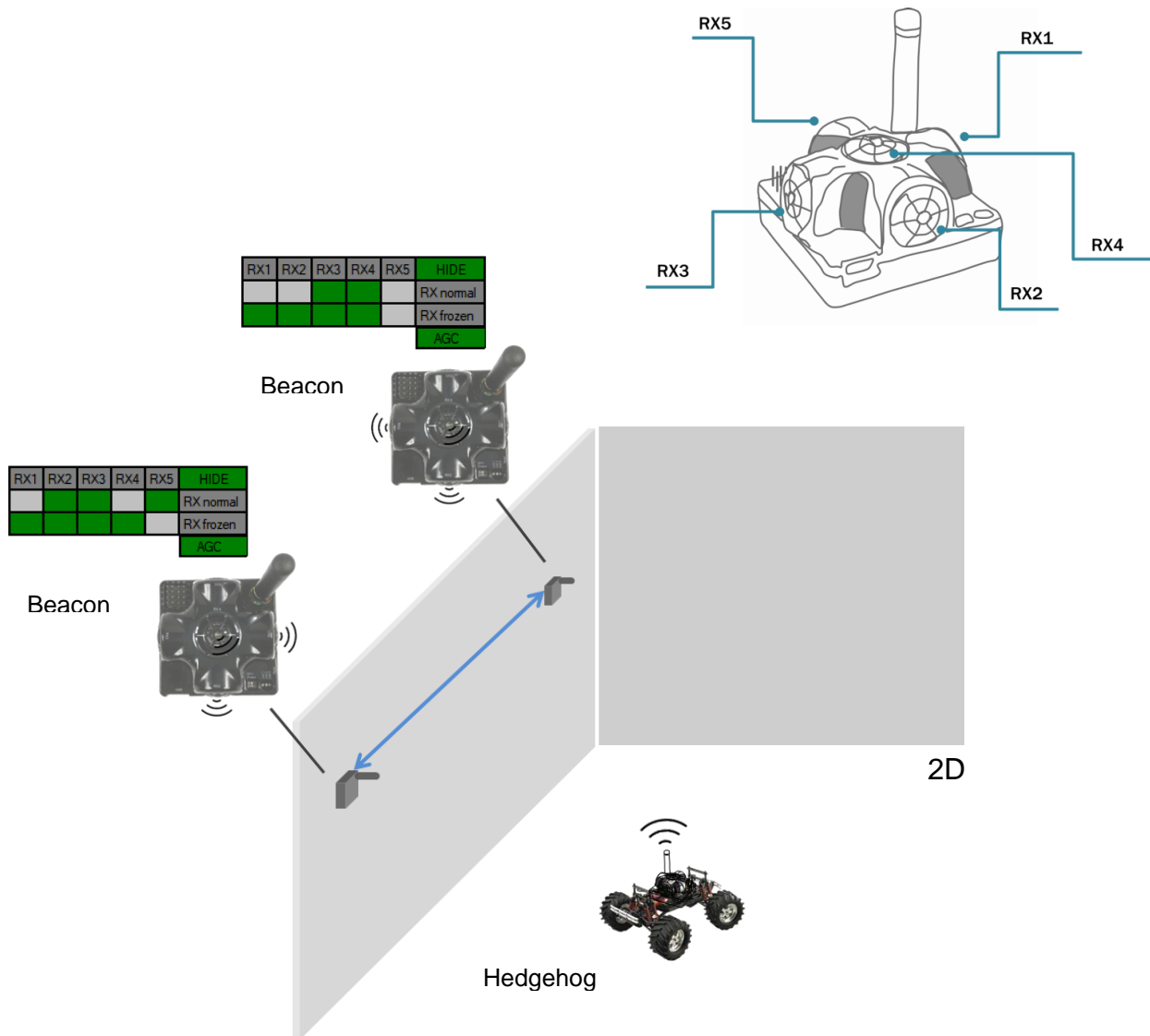

Beacon 2

RX1 and RX4 emit ultrasound in normal mode for better ultrasonic signal exchange with Beacon 3. In frozen mode RX2 added as working sensor. The rest sensors are turned off

Changing sensors' settings could be found in the panel in the upper right corner of the Dashboard during your beacon is connected to the computer

Beacon 3

RX3 and RX4 emit ultrasound in normal mode for better ultrasonic signal exchange with Beacon 2. In frozen mode RX2 added as working sensor. The rest sensors are turned off

11.17. Powering beacons



Depending on the type of beacon, may be internal battery, or external USB power supply, for more details check [comparison table](#)

Battery lifetime totally depends on the mode of operation and can be varied between several days to several months (or more for special applications)

Learn more here: [Power supply options for beacons](#)

11.18. Power supply and Leds

- Modem doesn't have battery, so power supply led is always on, when Modem connect to computer.
- Power supply led for battery (for Super-Beacons, Beacons HW v.4.9 and Mini-RX Beacons) is on, when battery is charging and is off when battery isn't charging. Battery stops charging when fully charged, when this happens, led goes out. So, led turns off and on periodically, what means that beacon fully charged and led turns on again when battery drops a few millivolts.
- You can always find out the battery level by connecting it to Dashboard via USB or radio.

Hedgehog mode	disabled
Supply voltage, V (3.5..4.2)	3.82
Time from reset, h:m:s	00:00:53 / 18.31.09 / 0

Status of charge:

- 4.1V - 4.2V – absolutely fully charged
- 3.6V – 4V – good charged
- 3.2V – 3.6V – very low charge
- 3.2V – fully discharged

Learn more here: [Power supply options for beacons](#)

12. Frequently Asked Questions

 Please check this [forum](#) for more information. Here we will answer the most common questions

1 What is the proper way to place the beacons?

- The actual distance between beacons must be $\leq 30\text{m}$. Provide the line of sight from one beacon to minimum two others

2 How far can beacons be located from modem?

- In the open space the distance from the modem to the beacon can reach several hundred meters

3 What if hedgehog shown as **orange** circle or **transparent** inside in the Dashboard?

- **Blue** - normal mode and confident tracking
- **Orange** - system provides the best location data possible, but confidence is lower, than blue
- - lost radio packets or no ultrasound coverage

4 What is the obstacle for ultrasound?

- The real obstacles for ultrasound are walls (concrete), glass, metal. If you need to cover a multiple-floor territory you can use our Submap feature in which case the tracking will not be interrupted

5 How the system works in very low and very high temperatures?

- System is designed for normal office-like conditions and temperatures $0\text{ }^{\circ}\text{C}$ - $40\text{ }^{\circ}\text{C}$
- You can see some other types of beacon (outdoor, explosion safe, etc.) in the [comparison table](#)
- We also possible to produce some special versions, which will suit your case. Please write to info@marvelmind.com

6 Are beacons resistant to explosions, dust, dirt, water, noise?

- - Low-frequency noise (motor noise, industrial equipment) does not interfere with the normal operation of the system
- You can see some other types of beacon (outdoor, explosion safe, etc.) in the [comparison table](#)

7 What is the time of delay between positioning the object and respond?

- The delay is directly proportional to the update rate. For example, if update rate is 16 Hz delay is $1.2:1.5 \times 60\text{ms}$
- The limit is 1.5x times the maximum distance between the stationary beacons. To expand the service area, please follow the instructions shown in the attached screenshot. Notice that positioning the mobile

beacon far from stationary beacons and close to their plane may result in increased positioning error because of bad geometry of measurement

8 How to define IMU or not IMU beacon?

- Check white sticker on the box and on the beacon's bottom /IMU - with IMU
- Connect beacon via USB: Dashboard => View => Accelerometer data

9 Can we use none-IMU beacon as mobile beacon or not?

- Yes, you can (<https://www.youtube.com/watch?v=A4aRsjH2-E>)

10 What is the reason to choose 915Mhz vs 433Mhz?

- The 915MHz version is designed for the US, Canada and Americas in general. The ISM band (license-free band for industrial, science and medical applications) in those countries is 915MHz
- In Europe, it is 433MHz

11 Device do not connect via USB?

- Use USB cable with long metal part. If you have any problems with USB connection, change the cable first. One cable can work for one device and do not work for other

12 Does the orientation of the beacon matter?

- Yes, it is. Place and orientate it in positions, where sensors can "hear" each other. v4.9 beacon has $\approx 90^\circ$ per sensor coverage([illustration](#)), Mini-RX and Industrial-RX have $\approx 180^\circ$ coverage([illustration](#))

13 Why Dashboard do not see more than 4 beacons

- System has a limitation of 4 beacons per submap. If you have more than 4 beacons, just create another submap, and beacons will appear

13. Troubleshooting checklist

If you have any problems with the system, follow these simple steps:

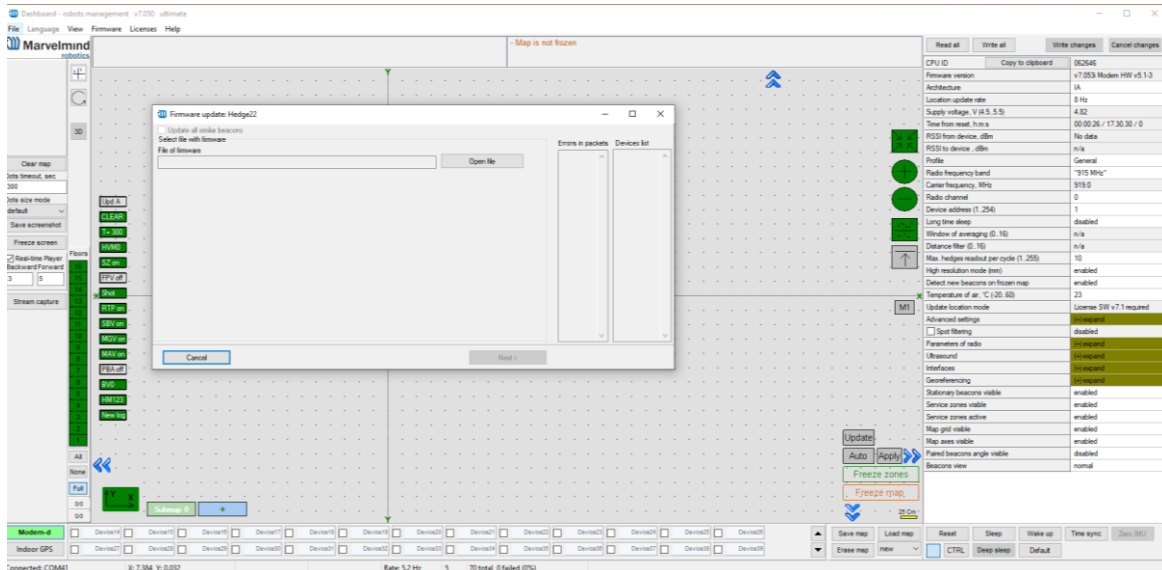

- **Update SW** on modem and beacons
- Now, connect all beacons and modem one by one and press **Default** button in the Dashboard (When updating the SW, please, press **Default** button to make sure that beacons really have default settings. Otherwise, modem may be calling on a wrong channel or something)
- Press **Erase map**, when modem connected to PC

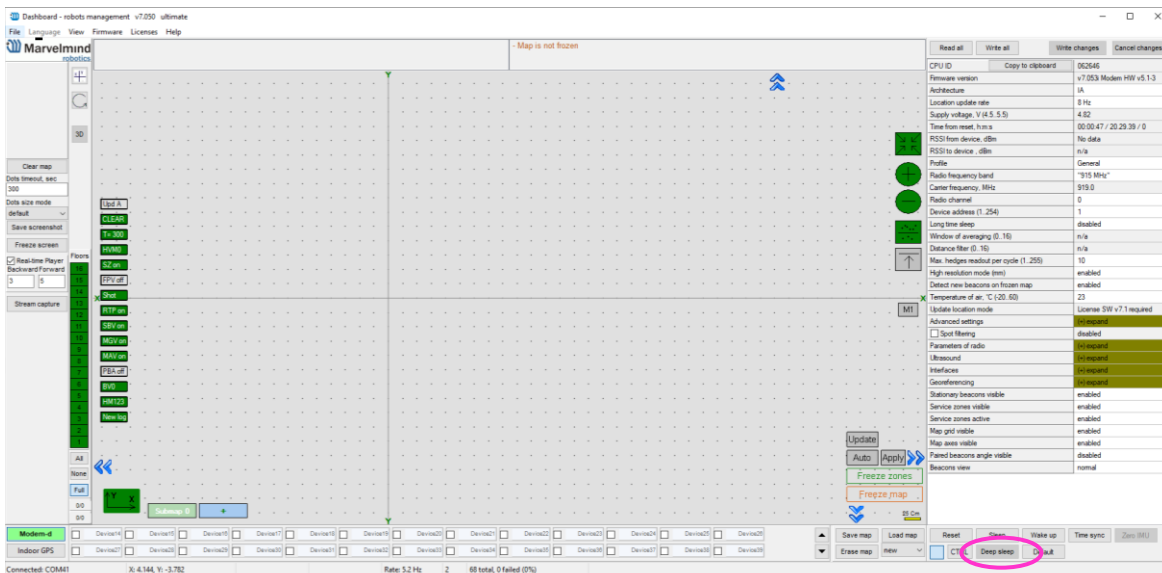

13.1. Checklist before starting the system:



IA and NIA SW differs

For IA you should use stationary beacons with different frequencies

Make sure that you use correct SW. Inverse Architecture(IA) SW for Inverse system, Non-Inverse Architecture(NIA) SW for Non-Inverse system ([Architectures comparison](#))

Make sure that your beacons are 3.5V and higher before using. If not, charge it for 2-3 hours.

- Keep modem 1-2m away from beacons. if closer, the beacons radio may be overloaded
- Antenna's recommendations:
 - The antenna must be kept as straight as possible. Otherwise it will reduce the effective range
 - The antennas must be kept away from conductive materials, such as metal and carbon by at least a half inch
 - Keep the antennas away from the motors and other noise sources as much as possible
- Use USB cable with long metal part. If you have any problems with USB connection, change the cable first. One cable can work for one beacon and do not work for other
- Be sure that you use SW from the same pack
- When updating the SW, please, press Default button to make sure that beacons really have default settings. Otherwise, modem may be calling on a wrong channel or something
- Start with simple configuration (10x10m square, 4 stationary beacons)
- Do not obstruct line of sight between beacons
- Build the map first, freeze it, then wake up the "hedge"
- Number of periods. By default – 5 for HW v4.9. 20 for Super-Beacon, 50 for Mini-TX. For longer distances you can put 10-50



Mini-RX beacon may be over discharged. In that case do the following:

- Turn off the beacon with DIP switches
- Charge it for 1 hour
- Turn the beacon on, flash the latest SW via DFU Programming and charge it for 1 hour again

14. Contacts

For more information about company check: [About us](#)

For additional support, please send your questions to info@marvelmind.com