

4 CKT SHOWN

NOTES:

1) MATERIAL:

- 225S = NYLON 6, UL94V-2, GLOW WIRE MATERIAL COLOR: BLACK
- 225NS = NYLON 6, UL94V-2, GLOW WIRE MATERIAL COLOR: NATURAL
- 250RS = NYLON 6/6, UL94V-0, GLOW WIRE MATERIAL COLOR: RED
- 250GS = NYLON 6/6, UL94V-0, GLOW WIRE MATERIAL COLOR: GREEN
- 250BS = NYLON 6/6, UL94V-0, GLOW WIRE MATERIAL COLOR: BLUE
- 250WS = NYLON 6/6, UL94V-0, GLOW WIRE MATERIAL COLOR: NATURAL

2) FINISH: NOT APPLICABLE

3) PRODUCT SPECIFICATION: PS-5556-001

4) PACKAGING: BULK

5) PART MATES WITH MOLEX PLUG #46993 AND HEADERS #172447, #172448.

6) PART TO BE USED WITH MOLEX FEMALE TERMINAL #5556.

7) PART IS NOT DESIGNED FOR CURRENT SHARING.

8) CONNECTORS ARE NOT TO BE MATED OR UNMATED WHILE CIRCUITS ARE LIVE.

9) WIRES ARE TO BE DRESSED IN SUCH A MANNER TO ALLOW THE TERMINALS TO FLOAT FREELY IN THE POCKET.

10) PART CONFORMS TO CLASS "B" REQUIREMENTS OF COSMETIC SPECIFICATION PS-45499-002 WITH THE EXCEPTION OF DISCOLORATION, FLASH AND SINK MEET

△ CLASS "C" REQUIREMENTS.
TO BE MEASURED AT SURFACE [Z]

12) TEXT ON PART IS FOR REFERENCE ONLY. TEXT AND TEXT LOCATION MAY VARY DEPENDING ON PART NUMBER AND/OR TOOL.

13) APPLICATION SPECIFICATION :469920000-AS.

14) BUBBLE IS ACCEPTABLE ON LATCH AREA.

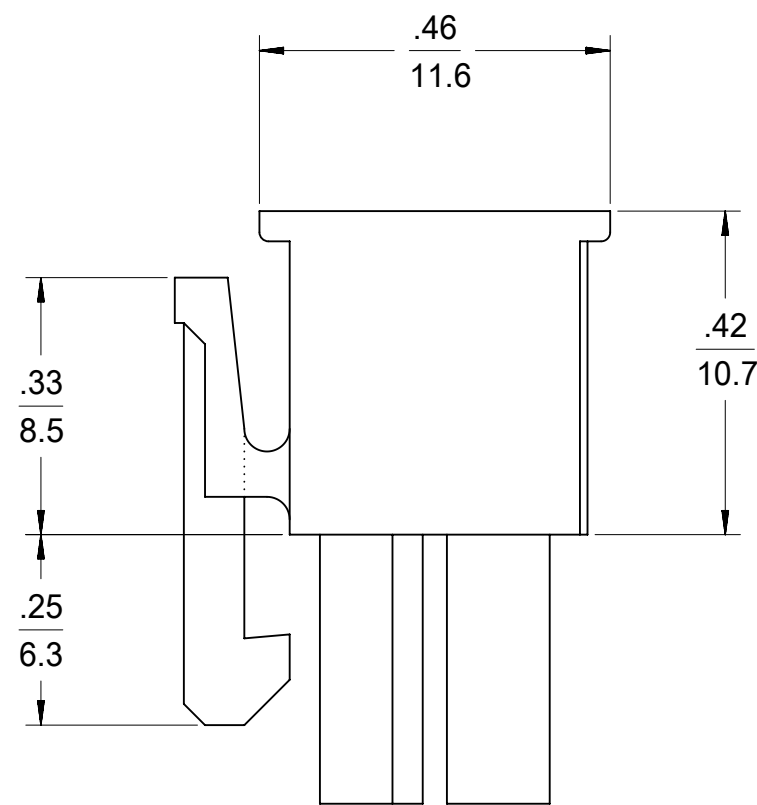
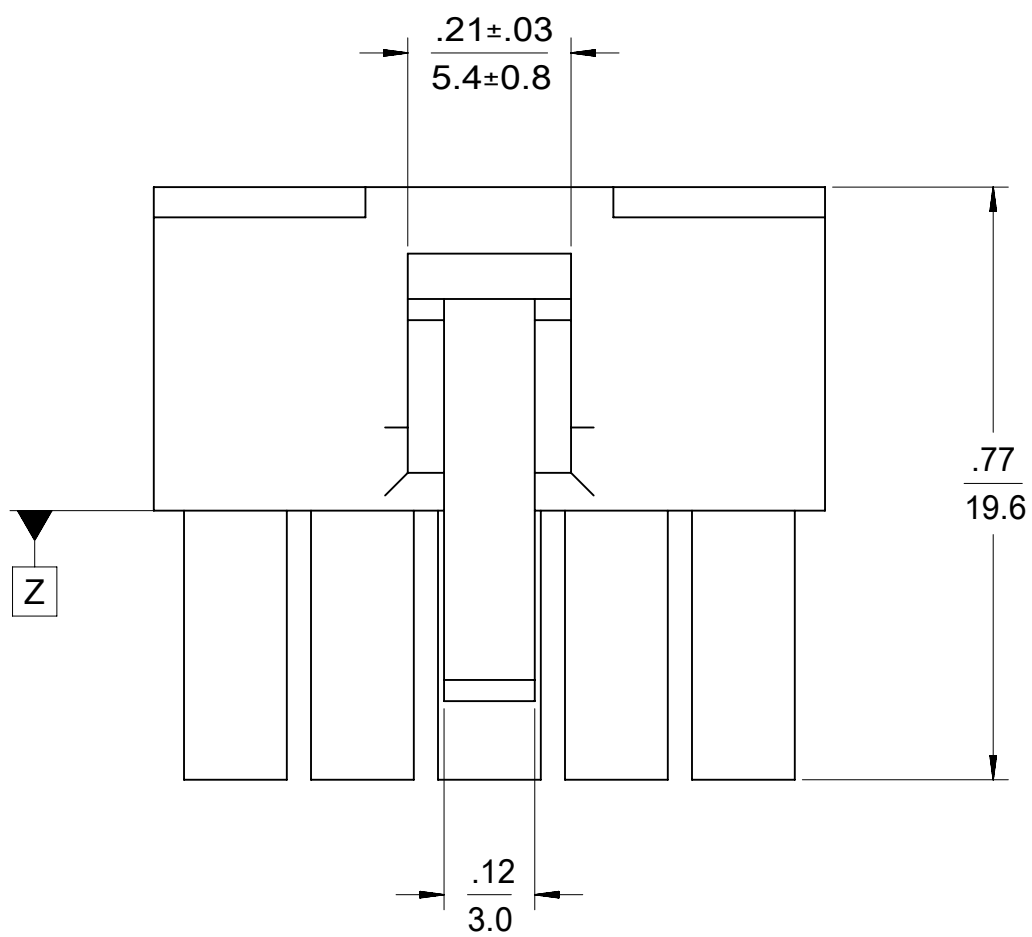

4-24 CKT

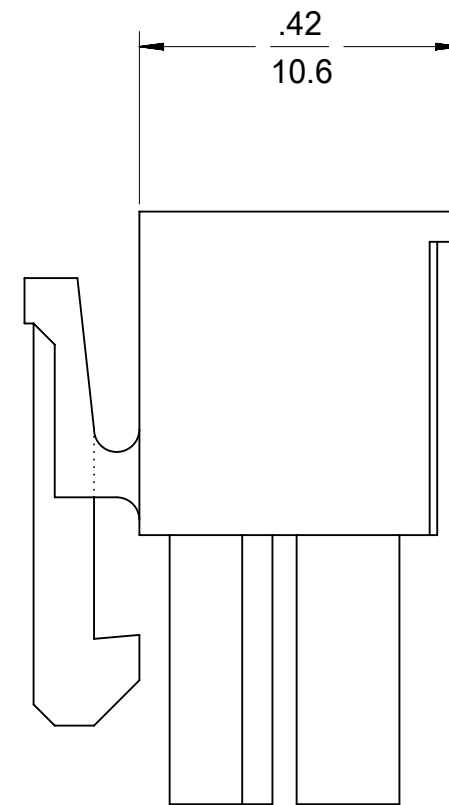

2 CKT ONLY

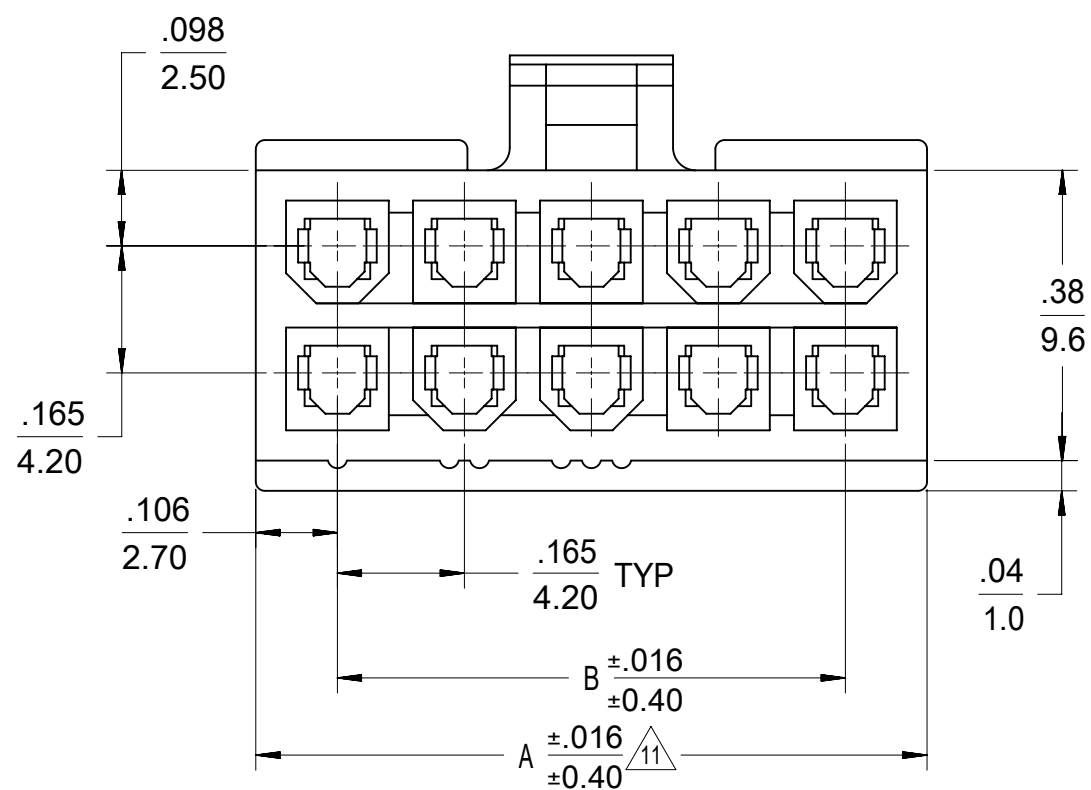

LEGEND

- 46992 -*** 0
- CIRCUIT SIZE
- MATERIAL (SEE NOTE 1)
- 0 = 225NS
- 1 = 225S
- 2 = 250RS
- 3 = 250GS
- 4 = 250BS
- 5 = 250WS
- CONFIGURATION
- DUAL ROW

| | | | | | | | | | |
|---|--|----------------|--|------------------------|--|------------|--|---------------------------------------|--|
| THIS DRAWING CONTAINS INFORMATION THAT IS PROPRIETARY TO MOLEX ELECTRONIC TECHNOLOGIES, LLC AND SHOULD NOT BE USED WITHOUT WRITTEN PERMISSION | | | | | | | | | |
| DIMENSION UNITS | | SCALE | | CURRENT REV DESC: | | | | | |
| mm | | NTS | | EC NO: 719028 | | | | | |
| GENERAL TOLERANCES (UNLESS SPECIFIED) | | | | DRWN: JERRYW8 | | 2022/08/23 | | MINIFIT JR | |
| 4 PLACES | | ± | | CHK'D: XQZHANG | | 2022/09/01 | | RECEPTACLE HOUSING DUAL ROW, 2-24 CKT | |
| 3 PLACES | | ± | | APPR: XQZHANG | | 2022/09/01 | | PRODUCT CUSTOMER DRAWING | |
| 2 PLACES | | ± 0.25 ± 0.015 | | INITIAL REVISION: | | | | DOCUMENT NUMBER | |
| 1 PLACE | | ± 0.38 ± | | DRWN: NNGUYEN | | 2013/04/12 | | SD-46992-0000 | |
| 0 PLACES | | ± | | APPR: FSMITH | | 2014/05/16 | | PSD 000 A9 | |
| ANGULAR TOL ± 3.0 ° | | | | THIRD ANGLE PROJECTION | | DRAWING | | SHEET NUMBER | |
| DRAFT WHERE APPLICABLE MUST REMAIN WITHIN DIMENSIONS | | | | C-SIZE | | SERIES | | MATERIAL NUMBER | |
| | | | | | | 46992 | | CUSTOMER | |
| | | | | | | | | GENERAL MARKET | |
| | | | | | | | | 1 OF 2 | |

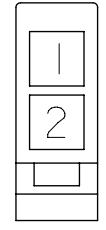

2 CKT.

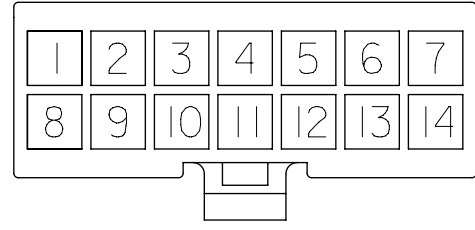

14 CKT.

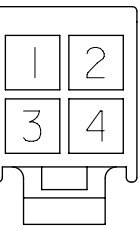

4 CKT.

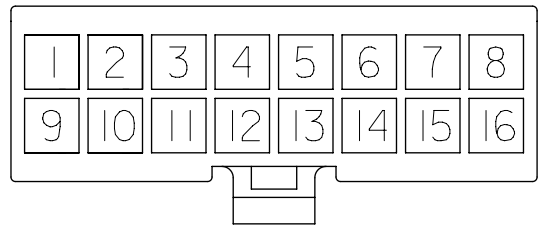

16 CKT.

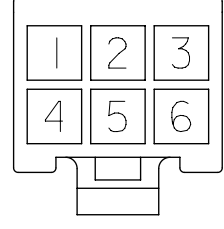

6 CKT.

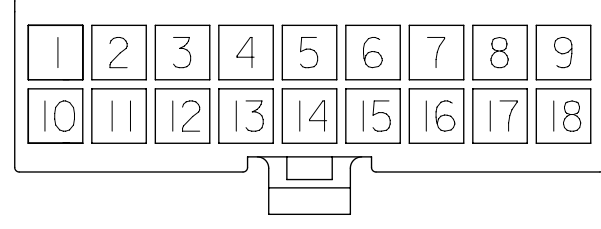

18 CKT.

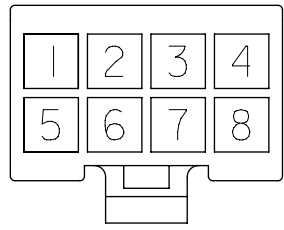

8 CKT.

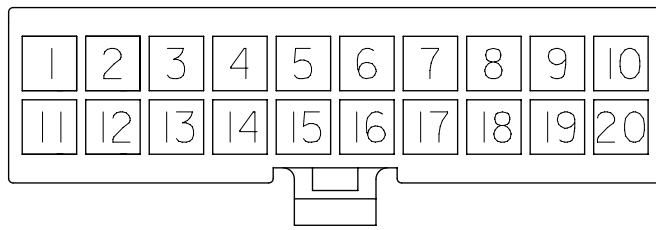

20 CKT.

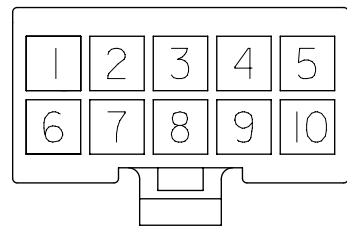

10 CKT.

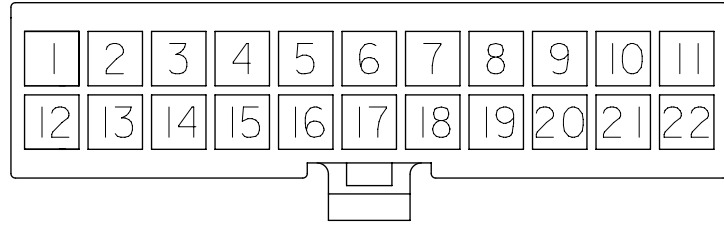

22 CKT.

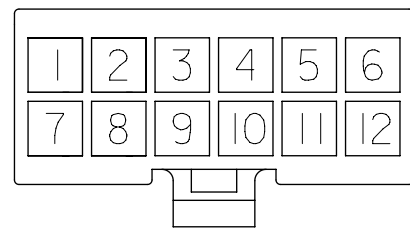

12 CKT.

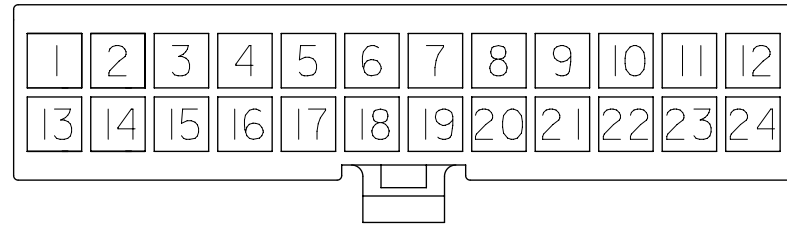

24 CKT.

**CIRCUIT SIZE LAYOUT
(NOT TO SCALE)**

| PART NUMBER | CKT SIZE | DIM "A" | DIM "B" | MATERIAL CODE & COLOR |
|-------------|----------|-----------|------------|-----------------------|
| 46992-0240 | 02 | .21/5.40 | -- | 250BS BLUE (V0) |
| 46992-0440 | 04 | .38/9.60 | .165/4.20 | |
| 46992-0640 | 06 | .54/13.8 | .331/8.40 | |
| 46992-0840 | 08 | .71/18.0 | .496/12.60 | |
| 46992-1040 | 10 | .87/22.2 | .661/16.8 | |
| 46992-1240 | 12 | 1.04/26.4 | .827/21.00 | |
| 46992-0250 | 02 | .21/5.40 | -- | 250WS NATURAL (V0) |
| 46992-0450 | 04 | .38/9.60 | .165/4.20 | |
| 46992-0650 | 06 | .54/13.8 | .331/8.40 | |
| 46992-0850 | 08 | .71/18.0 | .496/12.60 | |
| 46992-1050 | 10 | .87/22.2 | .661/16.8 | |
| 46992-1250 | 12 | 1.04/26.4 | .827/21.00 | |

| PART NUMBER | CKT SIZE | DIM "A" | DIM "B" | MATERIAL CODE & COLOR |
|-------------|----------|-------------|-------------|-----------------------|
| 46992-0200 | 02 | .21/5.40 | -- | 225NS NATURAL (V2) |
| 46992-0400 | 04 | .38/9.60 | .165/4.20 | |
| 46992-0600 | 06 | .54/13.8 | .331/8.40 | |
| 46992-0800 | 08 | .71/18.0 | .496/12.60 | |
| 46992-1000 | 10 | .87/22.2 | .661/16.8 | |
| 46992-1200 | 12 | 1.04/26.4 | .827/21.00 | |
| 46992-1400 | 14 | 1.21 / 30.6 | .992/25.20 | |
| 46992-1600 | 16 | 1.37 / 34.8 | 1.158/29.40 | |
| 46992-1800 | 18 | 1.54 / 39.0 | 1.323/33.60 | |
| 46992-2000 | X 20 | 1.70 / 43.2 | 1.488/37.80 | |
| 46992-2200 | X 22 | 1.87 / 47.4 | 1.654/42.00 | |
| 46992-2400 | X 24 | 2.03 / 51.6 | 1.819/46.20 | |

| | | | | |
|------------|------|-------------|-------------|--------------------|
| 46992-0210 | 02 | .21/5.40 | -- | 225S BLACK (V2) |
| 46992-0410 | 04 | .38/9.60 | .165/4.20 | |
| 46992-0610 | 06 | .54/13.8 | .331/8.40 | |
| 46992-0810 | 08 | .71/18.0 | .496/12.60 | |
| 46992-1010 | 10 | .87/22.2 | .661/16.8 | |
| 46992-1210 | 12 | 1.04/26.4 | .827/21.00 | |
| 46992-1410 | 14 | 1.21 / 30.6 | .992/25.20 | |
| 46992-1610 | 16 | 1.37 / 34.8 | 1.158/29.40 | |
| 46992-1810 | 18 | 1.54 / 39.0 | 1.323/33.60 | |
| 46992-2010 | X 20 | 1.70 / 43.2 | 1.488/37.80 | |
| 46992-2210 | X 22 | 1.87 / 47.4 | 1.654/42.00 | |
| 46992-2410 | 24 | 2.03 / 51.6 | 1.819/46.20 | |

| | | | | |
|------------|----|-----------|------------|-------------------|
| 46992-0220 | 02 | .21/5.40 | -- | 250RS RED (V0) |
| 46992-0420 | 04 | .38/9.60 | .165/4.20 | |
| 46992-0620 | 06 | .54/13.8 | .331/8.40 | |
| 46992-0820 | 08 | .71/18.0 | .496/12.60 | |
| 46992-1020 | 10 | .87/22.2 | .661/16.8 | |
| 46992-1220 | 12 | 1.04/26.4 | .827/21.00 | |

| | | | | |
|------------|----|-----------|------------|---------------------|
| 46992-0230 | 02 | .21/5.40 | -- | 250GS GREEN (V0) |
| 46992-0430 | 04 | .38/9.60 | .165/4.20 | |
| 46992-0630 | 06 | .54/13.8 | .331/8.40 | |
| 46992-0830 | 08 | .71/18.0 | .496/12.60 | |
| 46992-1030 | 10 | .87/22.2 | .661/16.8 | |
| 46992-1230 | 12 | 1.04/26.4 | .827/21.00 | |

X = NOT TOOLED

THIS DRAWING CONTAINS INFORMATION THAT IS PROPRIETARY TO MOLEX ELECTRONIC TECHNOLOGIES, LLC AND SHOULD NOT BE USED WITHOUT WRITTEN PERMISSION

| | | | | | | | | | |
|--|---|------------------------|---------|--------------------|--|--|--|--|--|
| DIMENSION UNITS | | SCALE | | CURRENT REV. DESC. | | | | | |
| mm | | NTS | | | | | | | |
| GENERAL TOLERANCES (UNLESS SPECIFIED) | | | | | | MINIFIT JR RECEPTACLE HOUSING DUAL ROW, 2-24 CKT PRODUCT CUSTOMER DRAWING DOCUMENT NUMBER: SD-46992-0000 DOC TYPE: PSD DOC PART: 000 REVISION: A9 MATERIAL NUMBER: SEE TABLE CUSTOMER: GENERAL MARKET SHEET NUMBER: 2 OF 2 | | | |
| | | MM | INCH | | | | | | |
| 4 PLACES | ± | | ± | | | | | | |
| 3 PLACES | ± | | ± 0.01 | | | | | | |
| 2 PLACES | ± | 0.25 | ± 0.015 | | | | | | |
| 1 PLACE | ± | 0.38 | ± | | | | | | |
| 0 PLACES | ± | | ± | | | | | | |
| ANGULAR TOL | | ± 3.0 ° | | | | | | | |
| DRAFT WHERE APPLICABLE MUST REMAIN WITHIN DIMENSIONS | | THIRD ANGLE PROJECTION | | DRAWING SERIES | | | | | |
| | | | | C-SIZE 46992 | | | | | |

EC NO: 719028
 DRWN: JERRYW8 2022/08/23
 CHK'D: XQZHANG 2022/09/01
 APPR: XQZHANG 2022/09/01
 INITIAL REVISION:
 DRWN: NNGUYEN 2013/04/12
 APPR: FSMITH 2014/05/16