

Apollo3 Decoupling

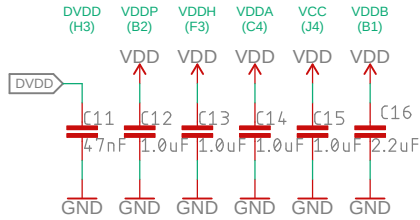

Amiq Apollo3

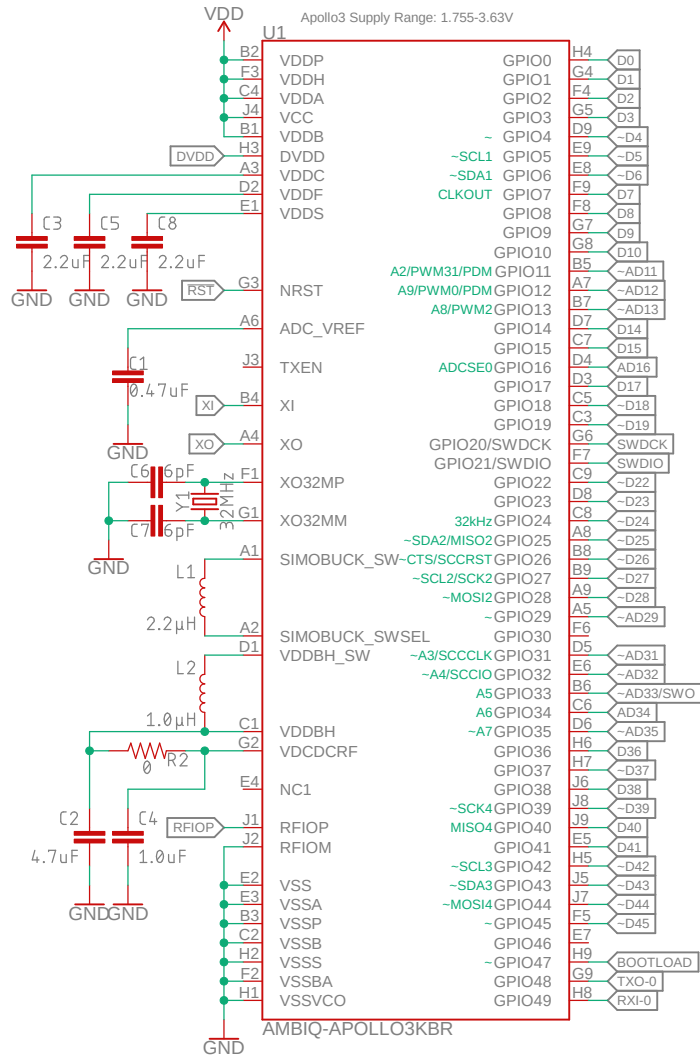

Primary

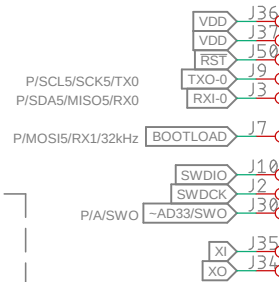

Secondary

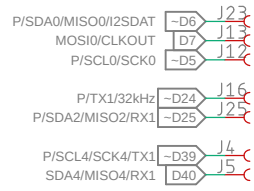

Tertiary

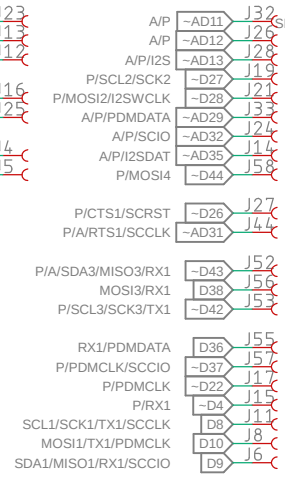

Quaternary

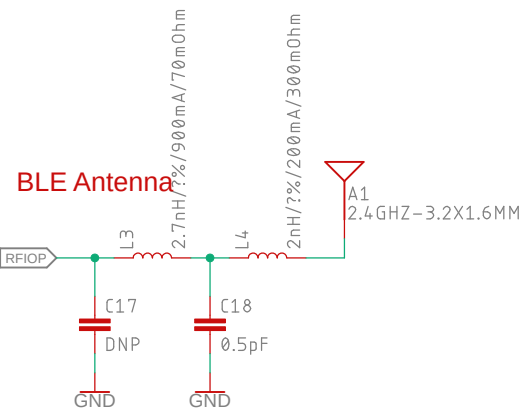
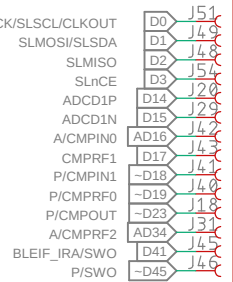

Microstrip Calculation:
 Board thickness: 0.8mm
 Er: 4.6
 RF Trace Width: 11.55mil/0.293mm
 Polygon Isolation: 5mil/0.127mm
 Distance between Layer 1/2: 0.2mm
<https://chemandy.com/calculators/coplanar-waveguide-with-ground-calculator.htm>

Released under the Creative Commons Attribution Share-Alike 4.0 License
<https://creativecommons.org/licenses/by-sa/4.0/>

TITLE: SparkFun_Artemis

Design by: N. Seidle

REV: v01

Date: 6/20/2019 9:36 AM

Sheet: 1/1