

Contact Information

**540-Wire Wrap, Regular Point - Tail LG.=.560(14.22)
 .125" (3.18mm) Contact Spacing x .250" (6.35mm) Row Spacing**

THIS IS A C.A.D. GENERATED DRAWING
 DO NOT MAKE MANUAL REVISIONS TO MASTER.



ISSUE NUMBER

ORIGINAL ①

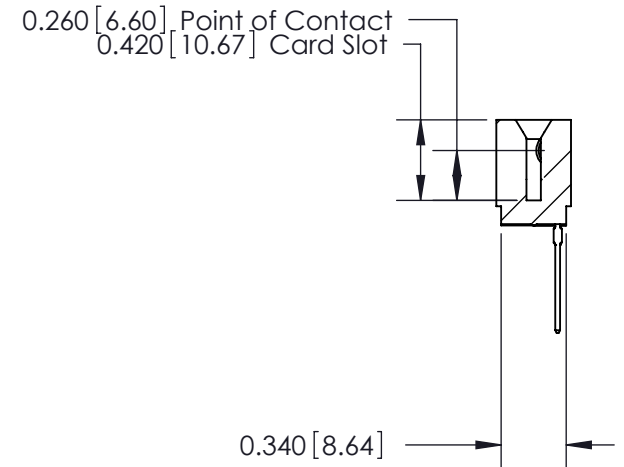
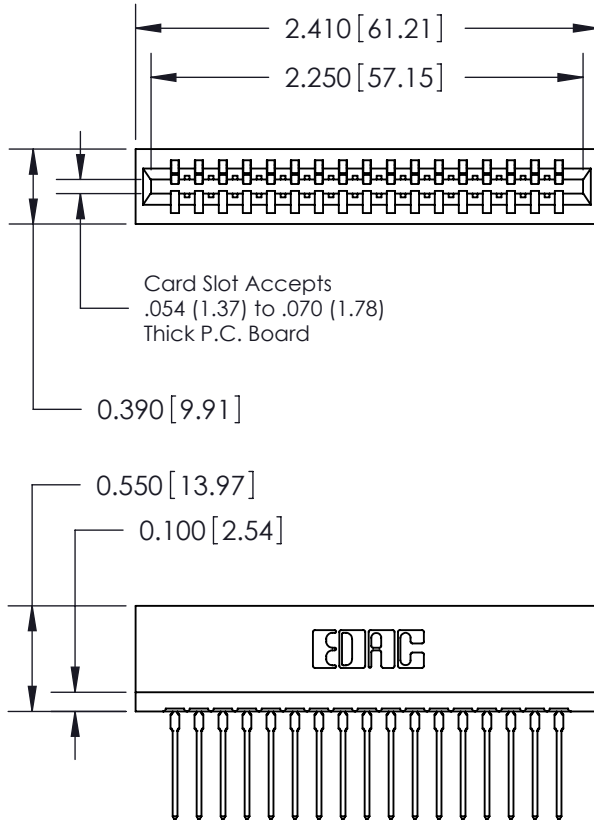

726 Series Ultra-Mate Card Edge Connector - Press Fit

Part Number: 726-017-540-101



EDAC INC
 TORONTO, ONTARIO
 CANADA

YOUR CONNECTION TO QUALITY & SERVICE

THESE DRAWINGS AND SPECIFICATIONS
 ARE THE PROPERTY OF EDAC INC. AND
 SHALL NOT BE REPRODUCED, OR COPIED
 OR USED AS THE BASIS FOR THE
 MANUFACTURE OR SALE OF APPARATUS
 WITHOUT WRITTEN PERMISSION.

ACAD REFERENCE NO. 726-ENG MASTER	
DRAWN: J.LEE	DATE: AUG 20/09
CHECKED:	DATE:
SCALE:	SHEET 1 OF 2
DRAWING NUMBER 726-ENG MASTER	ISSUE 1