

Data sheet | Item number: 2000-5310/102-000

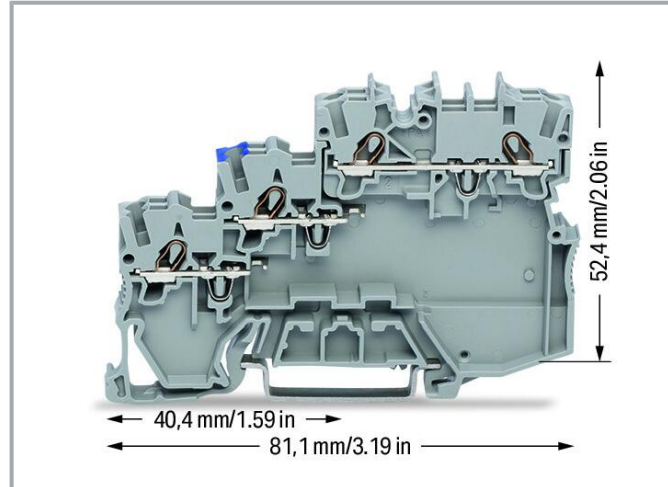

3-conductor actuator supply terminal block; for PNP-(high-side) switching actuators; with ground connection via push-in type jumper bars; with colored conductor entries; 1 mm²; Push-in CAGE CLAMP®; 1,00 mm²; gray

www.wago.com/2000-5310/102-000

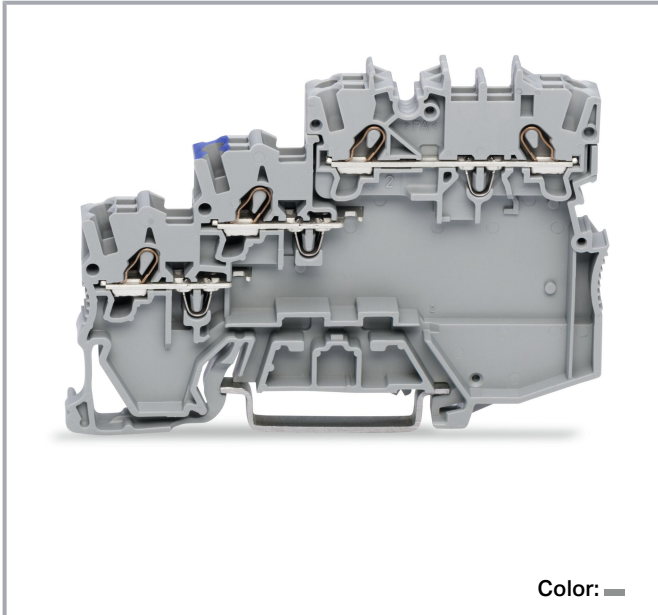

Color: —

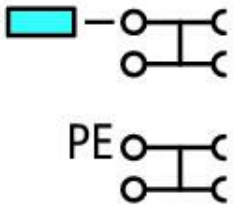
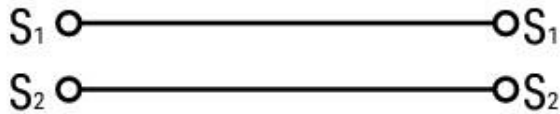

Item description

3.5 mm spacing per signal (2 x 3.5 mm = 7 mm)

Subject to changes. Please also observe the further product documentation!

WAGO GmbH & Co. KG
Hansastr. 27
32423 Minden
Phone: +49571 887-0 | Fax: +49571 887-169
Email: info.de@wago.com | Web: www.wago.com

Do you have any questions about our products?
We are always happy to take your call at +49 (571) 887-44222.



The double spacing per pole of this terminal block series maximizes connectivity. For example, ten sensors may be connected using only five sensor terminal blocks plus a power supply terminal block.

Data Notes

Safety information

Ground connection via commoning to terminal blocks with ground foot

Electrical data

Ratings per IEC/EN

Ratings per	IEC/EN 60947-7-1
Nominal voltage (III/3)	250 V
Rated impulse voltage (III/3)	4 kV
Rated current	13.5 A
Legend (ratings)	(III / 3) ≙ Overvoltage category III / Pollution degree 3

Ratings per UL 1059

Approvals per	UL 1059
Rated voltage UL (Use Group B)	300 V
Rated current UL (Use Group B)	15 A
Rated voltage UL (Use Group D)	300 V
Rated current UL (Use Group D)	15 A

Ratings per CSA

Approvals per	CSA 22.2 No 158
Rated voltage CSA (Use Group C)	300 V
Rated current CSA (Use Group C)	10 A

Power loss

Power loss, per pole (potential)	0.434 W
Rated current I_N for specified power loss	13.5 A
Resistance value for specified, current-dependent power loss	0.002 Ω

Connection data

Connection points	8
-------------------	---

Subject to changes. Please also observe the further product documentation!



Total number of potentials	4
Number of levels	3
Number of jumper slots	4
Anzahl Brückeraufnahmen Rang	1

Connection 1

Connection technology	Push-in CAGE CLAMP®
Actuation type	Operating tool
Connectable conductor materials	Copper Copper
Nominal cross-section	1 mm ²
Solid conductor	0.14 ... 1.5 mm ² / 24 ... 16 AWG
Solid conductor; push-in termination	0.5 ... 1.5 mm ² / 20 ... 16 AWG
Fine-stranded conductor	0.14 ... 1.5 mm ² / 24 ... 16 AWG
Fine-stranded conductor; with insulated ferrule	0.14 ... 0.75 mm ² / 24 ... 18 AWG
Fine-stranded conductor; with ferrule; push-in termination	0.5 ... 0.75 mm ² / 20 ... 18 AWG
Note (conductor cross-section)	Depending on the conductor characteristic, a conductor with a smaller cross-section can also be inserted via push-in termination.
Strip length	9 ... 11 mm / 0.35 ... 0.43 inches
Wiring direction	Front-entry wiring

Physical data

Width	7 mm / 0.276 inches
Height	81.1 mm / 3.193 inches
Depth from upper-edge of DIN-rail	52.4 mm / 2.063 inches

Mechanical Data

Mounting type	DIN-35 rail DIN-35 rail
Marking level	Center/side marking

Material Data

Note (material data)	Information on material specifications can be found here
Color	gray
Material group	I

Subject to changes. Please also observe the further product documentation!

Insulation material	Polyamide (PA66)
Flammability class per UL94	V0
Fire load	0.336 MJ
Weight	14.9 g

Environmental requirements

Processing temperature	-35 ... +85 °C
Continuous operating temperature	-60 ... +105 °C

Commercial data



eCl@ss 10.0	27-14-11-28
eCl@ss 9.0	27-14-11-28
ETIM 8.0	EC000900
ETIM 7.0	EC000900
PU (SPU)	50 pcs
Packaging type	Box
Country of origin	DE
GTIN	4055143393454
Customs tariff number	85369010000

Environmental Product Compliance

RoHS Compliance Status	Compliant, No Exemption
------------------------	-------------------------

Approvals / Certificates



General approvals

Logo	Approval	Additional Approval Text	Certificate name
	CCA DEKRA Certification B.V.	EN 60947	NTR NL 7962
	CSA DEKRA Certification B.V.	C22.2	2130762
	KEMA/KEUR DEKRA Certification B.V.	EN 60947	71- 125928

Subject to changes. Please also observe the further product documentation!

	UL Underwriters Laboratories Inc.	UL 1059	E45172
--	---	---------	--------

Declarations of conformity and manufacturer's declarations

Logo	Approval	Additional Approval Text	Certificate name
	EU-Declaration of Conformity WAGO GmbH & Co. KG	-	-
	Railway WAGO GmbH & Co. KG	-	Railway Ready
	UK-Declaration of Conformity WAGO GmbH & Co. KG	-	-

Required accessories

End plate

End plate	Item no.: 2000-5391 End and intermediate plate; 1 mm thick; for 3-conductor terminal blocks; gray	www.wago.com/2000-5391
-----------	---	--

Optional accessories

Jumpers

Jumper	Item no.: 210-123 Wire commoning chain; insulated; blue	www.wago.com/210-123
	Item no.: 2000-408 Jumper; 8-way; insulated; light gray	www.wago.com/2000-408
	Item no.: 2000-407 Jumper; 7-way; insulated; light gray	www.wago.com/2000-407
	Item no.: 2000-409 Jumper; 9-way; insulated; light gray	www.wago.com/2000-409

Subject to changes. Please also observe the further product documentation!

WAGO GmbH & Co. KG
 Hansastr. 27
 32423 Minden
 Phone: +49571 887-0 | Fax: +49571 887-169
 Email: info.de@wago.com | Web: www.wago.com

Do you have any questions about our products?
 We are always happy to take your call at +49 (571) 887-44222.



Item no.: 2000-408/000-006
Jumper; 8-way; insulated; blue

www.wago.com/2000-408/000-006



Item no.: 2000-408/000-005
Jumper; 8-way; insulated; red

www.wago.com/2000-408/000-005



Item no.: 2000-409/000-005
Jumper; 9-way; insulated; red

www.wago.com/2000-409/000-005



Item no.: 2000-407/000-006
Jumper; 7-way; insulated; blue

www.wago.com/2000-407/000-006



Item no.: 2000-410
Jumper; 10-way; insulated; light gray

www.wago.com/2000-410



Item no.: 2000-410/000-006
Jumper; 10-way; insulated; blue

www.wago.com/2000-410/000-006



Item no.: 2000-433/000-005
Jumper; from 1 to 3; insulated; red

www.wago.com/2000-433/000-005



Item no.: 2000-407/000-005
Jumper; 7-way; insulated; red

www.wago.com/2000-407/000-005



Item no.: 2000-433/000-006
Jumper; from 1 to 3; insulated; blue

www.wago.com/2000-433/000-006



Item no.: 2000-410/000-005
Jumper; 10-way; insulated; red

www.wago.com/2000-410/000-005



Item no.: 2000-435
Jumper; from 1 to 5; insulated; light gray

www.wago.com/2000-435



Item no.: 2000-409/000-006
Jumper; 9-way; insulated; blue

www.wago.com/2000-409/000-006



Item no.: 2000-436
Jumper; from 1 to 6; insulated; light gray

www.wago.com/2000-436



Item no.: 2000-433

Subject to changes. Please also observe the further product documentation!

Jumper; from 1 to 3; insulated; light gray

www.wago.com/2000-433



Item no.: 2000-434

Jumper; from 1 to 4; insulated; light gray

www.wago.com/2000-434



Item no.: 2000-402

Jumper; 2-way; insulated; light gray

www.wago.com/2000-402



Item no.: 2000-402/000-006

Jumper; 2-way; insulated; blue

www.wago.com/2000-402/000-006



Item no.: 2000-403

Jumper; 3-way; insulated; light gray

www.wago.com/2000-403



Item no.: 2000-402/000-005

Jumper; 2-way; insulated; red

www.wago.com/2000-402/000-005



Item no.: 2000-402/000-018

Jumper; 2-way; insulated; yellow-green

www.wago.com/2000-402/000-018



Item no.: 2000-404

Jumper; 4-way; insulated; light gray

www.wago.com/2000-404



Item no.: 2000-403/000-005

Jumper; 3-way; insulated; red

www.wago.com/2000-403/000-005



Item no.: 2000-404/000-006

Jumper; 4-way; insulated; blue

www.wago.com/2000-404/000-006



Item no.: 2000-403/000-006

Jumper; 3-way; insulated; blue

www.wago.com/2000-403/000-006



Item no.: 2000-404/000-005

Jumper; 4-way; insulated; red

www.wago.com/2000-404/000-005



Item no.: 2000-405

Jumper; 5-way; insulated; light gray

www.wago.com/2000-405



Item no.: 2000-405/011-000

Star point jumper; 3-way; insulated; light gray

www.wago.com/2000-405/011-000



Item no.: 2000-405/000-006

Jumper; 5-way; insulated; blue

www.wago.com/2000-405/000-006

Subject to changes. Please also observe the further product documentation!

WAGO GmbH & Co. KG

Hansastr. 27

32423 Minden

Phone: +49571 887-0 | Fax: +49571 887-169

Email: info.de@wago.com | Web: www.wago.com

Do you have any questions about our products?

We are always happy to take your call at +49 (571) 887-44222.



Item no.: 2000-406/000-006
Jumper; 6-way; insulated; blue

www.wago.com/2000-406/000-006



Item no.: 2000-405/000-005
Jumper; 5-way; insulated; red

www.wago.com/2000-405/000-005



Item no.: 2000-406
Jumper; 6-way; insulated; light gray

www.wago.com/2000-406



Item no.: 2000-406/000-005
Jumper; 6-way; insulated; red

www.wago.com/2000-406/000-005



Item no.: 2000-406/020-000
Delta jumper; insulated; light gray

www.wago.com/2000-406/020-000



Item no.: 2000-437
Jumper; from 1 to 7; insulated; light gray

www.wago.com/2000-437



Item no.: 2000-438
Jumper; from 1 to 8; insulated; light gray

www.wago.com/2000-438



Item no.: 2000-439
Jumper; from 1 to 9; insulated; light gray

www.wago.com/2000-439



Item no.: 2000-440
Jumper; from 1 to 10; insulated; light gray

www.wago.com/2000-440



Item no.: 210-103
Wire commoning chain; insulated; black

www.wago.com/210-103

Protective warning marker

Cover



Item no.: 2000-115
Protective warning marker; for 5 terminal blocks; with high-voltage symbol, black; yellow

www.wago.com/2000-115

Ferrule

Ferrule



Item no.: 216-241
Ferrule; Sleeve for 0.5 mm² / 20 AWG; insulated; electro-tin plated; electrolytic copper; gastight crimped; acc. to DIN 46228, Part 4/09.90; white

www.wago.com/216-241



Item no.: 216-242
Ferrule; Sleeve for 0.75 mm² / 18 AWG; insulated; electro-tin plated; electrolytic copper; gastight crimped; acc. to DIN 46228, Part 4/09.90; gray

www.wago.com/216-242



Item no.: 216-243
Ferrule; Sleeve for 1 mm² / AWG 18; insulated; electro-tin plated; electrolytic copper; gastight crimped; acc. to DIN 46228, Part 4/09.90; red

www.wago.com/216-243

Subject to changes. Please also observe the further product documentation!

WAGO GmbH & Co. KG

Hansastr. 27

32423 Minden

Phone: +49571 887-0 | Fax: +49571 887-169

Email: info.de@wago.com | Web: www.wago.com

Do you have any questions about our products?

We are always happy to take your call at +49 (571) 887-44222.

Marking accessories

Marking strip



Item no.: 2009-110

Marking strips; for Smart Printer; on reel; not stretchable; plain; snap-on type; white

www.wago.com/2009-110

Marker carrier



Item no.: 2000-121

Adaptor; gray

www.wago.com/2000-121

Marker



Item no.: 2009-113

WMB-Inline; for Smart Printer; 2300 pieces on roll; plain; snap-on type; white

www.wago.com/2009-113



Item no.: 2009-113/000-002

WMB-Inline; for Smart Printer; 2300 pieces on roll; plain; snap-on type; yellow

www.wago.com/2009-113

/000-002



Item no.: 2009-113/000-012

WMB-Inline; for Smart Printer; 2300 pieces on roll; plain; snap-on type; orange

www.wago.com/2009-113

/000-012



Item no.: 2009-113/000-007

WMB-Inline; for Smart Printer; 2300 pieces on roll; plain; snap-on type; gray

www.wago.com/2009-113

/000-007



Item no.: 2009-113/000-005

WMB-Inline; for Smart Printer; 2300 pieces on roll; plain; snap-on type; red

www.wago.com/2009-113

/000-005



Item no.: 2009-113/000-017

WMB-Inline; for Smart Printer; 2300 pieces on roll; plain; snap-on type; light green

www.wago.com/2009-113

/000-017



Item no.: 2009-113/000-006

WMB-Inline; for Smart Printer; 2300 pieces on roll; plain; snap-on type; blue

www.wago.com/2009-113

/000-006



Item no.: 2009-113/000-024

WMB-Inline; for Smart Printer; 2300 pieces on roll; plain; snap-on type; violet

www.wago.com/2009-113

/000-024



Item no.: 2009-113/000-023

WMB-Inline; for Smart Printer; 2300 pieces on roll; plain; snap-on type; green

www.wago.com/2009-113

/000-023



Item no.: 793-3501

WMB marking card; as card; plain; snap-on type; white

www.wago.com/793-3501

Group marker carrier

Subject to changes. Please also observe the further product documentation!

WAGO GmbH & Co. KG

Hansastr. 27

32423 Minden

Phone: +49571 887-0 | Fax: +49571 887-169

Email: info.de@wago.com | Web: www.wago.com

Do you have any questions about our products?

We are always happy to take your call at +49 (571) 887-44222.



Item no.: 2009-191
Group marker carrier; gray

www.wago.com/2009-191

Push-in type wire jumper

Jumper



Item no.: 2009-404
Push-in type wire jumper; 0.75 mm²; insulated; 110 mm long; gray

www.wago.com/2009-404



Item no.: 2009-402
Push-in type wire jumper; 0.75 mm²; insulated; 60 mm long; gray

www.wago.com/2009-402



Item no.: 2009-406
Push-in type wire jumper; 0.75 mm²; insulated; 250 mm long; gray

www.wago.com/2009-406

Carrier rail

Mounting accessories



Item no.: 210-197
Steel carrier rail; 35 x 15 mm; 1.5 mm thick; 2 m long; slotted; similar to EN 60715; silver-colored

www.wago.com/210-197



Item no.: 210-198
Copper carrier rail; 35 x 15 mm; 2.3 mm thick; 2 m long; unslotted; according to EN 60715; copper-colored

www.wago.com/210-198



Item no.: 210-113
Steel carrier rail; 35 x 7.5 mm; 1 mm thick; 2 m long; unslotted; according to EN 60715; silver-colored

www.wago.com/210-113

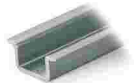

Item no.: 210-118
Steel carrier rail; 35 x 15 mm; 2.3 mm thick; 2 m long; unslotted; according to EN 60715; silver-colored

www.wago.com/210-118



Item no.: 210-112
Steel carrier rail; 35 x 7.5 mm; 1 mm thick; 2 m long; slotted; according to EN 60715; "Hole width 25 mm; silver-colored

www.wago.com/210-112



Item no.: 210-114
Steel carrier rail; 35 x 15 mm; 1.5 mm thick; 2 m long; unslotted; similar to EN 60715; silver-colored

www.wago.com/210-114



Item no.: 210-115
Steel carrier rail; 35 x 7.5 mm; 1 mm thick; 2 m long; slotted; according to EN 60715; "Hole width 18 mm; silver-colored

www.wago.com/210-115

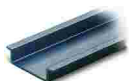

Item no.: 210-196
Aluminum carrier rail; 35 x 8.2 mm; 1.6 mm thick; 2 m long; unslotted; similar to EN 60715; silver-colored

www.wago.com/210-196

Mounting

Cover carrier



Item no.: 709-169
Cover carrier; Type 3; gray

www.wago.com/709-169

Cover

Subject to changes. Please also observe the further product documentation!



Item no.: 709-156
Cover; Type 3; suitable for cover carrier, type 3; 1 m long; transparent

www.wago.com/709-156

Tool

Operating tool



Item no.: 210-648
Operating tool; Blade: 2.5 x 0.4 mm; with a partially insulated shaft; angled; short

www.wago.com/210-648



Item no.: 210-647
Operating tool; Blade: 2.5 x 0.4 mm; with a partially insulated shaft; multicoloured

www.wago.com/210-647



Item no.: 210-719
Operating tool; Blade: 2.5 x 0.4 mm; with a partially insulated shaft

www.wago.com/210-719

Testing and measuring

Testing accessories



Item no.: 2009-174
Test plug adapter; for 4 mm Ø test plugs; for testing TOPJOB®S rail-mounted terminal blocks; gray

www.wago.com/2009-174



Item no.: 2009-182
Testing tap; for max. 2.5 mm²; tool-free connection for individual test wires 0.08 - 2.5 mm; gray

www.wago.com/2009-182

Downloads

Documentation

Bid Text

Item no.	Date	File type	Size	Action
2000-5310/102-000 X81 - Datei	2019 Feb 19	xml	4.1 kB	Download
2000-5310/102-000 docx - Datei	2018 Aug 7	docx	15.5 kB	Download

Additional Information

Section	File type	Size	Action
Technical Section Technical explanations	pdf	2.2 MB	Download

CAD/CAE-Data

CAD data

2D/3D Models 2000-5310/102-000

Subject to changes. Please also observe the further product documentation!

WAGO GmbH & Co. KG
Hansastr. 27
32423 Minden
Phone: +49571 887-0 | Fax: +49571 887-169
Email: info.de@wago.com | Web: www.wago.com

Do you have any questions about our products?
We are always happy to take your call at +49 (571) 887-44222.

[URL](#) [Download](#)

CAE data

EPLAN Data Portal 2000-5310/102-000 [URL](#) [Download](#)

ZUKEN Portal 2000-5310/102-000 [URL](#) [Download](#)

EPLAN Data Portal 2000-5310/102-000 [URL](#) [Download](#)

Environmental Product Compliance

Compliance Search

Environmental Product Compliance 2000-5310/102-000 [URL](#) [Download](#)

3-conductor actuator supply terminal block; for PNP-(high-side) switching actuators; with ground connection via push-in type jumper bars; with colored conductor entries; 1 mm²; Push-in CAGE CLAMP®; 1,00 mm²; gray

Installation Notes

Conductor termination

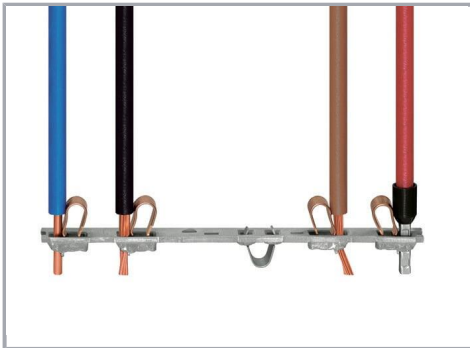

All conductor types at a glance

Commoning

Subject to changes. Please also observe the further product documentation!

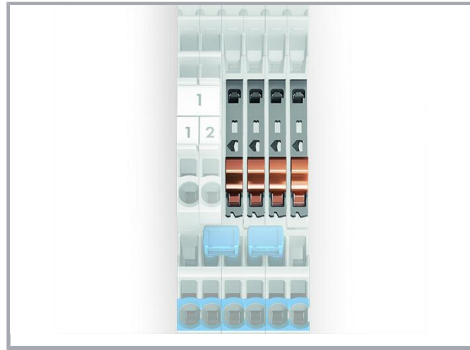
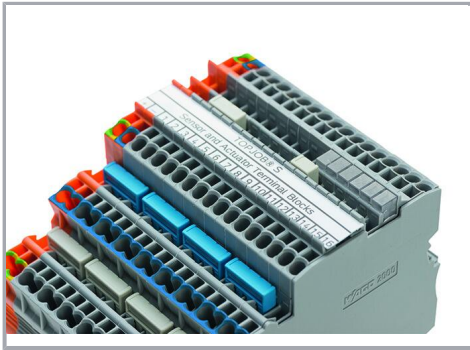

Commoning (signal level):

Upper level: Two independent signal pathways

Commoning the signal level with push-in type jumper bars (2000 Series). Models with an LED can only be commoned in one jumper slot!

TOPJOB® S Test Plug Adapters can be used in all jumper slots.

Commoning

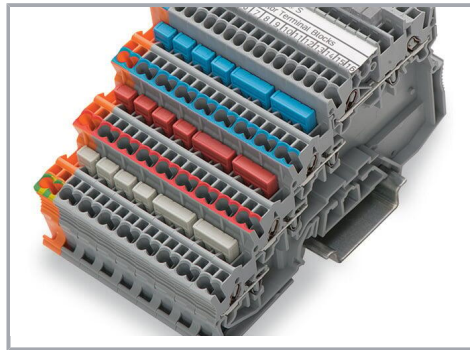

Commoning (potential level):

Commoning (potential level):

Commoning potential levels via push-in type jumper bars (2000 Series).

Continuous commoning in the potential levels via push-in type jumper bars for even pole numbers (2000 Series)

Subject to changes. Please also observe the further product documentation!

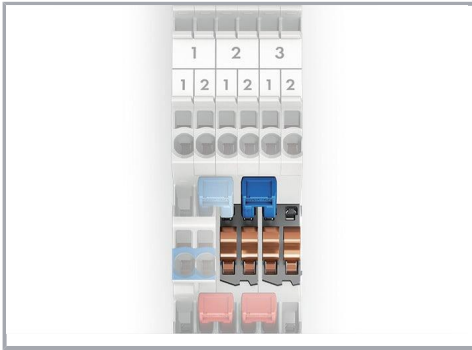

Potential levels: Two adjacent commoning options on a current bar

Commoning

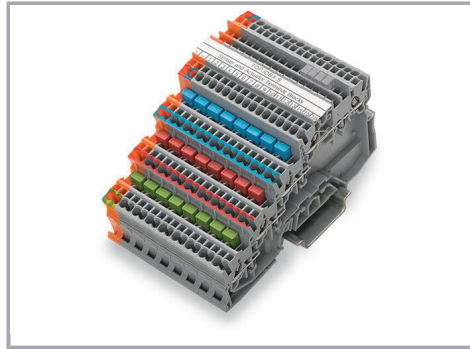
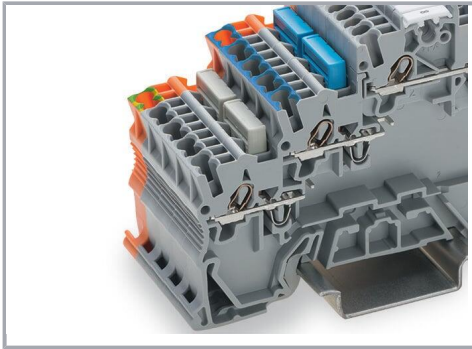

Ground commoning:

For sensor and actuator terminal blocks without ground connection to the DIN-rail, the ground connection can be performed by commoning to the terminal block with a ground foot.

For example, colored push-in type jumper bars are used with sensor terminal blocks.

Testing

Subject to changes. Please also observe the further product documentation!

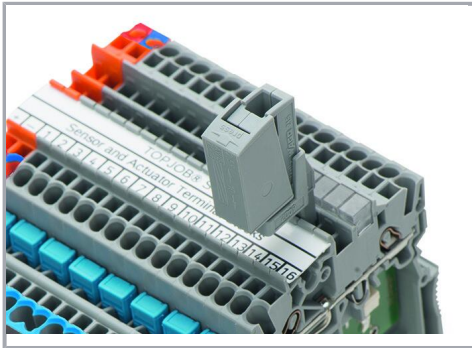

Testing via testing tap (2009-182) (up to max. 42 V).

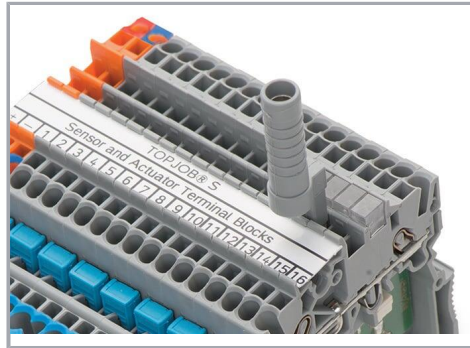

Testing via testing tap (2009-174) (up to max. 42 V).

Application



Supply:

Orange supply terminal block of same profile with a power supply option from both the cabinet and sensor sides

Subject to changes. Please also observe the further product documentation!

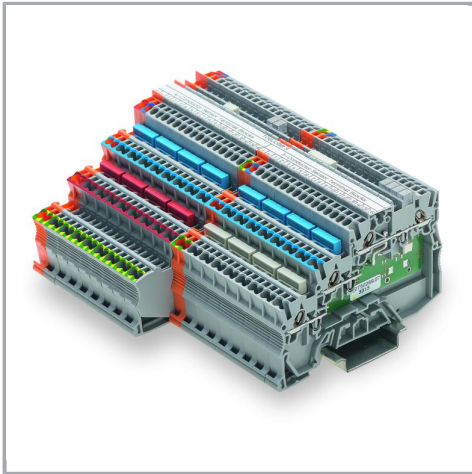

Terminal block assembly with 4-conductor sensor terminal blocks and 3-conductor actuator terminal blocks

Marking

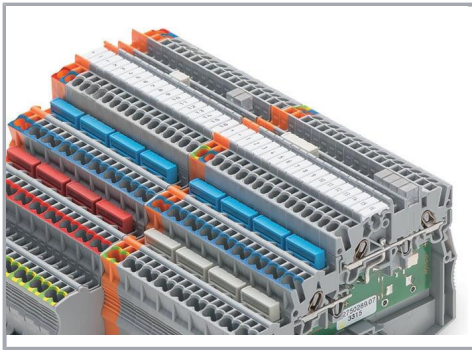

Marking:

3.5 mm WMB markers (793-35xx) from the top or the side – additional marking option via marker carrier

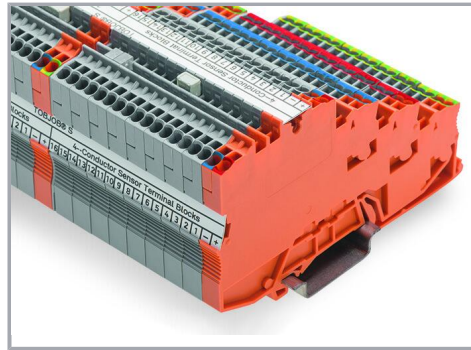

Marking:

Labeling via marking strips (2009-110) – from the top or the side.

Product family

TOPJOB® S

TOPJOB® S: In various industrial applications and modern building installations, WAGO's wide and versatile range of rail-mount terminal blocks provides more than just reliable electrical connections.

[Show all products from the family](#)

Subject to changes. Please also observe the further product documentation!