

Main Product Characteristics

$V_{(BR)DSS}$	-20V
$R_{DS(ON)}$	8mΩ
I_D	-60A

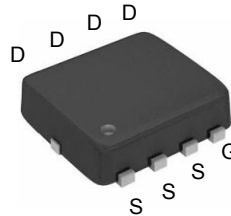

PPAK3x3

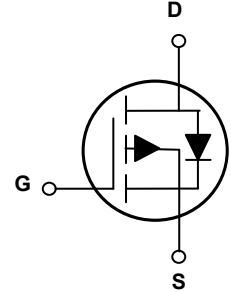

Schematic Diagram

Features and Benefits

- Advanced MOSFET process technology
- Ideal for high efficiency switched mode power supplies
- Low on-resistance with low gate charge
- Fast switching and reverse body recovery



Description

The SSFN2603 utilizes the latest techniques to achieve high cell density and low on-resistance. These features make this device extremely efficient and reliable for use in high efficiency switch mode power supply and a wide variety of other applications.

Absolute Maximum Ratings ($T_C=25^{\circ}C$ unless otherwise specified)

Parameter	Symbol	Rating	Unit
Drain-Source Voltage	V_{DS}	-20	V
Gate-Source Voltage	V_{GS}	±12	V
Drain Current – Continuous ($T_C=25^{\circ}C$)	I_D	-60	A
Drain Current – Continuous ($T_C=100^{\circ}C$)		-38	A
Drain Current – Pulsed ¹	I_{DM}	-240	A
Power Dissipation ($T_C=25^{\circ}C$)	P_D	62.5	W
Power Dissipation – Derate above 25°C		0.5	W/°C
Thermal Resistance Junction to Ambient	$R_{\theta JA}$	62	°C/W
Thermal Resistance Junction to Case	$R_{\theta JC}$	2	°C/W
Storage Temperature Range	T_{STG}	-55 to +150	°C
Operating Junction Temperature Range	T_J	-55 to +150	°C

Electrical Characteristics ($T_J=25^\circ\text{C}$ unless otherwise specified)

Parameter	Symbol	Conditions	Min.	Typ.	Max.	Unit
Off Characteristics						
Drain-Source Breakdown Voltage	BV_{DSS}	$V_{GS}=0V, I_D=-250\mu A$	-20	-	-	V
BV_{DSS} Temperature Coefficient	$\Delta BV_{DSS}/\Delta T_J$	Reference to 25°C , $I_D=-1mA$	-	-0.01	-	$V/^\circ\text{C}$
Drain-Source Leakage Current	I_{DSS}	$V_{DS}=-20V,$ $V_{GS}=0V, T_J=25^\circ\text{C}$	-	-	-1	μA
		$V_{DS}=-16V,$ $V_{GS}=0V, T_J=125^\circ\text{C}$	-	-	-10	μA
Gate-Source Leakage Current	I_{GSS}	$V_{GS}=\pm 12V, V_{DS}=0V$	-	-	± 100	nA
On Characteristics						
Static Drain-Source On-Resistance	$R_{DS(ON)}$	$V_{GS}=-4.5V, I_D=-8A$	-	6	8	$m\Omega$
		$V_{GS}=-2.5V, I_D=-5A$	-	8	11	$m\Omega$
		$V_{GS}=-1.8V, I_D=-3A$	-	11	16	$m\Omega$
Gate Threshold Voltage	$V_{GS(th)}$	$V_{GS}=V_{DS}, I_D=-250\mu A$	-0.3	-0.6	-1.0	V
Forward Transconductance	g_{fs}	$V_{DS}=-10V, I_D=-5A$	-	20	-	S
Dynamic and Switching Characteristics						
Total Gate Charge ^{2, 3}	Q_g	$V_{DS}=-10V,$ $V_{GS}=-4.5V, I_D=-5A$	-	44.4	80	nC
Gate-Source Charge ^{2, 3}	Q_{gs}		-	7.2	14	
Gate-Drain Charge ^{2, 3}	Q_{gd}		-	10.2	20	
Turn-On Delay Time ^{2, 3}	$T_{d(on)}$	$V_{DD}=-10V,$ $V_{GS}=-4.5V, R_G=25\Omega,$ $I_D=-1A$	-	13.2	26	nS
Rise Time ^{2,3}	T_r		-	68	120	
Turn-Off Delay Time ^{2, 3}	$T_{d(off)}$		-	160	320	
Fall Time ^{2, 3}	T_f		-	154	300	
Input Capacitance	C_{iss}	$V_{DS}=-15V,$ $V_{GS}=0V, F=1MHz$	-	4060	8000	pF
Output Capacitance	C_{oss}		-	520	1000	
Reverse Transfer Capacitance	C_{rss}		-	400	800	
Drain-Source Diode Characteristics and Maximum Ratings						
Parameter	Symbol	Conditions	Min.	Typ.	Max.	Unit
Continuous Source Current	I_S	$V_G=V_D=0V,$	-	-	-60	A
Pulsed Source Current	I_{SM}	Force Current	-	-	-120	A
Diode Forward Voltage	V_{SD}	$V_{GS}=0V, I_S=-1A,$ $T_J=25^\circ\text{C}$	-	-	-1	V

Note:

1. Repetitive Rating: Pulsed width limited by maximum junction temperature.
2. Pulse test: pulse width $\leq 300\mu s$, duty cycle $\leq 2\%$.
3. Essentially independent of operating temperature.

Typical Electrical and Thermal Characteristic Curves

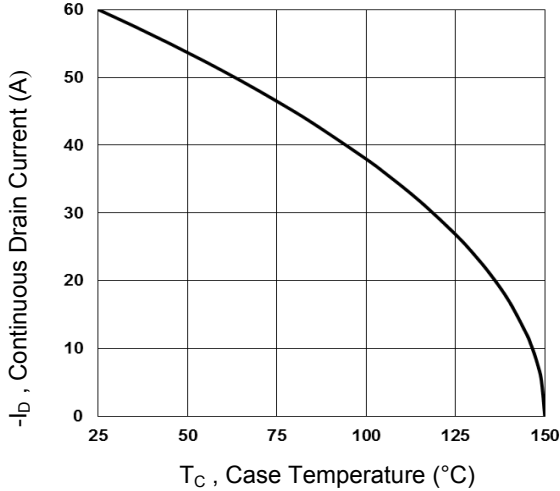

Figure 1. Continuous Drain Current vs. T_C

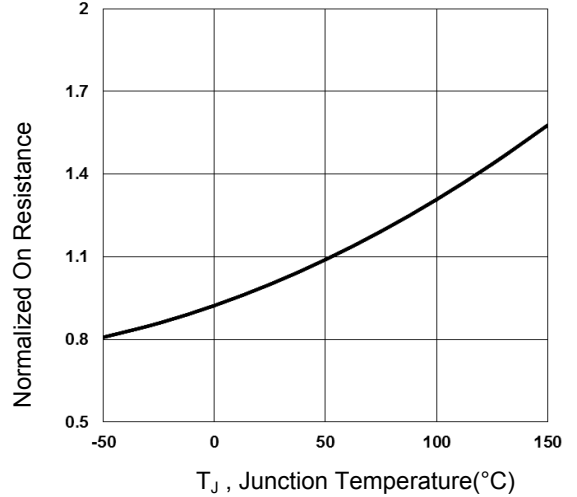

Figure 2. Normalized $R_{DS(ON)}$ vs. T_J

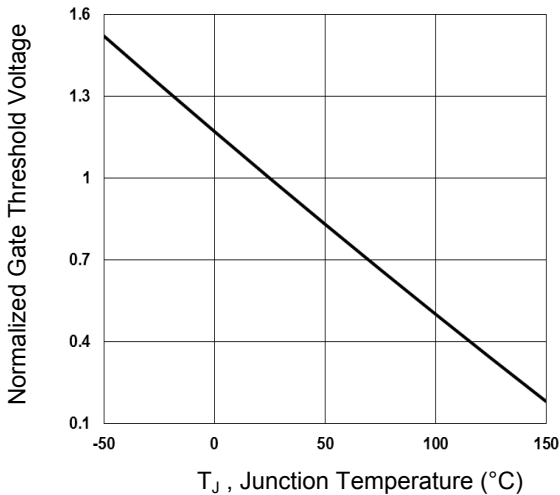

Figure 3. Normalized V_{th} vs. T_J

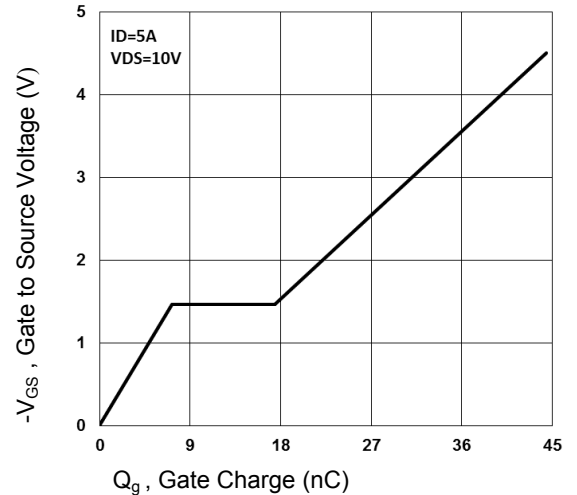

Figure 4. Gate Charge Waveform

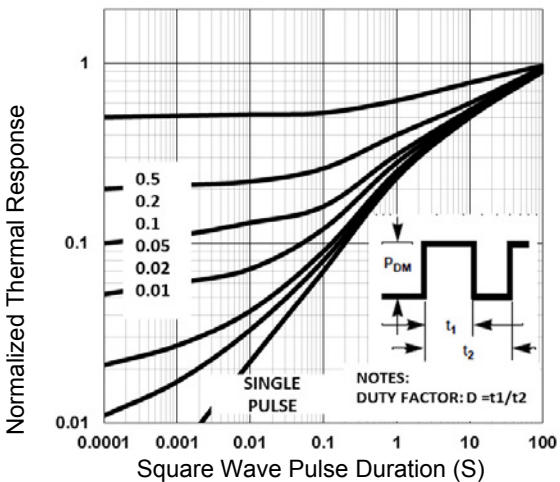

Figure 5. Normalized Transient Response

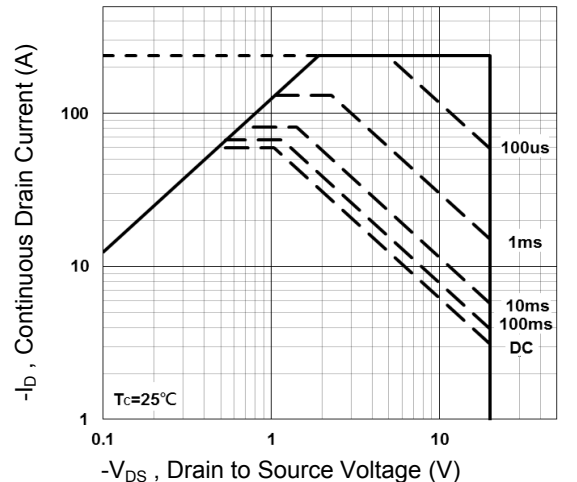

Figure 6. Maximum Safe Operation Area

Typical Electrical and Thermal Characteristic Curves

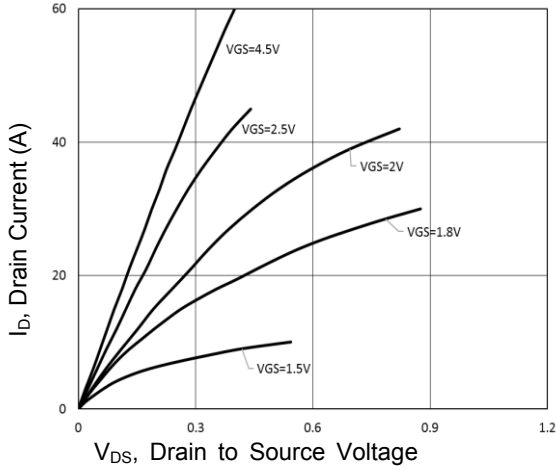

Figure 7. Typical Output Characteristics

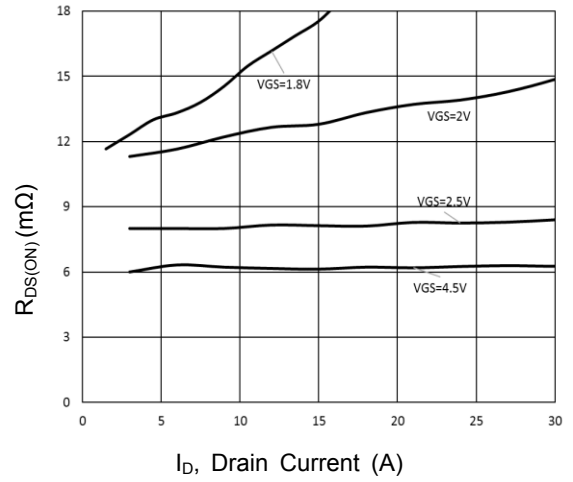

Figure 8. $R_{DS(ON)}$ vs. Drain Current

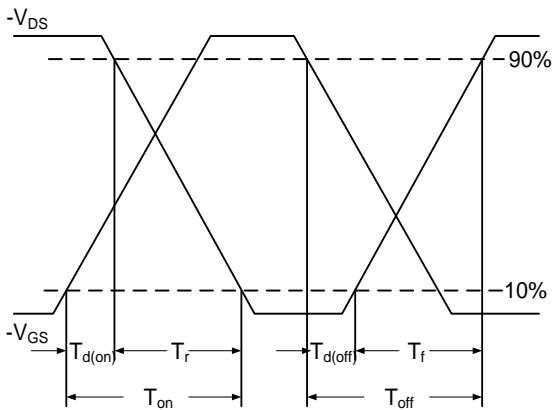

Figure 9. Switching Time Waveform

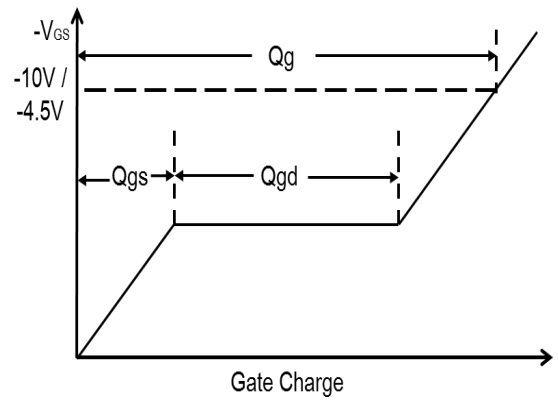
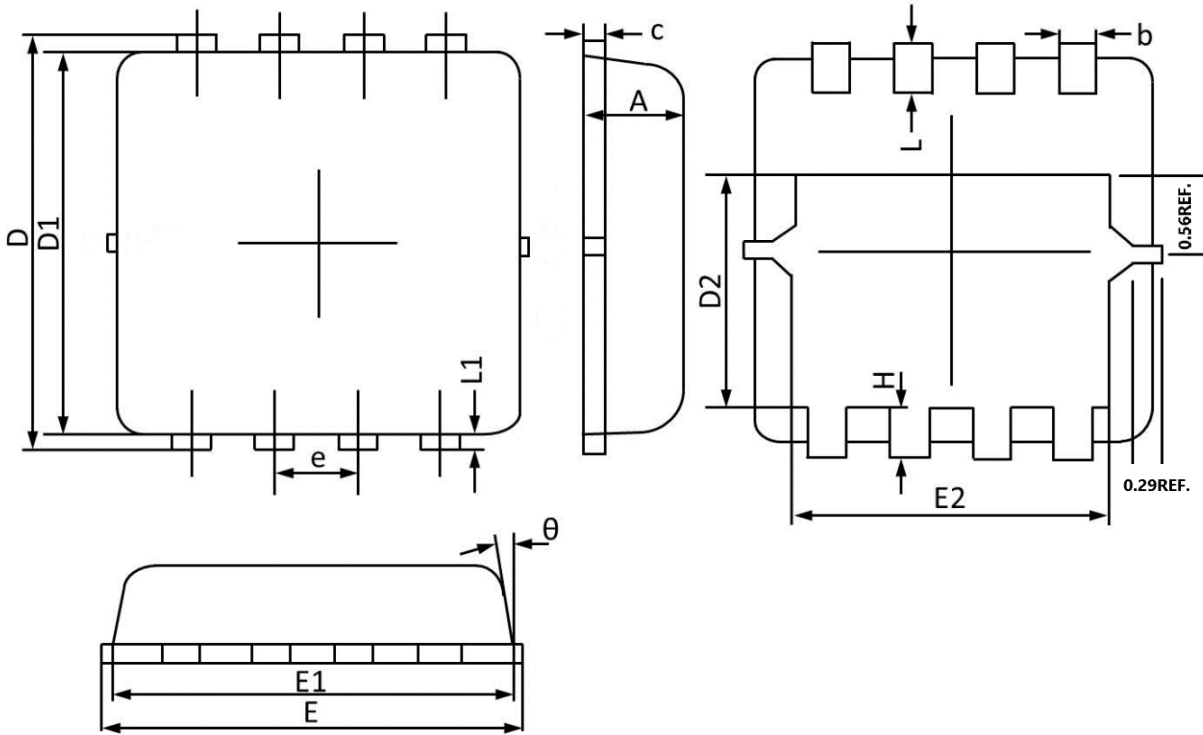

Figure 10. Gate Charge Waveform

Package Outline Dimensions (PPAK3x3)



Symbol	Dimensions In Millimeters		Dimensions In Inches	
	MAX	MIN	MAX	MIN
A	0.900	0.700	0.035	0.028
b	0.350	0.250	0.014	0.010
c	0.250	0.100	0.010	0.004
D	3.500	3.050	0.138	0.120
D1	3.200	2.900	0.126	0.114
D2	1.950	1.350	0.077	0.053
E	3.400	3.000	0.134	0.118
E1	3.300	2.900	0.130	0.114
E2	2.600	2.350	0.102	0.093
e	0.65BSC		0.026BSC	
H	0.750	0.300	0.030	0.012
L	0.600	0.300	0.024	0.012
L1	0.200	0.060	0.008	0.002
θ	14°	6°	14°	6°

Recommended Pad Layout

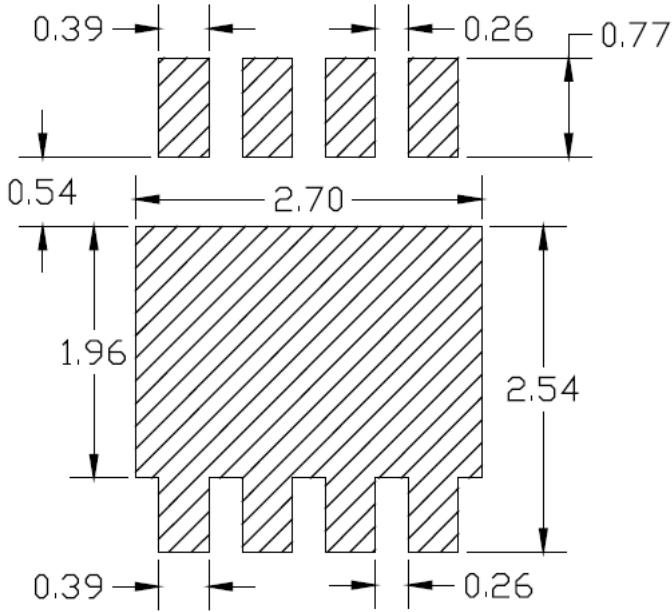

unit : mm