

QXK-(ZH)

Metallized Polyester Film Capacitor

(Extended Standard Type)

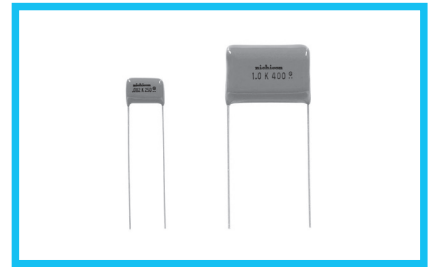

- Highly reliable and superior performance in high frequency applications, self-healing and non-inductive construction, using a dielectric made of polyethylene terephthalate film covered with vacuum-evaporated metal.
- Finished by inner dipping with liquid epoxy resin and outer coating with flame-retardant epoxy resin, those double coating provides excellent humidity resistance.
- Designed to be compact and to cover larger capacitance range having advantage of tolerating to A.C.voltage and large current flow.
- Designed 1mm max. of epoxy on lead wire for best performance at soldering process on P.C. board assemblies.
- Compliant to the RoHS directive (2011/65/EU,(EU)2015/863).

Applications

- Filtering, DC-blocking, coupling and so on of general communications equipment and use in AC circuits for motor starting, charging / discharging, lighting, noise suppression and etc. Contact us for details for use in AC circuits.
- However, do not use this product for across-the-line applications.

Specifications

Item	Performance Characteristics
Category Temperature Range	-40 to +105°C (Rated temperature : 85°C)
Rated Voltage (U _R)	250, 400, 630VDC
Rated Capacitance Range	0.01 to 3.3μF
Rated Capacitance Tolerance	±5% (J), ±10% (K)
Dielectric Loss Tangent	0.8% or less (at 1kHz 20°C)
Insulation Resistance	C ≤ 0.33μF : 9000 MΩ or more C > 0.33μF : 3000 ΩF or more
Withstand Voltage	Between Terminals : Rated Voltage × 175%, 1 to 5 secs. Between Terminals and Coverage : Rated Voltage × 200%, 1 to 5 secs.
Encapsulation	Flame-retardant epoxy resin

Category voltage = UR × 0.7

Type numbering system (Example : 630V 0.01μF)

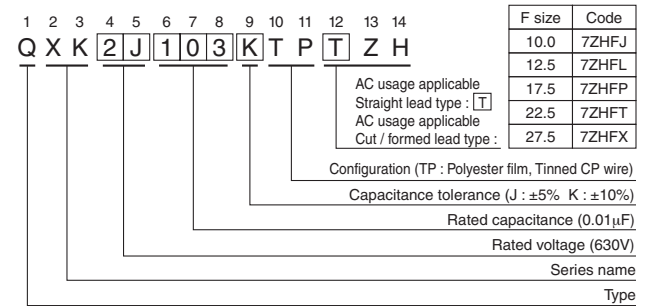

AC Voltage

- AC voltage (Operating at 50 / 60Hz AC circuit) shall be as follows. However, do not use this product for across-the-line applications.

	250VDC	400VDC	630VDC
DC Rated Voltage	250VDC	400VDC	630VDC
AC Voltage	125VAC	200VAC	250VAC

- When used in high frequency circuit, refer to Table 2 and 3 in the Guidelines for Plastic Film Capacitors for the values of effective voltage, current and effective VA.

Drawing

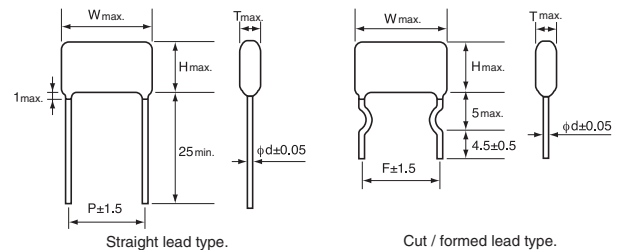

Dimensions

Cap.(μF)	V(Code)	Code	Size	250VDC (2E)						400VDC (2G)						630VDC (2J)					
				T	W	H	d	P	F	T	W	H	d	P	F	T	W	H	d	P	F
0.01	103															4.8	15.5	9.4	0.6	12.5	12.5
0.015	153															5.5	15.5	10.0	0.6	12.5	12.5
0.022	223								4.9	13.5	9.5	0.6	10.5	10.0		6.3	15.5	10.8	0.6	12.5	12.5
0.033	333								5.6	13.5	10.2	0.6	10.5	10.0		7.1	15.5	12.3	0.6	12.5	12.5
0.047	473			4.7	13.5	9.3	0.6	10.5	10.0	5.5	15.5	10.1	0.6	12.5	12.5	6.2	20.5	11.5	0.6	17.5	17.5
0.068	683			4.7	13.5	9.3	0.6	10.5	10.0	6.3	15.5	10.9	0.6	12.5	12.5	6.7	20.5	13.5	0.6	17.5	17.5
0.1	104			5.3	13.5	9.9	0.6	10.5	10.0	7.3	15.5	11.9	0.6	12.5	12.5	7.8	20.5	14.6	0.6	17.5	17.5
0.15	154			5.5	15.5	10.1	0.6	12.5	12.5	6.6	20.5	11.8	0.6	17.5	17.5	8.0	26.0	15.3	0.8	22.5	22.5
0.22	224			6.3	15.5	10.9	0.6	12.5	12.5	7.7	20.5	12.9	0.6	17.5	17.5	8.9	26.0	17.6	0.8	22.5	22.5
0.33	334			7.4	15.5	12.0	0.6	12.5	12.5	8.6	20.5	15.3	0.6	17.5	17.5	10.9	26.0	19.8	0.8	22.5	22.5
0.47	474			6.7	20.5	11.9	0.6	17.5	17.5	10.1	20.5	16.9	0.6	17.5	17.5	11.3	31.0	20.2	0.8	27.5	27.5
0.68	684			7.2	20.5	14.0	0.6	17.5	17.5	9.5	26.0	18.4	0.8	22.5	22.5						
1.0	105			8.6	20.5	15.3	0.6	17.5	17.5	11.5	26.0	20.4	0.8	22.5	22.5						
1.5	155			8.3	26.0	17.1	0.8	22.5	22.5	12.3	31.0	21.1	0.8	27.5	27.5						
2.2	225			10.0	26.0	18.8	0.8	22.5	22.5												
3.3	335			10.7	31.0	19.6	0.8	27.5	27.5												

F : lead pitch for cut / formed lead wires

PLASTIC FILM CAPACITORS



QXK

Metallized Polyester Film Capacitor

(Extended Standard Type)



Smaller

- Highly reliable and superior performance in high frequency applications, self-healing and non-inductive construction, using a dielectric made of polyethylene terephthalate film covered with vacuum-evaporated metal.
- Large capacitance in small dimensions.
- Finished by inner dipping with liquid epoxy resin and outer coating with flame-retardant epoxy resin, those double coating provides excellent humidity resistance.
- Designed 1mm max. of epoxy on lead wire for best performance at soldering process on P.C. board assemblies.
- Compliant to the RoHS directive (2011/65/EU,(EU)2015/863).

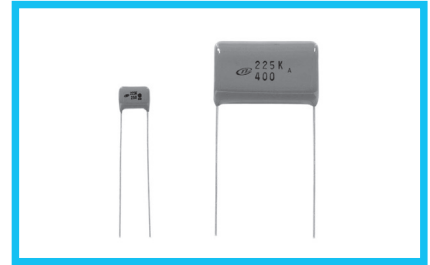

Applications

- General electronic and communications equipment. Contact us for details for use in AC circuits.
- However, do not use this product for across-the-line applications.

Specifications

Item	Performance Characteristics
Category Temperature Range	-40 to +105°C (Rated temperature : 85°C)
Rated Voltage (U _R)	250, 400, 630VDC
Rated Capacitance Range	0.01 to 10μF
Capacitance Tolerance	±5% (J)※, ±10% (K)
Dielectric Loss Tangent	0.8% or less (at 1kHz 20°C)
Insulation Resistance	C ≤ 0.33μF : 9000 MΩ or more C > 0.33μF : 3000 ΩF or more
Withstand Voltage	Between Terminals : Rated Voltage × 175%, 1 to 5 secs. Between Terminals and Coverage : Rated Voltage × 200%, 1 to 5 secs.
Encapsulation	Flame retardant epoxy resin

※ Except for 250VDC 0.01 to 0.15μF
400VDC 0.01 to 0.033μF

Category voltage = U_R × 0.7

Type numbering system (Example : 630V 0.01μF)

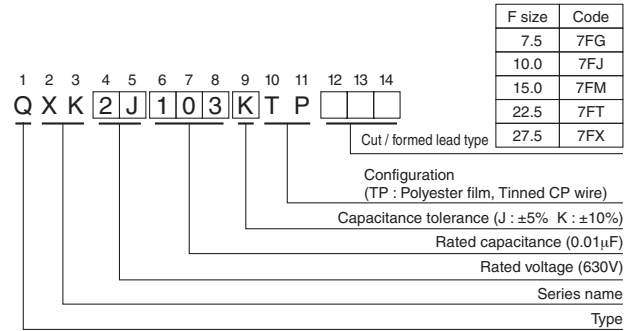

AC Voltage

- AC Voltage (Operating at 50 / 60Hz AC circuit) shall be as follows. However, do not use this product for across-the-line applications.

DC Rated Voltage	250VDC	400VDC	630VDC
AC Voltage	125VAC	200VAC	250VAC

※ When operating capacitors in the high frequency circuit, maximum permissible value (VAC) can be calculated from table 2, provided that the effective current (I_e) and the effective VA (V_e × V_e) shall not exceed the values specified in table 4. Shown in the Guidelines for Plastic Film Capacitors.

Drawing

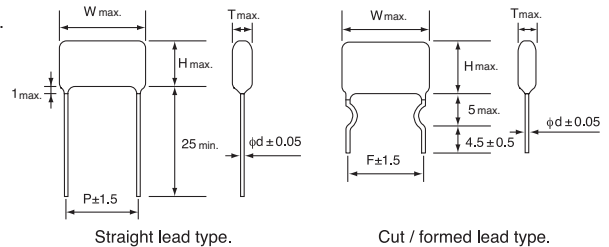

Dimensions

V(Code) Cap.(μF) Code Size		250VDC (2E)							400VDC (2G)							630VDC (2J)						
		T	W	H	d	P	F	T	W	H	d	P	F	T	W	H	d	P	F			
0.01	103	4.4	11.0	8.1	0.6	7.5	7.5	4.4	11.0	8.1	0.6	7.5	7.5	4.4	13.5	9.5	0.6	10.0	10.0			
0.015	153	5.0	11.0	8.7	0.6	7.5	7.5	5.0	11.0	8.7	0.6	7.5	7.5	4.7	13.5	9.8	0.6	10.0	10.0			
0.022	223	4.4	11.0	8.5	0.6	7.5	7.5	4.3	11.0	8.4	0.6	7.5	7.5	5.1	13.5	10.8	0.6	10.0	10.0			
0.033	333	4.4	11.0	8.5	0.6	7.5	7.5	4.9	11.0	9.1	0.6	7.5	7.5	5.9	13.5	11.6	0.6	10.0	10.0			
0.047	473	4.0	11.0	8.1	0.6	7.5	7.5	4.7	13.5	9.8	0.6	10.0	10.0	6.4	13.5	13.7	0.6	10.0	10.0			
0.068	683	4.7	11.0	8.7	0.6	7.5	7.5	5.4	13.5	10.5	0.6	10.0	10.0	5.8	18.5	11.5	0.6	15.0	15.0			
0.1	104	5.2	11.0	9.4	0.6	7.5	7.5	6.1	13.5	11.7	0.6	10.0	10.0	6.4	18.5	13.7	0.6	15.0	15.0			
0.15	154	6.1	11.0	10.3	0.6	7.5	7.5	5.1	18.5	12.4	0.6	15.0	15.0	7.1	18.5	15.9	0.6	15.0	15.0			
0.22	224	5.9	13.5	11.0	0.6	10.0	10.0	5.9	18.5	13.2	0.6	15.0	15.0	9.6	18.5	15.3	0.6	15.0	15.0			
0.33	334	6.7	13.5	12.4	0.6	10.0	10.0	7.6	18.5	13.3	0.6	15.0	15.0	7.9	25.5	16.7	0.8	22.5	22.5			
0.47	474	5.5	18.5	12.8	0.6	15.0	15.0	8.3	18.5	15.6	0.6	15.0	15.0	9.4	25.5	18.2	0.8	22.5	22.5			
0.68	684	6.0	18.5	14.8	0.6	15.0	15.0	7.2	25.5	16.1	0.8	22.5	22.5	11.3	25.5	20.1	0.8	22.5	22.5			
1.0	105	7.1	18.5	16.0	0.6	15.0	15.0	8.7	25.5	17.6	0.8	22.5	22.5	12.0	30.5	21.0	0.8	27.5	27.5			
1.5	155	9.9	18.5	15.6	0.6	15.0	15.0	9.4	30.5	18.5	0.8	27.5	27.5	14.8	30.5	23.8	0.8	27.5	27.5			
2.2	225	8.1	25.5	17.0	0.8	22.5	22.5	11.5	30.5	20.5	0.8	27.5	27.5	18.5	30.5	28.0	0.8	27.5	27.5			
3.3	335	10.0	25.5	18.8	0.8	22.5	22.5															
4.7	475	12.0	25.5	20.8	0.8	22.5	22.5															
6.8	685	12.7	30.5	21.8	0.8	27.5	27.5															
10.0	106	15.6	30.5	24.7	0.8	27.5	27.5															

F : lead pitch for cut / formed lead wires

Since rating other than the above can be manufactured, please ask for detail.

QXP

Metallized Polypropylene Film Capacitor

(For High Frequency Applications)



- Ideal for high frequency applications due to a metallized polypropylene film dielectric which exhibits superior operative characteristics with minimal loss at high frequency.
- Self-healing electrode and non-inductive construction provide excellent characteristics in minimal inductance having better with standing voltage capability.
- Finished by inner dipping with liquid epoxy resin and outer coating with flame-retardant epoxy resin, those double coating gives superior characteristics against moisture.
- Compliant to the RoHS directive (2011/65/EU, (EU)2015/863).

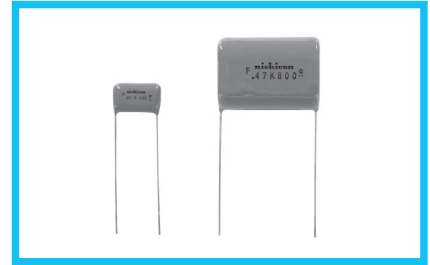

Application

- High frequency circuit, general electronic circuit and etc.

Specifications

Item	Performance Characteristics
Category Temperature Range	-40 to +105°C (Rated temperature : 85°C)
Rated Voltage (U _R)	250, 400, 630, 800VDC
Rated Capacitance Range	0.01 to 3.3μF
Capacitance Tolerance	±5% (J), ±10% (K)
Dielectric Loss Tangent	0.1% or less (at 1kHz 20°C)
Insulation Resistance	C ≤ 0.33μF : 30000 MΩ or more C > 0.33μF : 10000 ΩF or more
Withstand Voltage	Between Terminals : Rated Voltage × 175%, 1 to 5 secs. Between Terminals and Coverage : Rated Voltage × 200%, 1 to 5 secs.
Encapsulation	Flame retardant epoxy resin

Category voltage = U_R × 0.7

Type numbering system (Example : 630V 0.01μF)

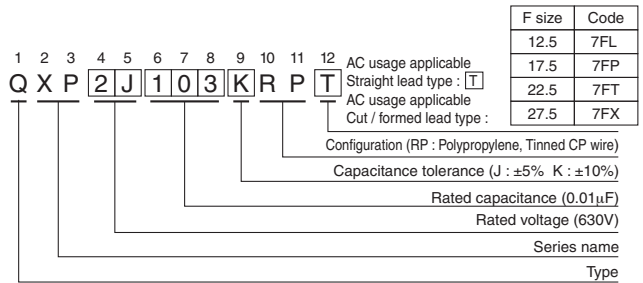

AC Voltage

- AC voltage (Operating at 50 / 60Hz AC circuit) shall be as follows
However, do not use this product for across-the-line applications.

DC Rated Voltage	250VDC	400VDC	630VDC	800VDC
AC Voltage	125VAC	160VAC	200VAC	250VAC

- When used in high frequency circuit, refer to Table 2 and 5 for the values of effective voltage, current and effective VA, shown in the Guidelines for Plastic Film Capacitors.

Drawing

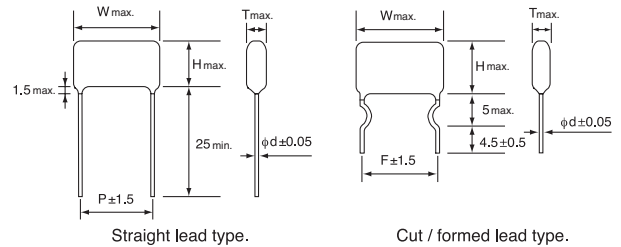

Dimensions

Unit : mm

Cap.(μF)	V (Code) Size Code	250VDC (2E)						400VDC (2G)						630VDC (2J)						800VDC (2K)						
		T	W	H	d	P	F	T	W	H	d	P	F	T	W	H	d	P	F	T	W	H	d	P	F	
0.01	103														5.5	16.0	10.6	0.6	12.5	12.5	6.2	16.0	11.3	0.6	12.5	12.5
0.015	153														6.1	16.0	11.1	0.6	12.5	12.5	7.0	16.0	12.1	0.6	12.5	12.5
0.022	223							5.8	16.0	10.4	0.6	12.5	12.5	6.8	16.0	11.8	0.6	12.5	12.5	8.0	16.0	13.1	0.6	12.5	12.5	
0.033	333							6.5	16.0	11.6	0.6	12.5	12.5	7.5	16.0	12.2	0.6	12.5	12.5	7.1	21.0	12.8	0.6	17.5	17.5	
0.047	473	5.6	16.0	10.6	0.6	12.5	12.5	7.2	16.0	12.3	0.6	12.5	12.5	6.7	21.0	12.4	0.6	17.5	17.5	7.5	21.0	14.8	0.6	17.5	17.5	
0.068	683	6.1	16.0	11.2	0.6	12.5	12.5	8.2	16.0	13.3	0.6	12.5	12.5	7.1	21.0	14.4	0.6	17.5	17.5	8.7	21.0	15.9	0.6	17.5	17.5	
0.1	104	6.8	16.0	11.9	0.6	12.5	12.5	7.6	21.0	12.7	0.6	17.5	17.5	8.2	21.0	15.4	0.6	17.5	17.5	9.6	21.0	18.5	0.6	17.5	17.5	
0.15	154	7.7	16.0	12.8	0.6	12.5	12.5	8.6	21.0	14.3	0.6	17.5	17.5	9.6	21.0	16.9	0.6	17.5	17.5	9.6	26.5	19.0	0.8	22.5	22.5	
0.22	224	7.4	21.0	12.4	0.6	17.5	17.5	9.2	21.0	16.5	0.6	17.5	17.5	9.0	26.5	18.3	0.8	22.5	22.5	11.5	26.5	20.8	0.8	22.5	22.5	
0.33	334	8.5	21.0	13.6	0.6	17.5	17.5	11.1	21.0	18.3	0.6	17.5	17.5	10.7	26.5	20.1	0.8	22.5	22.5	12.1	31.5	21.5	0.8	27.5	27.5	
0.47	474	9.4	21.0	15.1	0.6	17.5	17.5	10.4	26.5	19.7	0.8	22.5	22.5	11.1	31.5	20.4	0.8	27.5	27.5	13.7	31.5	24.7	0.8	27.5	27.5	
0.68	684	10.3	21.0	17.5	0.6	17.5	17.5	12.3	26.5	21.6	0.8	22.5	22.5	13.2	31.5	22.5	0.8	27.5	27.5							
1.0	105	9.9	26.5	19.2	0.8	22.5	22.5	13.0	31.5	22.3	0.8	27.5	27.5													
1.5	155	11.8	26.5	21.2	0.8	22.5	22.5	14.9	31.5	25.9	0.8	27.5	27.5													
2.2	225	12.6	31.5	21.9	0.8	27.5	27.5																			
3.3	335	14.5	31.5	25.4	0.8	27.5	27.5																			

F : lead pitch for cut / formed lead wires

Since rating other than the above can be manufactured, please ask for detail.

QXT

Metallized Polypropylene Film Capacitor

(For High Frequency and Large Current Applications)



- Ideal for high frequency applications due to a metallized polypropylene film dielectric which exhibits superior operative characteristics with minimal loss at high frequency.
- Electrode has minimal inductance because of non-inductive construction.
- Finished by inner dipping with liquid epoxy resin and outer coating with flame-retardant epoxy resin, those double coating gives superior characteristics against moisture.
- Compliant to the RoHS directive (2011/65/EU, (EU)2015/863).

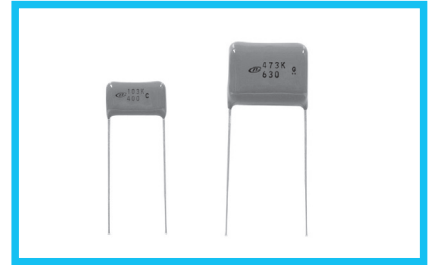

Applications

- High frequency & large current circuit applications (resonant circuit, charge & discharge circuit & etc.)

Specifications

Item	Performance Characteristics
Category Temperature Range	-40 to +105°C (Rated temperature : 85°C)
Rated Voltage (U _R)	400, 630VDC
Rated Capacitance Range	0.0068 to 0.1μF
Capacitance Tolerance	±10% (K)
Directic Loss Tangent	0.1% or less (at 1kHz)
Insulation Resistance	C ≤ 0.33μF 30000 MΩ or more C > 0.33μF 10000 ΩF or more
Withstand Voltage	Between Terminals : Rated Voltage × 175%, 1 to 5 secs. Between Terminals : Rated Voltage × 200%, 1 to 5 secs.
Encapsulation	Flame retardant epoxy resin

Category voltage = U_R × 0.7

Type numbering system (Example : 630V 0.01μF)

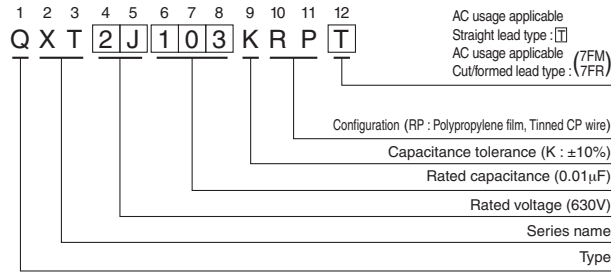

Drawing

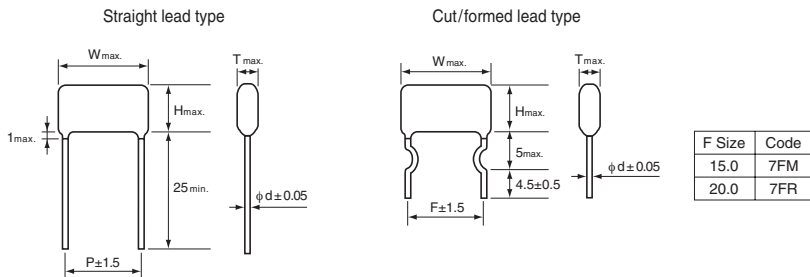

Maximum allowable voltage to high frequency range

Maximum allowable voltage differs by frequency and it is requested to refer the graphs shown in next page. Effective values for 200 kHz sine wave is indicated in the list below.

Dimensions

V (Code) (μF) Cap. Code Size	400VDC							Permissible Effective Value (200kHz)		630VDC						Permissible Effective Value (200kHz)	
	T	W	H	d	P	F	Ve(V)	Ie(A)	T	W	H	d	P	F	Ve(V)	Ie(A)	
0.0068	682									6.0	19	13.5	0.8	15	15	66	0.57
0.01	103	5.4	19	12.9	0.8	15	15	52	0.66	6.8	19	14.3	0.8	15	15	58	0.74
0.015	153	6.1	19	13.6	0.8	15	15	45	0.85	7.9	19	15.4	0.8	15	15	51	0.87
0.022	223	7.0	19	14.5	0.8	15	15	39	1.10	9.3	19	16.8	0.8	15	15	45	1.26
0.033	333	8.2	19	15.7	0.8	15	15	35	1.46	9.0	24	18.8	0.8	20	20	41	1.71
0.047	473	9.6	19	17.1	0.8	15	15	31	1.86	10.5	24	20.3	0.8	20	20	38	2.29
0.068	683	7.8	24	17.7	0.8	20	20	27	2.38	12.5	24	22.3	0.8	20	20	34	2.94
0.1	104	9.3	24	19.1	0.8	20	20	24	3.10								

F : lead pitch for cut / formed lead wires.

Since rating other than the above can be manufactured, please ask for detail.

QXT

Maximum permissible voltage used at higher frequency range (Sine Wave)

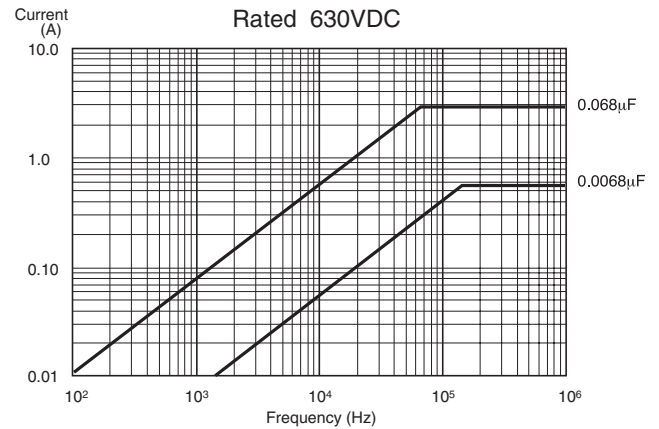
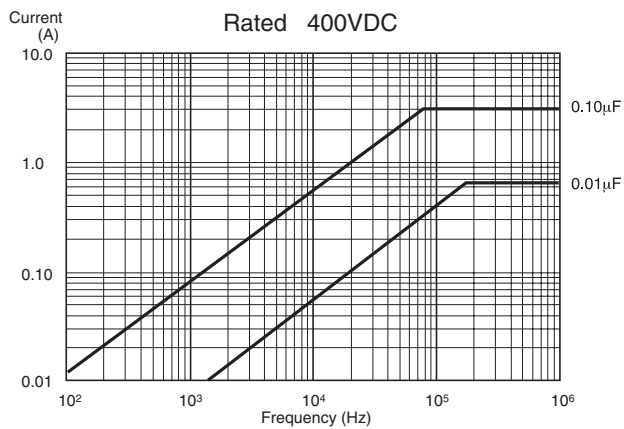
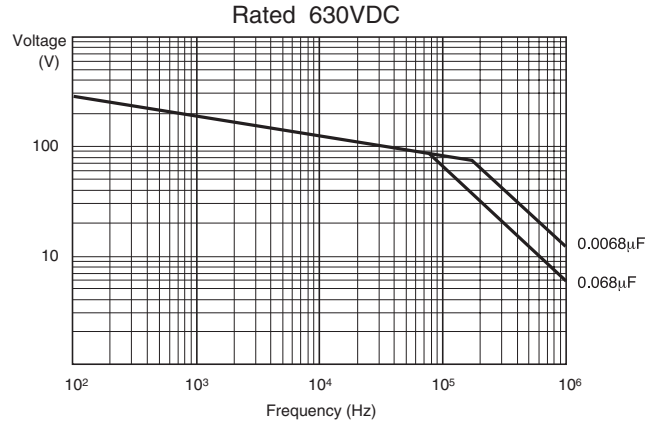
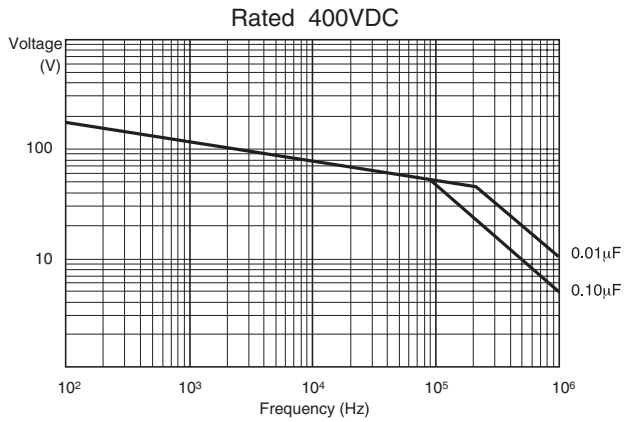

Typical Characteristic Curves Remarks : Typical curves are as shown below. (Slightly different depending on individual rating.)

■ **Temperature Characteristics**

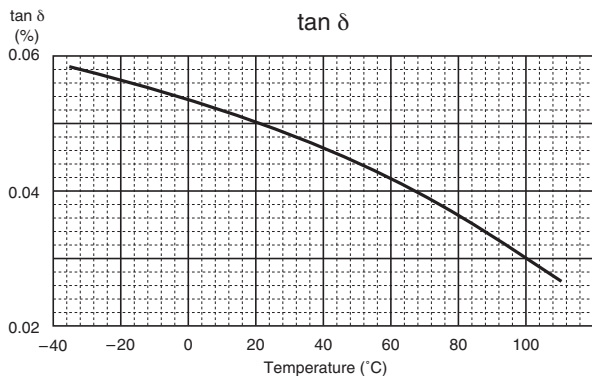
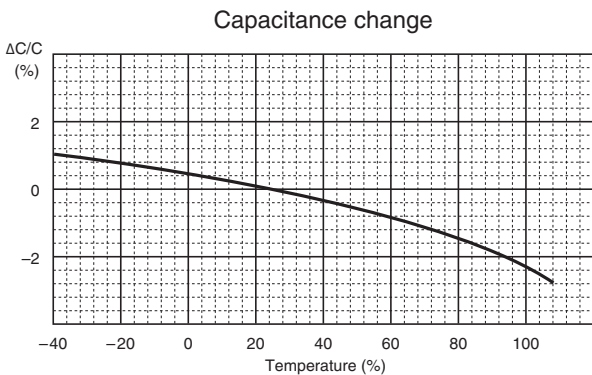

■ **Frequency Characteristics**

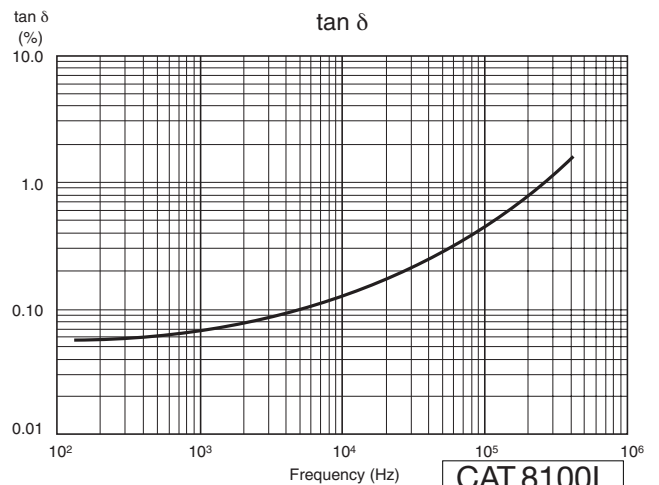
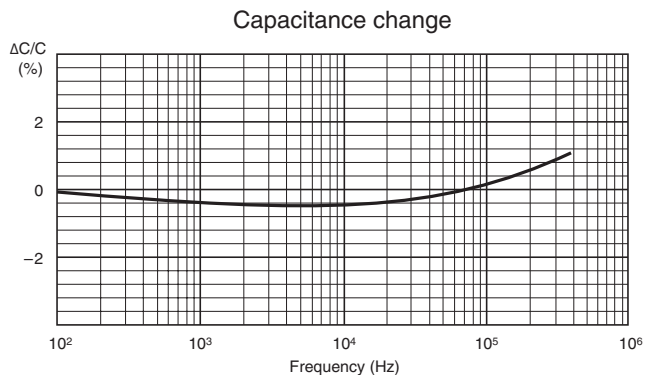

QXL

Metallized Polyester Film Capacitor

for 105°C (Electrical Appliance and Material Safety Law (Japan) approved for AC power source)

- Highly reliable and superior in high frequency applications, self-healing and non-inductive construction, using a dielectric of metallized polyester film.
- Finished by inner dipping, with liquid epoxy resin and outer coating with flame-retardant epoxy resin, those double coatings provide excellent humidity resistance.
- Designed in a small and compact size, but yet with higher capacitance, for high density mounting.
- Compliant to the RoHS directive (2011/65/EU,(EU)2015/863).

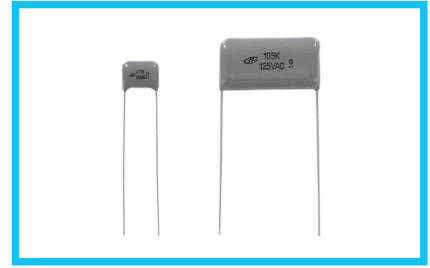

Specifications

Item	Performance Characteristics
Category Temperature Range	-40 to +105°C
Rated Voltage	125, 250VAC
Rated Capacitance Range	Safety performance A1 0.01 to 0.47µF ※ Safety performance C1 0.1 to 1.0µF
Capacitance Tolerance	±10% (K)
Dielectric Loss Tangent	0.8% or less (at 1kHz 20°C)
Insulation Resistance	C ≤ 0.47µF 2000 MΩ or more C > 0.47µF 1000 ΩF or more
Withstand Voltage	Between Terminals : Rated Voltage × 2.3VAC 1min. (Safety performance : A1) Rated Voltage × 1.75VAC 1 min. (Safety performance : C1) Between Terminals Coverage : (Rated Voltage 125VAC) 1000VAC 1 min. (Rated Voltage 250VAC) 1500VAC 1 min.
Encapsulation	Flame-retardant epoxy resin

Type numbering system (Example : 250VAC 0.1µF)

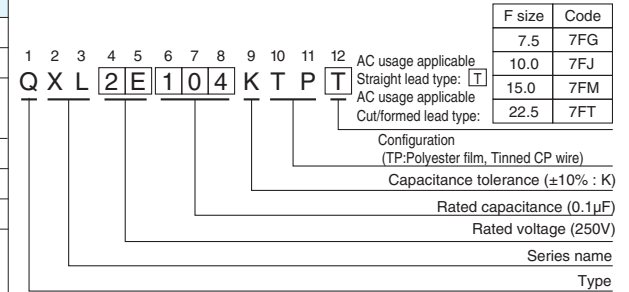

Safety performance

Symbol	A1	C1
	Connected with load in parallel	Connected with load in series
Connecting Condition		
Capacitance	0.01 to 0.47µF ※	0.1 to 1.0µF

Note : When using capacitors as an across-the-line capacitor, at least either one of the conditions shown below has to be fulfilled:

- 1) A varistor of 2 times or below of rated voltage shall be connected with a capacitor in parallel.
- 2) Pulse of higher than rated voltage × 2 shall not be applied to both terminals of capacitor.

Drawing

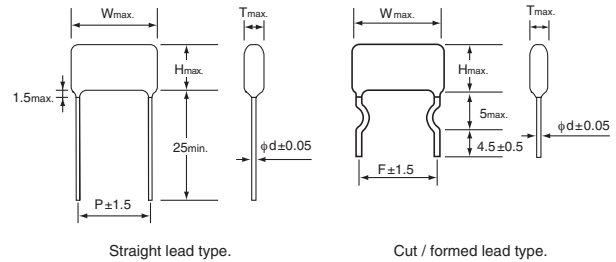

Dimensions

Unit : mm

Cap. (µF)	V(Code)	Code	125VAC (2B)						250VAC (2E)					
			T	W	H	d	P	F	T	W	H	d	P	F
0.01	103								4.4	13.5	9.5	0.6	10.0	10.0
0.015	153								4.7	13.5	9.8	0.6	10.0	10.0
0.022	223		4.3	11.0	7.9	0.6	7.5	7.5	5.1	13.5	10.8	0.6	10.0	10.0
0.033	333		4.6	11.0	8.2	0.6	7.5	7.5	5.9	13.5	11.6	0.6	10.0	10.0
0.047	473		5.1	11.0	8.8	0.6	7.5	7.5	6.4	13.5	13.7	0.6	10.0	10.0
0.068	683		5.8	11.0	9.5	0.6	7.5	7.5	5.8	18.5	11.5	0.6	15.0	15.0
0.1	104		6.8	11.0	10.4	0.6	7.5	7.5	6.4	18.5	13.7	0.6	15.0	15.0
0.15	154		6.5	13.5	11.1	0.6	10.0	10.0	7.1	18.5	15.9	0.6	15.0	15.0
0.22	224		7.6	13.5	12.2	0.6	10.0	10.0	9.6	18.5	15.3	0.6	15.0	15.0
0.33	334		6.7	18.5	11.9	0.6	15.0	15.0	7.9	25.5	16.7	0.8	22.5	22.5
0.47	474		7.7	18.5	12.9	0.6	15.0	15.0	9.4	25.5	18.2	0.8	22.5	22.5
0.68	684		9.1	18.5	14.3	0.6	15.0	15.0						
1.0	105		8.0	25.5	15.3	0.8	22.5	22.5						

F : lead pitch for cut / formed lead wires.

※ In case of safety performance A1, we can also custom-make for 0.47µF or more as well. Please contact us and let us know the specification you need.

QAK

Metallized Polyester Film Capacitor

(Tape-wrapped Axial Compact Type)

- Non-inductive construction, compact size, metallized film capacitor with axial lead wires.
- Highly reliable with self-healing property.
- Minimum loss at high frequency.
- Tape-wrapped and epoxy endfilled at both leads for superior mechanical strength and humidity resistance.
- High capacitance value, offering a wide variety of applications.
- Compliant to the RoHS directive (2011/65/EU,(EU)2015/863).

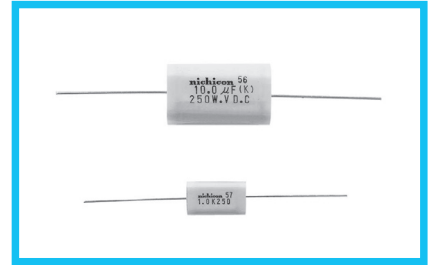

Applications

- Filtering DC-blocking, coupling and so on of general communications equipment and use in AC circuits for motor starting, charging / discharging, lighting, etc.
- Some A.C. applications may cause capacitor failure, over heating of the capacitors and/or discharge may be the result. Please contact us about details for A.C. application.

Products which are scheduled to be discontinued.
Not recommended for new designs.

Specifications

Item	Performance Characteristics
Category Temperature Range	-40 to +85°C
Rated Voltage	250, 400, 630VDC
Rated Capacitance Range	0.1 to 10µF
Capacitance Tolerance	±5% (J), ±10% (K)
Dielectric Loss Tangent	1.0% or less (at 1kHz 20°C)
Insulation Resistance	C ≤ 0.33µF : 9000 MΩ or more C > 0.33µF : 3000 ΩF or more
Withstand Voltage	Between Terminals Rated Voltage × 175%, 1 to 5 secs. Between Terminals and Coverage Rated Voltage × 200%, 1 to 5 secs.
Encapsulation	Adhesive polyester film, epoxy resin

Drawing

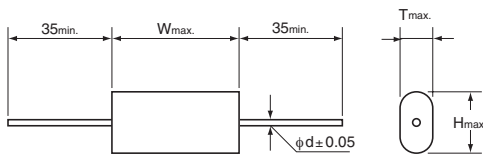

Type numbering system (Example : 250V 1.5µF)

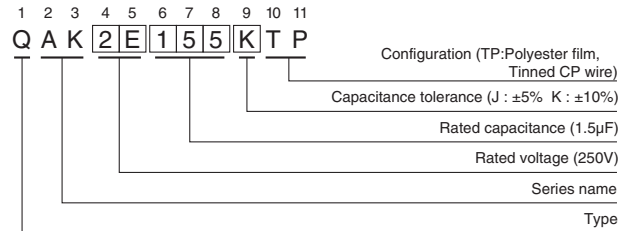

Dimensions

Unit : mm

Cap.(µF)	V(Code) Code	Size	250VDC (2E)				400VDC (2G)				630VDC (2J)			
			T	W	H	d	T	W	H	d	T	W	H	d
0.1	104										6.0	30.0	12.5	0.8
0.15	154										7.5	30.0	14.0	0.8
0.22	224										8.5	30.0	16.5	0.8
0.33	334										10.5	30.0	18.5	0.8
0.47	474		5.5	25.0	12.0	0.8	7.5	25.0	15.5	0.8	9.0	25.0	17.0	0.8
0.68	684		7.0	25.0	13.0	0.8	9.0	30.0	17.0	0.8	11.0	35.0	19.0	0.8
1.0	105		7.5	25.0	15.5	0.8	9.0	30.0	17.0	0.8	11.5	40.0	21.0	1.0
1.5	155		8.0	30.0	16.0	0.8	11.0	30.0	19.0	0.8	12.5	46.0	22.0	1.0
2.2	225		8.0	30.0	16.0	0.8	13.0	30.0	22.5	0.8	16.0	46.0	25.0	1.0
3.3	335		9.5	30.0	17.5	0.8	13.5	35.0	23.0	0.8	18.0	52.0	27.5	1.0
4.7	475		9.5	35.0	19.5	0.8	17.0	35.0	26.5	0.8	22.5	52.0	31.5	1.0
6.8	685		12.0	35.0	21.5	0.8								
10.0	106		13.5	40.0	22.5	1.0								
			16.5	40.0	25.5	1.0								

QAP

Metallized Polypropylene Film Capacitor

(Tape-wrapped Axial Type for High Frequency Applications)



- Non-inductive construction, with axial lead wires.
- Superior performance in high frequency circuit and charging / discharging circuit due to excellent characteristics of metallized polypropylene film dielectric.
- Highly reliable with self-healing property.
- Tape-wrapped and epoxy endfilled at both leads for superior mechanical strength and humidity resistance.
- Some A.C. applications may cause capacitor failure, over heating of the capacitors and / or discharge may be the result. Please contact us about details for A.C. application.
- Compliant to the RoHS directive (2011/65/EU,(EU)2015/863).

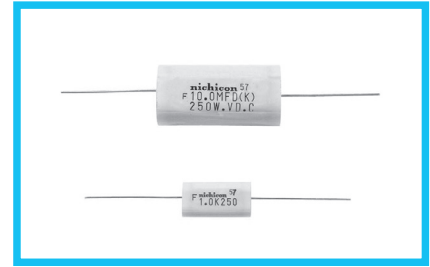

Products which are scheduled to be discontinued.
Not recommended for new designs.

Specifications

Item	Performance Characteristics
Category Temperature Range	-40 to +85°C
Rated Voltage	250, 400, 630VDC
Rated Capacitance Range	0.15 to 10μF
Capacitance Tolerance	±5% (J), ±10% (K)
Dielectric Loss Tangent	0.1% or less (at 1kHz 20°C)
Insulation Resistance	C ≤ 0.33μF : 30000 MΩ or more C > 0.33μF : 10000 ΩF or more
Withstand Voltage	Between Terminals : Rated Voltage × 175%, 1 to 5 secs. Between Terminals and Coverage : Rated Voltage × 200%, 1 to 5 secs.
Encapsulation	Adhesive polyester film, resin

Drawing

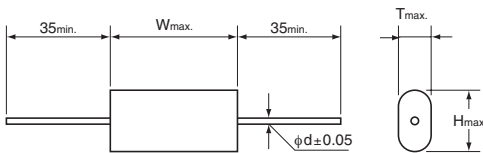

Type numbering system (Example : 250V 1.5μF)

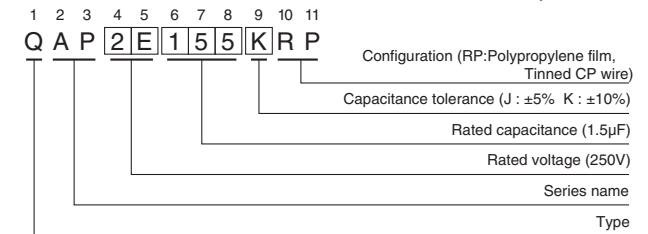

Dimensions

Unit : mm

Cap.(μF)	V(Code) Code	Size	250VDC (2E)				400VDC (2G)				630VDC (2J)			
			T	W	H	d	T	W	H	d	T	W	H	d
0.15	154													
0.22	224													
0.33	334					7.6	30.0	14.2	0.8	8.9	30.0	17.1	0.8	
0.47	474		5.8	30.0	12.4	0.8	9.2	30.0	15.7	0.8	9.3	35.0	17.4	0.8
0.68	684		6.5	30.0	14.7	0.8	10.5	30.0	18.7	0.8	11.4	35.0	19.6	0.8
1.0	105		8.0	30.0	16.2	0.8	11.2	35.0	19.4	0.8	11.9	40.0	21.6	1.0
1.5	155		10.1	30.0	18.2	0.8	13.4	35.0	23.1	0.8	13.5	46.0	23.2	1.0
2.2	225		10.8	35.0	19.0	0.8	14.8	40.0	24.2	1.0	16.8	46.0	26.5	1.0
3.3	335		12.9	35.0	22.6	0.8	16.9	46.0	26.6	1.0	19.4	52.0	29.1	1.0
4.7	475		14.1	40.0	23.8	1.0	19.0	52.0	28.7	1.0				
6.8	685		15.8	46.0	25.5	1.0								
10.0	106		18.1	52.0	27.8	1.0								

QYX Foil Type Polyester Film Capacitor (Standard type)

- Inductive construction, using a dielectric of polyester film together with aluminum foil.
- Coated with epoxy resin for superior heat resistance, humidity resistance and solvent resistance.
- Suited for use in commercial and industrial applications.
- Available for automatic insertion systems.
- Compliant to the RoHS directive (2011/65/EU,(EU)2015/863).

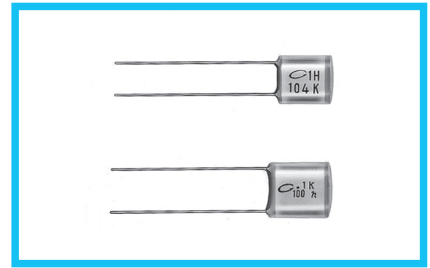

Products which are scheduled to be discontinued.
Not recommended for new designs.

Specifications

Item	Performance Characteristics
Category Temperature Range	-40 to +85°C
Rated Voltage	50, 100VDC
Rated Capacitance Range	0.001 to 0.47μF
Capacitance Tolerance	± 5% (J), ± 10% (K)
Dielectric Loss Tangent	0.8% or less (at 1kHz 20°C)
Insulation Resistance	30000 MΩ or more
Withstand Voltage	Between Terminals : Rated Voltage × 250%, 1 to 5 secs. Between Terminals and Coverage : Rated Voltage × 200%, 1 to 5 secs.
Encapsulation	Epoxy resin

Drawing

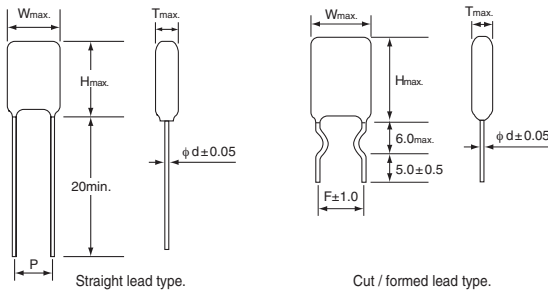

Type numbering system (Example : 50V 0.047μF)

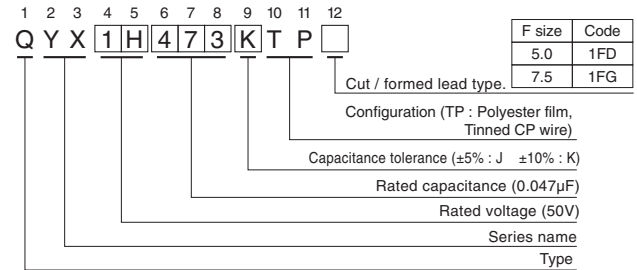

Dimensions

V (Code) Cap. (μF) / Code		50VDC (1H)						100VDC (2A)						Unit : mm
		T	W	H	d	P	F	T	W	H	d	P	F	
0.001	102	2.5	5.0	8.5	0.5	3.5 ± 0.75	5.0	2.8	5.5	11.5	0.5	3.5 ^{+1.0} _{-1.2}	5.0	
0.0015	152	2.5	5.0	8.5	0.5	3.5 ± 0.75	5.0	2.8	5.5	12.0	0.5	3.5 ^{+1.0} _{-1.2}	5.0	
0.0022	222	3.0	5.5	8.5	0.5	3.5 ± 0.75	5.0	2.8	5.5	12.0	0.5	3.5 ^{+1.0} _{-1.2}	5.0	
0.0033	332	3.0	5.5	8.5	0.5	3.5 ± 0.75	5.0	2.8	5.5	12.0	0.5	3.5 ^{+1.0} _{-1.2}	5.0	
0.0047	472	3.0	6.0	8.5	0.5	3.5 ± 0.75	5.0	3.0	6.0	12.0	0.5	3.5 ^{+1.0} _{-1.2}	5.0	
0.0068	682	3.5	6.0	8.5	0.5	3.5 ± 0.75	5.0	3.0	6.0	12.0	0.5	5.0 ± 1.0	5.0	
0.01	103	3.5	6.0	8.5	0.5	3.5 ± 0.75	5.0	3.0	6.5	12.0	0.5	5.0 ± 1.0	5.0	
0.015	153	3.5	6.0	10.0	0.5	3.5 ± 0.75	5.0	3.0	6.5	13.0	0.5	5.0 ± 1.0	5.0	
0.022	223	3.5	6.5	10.5	0.5	3.5 ± 0.75	5.0	3.5	7.0	13.0	0.5	5.0 ± 1.0	5.0	
0.033	333	4.0	7.0	10.5	0.5	3.5 ± 0.75	5.0	3.5	7.5	13.0	0.5	5.0 ± 1.0	5.0	
0.047	473	4.5	7.5	11.0	0.5	5.0 ± 1.0	5.0	4.5	8.5	14.0	0.5	5.0 ± 1.0	5.0	
0.068	683	5.0	8.0	11.0	0.5	5.0 ± 1.0	5.0	4.5	9.5	14.0	0.5	7.5 ^{+1.0} _{-1.2}	7.5	
0.1	104	5.5	9.0	12.0	0.5	5.0 ± 1.0	5.0	5.5	11.0	14.0	0.5	7.5 ^{+1.0} _{-1.2}	7.5	
0.15	154	6.5	10.0	13.5	0.5	5.0 ± 1.0	5.0	6.0	12.5	15.5	0.5	10.0 ^{+1.0} _{-1.2}	7.5	
0.22	224	7.0	11.0	13.5	0.5	7.5 ^{+1.0} _{-1.2}	7.5	7.0	14.0	15.5	0.5	10.0 ^{+1.0} _{-1.2}	7.5	
0.33	334	8.0	12.5	16.0	0.6	7.5 ^{+1.0} _{-1.2}	7.5	8.0	14.5	18.5	0.6	10.0 ^{+1.0} _{-1.2}	7.5	
0.47	474	9.5	14.0	16.5	0.6	7.5 ^{+1.0} _{-1.2}	7.5	9.5	16.5	18.5	0.6	10.0 ^{+1.0} _{-1.2}	7.5	

F : lead pitch for cut / formed lead wires.



Metallized Polypropylene Film AC Power Capacitor

- Compliant to the RoHS directive (2011/65/EU,(EU)2015/863).

Products which are scheduled to be discontinued.
Not recommended for new designs.

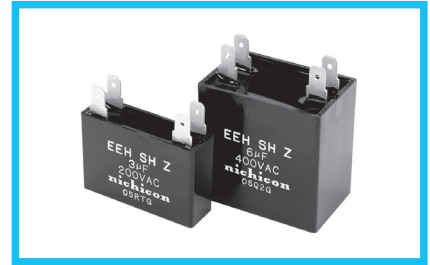

Specifications

Item	Performance Characteristics
Maximum permissible temperature	+85°C (Z)
Minimum ambient temperature	-25°C (B)
Rated Voltage Range	200 to 400VAC
Rated Capacitance Range	1.0 to 50µF
Capacitance Tolerance	+10 to -5%
Dielectric Loss Tangent	0.12% or less (at 20°C, 50 / 60Hz 200VAC)
Withstand Voltage	Between Terminals : Rated Voltage (VAC) × 175% 10secs. Between Terminals connected together and case : 2000VAC 60secs.
Insulation Resistance	Between Terminals connected together and case : 1000 MΩ or more (at 500VDC)
Encapsulation	Flame-retardant epoxy cased, Resin filled
Current duration class	40D (40,000h)
Safety Mechanism	Non-included

Drawing

Please refer to the next page.

Dimensions

Unit : mm

(µF) Cap.	V (Code) Size Code	200VAC (2D)				250VAC (2E)				400VAC (2G)			
		A	B	C	Fig.	A	B	C	Fig.	A	B	C	Fig.
1.0	105	-	-	-	① ③ ⑤	-	-	-	① ③ ⑤	37.0	11.5	25.0	① ③ ⑤
1.5	155	-	-	-		37.0	11.5	25.0		37.0	11.5	25.0	
2.0	205	37.0	11.5	25.0		37.0	11.5	25.0		37.0	13.5	27.0	
2.5	255	37.0	11.5	25.0		37.0	11.5	25.0		37.0	15.5	29.0	
3.0	305	37.0	11.5	25.0		37.0	11.5	25.0		37.0	15.5	29.0	
3.5	355	37.0	11.5	25.0		37.0	11.5	25.0		37.0	17.5	31.0	
4.0	405	37.0	11.5	25.0		37.0	11.5	25.0		37.0	19.5	33.0	
4.5	455	37.0	13.5	27.0		37.0	13.5	27.0		37.0	19.5	33.0	
5.0	505	37.0	13.5	27.0		37.0	13.5	27.0		37.0	21.5	35.0	
6.0	605	37.0	13.5	27.0		37.0	13.5	27.0		37.0	24.0	37.0	
7.0	705	37.0	15.5	29.0	37.0	15.5	29.0	37.0	24.0	37.0			
8.0	805	37.0	17.5	31.0	37.0	17.5	31.0	58.0	26.0	40.0	② ④		
10.0	106	37.0	19.5	33.0	37.0	19.5	33.0	58.0	26.0	40.0			
12.0	126	37.0	21.5	35.0	37.0	21.5	35.0	58.0	26.0	40.0			
14.0	146	37.0	24.0	37.0	37.0	24.0	37.0	58.0	30.0	44.0			
15.0	156	37.0	24.0	37.0	37.0	24.0	37.0	58.0	30.0	44.0			
16.0	166	37.0	24.0	37.0	37.0	24.0	37.0	58.0	30.0	44.0			
18.0	186	58.0	26.0	40.0	58.0	26.0	40.0	58.0	30.0	44.0			
20.0	206	58.0	26.0	40.0	58.0	26.0	40.0	58.0	34.0	49.0			
22.0	226	58.0	26.0	40.0	58.0	26.0	40.0						
25.0	256	58.0	26.0	40.0	58.0	26.0	40.0						
30.0	306	58.0	26.0	40.0	58.0	26.0	40.0						
40.0	406	58.0	30.0	44.0	58.0	30.0	44.0						
50.0	506	58.0	34.0	49.0	58.0	34.0	49.0						

EEC

■ Drawing

- Tab terminal 2 (Terminal shape : **Q**)

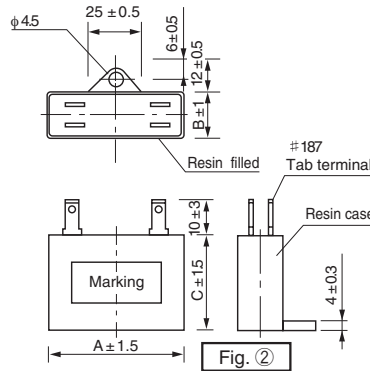
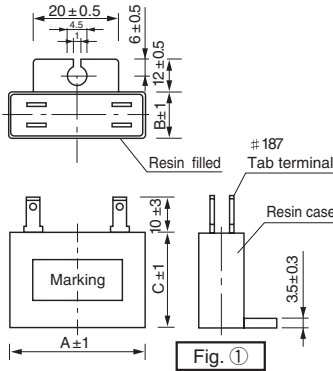

- Tab terminal 1 (Terminal shape : **Z**)

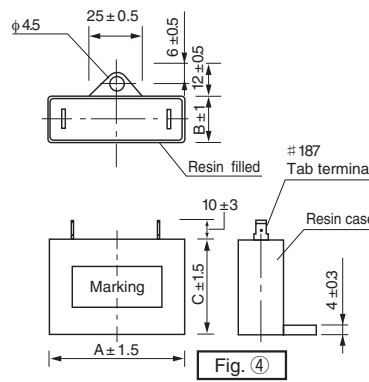
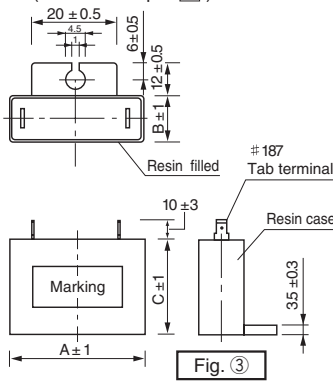

- Pin terminal (Terminal shape : **W**)

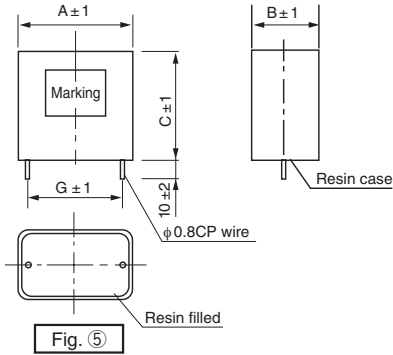

Remarks : 1) Dimension of case bottom is expressed by A and B.
2) Dimension B of case top shall be ± 1.0mm as shown below.

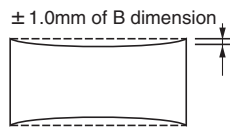

3) In case of pin terminal product, cased dimension A is only 37mm.

■ Dimensions

Case size (mm)			Case size code () for Pin terminal	Terminal Shape Q	Terminal Shape Z	Terminal Shape W	
A	B	C		Fig	Fig	Lead pitch G (mm)	Fig
37.0	11.5	25.0	01	①	③	34.2	⑤
37.0	13.5	27.0*	02 (09)*				
37.0	15.5	29.0	03 (27)**				
37.0	17.5	31.0	04 (11)***				
37.0	19.5	33.0	05				
37.0	21.5	35.0	06				
37.0	24.0	37.0	07				
58.0	26.0	40.0	15	②	④	—	—
58.0	30.0	44.0	16				
58.0	34.0	49.0	31				

* In case of pin terminal dimension will be 37.0 × 13.5 × 28.0mm. (Code : **09**)
 ** In case of pin terminal dimension will be 37.0 × 15.5 × 29.0mm. (Code : **27**)
 *** In case of pin terminal dimension will be 37.0 × 17.5 × 31.0mm. (Code : **11**)

EXH

Metallized Polypropylene Film AC Power Capacitor

- Self-healing and non-inductive wound by metallized film, with flame-retardant epoxy resin coating for humidity resistance.
- Compliant to the RoHS directive (2011/65/EU,(EU)2015/863).

Application

- Motor running

Products which are scheduled to be discontinued.
Not recommended for new designs.

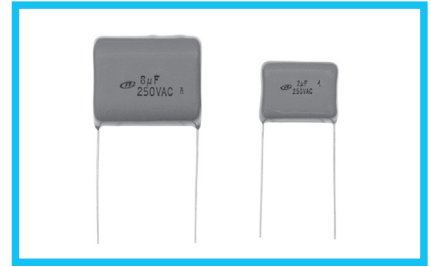

Specifications

Item	Performance Characteristics
Maximum permissible temperature	+85°C (Z)
Minimum ambient temperature	- 25°C (B)
Rated Voltage Range	250VAC
Rated Capacitance Range	6 to 12µF
Capacitance Tolerance	+10 to -5%
Loss factor	0.12% or less (at 20°C 50/60Hz 200VAC)
Withstand Voltage	Between Terminals : Rated Voltage x 175% 10 secs. Between Terminals connected together and case : 2000VAC 60 secs.
Insulation Resistance	Between Terminals connected together and case : 1000MΩ or more (at 500VDC)
Encapsulation	Flame retardant epoxy resin
Current duration class	40D (40,000h)
Safety Mechanism	Non-included

Type numbering system (Example : 250VAC 6µF)

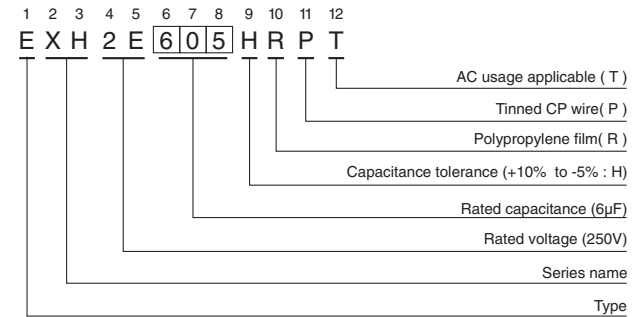

Drawing

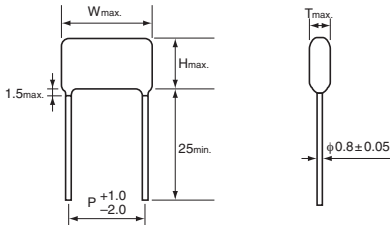

Straight lead type

Dimensions

Unit : mm

Cap. (µF)	Code	V (Code) Size	250VAC (2E)			
			T	W	H	P
6.0	605		14.0	36.0	25.5	32.5
7.0	705		14.5	36.0	27.5	32.5
8.0	805		15.5	36.0	28.5	32.5
9.0	905		16.5	36.0	29.5	32.5
10.0	106		17.5	36.0	30.5	32.5
12.0	126		18.5	36.0	31.5	32.5

Since rating other than the above can be manufactured a please ask for detail.