



Test Report issued under the responsibility of:



**TEST REPORT**  
**IEC 62368-1**  
**Audio/video, information and communication technology equipment**  
**Part 1: Safety requirements**

**Report Number** ..... : 60431427 001  
**Date of issue** ..... : 2020-12-22  
**Total number of pages** ..... : 79

**Applicant's name** ..... : Inventus Power, Inc.-Technical Center  
**Address** ..... : 5th Floor western, Changhua Building, No.921 Xingye Road, Nancun Town, Panyu Guangzhou, 511442 Guangdong, P. R. China

**Test specification:**  
**Standard**..... : IEC 62368-1:2014 (Second Edition)  
**Test procedure**..... : CB Scheme  
**Non-standard test method** ..... : N/A

**Test Report Form No.** ..... : IEC62368\_1B  
**Test Report Form(s) Originator**..... : UL (US)  
**Master TRF** ..... : 2014-03

**Copyright © 2014 Worldwide System for Conformity Testing and Certification of Electrotechnical Equipment and Components (IECEE), Geneva, Switzerland. All rights reserved.**  
 This publication may be reproduced in whole or in part for non-commercial purposes as long as the IECEE is acknowledged as copyright owner and source of the material. IECEE takes no responsibility for and will not assume liability for damages resulting from the reader's interpretation of the reproduced material due to its placement and context.  
 If this Test Report Form is used by non-IECEE members, the IECEE/IEC logo and the reference to the CB Scheme procedure shall be removed.  
**This report is not valid as a CB Test Report unless signed by an approved CB Testing Laboratory and appended to a CB Test Certificate issued by an NCB in accordance with IECEE 02.**

**General disclaimer:**  
 The test results presented in this report relate only to the object tested.  
 This report shall not be reproduced, except in full, without the written approval of the Issuing CB Testing Laboratory. The authenticity of this Test Report and its contents can be verified by contacting the NCB, responsible for this Test Report.

|                             |   |
|-----------------------------|---|
| Test Item description ..... | Power Supply  |
| Trade Mark .....            | <p>1)  , 2)  ,<br/>         3)  , 4) EGSTON</p>                               |
| Manufacturer .....          | Inventus Power, Inc.<br>1200 Internationale Parkway, Woodridge, IL 60517, USA |
| Model/Type reference .....  | FWE0x0yBz, MWA0x0yBz (x, y, z are variables, details see                      |

|               |   |
|---------------|---|
|               | model list on pages 8-9).   |
| Ratings ..... | Input: AC 100-240 V, 50-60 Hz, 1.5A Max..<br>Output: See model list on pages 8-9. |

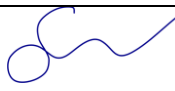
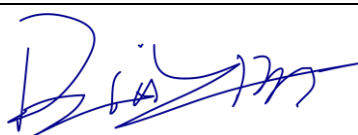
|   |  |  |
|---|--|--|
| Testing procedure and testing location:       |  |  |
| <input checked="" type="checkbox"/>           | <b>CB Testing Laboratory:</b>                  | <b>TÜV Rheinland (Guangdong) Ltd.</b>  |
| <b>Testing location/ address .....</b>        |  | No.199 Kezhu Road, Guangzhou Science City 510663<br>Guangzhou, China   |
| <input type="checkbox"/>                      | <b>Associated CB Testing Laboratory:</b>       |  |
| <b>Testing location/ address .....</b>        |  |  |
| <b>Tested by (name + signature).....:</b>     |  | Spark Li<br>Project Engineer  |
| <b>Approved by (name + signature) .....</b>   |  | Ben Zeng<br>Reviewer          |
|   |  |  |
| <input type="checkbox"/>                      | <b>Testing procedure: TMP/CTF Stage 1</b>      |  |
| <b>Testing location/ address .....</b>        |  |  |
| <b>Tested by (name + signature).....:</b>     |  |  |
| <b>Approved by (name + signature) .....</b>   |  |  |
|   |  |  |
| <input type="checkbox"/>                      | <b>Testing procedure: WMT/CTF Stage 2</b>      |  |
| <b>Testing location/ address .....</b>        |  |  |
| <b>Tested by (name + signature).....:</b>     |  |  |
| <b>Witnessed by (name + signature) .....</b>  |  |  |
| <b>Approved by (name + signature) .....</b>   |  |  |
|   |  |  |
| <input type="checkbox"/>                      | <b>Testing procedure: SMT/CTF Stage 3 or 4</b> |  |
| <b>Testing location/ address .....</b>        |  |  |
| <b>Tested by (name + signature).....:</b>     |  |  |
| <b>Approved by (name + signature) .....</b>   |  |  |
| <b>Supervised by (name + signature).....:</b> |  |  |

|  |  |  |                            |  |         |                                  |       |            |       |                       |       |                        |         |                                |       |   |          |  |       |             |     |  |     |                                   |       |   |         |                        |         |                      |     |                         |     |                          |     |                         |     |             |     |                    |   |
|--|--|--|----------------------------|--|---------|----------------------------------|-------|------------|-------|-----------------------|-------|------------------------|---------|--------------------------------|-------|---|----------|--|-------|-------------|-----|--|-----|-----------------------------------|-------|---|---------|------------------------|---------|----------------------|-----|-------------------------|-----|--------------------------|-----|-------------------------|-----|-------------|-----|--------------------|---|
| <p><b>List of Attachments (including a total number of pages in each attachment):</b></p> <ul style="list-style-type: none"> <li>- Attachment 1: National Differences (37 pages)</li> <li>- Attachment 2: National Special Requirement (13 pages)</li> <li>- Attachment 3: Photo documentation (13 pages)</li> </ul>   |  |  |                            |  |         |                                  |       |            |       |                       |       |                        |         |                                |       |   |          |  |       |             |     |  |     |                                   |       |   |         |                        |         |                      |     |                         |     |                          |     |                         |     |             |     |                    |   |
| <p><b>Summary of testing:</b></p>  |  |  |                            |  |         |                                  |       |            |       |                       |       |                        |         |                                |       |   |          |  |       |             |     |  |     |                                   |       |   |         |                        |         |                      |     |                         |     |                          |     |                         |     |             |     |                    |   |
| <p><b>Tests performed (name of test and test clause):</b><br/>All applicable tests as described in test case and measurement sections were performed.</p> <table border="1"> <tr><td>5.2</td><td>Electrical energy source classifications</td></tr> <tr><td>5.4.1.4, 6.3.2, 9.0, B.2.6</td><td>Maximum operating temperatures for materials, components and systems</td></tr> <tr><td>5.4.1.8</td><td>Determination of working voltage</td></tr> <tr><td>5.4.5</td><td>Surge test</td></tr> <tr><td>5.4.8</td><td>Humidity conditioning</td></tr> <tr><td>5.4.9</td><td>Electric strength test</td></tr> <tr><td>5.5.2.2</td><td>Stored discharge on capacitors</td></tr> <tr><td>6.2.2</td><td>Electrical power sources (PS) measurements for classification</td></tr> <tr><td>6.3, 6.4</td><td>Simulated abnormal operating and single fault conditions</td></tr> <tr><td>B.2.5</td><td>Input tests</td></tr> <tr><td>B.3</td><td>Simulated Abnormal operating condition tests</td></tr> <tr><td>B.4</td><td>Simulated single fault conditions</td></tr> <tr><td>F.3.9</td><td>Durability, legibility and permanence of markings</td></tr> <tr><td>G.5.3.2</td><td>Transformer insulation</td></tr> <tr><td>G.5.3.3</td><td>Transformer overload</td></tr> <tr><td>T.2</td><td>Steady force test, 10 N</td></tr> <tr><td>T.4</td><td>Steady force test, 100 N</td></tr> <tr><td>T.5</td><td>Steady force test. 250N</td></tr> <tr><td>T.6</td><td>Impact test</td></tr> <tr><td>T.8</td><td>Stress relief test</td></tr> </table> <p>Remark:<br/>The models FWE050012B, FWE050024B have been selected for multiple testing. If no specified, the mode FWE050024B was the selected model for the tests.</p> | 5.2  | Electrical energy source classifications | 5.4.1.4, 6.3.2, 9.0, B.2.6 | Maximum operating temperatures for materials, components and systems | 5.4.1.8 | Determination of working voltage | 5.4.5 | Surge test | 5.4.8 | Humidity conditioning | 5.4.9 | Electric strength test | 5.5.2.2 | Stored discharge on capacitors | 6.2.2 | Electrical power sources (PS) measurements for classification | 6.3, 6.4 | Simulated abnormal operating and single fault conditions | B.2.5 | Input tests | B.3 | Simulated Abnormal operating condition tests | B.4 | Simulated single fault conditions | F.3.9 | Durability, legibility and permanence of markings | G.5.3.2 | Transformer insulation | G.5.3.3 | Transformer overload | T.2 | Steady force test, 10 N | T.4 | Steady force test, 100 N | T.5 | Steady force test. 250N | T.6 | Impact test | T.8 | Stress relief test | <p><b>Testing location:</b><br/><b>TÜV Rheinland (Guangdong) Ltd.</b><br/>No.199 Kezhu Road, Guangzhou Science City 510663 Guangzhou, China</p> |
| 5.2  | Electrical energy source classifications                             |  |                            |  |         |                                  |       |            |       |                       |       |                        |         |                                |       |   |          |  |       |             |     |  |     |                                   |       |   |         |                        |         |                      |     |                         |     |                          |     |                         |     |             |     |                    |   |
| 5.4.1.4, 6.3.2, 9.0, B.2.6   | Maximum operating temperatures for materials, components and systems |  |                            |  |         |                                  |       |            |       |                       |       |                        |         |                                |       |   |          |  |       |             |     |  |     |                                   |       |   |         |                        |         |                      |     |                         |     |                          |     |                         |     |             |     |                    |   |
| 5.4.1.8  | Determination of working voltage                                     |  |                            |  |         |                                  |       |            |       |                       |       |                        |         |                                |       |   |          |  |       |             |     |  |     |                                   |       |   |         |                        |         |                      |     |                         |     |                          |     |                         |     |             |     |                    |   |
| 5.4.5  | Surge test   |  |                            |  |         |                                  |       |            |       |                       |       |                        |         |                                |       |   |          |  |       |             |     |  |     |                                   |       |   |         |                        |         |                      |     |                         |     |                          |     |                         |     |             |     |                    |   |
| 5.4.8  | Humidity conditioning  |  |                            |  |         |                                  |       |            |       |                       |       |                        |         |                                |       |   |          |  |       |             |     |  |     |                                   |       |   |         |                        |         |                      |     |                         |     |                          |     |                         |     |             |     |                    |   |
| 5.4.9  | Electric strength test   |  |                            |  |         |                                  |       |            |       |                       |       |                        |         |                                |       |   |          |  |       |             |     |  |     |                                   |       |   |         |                        |         |                      |     |                         |     |                          |     |                         |     |             |     |                    |   |
| 5.5.2.2  | Stored discharge on capacitors                                       |  |                            |  |         |                                  |       |            |       |                       |       |                        |         |                                |       |   |          |  |       |             |     |  |     |                                   |       |   |         |                        |         |                      |     |                         |     |                          |     |                         |     |             |     |                    |   |
| 6.2.2  | Electrical power sources (PS) measurements for classification        |  |                            |  |         |                                  |       |            |       |                       |       |                        |         |                                |       |   |          |  |       |             |     |  |     |                                   |       |   |         |                        |         |                      |     |                         |     |                          |     |                         |     |             |     |                    |   |
| 6.3, 6.4   | Simulated abnormal operating and single fault conditions             |  |                            |  |         |                                  |       |            |       |                       |       |                        |         |                                |       |   |          |  |       |             |     |  |     |                                   |       |   |         |                        |         |                      |     |                         |     |                          |     |                         |     |             |     |                    |   |
| B.2.5  | Input tests  |  |                            |  |         |                                  |       |            |       |                       |       |                        |         |                                |       |   |          |  |       |             |     |  |     |                                   |       |   |         |                        |         |                      |     |                         |     |                          |     |                         |     |             |     |                    |   |
| B.3  | Simulated Abnormal operating condition tests                         |  |                            |  |         |                                  |       |            |       |                       |       |                        |         |                                |       |   |          |  |       |             |     |  |     |                                   |       |   |         |                        |         |                      |     |                         |     |                          |     |                         |     |             |     |                    |   |
| B.4  | Simulated single fault conditions                                    |  |                            |  |         |                                  |       |            |       |                       |       |                        |         |                                |       |   |          |  |       |             |     |  |     |                                   |       |   |         |                        |         |                      |     |                         |     |                          |     |                         |     |             |     |                    |   |
| F.3.9  | Durability, legibility and permanence of markings                    |  |                            |  |         |                                  |       |            |       |                       |       |                        |         |                                |       |   |          |  |       |             |     |  |     |                                   |       |   |         |                        |         |                      |     |                         |     |                          |     |                         |     |             |     |                    |   |
| G.5.3.2  | Transformer insulation   |  |                            |  |         |                                  |       |            |       |                       |       |                        |         |                                |       |   |          |  |       |             |     |  |     |                                   |       |   |         |                        |         |                      |     |                         |     |                          |     |                         |     |             |     |                    |   |
| G.5.3.3  | Transformer overload   |  |                            |  |         |                                  |       |            |       |                       |       |                        |         |                                |       |   |          |  |       |             |     |  |     |                                   |       |   |         |                        |         |                      |     |                         |     |                          |     |                         |     |             |     |                    |   |
| T.2  | Steady force test, 10 N  |  |                            |  |         |                                  |       |            |       |                       |       |                        |         |                                |       |   |          |  |       |             |     |  |     |                                   |       |   |         |                        |         |                      |     |                         |     |                          |     |                         |     |             |     |                    |   |
| T.4  | Steady force test, 100 N   |  |                            |  |         |                                  |       |            |       |                       |       |                        |         |                                |       |   |          |  |       |             |     |  |     |                                   |       |   |         |                        |         |                      |     |                         |     |                          |     |                         |     |             |     |                    |   |
| T.5  | Steady force test. 250N  |  |                            |  |         |                                  |       |            |       |                       |       |                        |         |                                |       |   |          |  |       |             |     |  |     |                                   |       |   |         |                        |         |                      |     |                         |     |                          |     |                         |     |             |     |                    |   |
| T.6  | Impact test  |  |                            |  |         |                                  |       |            |       |                       |       |                        |         |                                |       |   |          |  |       |             |     |  |     |                                   |       |   |         |                        |         |                      |     |                         |     |                          |     |                         |     |             |     |                    |   |
| T.8  | Stress relief test   |  |                            |  |         |                                  |       |            |       |                       |       |                        |         |                                |       |   |          |  |       |             |     |  |     |                                   |       |   |         |                        |         |                      |     |                         |     |                          |     |                         |     |             |     |                    |   |

**Summary of compliance with National Differences:**

List of countries addressed: (According to IEC 62368-1:2014 (Second Edition))

EU Group Differences, EU Special National Conditions

AU, DE, DK, FI, GB, IE, IT, JP, NO, NZ, SE, US

Explanation of used codes: AU=Australia, DE=Germany, DK=Denmark, FI=Finland, GB= United Kingdom, IE=Ireland, IT=Italy, JP=Japan, NO=Norway, NZ=New Zealand, SE=Sweden, US=United States of America.

**Special national requirement: CA.**

Explanation of used codes: CA=Canada

The product fulfils the requirements of IEC 62368-1:2014, EN 62368-1:2014+A11:2017.

**Copy of marking plate(s):**

The artwork below may be only a draft. The use of certification marks on a product must be authorized by the respective NCBs that own these marks.

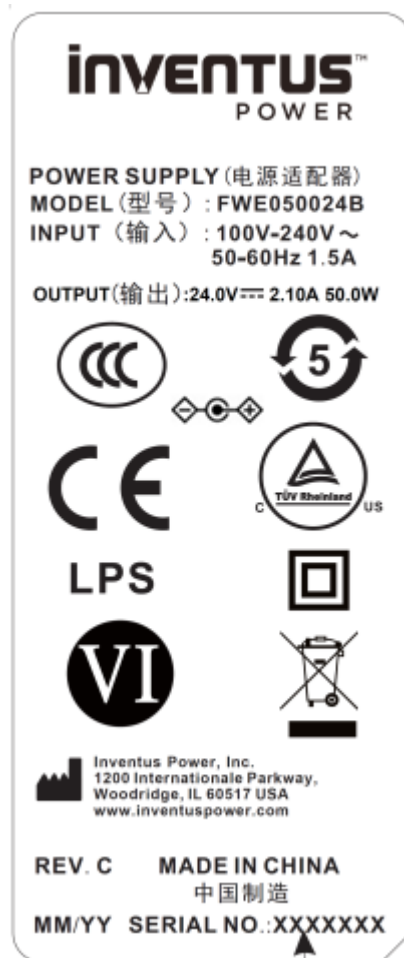
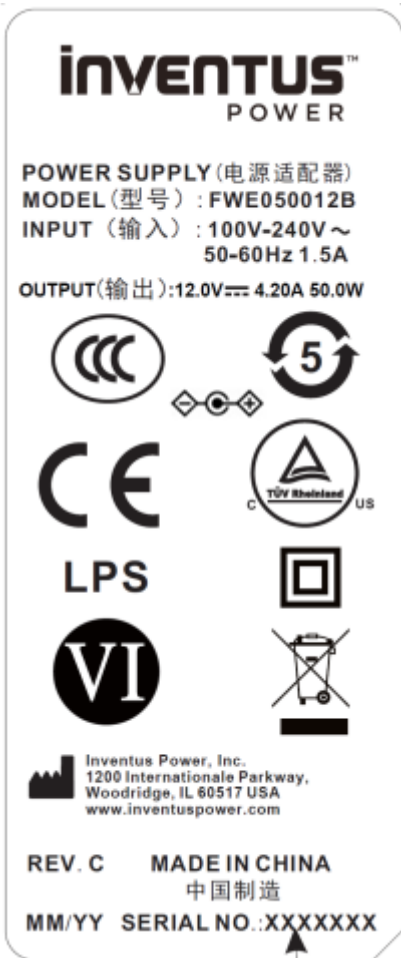

Note:

1. There are representative labels; the others are identical to them except for the model number and output rating.
2. The manufacturer's address and importer's name and address should be provided on label or package or a document accompanying the equipment before the product is placed on the EU market.

| <b>TEST ITEM PARTICULARS:</b>  |   |
|--|---|
| Classification of use by .....   | <input checked="" type="checkbox"/> Ordinary person<br><input type="checkbox"/> Instructed person<br><input type="checkbox"/> Skilled person<br><input checked="" type="checkbox"/> Children likely to be present   |
| Supply Connection.....   | <input checked="" type="checkbox"/> AC Mains <input type="checkbox"/> DC Mains<br><input type="checkbox"/> External Circuit - not Mains connected<br>- <input type="checkbox"/> ES1 <input type="checkbox"/> ES2 <input type="checkbox"/> ES3   |
| Supply % Tolerance .....   | <input checked="" type="checkbox"/> +10%/-10%<br><input type="checkbox"/> +20%/-15%<br><input type="checkbox"/> + ___ % / - ___ %<br><input type="checkbox"/> None  |
| Supply Connection – Type .....   | <input checked="" type="checkbox"/> pluggable equipment type A -<br><input type="checkbox"/> non-detachable supply cord<br><input checked="" type="checkbox"/> appliance coupler<br><input type="checkbox"/> direct plug-in<br><input type="checkbox"/> mating connector<br><input type="checkbox"/> pluggable equipment type B -<br><input type="checkbox"/> non-detachable supply cord<br><input type="checkbox"/> appliance coupler<br><input type="checkbox"/> permanent connection<br><input type="checkbox"/> mating connector<br><input type="checkbox"/> other: _____ |
| Considered current rating of protective device as part of building or equipment installation ..... | 16 A (20A for US and CA, 13A for GB)<br>Installation location: <input checked="" type="checkbox"/> building; <input type="checkbox"/> equipment   |
| Equipment mobility .....   | <input checked="" type="checkbox"/> movable <input type="checkbox"/> hand-held <input checked="" type="checkbox"/> transportable<br><input type="checkbox"/> stationary <input type="checkbox"/> for building-in <input type="checkbox"/> direct plug-in<br><input type="checkbox"/> rack-mounting <input type="checkbox"/> wall-mounted  |
| Over voltage category (OVC) .....  | <input type="checkbox"/> OVC I <input checked="" type="checkbox"/> OVC II <input type="checkbox"/> OVC III<br><input type="checkbox"/> OVC IV <input type="checkbox"/> other: _____   |
| Class of equipment .....   | <input type="checkbox"/> Class I <input checked="" type="checkbox"/> Class II <input type="checkbox"/> Class III  |
| Access location .....  | <input type="checkbox"/> restricted access location <input checked="" type="checkbox"/> N/A   |
| Pollution degree (PD) .....  | <input type="checkbox"/> PD 1 <input checked="" type="checkbox"/> PD 2 <input type="checkbox"/> PD 3  |
| Manufacturer’s specified maximum operating ambient .....   | Full load at 40°C, derated linearly to 50% load at 60°C   |
| IP protection class .....  | <input checked="" type="checkbox"/> IPX0 <input type="checkbox"/> IP___   |
| Power Systems .....  | <input checked="" type="checkbox"/> TN <input type="checkbox"/> TT <input type="checkbox"/> IT - 230 V L-L  |
| Altitude during operation (m) .....  | <input type="checkbox"/> 2000 m or less<br><input checked="" type="checkbox"/> Up to 5000m  |
| Altitude of test laboratory (m) .....  | <input checked="" type="checkbox"/> 2000 m or less <input type="checkbox"/> _____ m   |
| Mass of equipment (kg) .....   | <input checked="" type="checkbox"/> Approx. 0.22kg  |

|  |   |
|--|---|
| <b>POSSIBLE TEST CASE VERDICTS:</b>  |   |
| - test case does not apply to the test object.....:  | N/A   |
| - test object does meet the requirement .....  | P (Pass)  |
| - test object does not meet the requirement .....  | F (Fail)  |
| <b>TESTING:</b>  |   |
| Date of receipt of test item.....:   | 2020-12-11  |
| Date (s) of performance of tests .....   | 2020-12-11 to 2020-12-20  |
| <b>GENERAL REMARKS:</b>  |   |
| "(See Enclosure #)" refers to additional information appended to the report.<br>"(See appended table)" refers to a table appended to the report.<br>Throughout this report a <input type="checkbox"/> comma / <input checked="" type="checkbox"/> point is used as the decimal separator.  |   |
| <b>Manufacturer's Declaration per sub-clause 4.2.5 of IEC62368-1:</b>  |   |
| The application for obtaining a CB Test Certificate includes more than one factory location and a declaration from the Manufacturer stating that the sample(s) submitted for evaluation is (are) representative of the products from each factory has been provided .....:   | <input checked="" type="checkbox"/> <b>Yes</b><br><input type="checkbox"/> <b>Not applicable</b>  |
| <b>When differences exist; they shall be identified in the General product information section.</b>  |   |
| <b>Name and address of factory (ies) .....</b>   | <b>1) ICC Electronics (Dongguan) Ltd.</b><br>No.23, Shang Yuan Road, Qing Xi Town, Dong Guan City, Guangdong, P.R. China<br><b>2) Inventus Power Mexico S.A de C.V</b><br>Calle Guerrero Negro No. 9985 Parque Industrial Pacífico Tijuana Baja California 22643 MEXICO<br><b>3) INVENTUS POWER (MALAYSIA) SDN. BHD.</b><br>PLO 176, Jalan Cyber 7, Kawasan Perindustrian Senai III, 81400 Senai, Johor, Malaysia |
| <b>GENERAL PRODUCT INFORMATION:</b>  |   |
| 1. The equipment models are Class II switching adapter models used for DC supply of Audio/video, information and communication technology equipment, the output cord is non-detachable.<br>2. The power adapter's top enclosure is secured to bottom enclosure by ultrasonic weld.<br>3. Pre-production samples without serial numbers.<br>4. Specified maximum ambient temperature is 60°C (Full load at 40°C, derated linearly to 50% load at 60°C).<br>5. All models were evaluated for a maximum operating altitude of 5000m. Therefore the requirements of IEC 62368-1 for clearances were considered and the required clearance was multiplied with an altitude correction factor of 1.48. |   |
| <b>Difference between models:</b>  |   |
| 1, R3, R4, R17, R21, R23, R24, R29, C9, C6, C4, C5, CY1, Q1, Q2: The parameters of these components depends on output voltage and output current.<br>2, T1: The adaptors with different output voltage have different secondary winding of transformer.<br>3, FWE0x0yBz are identical to MWA0x0yBz, except the model number.   |   |

**Model list:**

FWE0x0yBz, MWA0x0yBz (x, y, z are variable):

| Model   | Input                     | Output        |                  |                | T1 Transformer no. (a=0-9, A-Z or blank, represent for manufacturer code, no safety impact.) |
|---|---------------------------|---------------|------------------|----------------|--|
|   |                           | Voltage (Vdc) | Current (Max. A) | Power (Max. W) |  |
| FWE0x0yBz,<br>MWA0x0yBz<br>(x, y, z are variable) | 100-240Vac, 50-60Hz, 1.5A | 12-14         | 4.20             | 50             | 97660-476-aaa  |
|   |                           | 14.1-17       | 3.55             | 50             | 97660-487-aaa  |
|   |                           | 17.1-21.9     | 2.92             | 50             | 97660-488-aaa  |
|   |                           | 22-24         | 2.27             | 50             | 97660-477-aaa  |

## Variables definition

“x” x is 2 digital number from 30 to 50, which represent output power in watt in a step of 1W, for example, 50 represent for 50W.

“y” y is 2 digital number from 12 to 24, which represent output voltage in volt in a step of 1V, for example, 24 represent for 24V.

“z” z can be 0 to 9, A to Z or blank, it is only for marketing purpose, no safety impact.

By multiplication of output voltage and output current, the type designations are limited through the max. output power.



**ENERGY SOURCE IDENTIFICATION AND CLASSIFICATION TABLE:**

(Note 1: Identify the following six (6) energy source forms based on the origin of the energy.)

(Note 2: The identified classification e.g., ES2, TS1, should be with respect to its ability to cause pain or injury on the body or its ability to ignite a combustible material. Any energy source can be declared Class 3 as a worse case classification e.g. PS3, ES3.

**Electrically-caused injury (Clause 5):**

(Note: Identify type of source, list sub-assembly or circuit designation and corresponding energy source classification)

Example: +5 V dc input

ES1

**Source of electrical energy**
**Corresponding classification (ES)**

Primary circuit

ES3

Output circuit

ES1

**Electrically-caused fire (Clause 6):**

(Note: List sub-assembly or circuit designation and corresponding energy source classification)

Example: Battery pack (maximum 85 watts):

PS2

**Source of power or PIS**
**Corresponding classification (PS)**

Primary circuit

PS3

Output terminal

PS2

**Injury caused by hazardous substances (Clause 7)**

(Note: Specify hazardous chemicals, whether produces ozone or other chemical construction not addressed as part of the component evaluation.)

Example: Liquid in filled component

Glycol

**Source of hazardous substances**
**Corresponding chemical**

N/A

None

**Mechanically-caused injury (Clause 8)**

(Note: List moving part(s), fan, special installations, etc. & corresponding MS classification based on Table 35.)

Example: Wall mount unit

MS2

**Source of kinetic/mechanical energy**
**Corresponding classification (MS)**

Edges and corners of enclosure

MS1

Mass of the unit

MS1

**Thermal burn injury (Clause 9)**

(Note: Identify the surface or support, and corresponding energy source classification based on type of part, location, operating temperature and contact time in Table 38.)

Example: Hand-held scanner – thermoplastic enclosure

TS1

**Source of thermal energy**
**Corresponding classification (TS)**

External surfaces

TS1 for accessible part

**Radiation (Clause 10)**

(Note: List the types of radiation present in the product and the corresponding energy source classification.)

Example: DVD – Class 1 Laser Product

RS1

**Type of radiation**
**Corresponding classification (RS)**

N/A

N/A

**ENERGY SOURCE DIAGRAM**

Indicate which energy sources are included in the energy source diagram. Insert diagram below

**See above table**

**ES3 (on the left side of transformer T1), PS3 (on the left side of transformer T1), enclosure surface is TS1**

**ES1 (on the right side of transformer T1), output is PS2 energy source, all areas contains PIS sources**

ES

PS

MS

TS

RS

| <b>OVERVIEW OF EMPLOYED SAFEGUARDS</b>    |   |                        |                         |  |
|---|---|------------------------|-------------------------|--|
| <b>Clause</b>                             | <b>Possible Hazard</b>                              |                        |                         |  |
| 5.1                                       | Electrically-caused injury                          |                        |                         |  |
| Body Part<br>(e.g. Ordinary)              | Energy Source<br>(ES3: Primary Filter circuit)      | Safeguards             |                         |  |
|   |   | Basic                  | Supplement<br>ary       | Reinforced<br>(Enclosure)                              |
| Ordinary                                  | ES3: primary circuit                                | See 5.6                | N/A                     | Enclosure,<br>See 5.4.2,<br>5.4.3, 5.5.3,<br>and 5.5.4 |
| Ordinary                                  | ES3: Primary circuits<br>(Discharged capacitor)     | N/A                    | N/A                     | See 5.5.2.2  |
| Ordinary                                  | ES1: Output connector                               | N/A                    | N/A                     | N/A  |
| 6.1                                       | Electrically-caused fire                            |                        |                         |  |
| Material part<br>(e.g. mouse enclosure)   | Energy Source                                       | Safeguards             |                         |  |
|   |   | Basic                  | Supplement<br>ary       | Reinforced   |
| Combustible materials within<br>equipment | PS3: >100 Watt circuit<br>(Primary circuit)         | Equipment<br>safeguard | Equipment<br>safeguards | N/A  |
| Output connector                          | PS2: ≥15Watt, <100 Watt<br>circuit (output circuit) | Equipment<br>safeguard | N/A                     | N/A  |
| 7.1                                       | Injury caused by hazardous substances               |                        |                         |  |
| Body Part<br>(e.g., skilled)              | Energy Source<br>(hazardous material)               | Safeguards             |                         |  |
|   |   | Basic                  | Supplement<br>ary       | Reinforced   |
| N/A                                       | N/A   | N/A                    | N/A                     | N/A  |
| 8.1                                       | Mechanically-caused injury                          |                        |                         |  |
| Body Part<br>(e.g. Ordinary)              | Energy Source<br>(MS3:High Pressure<br>Lamp)        | Safeguards             |                         |  |
|   |   | Basic                  | Supplement<br>ary       | Reinforced<br>(Enclosure)                              |
| Ordinary                                  | MS1: Smooth Edges and<br>corners                    | N/A                    | N/A                     | N/A  |
| Mass of the unit                          | MS1: <7kg   | N/A                    | N/A                     | N/A  |
| 9.1                                       | Thermal Burn  |                        |                         |  |
| Body Part<br>(e.g., Ordinary)             | Energy Source<br>(TS2)                              | Safeguards             |                         |  |
|   |   | Basic                  | Supplement<br>ary       | Reinforced   |
| Ordinary                                  | TS1: Plastic enclosure                              | N/A                    | N/A                     | N/A  |
| 10.1                                      | Radiation   |                        |                         |  |
| Body Part<br>(e.g., Ordinary)             | Energy Source<br>(Output from audio port)           | Safeguards             |                         |  |
|   |   | Basic                  | Supplement<br>ary       | Reinforced   |
| N/A                                       | N/A   | N/A                    | N/A                     | N/A  |

Supplementary Information:

- (1) See attached energy source diagram for additional details.
- (2) "N" – Normal Condition; "A" – Abnormal Condition; "S" Single Fault

| IEC 62368-1 |   |  |         |
|-------------|---|--|---------|
| Clause      | Requirement + Test  | Result - Remark  | Verdict |
| <b>4</b>    | <b>GENERAL REQUIREMENTS</b>                                     |  | P       |
| 4.1.1       | Acceptance of materials, components and subassemblies           | See appended table 4.1.2   | P       |
| 4.1.2       | Use of components   | Components which are certified to IEC and/or national standards are used correctly within their ratings. Components not covered by IEC standards are tested under the conditions present in the equipment. See also Annex G. | P       |
| 4.1.3       | Equipment design and construction                               | Evaluation of safeguards regarding preventing access to ES3 parts, limiting the source supplying outputs to fulfill ES1, and protection in regard to risk of ignition, mechanical-caused injury and thermal burn considered. | P       |
| 4.1.15      | Markings and instructions .....                                 | (See Annex F)  | P       |
| 4.4.4       | Safeguard robustness  | See below.   | P       |
| 4.4.4.2     | Steady force tests .....  | (See Annex T.2, T.4 and T.5)   | P       |
| 4.4.4.3     | Drop tests.....   | (See Annex T.7)  | N/A     |
| 4.4.4.4     | Impact tests.....   | (See Annex T.6)  | P       |
| 4.4.4.5     | Internal accessible safeguard enclosure and barrier tests ..... | The external enclosure cannot be opened without damaging the product.  | N/A     |
| 4.4.4.6     | Glass Impact tests .....  | No such glass used.  | N/A     |
| 4.4.4.7     | Thermoplastic material tests .....                              | After 7 hours and cooling down to room temperature, no shrinkage, distortion or loosening any enclosure part was noticeable on the adapter. Test was performed for all sources of enclosure material, detail see Annex T.8.  | P       |
| 4.4.4.8     | Air comprising a safeguard .....                                | (See Annex T)  | P       |
| 4.4.4.9     | Accessibility and safeguard effectiveness                       | After tests of 4.4.4.2, 4.4.4.3, 4.4.4.7, no safeguard damaged.  | P       |
| 4.5         | Explosion   | No explosion occurs during normal/abnormal operation and single fault conditions   | P       |
| 4.6         | Fixing of conductors  |  | P       |
| 4.6.1       | Fix conductors not to defeat a safeguard                        | The conductors will be connected by wire terminals.  | P       |

| <b>IEC 62368-1</b> |  |   |         |
|--------------------|--|---|---------|
| Clause             | Requirement + Test   | Result - Remark   | Verdict |
| 4.6.2              | 10 N force test applied to .....                                       | See appended table 5.4.2.2, 5.4.2.4 and 5.4.3               | P       |
| 4.7                | Equipment for direct insertion into mains socket - outlets             | Desktop type  | N/A     |
| 4.7.2              | Mains plug part complies with the relevant standard .....              |   | N/A     |
| 4.7.3              | Torque (Nm).....   |   | N/A     |
| 4.8                | Products containing coin/button cell batteries                         | No coin/button cell batteries used.                         | N/A     |
| 4.8.2              | Instructional safeguard  |   | N/A     |
| 4.8.3              | Battery Compartment Construction                                       |   | N/A     |
|                    | Means to reduce the possibility of children removing the battery ..... |   | —       |
| 4.8.4              | Battery Compartment Mechanical Tests .....                             |   | N/A     |
| 4.8.5              | Battery Accessibility  |   | N/A     |
| 4.9                | Likelihood of fire or shock due to entry of conductive object .....    | No likelihood of conductive object entering into enclosure. | P       |

|          |   |   |     |
|----------|---|---|-----|
| <b>5</b> | <b>ELECTRICALLY-CAUSED INJURY</b>   |   | P   |
| 5.2.1    | Electrical energy source classifications.....   | (See appended table 5.2)  | P   |
| 5.2.2    | ES1, ES2 and ES3 limits   |   | P   |
| 5.2.2.2  | Steady-state voltage and current.....   | (See appended table 5.2)  | P   |
| 5.2.2.3  | Capacitance limits .....  |   | N/A |
| 5.2.2.4  | Single pulse limits.....  | No such single pulses generated in the EUT or applied to it.  | N/A |
| 5.2.2.5  | Limits for repetitive pulses .....  | No such repetitive pulses within the EUT  | N/A |
| 5.2.2.6  | Ringing signals .....   | No such ringing signals within the EUT  | N/A |
| 5.2.2.7  | Audio signals .....   | No such audio signals   | N/A |
| 5.3      | Protection against electrical energy sources  | See below   | P   |
| 5.3.1    | General Requirements for accessible parts to ordinary, instructed and skilled persons | See only 4.3 and 5.3 to 5.5 which applies to protection between the accessible parts and hazardous parts of other circuits. | P   |
| 5.3.2.1  | Accessibility to electrical energy sources and safeguards                             | Only ES1 circuit can be accessed for this product.  | P   |
| 5.3.2.2  | Contact requirements  | No openings allowing entry of a probe.<br>No access with test probe to any ES3 circuit or parts.                            | P   |

| IEC 62368-1 |   |  |         |
|-------------|---|--|---------|
| Clause      | Requirement + Test  | Result - Remark  | Verdict |
|             | a) Test with test probe from Annex V .....                                  |  | P       |
|             | b) Electric strength test potential (V) .....                               |  | N/A     |
|             | c) Air gap (mm) .....   |  | N/A     |
| 5.3.2.4     | Terminals for connecting stripped wire                                      | No stripped wire used.   | N/A     |
| 5.4         | Insulation materials and requirements                                       |  | P       |
| 5.4.1.2     | Properties of insulating material   | The choice and application have taken into account as specified in this Clause 5 and Annex T and natural rubber, hygroscopic materials or asbestos are not used as insulation. | P       |
| 5.4.1.3     | Humidity conditioning.....  | No hygroscopic material used.  | P       |
| 5.4.1.4     | Maximum operating temperature for insulating materials .....                | (See appended table 5.4.1.4, 6.3.2, 9.0, B.2.6)  | P       |
| 5.4.1.5     | Pollution degree .....  | 2  | —       |
| 5.4.1.5.2   | Test for pollution degree 1 environment and for an insulating compound      | Pollution degree 2 is applied. No insulating compound applied (however see 5.5.4).   | N/A     |
| 5.4.1.5.3   | Thermal cycling   | See above  | N/A     |
| 5.4.1.6     | Insulation in transformers with varying dimensions                          | No such transformer.   | N/A     |
| 5.4.1.7     | Insulation in circuits generating starting pulses                           | No such starting pulses.   | N/A     |
| 5.4.1.8     | Determination of working voltage  | (See appended table 5.4.1.8)   | P       |
| 5.4.1.9     | Insulating surfaces   |  | P       |
| 5.4.1.10    | Thermoplastic parts on which conductive metallic parts are directly mounted | See only 5.4.10.3 below.   | P       |
| 5.4.1.10.2  | Vicat softening temperature.....  |  | N/A     |
| 5.4.1.10.3  | Ball pressure .....   | See appended table 5.4.1.10.3.   | N/A     |
| 5.4.2       | Clearances  | The highest value of 5.4.3.3 and 5.4.2.3 be used.  | P       |
| 5.4.2.2     | Determining clearance using peak working voltage                            | Temporary overvoltage 2000V <sub>peak</sub> assumed.   | P       |
| 5.4.2.3     | Determining clearance using required withstand voltage .....                | (See appended table 5.4.2.2, 5.4.2.4 and 5.4.3)  | P       |
|             | a) a.c. mains transient voltage .....                                       | 2500 V <sub>pk</sub> considered for Overvoltage Cat. II  | —       |
|             | b) d.c. mains transient voltage .....                                       | Not d.c. mains.  | —       |
|             | c) external circuit transient voltage .....                                 | No such transient  | —       |
|             | d) transient voltage determined by measurement :                            |  | —       |

| <b>IEC 62368-1</b> |   |   |         |
|--------------------|---|---|---------|
| Clause             | Requirement + Test  | Result - Remark   | Verdict |
| 5.4.2.4            | Determining the adequacy of a clearance using an electric strength test | Using procedure 2 to determine the clearance according to 5.4.2.3.  | N/A     |
| 5.4.2.5            | Multiplication factors for clearances and test voltages .....           | 1.48  | P       |
| 5.4.3              | Creepage distances .....  | (See appended table 5.4.2.2, 5.4.2.4 and 5.4.3)   | P       |
| 5.4.3.1            | General   |   | P       |
| 5.4.3.3            | Material Group .....  | IIIa & IIIb   | —       |
| 5.4.4              | Solid insulation  | See below   | P       |
| 5.4.4.2            | Minimum distance through insulation .....                               | (See appended table 5.4.4.2)  | P       |
| 5.4.4.3            | Insulation compound forming solid insulation                            |   | N/A     |
| 5.4.4.4            | Solid insulation in semiconductor devices                               |   | N/A     |
| 5.4.4.5            | Cemented joints   |   | N/A     |
| 5.4.4.6            | Thin sheet material   | Tape used in Transformer  | P       |
| 5.4.4.6.1          | General requirements  | See below.  | P       |
| 5.4.4.6.2          | Separable thin sheet material   | Reinforced insulation consisting of two layers of tape, each layer shall pass the electric strength test for reinforced insulation. | P       |
|                    | Number of layers (pcs) .....  | 2   | P       |
| 5.4.4.6.3          | Non-separable thin sheet material                                       | No such insulation used within the EUT.   | N/A     |
| 5.4.4.6.4          | Standard test procedure for non-separable thin sheet material .....     |   | N/A     |
| 5.4.4.6.5          | Mandrel test  |   | N/A     |
| 5.4.4.7            | Solid insulation in wound components                                    | See G.5.3 and G.6.1 only.   | P       |
| 5.4.4.9            | Solid insulation at frequencies >30 kHz .....                           |   | P       |
| 5.4.5              | Antenna terminal insulation   | Class II  | P       |
| 5.4.5.1            | General   |   | P       |



| IEC 62368-1 |  |   |         |
|-------------|--|---|---------|
| Clause      | Requirement + Test   | Result - Remark   | Verdict |
| 5.4.5.2     | Voltage surge test   |   | P       |
|             | Insulation resistance (MΩ).....:                                     | >100MΩ  | N/A     |
| 5.4.6       | Insulation of internal wire as part of supplementary safeguard ..... | No such insulation of internal wire as part of supplementary safeguard. | N/A     |
| 5.4.7       | Tests for semiconductor components and for cemented joints           | No tests necessary –see only 5.4.4.4.                                   | N/A     |
| 5.4.8       | Humidity conditioning  |   | P       |
|             | Relative humidity (%).....:  | 95%   | —       |
|             | Temperature (°C) .....   | 40°C  | —       |
|             | Duration (h) .....   | 120h  | —       |
| 5.4.9       | Electric strength test .....   | (See appended table 5.4.9)  | P       |
| 5.4.9.1     | Test procedure for a solid insulation type test                      | (See appended table 5.4.9)  | P       |
| 5.4.9.2     | Test procedure for routine tests                                     | Should be considered and conducted during production at factory.        | N/A     |
| 5.4.10      | Protection against transient voltages between external circuit       | No such external circuits   | N/A     |
| 5.4.10.1    | Parts and circuits separated from external circuits                  |   | N/A     |
| 5.4.10.2    | Test methods   |   | N/A     |
| 5.4.10.2.1  | General  |   | N/A     |
| 5.4.10.2.2  | Impulse test .....   |   | N/A     |
| 5.4.10.2.3  | Steady-state test.....:  |   | N/A     |
| 5.4.11      | Insulation between external circuits and earthed circuitry.....:     | No such external circuit.   | N/A     |
| 5.4.11.1    | Exceptions to separation between external circuits and earth         |   | N/A     |
| 5.4.11.2    | Requirements   |   | N/A     |
|             | Rated operating voltage $U_{op}$ (V).....:                           |   | —       |
|             | Nominal voltage $U_{peak}$ (V).....:                                 |   | —       |
|             | Max increase due to variation $U_{sp}$ .....                         |   | —       |
|             | Max increase due to ageing $\Delta U_{sa}$ .....                     |   | —       |
|             | $U_{op} = U_{peak} + \Delta U_{sp} + \Delta U_{sa}$ .....            |   | —       |
| 5.5         | Components as safeguards   |   |         |
| 5.5.1       | General  | See below.  | P       |
| 5.5.2       | Capacitors and RC units  | Approved X, Y capacitor provided. See G.11.1.                           | P       |
| 5.5.2.1     | General requirement  |   | P       |

| IEC 62368-1 |   |  |         |
|-------------|---|--|---------|
| Clause      | Requirement + Test  | Result - Remark  | Verdict |
| 5.5.2.2     | Safeguards against capacitor discharge after disconnection of a connector .....       |  | P       |
| 5.5.3       | Transformers  | (See Annex G.5.3)  | P       |
| 5.5.4       | Optocouplers  |  | P       |
| 5.5.5       | Relays  | No such component provided   | N/A     |
| 5.5.6       | Resistors   |  | N/A     |
| 5.5.7       | SPD's   |  | N/A     |
| 5.5.7.1     | Use of an SPD connected to reliable earthing  |  | N/A     |
| 5.5.7.2     | Use of an SPD between mains and protective earth                                      |  | N/A     |
| 5.5.8       | Insulation between the mains and external circuit consisting of a coaxial cable ..... | No such external circuits.   | N/A     |
| 5.6         | Protective conductor  |  | N/A     |
| 5.6.2       | Requirement for protective conductors   |  | N/A     |
| 5.6.2.1     | General requirements  |  | N/A     |
| 5.6.2.2     | Colour of insulation  |  | N/A     |
| 5.6.3       | Requirement for protective earthing conductors  |  | N/A     |
|             | Protective earthing conductor size (mm <sup>2</sup> ) .....                           | See above.   | —       |
| 5.6.4       | Requirement for protective bonding conductors   |  | N/A     |
| 5.6.4.1     | Protective bonding conductors   |  | N/A     |
|             | Protective bonding conductor size (mm <sup>2</sup> ) .....                            |  | —       |
|             | Protective current rating (A) .....   |  | —       |
| 5.6.4.3     | Current limiting and overcurrent protective devices                                   |  | N/A     |
| 5.6.5       | Terminals for protective conductors   |  | N/A     |
| 5.6.5.1     | Requirement   |  | N/A     |
|             | Conductor size (mm <sup>2</sup> ), nominal thread diameter (mm).....                  |  | N/A     |
| 5.6.5.2     | Corrosion   |  | N/A     |
| 5.6.6       | Resistance of the protective system   |  | N/A     |
| 5.6.6.1     | Requirements  |  | N/A     |
| 5.6.6.2     | Test Method Resistance .....  |  | N/A     |
| 5.6.7       | Reliable earthing   |  | N/A     |
| 5.7         | Prospective touch voltage, touch current and protective conductor current             |  | P       |
| 5.7.2       | Measuring devices and networks  | Figure 4 & Figure 5 of IEC 60990 was used in determining of the value. | P       |

| <b>IEC 62368-1</b> |   |  |         |
|--------------------|---|--|---------|
| Clause             | Requirement + Test  | Result - Remark                                  | Verdict |
| 5.7.2.1            | Measurement of touch current.....   | (See appended table 5.2.2.2, 5.7.2.2, 5.7.4)     | P       |
| 5.7.2.2            | Measurement of prospective touch voltage  |  | P       |
| 5.7.3              | Equipment set-up, supply connections and earth connections                                    | Clause 4, 5.3 and 5.4 of IEC 60990:1999 applied. | P       |
|                    | System of interconnected equipment (separate connections/single connection) .....             | Single equipment.                                | —       |
|                    | Multiple connections to mains (one connection at a time/simultaneous connections) .....       | Single connection.                               | —       |
| 5.7.4              | Earthed conductive accessible parts .....   | See table 5.7.4                                  | N/A     |
| 5.7.5              | Protective conductor current  |  | N/A     |
|                    | Supply Voltage (V) .....  |  | —       |
|                    | Measured current (mA) .....   |  | —       |
|                    | Instructional Safeguard .....   |  | N/A     |
| 5.7.6              | Prospective touch voltage and touch current due to external circuits                          | No external circuits.                            | N/A     |
| 5.7.6.1            | Touch current from coaxial cables   |  | N/A     |
| 5.7.6.2            | Prospective touch voltage and touch current from external circuits                            |  | N/A     |
| 5.7.7              | Summation of touch currents from external circuits  | No external circuits.                            | N/A     |
|                    | a) Equipment with earthed external circuits Measured current (mA) .....                       |  | N/A     |
|                    | b) Equipment whose external circuits are not referenced to earth. Measured current (mA) ..... |  | N/A     |

|          |   |   |            |
|----------|---|---|------------|
| <b>6</b> | <b>ELECTRICALLY- CAUSED FIRE</b>  |   | <b>P</b>   |
| 6.2      | Classification of power sources (PS) and potential ignition sources (PIS) |   | <b>P</b>   |
| 6.2.2    | Power source circuit classifications                                      | PS (power source) classification determined by measuring the maximum power in Figures 34 and 35 for load and power source circuits. | <b>P</b>   |
| 6.2.2.1  | General   | See the following details.  | <b>P</b>   |
| 6.2.2.2  | Power measurement for worst-case load fault ...                           | (See appended table 6.2.2)  | <b>N/A</b> |
| 6.2.2.3  | Power measurement for worst-case power source fault.....                  | (See appended table 6.2.2)  | <b>N/A</b> |
| 6.2.2.4  | PS1 .....   | (See appended table 6.2.2)  | <b>N/A</b> |
| 6.2.2.5  | PS2 .....   | All output circuit is claimed as PS2  | <b>P</b>   |
| 6.2.2.6  | PS3 .....   | All circuit in enclosure is claimed as PS3  | <b>P</b>   |

| IEC 62368-1 |   |  |         |
|-------------|---|--|---------|
| Clause      | Requirement + Test  | Result - Remark  | Verdict |
| 6.2.3       | Classification of potential ignition sources  | See the following details.   | P       |
| 6.2.3.1     | Arcing PIS .....  | All circuit inside enclosure is claimed as Arcing PIS  | P       |
| 6.2.3.2     | Resistive PIS .....   | All circuit inside enclosure is claimed as Resistive PIS   | P       |
| 6.3         | Safeguards against fire under normal operating and abnormal operating conditions  |  | P       |
| 6.3.1 (a)   | No ignition and attainable temperature value less than 90 % defined by ISO 871 or less than 300 ° C for unknown materials ..... | No ignition and no such temperature attained within the equipment. (See appended table 5.4.1.4, 6.3.2, 9.0, B.2.6)   | P       |
| 6.3.1 (b)   | Combustible materials outside fire enclosure  | Only output wire and connector which comply with 6.4.5.  | P       |
| 6.4         | Safeguards against fire under single fault conditions   |  | P       |
| 6.4.1       | Safeguard Method  | Method by control of fire spread applied, Fire enclosure provided.   | P       |
| 6.4.2       | Reduction of the likelihood of ignition under single fault conditions in PS1 circuits   |  | N/A     |
| 6.4.3       | Reduction of the likelihood of ignition under single fault conditions in PS2 and PS3 circuits                                   |  | N/A     |
| 6.4.3.1     | General   |  | N/A     |
| 6.4.3.2     | Supplementary Safeguards  |  | N/A     |
|             | Special conditions if conductors on printed boards are opened or peeled   |  | N/A     |
| 6.4.3.3     | Single Fault Conditions :   |  | N/A     |
|             | Special conditions for temperature limited by fuse  |  | N/A     |
| 6.4.4       | Control of fire spread in PS1 circuits  |  | N/A     |
| 6.4.5       | Control of fire spread in PS2 circuits  | Compliance detailed as follows:<br><ul style="list-style-type: none"> <li>- <u>Printed board</u>: rated min. V-1</li> <li>- <u>Wire insulation (tubing)</u>: complying with Clause 6 (See Table 4.1.2 for wiring used).</li> <li>- <u>All other components</u>: at least V-2 except for mounted on min. V-1 material or small parts of combustible material.</li> <li>- <u>Isolating transformer</u>: complying with G.5.3.</li> </ul> | P       |
| 6.4.5.2     | Supplementary safeguards .....  | (See appended tables 4.1.2 and Annex G)  | P       |

| IEC 62368-1 |   |  |         |
|-------------|---|--|---------|
| Clause      | Requirement + Test  | Result - Remark  | Verdict |
| 6.4.6       | Control of fire spread in PS3 circuit   | Compliance detailed as follows:<br>– <u>Parts as in 6.4.5 above including wiring</u><br>– Fire enclosure rated V-0 used. | P       |
| 6.4.7       | Separation of combustible materials from a PIS  | Fire enclosure provided.   | N/A     |
| 6.4.7.1     | General..... :  |  | N/A     |
| 6.4.7.2     | Separation by distance  |  | N/A     |
| 6.4.7.3     | Separation by a fire barrier  | No specific barrier provided.  | N/A     |
| 6.4.8       | Fire enclosures and fire barriers   | See below.   | P       |
| 6.4.8.1     | Fire enclosure and fire barrier material properties   | The V-0 material is used for the fire enclosure (overall enclosure).   | P       |
| 6.4.8.2.1   | Requirements for a fire barrier   | No fire barrier used.  | N/A     |
| 6.4.8.2.2   | Requirements for a fire enclosure   | The V-0 fire enclosure is used.<br>See above.  | P       |
| 6.4.8.3     | Constructional requirements for a fire enclosure and a fire barrier                               |  | P       |
| 6.4.8.3.1   | Fire enclosure and fire barrier openings  |  | P       |
| 6.4.8.3.2   | Fire barrier dimensions   |  | N/A     |
| 6.4.8.3.3   | Top Openings in Fire Enclosure: dimensions (mm) .....   | No openings  | N/A     |
|             | Needle Flame test   |  | N/A     |
| 6.4.8.3.4   | Bottom Openings in Fire Enclosure, condition met a), b) and/or c) dimensions (mm) .....           | No opening   | N/A     |
|             | Flammability tests for the bottom of a fire enclosure .....                                       |  | N/A     |
| 6.4.8.3.5   | Integrity of the fire enclosure, condition met: a), b) or c) .....                                |  | N/A     |
| 6.4.8.4     | Separation of PIS from fire enclosure and fire barrier distance (mm) or flammability rating ..... | Fire enclosure is made of V-0 material.  | P       |
| 6.5         | Internal and external wiring  |  | P       |
| 6.5.1       | Requirements  | Internal input wire and output cord provided   | P       |
| 6.5.2       | Cross-sectional area (mm <sup>2</sup> ) .....   | See table 4.1.2  | —       |
| 6.5.3       | Requirements for interconnection to building wiring .....   | (See Annex Q.)   | N/A     |
| 6.6         | Safeguards against fire due to connection to additional equipment                                 |  | N/A     |
|             | External port limited to PS2 or complies with Clause Q.1  |  | N/A     |

| IEC 62368-1 |   |  |          |
|-------------|---|--|----------|
| Clause      | Requirement + Test  | Result - Remark  | Verdict  |
| <b>7</b>    | <b>INJURY CAUSED BY HAZARDOUS SUBSTANCES</b>                                |  | <b>P</b> |
| 7.2         | Reduction of exposure to hazardous substances                               | No hazardous chemicals within the equipment.                             | P        |
| 7.3         | Ozone exposure  | No ozone production within the equipment.                                | N/A      |
| 7.4         | Use of personal safeguards (PPE)  |  | N/A      |
|             | Personal safeguards and instructions .....                                  |  | —        |
| 7.5         | Use of instructional safeguards and instructions                            |  | N/A      |
|             | Instructional safeguard (ISO 7010) .....                                    |  | —        |
| 7.6         | Batteries.....  | No battery used.   | N/A      |
| <b>8</b>    | <b>MECHANICALLY-CAUSED INJURY</b>   |  | <b>P</b> |
| 8.1         | General   | No moving parts in the equipment. See below regarding edges and corners. | P        |
| 8.2         | Mechanical energy source classifications                                    | MS1  | P        |
| 8.3         | Safeguards against mechanical energy sources                                |  | N/A      |
| 8.4         | Safeguards against parts with sharp edges and corners                       | Edges and corners of the enclosure are rounded.                          | P        |
| 8.4.1       | Safeguards  |  | N/A      |
| 8.5         | Safeguards against moving parts   | No moving parts.   | N/A      |
| 8.5.1       | MS2 or MS3 part required to be accessible for the function of the equipment |  | N/A      |
| 8.5.2       | Instructional Safeguard.....  |  | —        |
| 8.5.4       | Special categories of equipment comprising moving parts                     |  | N/A      |
| 8.5.4.1     | Large data storage equipment  |  | N/A      |
| 8.5.4.2     | Equipment having electromechanical device for destruction of media          |  | N/A      |
| 8.5.4.2.1   | Safeguards and Safety Interlocks .....                                      |  | N/A      |
| 8.5.4.2.2   | Instructional safeguards against moving parts                               |  | N/A      |
|             | Instructional Safeguard.....  |  | —        |
| 8.5.4.2.3   | Disconnection from the supply   |  | N/A      |
| 8.5.4.2.4   | Probe type and force (N) .....  |  | N/A      |
| 8.5.5       | High Pressure Lamps   |  | N/A      |
| 8.5.5.1     | Energy Source Classification  |  | N/A      |

| IEC 62368-1 |   |   |         |
|-------------|---|---|---------|
| Clause      | Requirement + Test  | Result - Remark   | Verdict |
| 8.5.5.2     | High Pressure Lamp Explosion Test.....:                           |   | N/A     |
| 8.6         | Stability   | Classification MS1 according to table 35, line 5 and no stability requirements. | N/A     |
| 8.6.1       | Product classification  |   | N/A     |
|             | Instructional Safeguard.....:                                     |   | —       |
| 8.6.2       | Static stability  |   | N/A     |
| 8.6.2.2     | Static stability test   |   | N/A     |
|             | Applied Force .....   |   | —       |
| 8.6.2.3     | Downward Force Test   |   | N/A     |
| 8.6.3       | Relocation stability test   |   | N/A     |
|             | Unit configuration during 10 • tilt .....                         |   | —       |
| 8.6.4       | Glass slide test  |   | N/A     |
| 8.6.5       | Horizontal force test (Applied Force).....                        |   | N/A     |
|             | Position of feet or movable parts.....                            |   | —       |
| 8.7         | Equipment mounted to wall or ceiling                              |   | N/A     |
| 8.7.1       | Mounting Means (Length of screws (mm) and mounting surface) ..... |   | N/A     |
| 8.7.2       | Direction and applied force.....                                  |   | N/A     |
| 8.8         | Handles strength  |   | N/A     |
| 8.8.1       | Classification  |   | N/A     |
| 8.8.2       | Applied Force .....   |   | N/A     |
| 8.9         | Wheels or casters attachment requirements                         |   | N/A     |
| 8.9.1       | Classification  |   | N/A     |
| 8.9.2       | Applied force .....   |   | —       |
| 8.10        | Carts, stands and similar carriers                                |   | N/A     |
| 8.10.1      | General   |   | N/A     |
| 8.10.2      | Marking and instructions  |   | N/A     |
|             | Instructional Safeguard.....                                      |   | —       |
| 8.10.3      | Cart, stand or carrier loading test and compliance                |   | N/A     |
|             | Applied force .....   |   | —       |
| 8.10.4      | Cart, stand or carrier impact test                                |   | N/A     |
| 8.10.5      | Mechanical stability  |   | N/A     |
|             | Applied horizontal force (N) .....                                |   | —       |
| 8.10.6      | Thermoplastic temperature stability (°C).....                     |   | N/A     |

| <b>IEC 62368-1</b> |  |                 |         |
|--------------------|--|-----------------|---------|
| Clause             | Requirement + Test                                 | Result - Remark | Verdict |
| 8.11               | Mounting means for rack mounted equipment          |                 | N/A     |
| 8.11.1             | General  |                 | N/A     |
| 8.11.2             | Product Classification                             |                 | N/A     |
| 8.11.3             | Mechanical strength test, variable N .....         |                 | N/A     |
| 8.11.4             | Mechanical strength test 250N, including end stops |                 | N/A     |
| 8.12               | Telescoping or rod antennas.....                   | No such parts.  | N/A     |
|                    | Button/Ball diameter (mm).....                     |                 | —       |

| <b>9</b> | <b>THERMAL BURN INJURY</b>               |  | <b>P</b> |
|----------|--|--|----------|
| 9.2      | Thermal energy source classifications    | No part considered to be accessible other than enclosure. The equipment evaluated by temperature test (see table 5.4.1.4). | P        |
| 9.3      | Safeguard against thermal energy sources | Temperature of enclosure classed as TS1.   | P        |
| 9.4      | Requirements for safeguards              |  | P        |
| 9.4.1    | Equipment safeguard                      |  | P        |
| 9.4.2    | Instructional safeguard .....            |  | N/A      |

| <b>10</b> | <b>RADIATION</b>                                       |  | <b>N/A</b> |
|-----------|--|--|------------|
| 10.2      | Radiation energy source classification                 |  | N/A        |
| 10.2.1    | General classification                                 |  | N/A        |
| 10.3      | Protection against laser radiation                     |  | N/A        |
|           | Laser radiation that exists equipment:                 |  | —          |
|           | Normal, abnormal, single-fault .....                   |  | N/A        |
|           | Instructional safeguard.....                           |  | —          |
|           | Tool .....   |  | —          |
| 10.4      | Protection against visible, infrared, and UV radiation |  | N/A        |
| 10.4.1    | General  |  | N/A        |
| 10.4.1.a) | RS3 for Ordinary and instructed persons.....           |  | N/A        |
| 10.4.1.b) | RS3 accessible to a skilled person .....               |  | N/A        |
|           | Personal safeguard (PPE) instructional safeguard ..... |  | —          |
| 10.4.1.c) | Equipment visible, IR, UV does not exceed RS1 .....    |  | N/A        |



| <b>IEC 62368-1</b> |  |                     |         |
|--------------------|--|---------------------|---------|
| Clause             | Requirement + Test   | Result - Remark     | Verdict |
| 10.4.1.d)          | Normal, abnormal, single-fault conditions :                          |                     | N/A     |
| 10.4.1.e)          | Enclosure material employed as safeguard is opaque .....             |                     | N/A     |
| 10.4.1.f)          | UV attenuation .....   |                     | N/A     |
| 10.4.1.g)          | Materials resistant to degradation UV:                               |                     | N/A     |
| 10.4.1.h)          | Enclosure containment of optical radiation .....                     |                     | N/A     |
| 10.4.1.i)          | Exempt Group under normal operating conditions .....                 |                     | N/A     |
| 10.4.2             | Instructional safeguard .....  |                     | N/A     |
| 10.5               | Protection against x-radiation                                       |                     | N/A     |
| 10.5.1             | X- radiation energy source that exists equipment .....               |                     | N/A     |
|                    | Normal, abnormal, single fault conditions                            |                     | N/A     |
|                    | Equipment safeguards:  |                     | N/A     |
|                    | Instructional safeguard for skilled person .....                     |                     | N/A     |
| 10.5.3             | Most unfavourable supply voltage to give maximum radiation:          |                     | —       |
|                    | Abnormal and single-fault condition:                                 |                     | N/A     |
|                    | Maximum radiation (pA/kg):   |                     | N/A     |
| 10.6               | Protection against acoustic energy sources                           | Not such equipment. | N/A     |
| 10.6.1             | General  |                     | N/A     |
| 10.6.2             | Classification   |                     | N/A     |
|                    | Acoustic output, dB(A) .....   |                     | N/A     |
|                    | Output voltage, unweighted r.m.s. ....                               |                     | N/A     |
| 10.6.4             | Protection of persons  |                     | N/A     |
|                    | Instructional safeguards .....                                       |                     | N/A     |
|                    | Equipment safeguard prevent ordinary person to RS2 .....             |                     | —       |
|                    | Means to actively inform user of increase sound pressure .....       |                     | —       |
|                    | Equipment safeguard prevent ordinary person to RS2 .....             |                     | —       |
| 10.6.5             | Requirements for listening devices (headphones, earphones, etc.)     |                     | N/A     |
| 10.6.5.1           | Corded passive listening devices with analog input                   |                     | N/A     |
|                    | Input voltage with 94 dB(A) $L_{Aeq}$ acoustic pressure output ..... |                     | —       |
| 10.6.5.2           | Corded listening devices with digital input                          |                     | N/A     |

| <b>IEC 62368-1</b> |                           |                 |         |
|--------------------|---------------------------|-----------------|---------|
| Clause             | Requirement + Test        | Result - Remark | Verdict |
|                    | Maximum dB(A) .....       |                 | —       |
| 10.6.5.3           | Cordless listening device |                 | N/A     |
|                    | Maximum dB(A) .....       |                 | —       |

| IEC 62368-1 |  |   |         |
|-------------|--|---|---------|
| Clause      | Requirement + Test   | Result - Remark   | Verdict |
| <b>B</b>    | <b>NORMAL OPERATING CONDITION TESTS, ABNORMAL OPERATING CONDITION TESTS AND SINGLE FAULT CONDITION TESTS</b> |   | P       |
| B.2         | Normal Operating Conditions  |   | P       |
| B.2.1       | General requirements:  | (See summary of testing for tested models, each loaded according to its output ratings. See also appended table B.2.5.) | P       |
|             | Audio Amplifiers and equipment with audio amplifiers.....  | Not such equipment.   | N/A     |
| B.2.3       | Supply voltage and tolerances  | +10 % and -10 % considered.   | P       |
| B.2.5       | Input test .....   | (See appended table B.2.5)  | P       |
| B.3         | Simulated abnormal operating conditions  |   | P       |
| B.3.1       | General requirements:  | (See appended table B.3 )   | P       |
| B.3.2       | Covering of ventilation openings   |   | N/A     |
| B.3.3       | D.C. mains polarity test   | The EUT is not connected to a D.C. mains  | N/A     |
| B.3.4       | Setting of voltage selector:   | No voltage selector was used.   | N/A     |
| B.3.5       | Maximum load at output terminals:  | (See appended table B.3)  | P       |
| B.3.6       | Reverse battery polarity   | No battery within the EUT   | N/A     |
| B.3.7       | Abnormal operating conditions as specified in Clause E.2.  | Not such equipment.   | N/A     |
| B.3.8       | Safeguards functional during and after abnormal operating conditions   | All safeguards remained effective.  | P       |
| B.4         | Simulated single fault conditions  |   | P       |
| B.4.2       | Temperature controlling device open or short-circuited:  | No such device used.  | N/A     |
| B.4.3       | Motor tests  | No motors used.   | N/A     |
| B.4.3.1     | Motor blocked or rotor locked increasing the internal ambient temperature :                                  |   | N/A     |
| B.4.4       | Short circuit of functional insulation   | See below.  | P       |
| B.4.4.1     | Short circuit of clearances for functional insulation  | (See appended table B.4)  | P       |
| B.4.4.2     | Short circuit of creepage distances for functional insulation  | (See appended table B.4)  | P       |
| B.4.4.3     | Short circuit of functional insulation on coated printed boards  | No coated printed boards used.  | N/A     |
| B.4.5       | Short circuit and interruption of electrodes in tubes and semiconductors                                     | (See appended table B.4 for faults on semiconductor components)   | P       |
| B.4.6       | Short circuit or disconnect of passive components  | (See appended table B.4)  | P       |

| <b>IEC 62368-1</b> |   |   |         |
|--------------------|---|---|---------|
| Clause             | Requirement + Test  | Result - Remark   | Verdict |
| B.4.7              | Continuous operation of components  | The EUT is continuous operating type and no such components intended for short time operation or intermittent operation | N/A     |
| B.4.8              | Class 1 and Class 2 energy sources within limits during and after single fault conditions |   | P       |
| B.4.9              | Battery charging under single fault conditions...:  | No battery involved in the EUT  | N/A     |
| <b>C</b>           | <b>UV RADIATION</b>   |   | N/A     |
| C.1                | Protection of materials in equipment from UV radiation                                    | No UV generated from the equipment.   | N/A     |
| C.1.2              | Requirements  |   | N/A     |
| C.1.3              | Test method   |   | N/A     |
| C.2                | UV light conditioning test  |   | N/A     |
| C.2.1              | Test apparatus  |   | N/A     |
| C.2.2              | Mounting of test samples  |   | N/A     |
| C.2.3              | Carbon-arc light-exposure apparatus   |   | N/A     |
| C.2.4              | Xenon-arc light exposure apparatus  |   | N/A     |
| <b>D</b>           | <b>TEST GENERATORS</b>  |   | P       |
| D.1                | Impulse test generators   |   | N/A     |
| D.2                | Antenna interface test generator  |   | P       |
| D.3                | Electronic pulse generator  |   | N/A     |
| <b>E</b>           | <b>TEST CONDITIONS FOR EQUIPMENT CONTAINING AUDIO AMPLIFIERS</b>                          |   | N/A     |
| E.1                | Audio amplifier normal operating conditions   | Not such equipment.   | N/A     |
|                    | Audio signal voltage (V) .....  |   | —       |
|                    | Rated load impedance ( $\Omega$ ) .....   |   | —       |
| E.2                | Audio amplifier abnormal operating conditions   |   | N/A     |

| IEC 62368-1 |   |  |         |
|-------------|---|--|---------|
| Clause      | Requirement + Test  | Result - Remark  | Verdict |
| <b>F</b>    | <b>EQUIPMENT MARKINGS, INSTRUCTIONS, AND INSTRUCTIONAL SAFEGUARDS</b> |  | P       |
| F.1         | General requirements  | See below.   | P       |
|             | Instructions – Language .....   | English user manual provided.  | —       |
| F.2         | Letter symbols and graphical symbols                                  |  | P       |
| F.2.1       | Letter symbols according to IEC60027-1                                | Letter symbols for quantities and units are complied with IEC 60027-1.                   | N/A     |
| F.2.2       | Graphic symbols IEC, ISO or manufacturer specific                     | Graphical symbols are complied with IEC 60417, ISO 3864-2, ISO 7000 or ISO 7010.         | P       |
| F.3         | Equipment markings  |  | P       |
| F.3.1       | Equipment marking locations   | The required marking is located on the enclosure of the equipment and is easily visible. | P       |
| F.3.2       | Equipment identification markings                                     | See copy of marking plate.   | P       |
| F.3.2.1     | Manufacturer identification .....                                     | See copy of marking plate.   | —       |
| F.3.2.2     | Model identification .....  | See model list.  | —       |
| F.3.3       | Equipment rating markings   | See the following details.   | P       |
| F.3.3.1     | Equipment with direct connection to mains                             | The equipment is direct connected to AC mains, see F.3.3.3 to F.3.3.6.                   | P       |
| F.3.3.2     | Equipment without direct connection to mains                          |  | N/A     |
| F.3.3.3     | Nature of supply voltage .....  | AC   | —       |
| F.3.3.4     | Rated voltage .....   | See copy of marking plate.   | —       |
| F.3.3.4     | Rated frequency .....   | See copy of marking plate.   | —       |
| F.3.3.6     | Rated current or rated power .....                                    | See copy of marking plate.   | —       |
| F.3.3.7     | Equipment with multiple supply connections                            | Only one mains supply connection provided.   | N/A     |
| F.3.4       | Voltage setting device  | No voltage setting device.   | N/A     |
| F.3.5       | Terminals and operating devices                                       | See below.   | P       |
| F.3.5.1     | Mains appliance outlet and socket-outlet markings:                    | No outlet used.  | N/A     |
| F.3.5.2     | Switch position identification marking:                               | No switch used.  | N/A     |
| F.3.5.3     | Replacement fuse identification and rating markings<br>.....<br>:     | Current fuse used, marking provided on PCB adjacent to them:<br>F1: T2A/250V.            | P       |
| F.3.5.4     | Replacement battery identification marking:                           | No such battery on the equipment. See sub-clause F.5                                     | N/A     |

| <b>IEC 62368-1</b> |  |  |         |
|--------------------|--|--|---------|
| Clause             | Requirement + Test   | Result - Remark  | Verdict |
| F.3.5.5            | Terminal marking location  |  | N/A     |
| F.3.6              | Equipment markings related to equipment classification   | See below.   | P       |
| F.3.6.1            | Class I Equipment  | Class II equipment.  | N/A     |
| F.3.6.1.1          | Protective earthing conductor terminal   |  | N/A     |
| F.3.6.1.2          | Neutral conductor terminal   |  | N/A     |
| F.3.6.1.3          | Protective bonding conductor terminals   |  | N/A     |
| F.3.6.2            | Class II equipment (IEC60417-5172)   |  | P       |
| F.3.6.2.1          | Class II equipment with or without functional earth  | Without functional earth   | P       |
| F.3.6.2.2          | Class II equipment with functional earth terminal marking  |  | N/A     |
| F.3.7              | Equipment IP rating marking .....  | IPX0   | —       |
| F.3.8              | External power supply output marking   | See copy of marking plate.   | P       |
| F.3.9              | Durability, legibility and permanence of marking   | Marking is considered to be legible and easily discernible. See also the following details.  | P       |
| F.3.10             | Test for permanence of markings  | The label was subjected to the permanence of marking test. The label was rubbed with cloth soaked with water for 15 sec. And then again for 15 sec. With the cloth soaked with petroleum spirit.<br>After this test there was no damage to the label. The marking on the label did not fade. There was no curling and lifting of the label edge.<br>After each test, the marking remained legible. | P       |
| F.4                | Instructions   |  | P       |
|                    | a) Equipment for use in locations where children not likely to be present - marking                            |  | N/A     |
|                    | b) Instructions given for installation or initial use  | user manual was available  | P       |
|                    | c) Equipment intended to be fastened in place  |  | N/A     |
|                    | d) Equipment intended for use only in restricted access area   |  | N/A     |
|                    | e) Audio equipment terminals classified as ES3 and other equipment with terminals marked in accordance F.3.6.1 | No such terminals provided.  | N/A     |
|                    | f) Protective earthing employed as safeguard   |  | N/A     |

| <b>IEC 62368-1</b> |   |  |         |
|--------------------|---|--|---------|
| Clause             | Requirement + Test  | Result - Remark  | Verdict |
|                    | g) Protective earthing conductor current exceeding ES2 limits   |  | N/A     |
|                    | h) Symbols used on equipment  | No such symbols used as a safeguard considered.        | N/A     |
|                    | i) Permanently connected equipment not provided with all-pole mains switch  | Not permanently connected equipment.                   | N/A     |
|                    | j) Replaceable components or modules providing safeguard function   | No such markings.                                      | N/A     |
| F.5                | Instructional safeguards  | No instructional safeguard is considered as necessary. | N/A     |
|                    | Where "instructional safeguard" is referenced in the test report it specifies the required elements, location of marking and/or instruction | No instructional safeguard required in the equipment.  | N/A     |

|               |  |                          |          |
|---------------|--|--------------------------|----------|
| <b>G</b>      | <b>COMPONENTS</b>  |                          | <b>P</b> |
| <b>G.1</b>    | <b>Switches</b>  |                          | N/A      |
| G.1.1         | General requirements   | No switch used.          | N/A      |
| G.1.2         | Ratings, endurance, spacing, maximum load  |                          | N/A      |
| <b>G.2</b>    | <b>Relays</b>  |                          | N/A      |
| G.2.1         | General requirements   | No relay used.           | N/A      |
| G.2.2         | Overload test  |                          | N/A      |
| G.2.3         | Relay controlling connectors supply power  |                          | N/A      |
| G.2.4         | Mains relay, modified as stated in G.2   |                          | N/A      |
| <b>G.3</b>    | <b>Protection Devices</b>  |                          | <b>P</b> |
| G.3.1         | Thermal cut-offs   | No thermal cut-off used. | N/A      |
| G.3.1.1a) &b) | Thermal cut-outs separately approved according to IEC 60730 with conditions indicated in a) & b) |                          | N/A      |
| G.3.1.1c)     | Thermal cut-outs tested as part of the equipment as indicated in c)                              |                          | N/A      |
| G.3.1.2       | Thermal cut-off connections maintained and secure  |                          | N/A      |
| G.3.2         | Thermal links  |                          | N/A      |
| G.3.2.1a)     | Thermal links separately tested with IEC 60691   | No thermal link used.    | N/A      |
| G.3.2.1b)     | Thermal links tested as part of the equipment  |                          | N/A      |
|               | Aging hours (H):   |                          | —        |
|               | Single Fault Condition:  |                          | —        |
|               | Test Voltage (V) and Insulation Resistance ( $\Omega$ ):   |                          | —        |
| G.3.3         | PTC Thermistors  | No PTC thermistor used.  | N/A      |

| IEC 62368-1  |  |  |         |
|--------------|--|--|---------|
| Clause       | Requirement + Test   | Result - Remark  | Verdict |
| G.3.4        | Overcurrent protection devices   |  | P       |
| G.3.5        | Safeguards components not mentioned in G.3.1 to G.3.5                                    |  | P       |
| G.3.5.1      | Non-resettable devices suitably rated and marking provided                               | See F.3.5.3  | P       |
| G.3.5.2      | Single faults conditions .....   | (See appended Table B.4)   | P       |
| <b>G.4</b>   | <b>Connectors</b>  |  | P       |
| G.4.1        | Spacings   |  | N/A     |
| G.4.2        | Mains connector configuration .....  | Refer to sub-clause 4.7  | P       |
| G.4.3        | Plug is shaped that insertion into mains socket-outlets or appliance coupler is unlikely | Output connector with a shape that insert into mains connector is unlikely to occur.   | P       |
| <b>G.5</b>   | <b>Wound Components</b>  |  | P       |
| G.5.1        | Wire insulation in wound components .....  | Approved Insulated wire used as Reinforced insulation for secondary winding of T1.   | P       |
| G.5.1.2 a)   | Two wires in contact inside wound component, angle between 45° and 90°                   | Physical separation provided by tape.  | P       |
| G.5.1.2 b)   | Construction subject to routine testing  |  | N/A     |
| G.5.2        | Endurance test on wound components   |  | N/A     |
| G.5.2.1      | General test requirements  |  | N/A     |
| G.5.2.2      | Heat run test  |  | N/A     |
|              | Time (s) .....   |  | —       |
|              | Temperature (°C) .....   |  | —       |
| G.5.2.3      | Wound Components supplied by mains   |  | N/A     |
| <b>G.5.3</b> | <b>Transformers</b>  |  | P       |
| G.5.3.1      | Requirements applied (IEC61204-7, IEC61558-1/-2, and/or IEC62368-1):                     | The transformer meets the requirements given in G.5.3.2 and G.5.3.3.   | P       |
|              | Position:  | T1   | —       |
|              | Method of protection :   | See G.5.3.3.   | —       |
| G.5.3.2      | Insulation   | Primary windings and secondary windings are separated by Reinforced insulation (The core is considered as primary part as it is not isolated from Primary) | P       |
|              | Protection from displacement of windings .....   | By bobbin and insulating tape  | —       |
| G.5.3.3      | Overload test:   | (See appended table B.3)   | P       |
| G.5.3.3.1    | Test conditions  |  | P       |
| G.5.3.3.2    | Winding Temperatures testing in the unit   | (See appended table B.)  | P       |



| <b>IEC 62368-1</b> |  |  |         |
|--------------------|--|--|---------|
| Clause             | Requirement + Test   | Result - Remark  | Verdict |
| G.5.3.3.3          | Winding Temperatures - Alternative test method                     | Alternative test method was not considered.  | N/A     |
| <b>G.5.4</b>       | <b>Motors</b>  |  | N/A     |
| G.5.4.1            | General requirements   | No motor used.   | N/A     |
|                    | Position .....   |  | —       |
| G.5.4.2            | Test conditions  |  | N/A     |
| G.5.4.3            | Running overload test  |  | N/A     |
| G.5.4.4            | Locked-rotor overload test   |  | N/A     |
|                    | Test duration (days) .....   |  | —       |
| G.5.4.5            | Running overload test for d.c. motors in secondary circuits        |  | N/A     |
| G.5.4.5.2          | Tested in the unit   |  | N/A     |
|                    | Electric strength test (V).....                                    |  | —       |
| G.5.4.5.3          | Tested on the Bench - Alternative test method; test time (h) ..... |  | N/A     |
|                    | Electric strength test (V).....                                    |  | —       |
| G.5.4.6            | Locked-rotor overload test for d.c. motors in secondary circuits   |  | N/A     |
| G.5.4.6.2          | Tested in the unit   |  | N/A     |
|                    | Maximum Temperature .....  |  | N/A     |
|                    | Electric strength test (V) .....                                   |  | N/A     |
| G.5.4.6.3          | Tested on the bench - Alternative test method; test time (h) ..... |  | N/A     |
|                    | Electric strength test (V).....                                    |  | N/A     |
| G.5.4.7            | Motors with capacitors   |  | N/A     |
| G.5.4.8            | Three-phase motors   |  | N/A     |
| G.5.4.9            | Series motors  |  | N/A     |
|                    | Operating voltage .....  |  | —       |
| <b>G.6</b>         | <b>Wire Insulation</b>   |  | P       |
| G.6.1              | General  | Triple insulated winding in T1 secondary windings used as reinforced safeguard in the isolating transformer that has separately complied with Annex J. | P       |
| G.6.2              | Solvent-based enamel wiring insulation                             | Insulation does not rely on solvent-based enamel.  | P       |
| <b>G.7</b>         | <b>Mains supply cords</b>  |  | N/A     |
| G.7.1              | General requirements   | Shall be evaluated with end product  | N/A     |

| IEC 62368-1 |   |   |         |
|-------------|---|---|---------|
| Clause      | Requirement + Test  | Result - Remark   | Verdict |
|             | Type .....  |   | —       |
|             | Rated current (A).....  |   | —       |
|             | Cross-sectional area (mm <sup>2</sup> ), (AWG).....                     |   | —       |
| G.7.2       | Compliance and test method  |   | N/A     |
| G.7.3       | Cord anchorages and strain relief for non-detachable power supply cords |   | N/A     |
| G.7.3.2     | Cord strain relief  |   | N/A     |
| G.7.3.2.1   | Requirements  |   | N/A     |
|             | Strain relief test force (N) .....                                      |   | —       |
| G.7.3.2.2   | Strain relief mechanism failure   |   | N/A     |
| G.7.3.2.3   | Cord sheath or jacket position, distance (mm) ...                       |   | —       |
| G.7.3.2.4   | Strain relief comprised of polymeric material                           |   | N/A     |
| G.7.4       | Cord Entry .....  |   | N/A     |
| G.7.5       | Non-detachable cord bend protection                                     |   | N/A     |
| G.7.5.1     | Requirements  |   | N/A     |
| G.7.5.2     | Mass (g) .....  |   | —       |
|             | Diameter (m) .....  |   | —       |
|             | Temperature (°C).....   |   | —       |
| G.7.6       | Supply wiring space   |   | N/A     |
| G.7.6.2     | Stranded wire   | No such wire.   | N/A     |
| G.7.6.2.1   | Test with 8 mm strand   |   | N/A     |
| <b>G.8</b>  | <b>Varistors</b>  |   | P       |
| G.8.1       | General requirements  | Approve surge suppressor used after mains current fuse or fuse resistor | P       |
| G.8.2       | Safeguard against shock   |   | P       |
| G.8.3       | Safeguard against fire  |   | N/A     |
| G.8.3.2     | Varistor overload test .....  |   | N/A     |
| G.8.3.3     | Temporary overvoltage .....   |   | N/A     |
| <b>G.9</b>  | <b>Integrated Circuit (IC) Current Limiters</b>                         |   | N/A     |
| G.9.1 a)    | Manufacturer defines limit at max. 5A.                                  | No IC current limiter provided within the equipment.                    | N/A     |
| G.9.1 b)    | Limiters do not have manual operator or reset                           |   | N/A     |
| G.9.1 c)    | Supply source does not exceed 250 VA .....                              |   | —       |
| G.9.1 d)    | IC limiter output current (max. 5A) .....                               |   | —       |
| G.9.1 e)    | Manufacturers' defined drift .....                                      |   | —       |

| <b>IEC 62368-1</b> |   |  |         |
|--------------------|---|--|---------|
| Clause             | Requirement + Test  | Result - Remark  | Verdict |
| G.9.2              | Test Program 1  |  | N/A     |
| G.9.3              | Test Program 2  |  | N/A     |
| G.9.4              | Test Program 3  |  | N/A     |
| <b>G.10</b>        | <b>Resistors</b>  |  | N/A     |
| G.10.1             | General requirements  |  | N/A     |
| G.10.2             | Resistor test   |  | N/A     |
| G.10.3             | Test for resistors serving as safeguards between the mains and an external circuit consisting of a coaxial cable      |  | N/A     |
| G.10.3.1           | General requirements  |  | N/A     |
| G.10.3.2           | Voltage surge test  |  | N/A     |
| G.10.3.3           | Impulse test  |  | N/A     |
| <b>G.11</b>        | <b>Capacitor and RC units</b>   |  | P       |
| G.11.1             | General requirements  | Capacitors used in accordance with their rating and complied with subclasses of IEC 60384-14. (see appended table 4.1.2)                           | P       |
| G.11.2             | Conditioning of capacitors and RC units   | (see appended table 4.1.2)   | P       |
| G.11.3             | Rules for selecting capacitors  | The selection followed with tables G.9 and G.12.   | P       |
| <b>G.12</b>        | <b>Optocouplers</b>   |  | P       |
|                    | Optocouplers comply with IEC 60747-5-5:2007 Spacing or Electric Strength Test (specify option and test results).....: | Approval optocoupler.  | P       |
|                    | Type test voltage V <sub>ini</sub> .....  |  | —       |
|                    | Routine test voltage, V <sub>ini,b</sub> .....  |  | —       |
| <b>G.13</b>        | <b>Printed boards</b>   |  | P       |
| G.13.1             | General requirements  | See the following details.   | P       |
| G.13.2             | Uncoated printed boards   | The insulation between conductors on the outer surfaces of an uncoated printed board complied with the minimum clearance and creepage requirements | P       |
| G.13.3             | Coated printed boards   | No coated printed board or multilayer board applied for within the equipment.  | N/A     |
| G.13.4             | Insulation between conductors on the same inner surface   |  | N/A     |
|                    | Compliance with cemented joint requirements (Specify construction) .....  |  | —       |

| IEC 62368-1 |   |  |         |
|-------------|---|--|---------|
| Clause      | Requirement + Test  | Result - Remark  | Verdict |
| G.13.5      | Insulation between conductors on different surfaces   |  | N/A     |
|             | Distance through insulation.....:   |  | N/A     |
|             | Number of insulation layers (pcs) .....   |  | —       |
| G.13.6      | Tests on coated printed boards  |  | N/A     |
| G.13.6.1    | Sample preparation and preliminary inspection   |  | N/A     |
| G.13.6.2a)  | Thermal conditioning  |  | N/A     |
| G.13.6.2b)  | Electric strength test  |  | N/A     |
| G.13.6.2c)  | Abrasion resistance test  |  | N/A     |
| <b>G.14</b> | <b>Coating on components terminals</b>  |  | N/A     |
| G.14.1      | Requirements .....  | No coating on component terminals considered to affect creepage or clearances. | N/A     |
| <b>G.15</b> | <b>Liquid filled components</b>   |  | N/A     |
| G.15.1      | General requirements  | No such device provided within the equipment.                                  | N/A     |
| G.15.2      | Requirements  |  | N/A     |
| G.15.3      | Compliance and test methods   |  | N/A     |
| G.15.3.1    | Hydrostatic pressure test   |  | N/A     |
| G.15.3.2    | Creep resistance test   |  | N/A     |
| G.15.3.3    | Tubing and fittings compatibility test  |  | N/A     |
| G.15.3.4    | Vibration test  |  | N/A     |
| G.15.3.5    | Thermal cycling test  |  | N/A     |
| G.15.3.6    | Force test  |  | N/A     |
| G.15.4      | Compliance  |  | N/A     |
| <b>G.16</b> | <b>IC including capacitor discharge function (ICX)</b>  |  | P       |
| a)          | Humidity treatment in accordance with sc5.4.8 – 120 hours   | Approval IC  | P       |
| b)          | Impulse test using circuit 2 with $U_c =$ to transient voltage .....  |  | N/A     |
| C1)         | Application of ac voltage at 110% of rated voltage for 2.5 minutes  |  | N/A     |
| C2)         | Test voltage :  |  | —       |
| D1)         | 10,000 cycles on and off using capacitor with smallest capacitance resistor with largest resistance specified by manufacturer |  | N/A     |
| D2)         | Capacitance .....   |  | —       |
| D3)         | Resistance .....  |  | —       |

| IEC 62368-1 |   |   |         |
|-------------|---|---|---------|
| Clause      | Requirement + Test  | Result - Remark   | Verdict |
| <b>H</b>    | <b>CRITERIA FOR TELEPHONE RINGING SIGNALS</b>                                 |   | N/A     |
| H.1         | General   | No telephone ringing signal generated within the equipment. | N/A     |
| H.2         | Method A  |   | N/A     |
| H.3         | Method B  |   | N/A     |
| H.3.1       | Ringling signal   |   | N/A     |
| H.3.1.1     | Frequency (Hz) .....  |   | —       |
| H.3.1.2     | Voltage (V) .....   |   | —       |
| H.3.1.3     | Cadence; time (s) and voltage (V) .....                                       |   | —       |
| H.3.1.4     | Single fault current (mA): .....  |   | —       |
| H.3.2       | Tripping device and monitoring voltage .....                                  |   | N/A     |
| H.3.2.1     | Conditions for use of a tripping device or a monitoring voltage complied with |   | N/A     |
| H.3.2.2     | Tripping device   |   | N/A     |
| H.3.2.3     | Monitoring voltage (V) .....  |   | —       |

|          |   |   |   |
|----------|---|---|---|
| <b>J</b> | <b>INSULATED WINDING WIRES FOR USE WITHOUT INTERLEAVED INSULATION</b> |   | P |
|          | General requirements  | Approved triple insulated wire used.<br>See appended table 4.1.2. | P |

|          |   |                               |     |
|----------|---|-------------------------------|-----|
| <b>K</b> | <b>SAFETY INTERLOCKS</b>  |                               | N/A |
| K.1      | General requirements  | No safety interlock provided. | N/A |
| K.2      | Components of safety interlock safeguard mechanism .....  |                               | N/A |
| K.3      | Inadvertent change of operating mode  |                               | N/A |
| K.4      | Interlock safeguard override  |                               | N/A |
| K.5      | Fail-safe   |                               | N/A |
|          | Compliance .....  |                               | N/A |
| K.6      | Mechanically operated safety interlocks   |                               | N/A |
| K.6.1    | Endurance requirement   |                               | N/A |
| K.6.2    | Compliance and Test method .....  |                               | N/A |
| K.7      | Interlock circuit isolation   |                               | N/A |
| K.7.1    | Separation distance for contact gaps & interlock circuit elements (type and circuit location) ..... |                               | N/A |
| K.7.2    | Overload test, Current (A) .....  |                               | N/A |

| IEC 62368-1 |                              |                 |         |
|-------------|------------------------------|-----------------|---------|
| Clause      | Requirement + Test           | Result - Remark | Verdict |
| K.7.3       | Endurance test               |                 | N/A     |
| K.7.4       | Electric strength test ..... |                 | N/A     |

| L   | DISCONNECT DEVICES              |  | P   |
|-----|---------------------------------|--|-----|
| L.1 | General requirements            | AC Inlet   | P   |
| L.2 | Permanently connected equipment |  | N/A |
| L.3 | Parts that remain energized     | When AC Inlet is disconnected no hazardous voltage in the equipment. | P   |
| L.4 | Single phase equipment          | The mains inlet disconnects both poles simultaneously.               | P   |
| L.5 | Three-phase equipment           |  | N/A |
| L.6 | Switches as disconnect devices  |  | N/A |
| L.7 | Plugs as disconnect devices     |  | N/A |
| L.8 | Multiple power sources          | Only one a.c. mains connection.                                      | N/A |

| M          | EQUIPMENT CONTAINING BATTERIES AND THEIR PROTECTION CIRCUITS             |                  | N/A |
|------------|--|------------------|-----|
| M.1        | General requirements   | No battery used. | N/A |
| M.2        | Safety of batteries and their cells                                      |                  | N/A |
| M.2.1      | Requirements   |                  | N/A |
| M.2.2      | Compliance and test method (identify method) ..                          |                  | N/A |
| M.3        | Protection circuits  |                  | N/A |
| M.3.1      | Requirements   |                  | N/A |
| M.3.2      | Tests  |                  | N/A |
|            | - Overcharging of a rechargeable battery                                 |                  | N/A |
|            | - Unintentional charging of a non-rechargeable battery                   |                  | N/A |
|            | - Reverse charging of a rechargeable battery                             |                  | N/A |
|            | - Excessive discharging rate for any battery                             |                  | N/A |
| M.3.3      | Compliance .....   |                  | N/A |
| M.4        | Additional safeguards for equipment containing secondary lithium battery |                  | N/A |
| M.4.1      | General  |                  | N/A |
| M.4.2      | Charging safeguards  |                  | N/A |
| M.4.2.1    | Charging operating limits  |                  | N/A |
| M.4.2.2a)  | Charging voltage, current and temperature .....                          |                  | —   |
| M.4.2.2 b) | Single faults in charging circuitry.....                                 |                  | —   |

| <b>IEC 62368-1</b> |   |                 |         |
|--------------------|---|-----------------|---------|
| Clause             | Requirement + Test  | Result - Remark | Verdict |
| M.4.3              | Fire Enclosure  |                 | N/A     |
| M.4.4              | Endurance of equipment containing a secondary lithium battery                           |                 | N/A     |
| M.4.4.2            | Preparation   |                 | N/A     |
| M.4.4.3            | Drop and charge/discharge function tests  |                 | N/A     |
|                    | Drop  |                 | N/A     |
|                    | Charge  |                 | N/A     |
|                    | Discharge   |                 | N/A     |
| M.4.4.4            | Charge-discharge cycle test   |                 | N/A     |
| M.4.4.5            | Result of charge-discharge cycle test   |                 | N/A     |
| M.5                | Risk of burn due to short circuit during carrying                                       |                 | N/A     |
| M.5.1              | Requirement   |                 | N/A     |
| M.5.2              | Compliance and Test Method (Test of P.2.3)  |                 | N/A     |
| M.6                | Prevention of short circuits and protection from other effects of electric current      |                 | N/A     |
| M.6.1              | Short circuits  |                 | N/A     |
| M.6.1.1            | General requirements  |                 | N/A     |
| M.6.1.2            | Test method to simulate an internal fault   |                 | N/A     |
| M.6.1.3            | Compliance (Specify M.6.1.2 or alternative method) .....                                |                 | N/A     |
| M.6.2              | Leakage current (mA) .....  |                 | N/A     |
| M.7                | Risk of explosion from lead acid and NiCd batteries                                     |                 | N/A     |
| M.7.1              | Ventilation preventing explosive gas concentration                                      |                 | N/A     |
| M.7.2              | Compliance and test method  |                 | N/A     |
| M.8                | Protection against internal ignition from external spark sources of lead acid batteries |                 | N/A     |
| M.8.1              | General requirements  |                 | N/A     |
| M.8.2              | Test method   |                 | N/A     |
| M.8.2.1            | General requirements  |                 | N/A     |
| M.8.2.2            | Estimation of hypothetical volume $V_z$ (m <sup>3</sup> /s).....                        |                 | —       |
| M.8.2.3            | Correction factors .....  |                 | —       |
| M.8.2.4            | Calculation of distance $d$ (mm) .....  |                 | —       |
| M.9                | Preventing electrolyte spillage   |                 | N/A     |
| M.9.1              | Protection from electrolyte spillage  |                 | N/A     |
| M.9.2              | Tray for preventing electrolyte spillage  |                 | N/A     |

| IEC 62368-1 |  |                 |         |
|-------------|--|-----------------|---------|
| Clause      | Requirement + Test   | Result - Remark | Verdict |
| M.10        | Instructions to prevent reasonably foreseeable misuse (Determination of compliance: inspection, data review; or abnormal testing) .... |                 | N/A     |

|          |                                   |                     |     |
|----------|-----------------------------------|---------------------|-----|
| <b>N</b> | <b>ELECTROCHEMICAL POTENTIALS</b> |                     | N/A |
|          | Metal(s) used.....                | Class II equipment. | —   |

|          |   |             |   |
|----------|---|-------------|---|
| <b>O</b> | <b>MEASUREMENT OF CREEPAGE DISTANCES AND CLEARANCES</b> |             | P |
|          | Figures O.1 to O.20 of this Annex applied .....         | Considered. | — |

|          |   |                           |     |
|----------|---|---------------------------|-----|
| <b>P</b> | <b>SAFEGUARDS AGAINST ENTRY OF FOREIGN OBJECTS AND SPILLAGE OF INTERNAL LIQUIDS</b>   |                           | P   |
| P.1      | General requirements  |                           | N/A |
| P.2.2    | Safeguards against entry of foreign object  | No openings of enclosure. | N/A |
|          | Location and Dimensions (mm) .....  |                           | —   |
| P.2.3    | Safeguard against the consequences of entry of foreign object   |                           | N/A |
| P.2.3.1  | Safeguards against the entry of a foreign object  |                           | N/A |
|          | Openings in transportable equipment   |                           | N/A |
|          | Transportable equipment with metalized plastic parts .....  |                           | N/A |
| P.2.3.2  | Openings in transportable equipment in relation to metallized parts of a barrier or enclosure (identification of supplementary safeguard) ..... |                           | N/A |
| P.3      | Safeguards against spillage of internal liquids   | No such liquids.          | N/A |
| P.3.1    | General requirements  |                           | N/A |
| P.3.2    | Determination of spillage consequences  |                           | N/A |
| P.3.3    | Spillage safeguards   |                           | N/A |
| P.3.4    | Safeguards effectiveness  |                           | N/A |
| P.4      | Metallized coatings and adhesive securing parts   | No such construction.     | N/A |
| P.4.2 a) | Conditioning testing  |                           | N/A |
|          | Tc (°C) .....   |                           | —   |
|          | Tr (°C) .....   |                           | —   |
|          | Ta (°C) .....   |                           | —   |
| P.4.2 b) | Abrasion testing .....  |                           | N/A |
| P.4.2 c) | Mechanical strength testing .....   |                           | N/A |



| IEC 62368-1 |                    |                 |         |
|-------------|--------------------|-----------------|---------|
| Clause      | Requirement + Test | Result - Remark | Verdict |

| <b>Q</b> | <b>CIRCUITS INTENDED FOR INTERCONNECTION WITH BUILDING WIRING</b>                               |   | <b>P</b> |
|----------|---|---|----------|
| Q.1      | Limited power sources   | See appended table Annex Q.1              | N/A      |
| Q.1.1 a) | Inherently limited output   |   | N/A      |
| Q.1.1 b) | Impedance limited output  |   | N/A      |
|          | - Regulating network limited output under normal operating and simulated single fault condition |   | P        |
| Q.1.1 c) | Overcurrent protective device limited output  |   | N/A      |
| Q.1.1 d) | IC current limiter complying with G.9   |   | N/A      |
| Q.1.2    | Compliance and test method  | See appended table Annex Q.1              | P        |
| Q.2      | Test for external circuits – paired conductor cable   | No such circuit for connection to the EUT | N/A      |
|          | Maximum output current (A) .....  |   | —        |
|          | Current limiting method .....   |   | —        |

| <b>R</b> | <b>LIMITED SHORT CIRCUIT TEST</b>                                   |                        | <b>N/A</b> |
|----------|---|------------------------|------------|
| R.1      | General requirements  | No such consideration. | N/A        |
| R.2      | Determination of the overcurrent protective device and circuit      |                        | N/A        |
| R.3      | Test method Supply voltage (V) and short-circuit current (A). ..... |                        | N/A        |

| <b>S</b> | <b>TESTS FOR RESISTANCE TO HEAT AND FIRE</b>   |  | <b>P</b> |
|----------|--|--|----------|
| S.1      | Flammability test for fire enclosures and fire barrier materials of equipment where the steady state power does not exceed 4 000 W | Approved fire enclosure with V-0 or V-0 material used. | P        |
|          | Samples, material .....  |  | —        |
|          | Wall thickness (mm) .....  |  | —        |
|          | Conditioning (°C) .....  |  | —        |
|          | Test flame according to IEC 60695-11-5 with conditions as set out  |  | N/A      |
|          | - Material not consumed completely   |  | N/A      |
|          | - Material extinguishes within 30s   |  | N/A      |
|          | - No burning of layer or wrapping tissue   |  | N/A      |
| S.2      | Flammability test for fire enclosure and fire barrier integrity  |  | N/A      |
|          | Samples, material .....  |  | —        |
|          | Wall thickness (mm) .....  |  | —        |

| <b>IEC 62368-1</b> |  |                       |         |
|--------------------|--|-----------------------|---------|
| Clause             | Requirement + Test   | Result - Remark       | Verdict |
|                    | Conditioning (°C) .....  |                       | —       |
|                    | Test flame according to IEC 60695-11-5 with conditions as set out  |                       | N/A     |
|                    | Test specimen does not show any additional hole  |                       | N/A     |
| S.3                | Flammability test for the bottom of a fire enclosure   |                       | N/A     |
|                    | Samples, material .....  |                       | —       |
|                    | Wall thickness (mm) .....  |                       | —       |
|                    | Cheesecloth did not ignite   |                       | N/A     |
| S.4                | Flammability classification of materials   | See Table 4.1.2 only. | P       |
| S.5                | Flammability test for fire enclosures and fire barrier materials of equipment where the steady state power does not exceed 4 000 W |                       | N/A     |
|                    | Samples, material .....  |                       | —       |
|                    | Wall thickness (mm) .....  |                       | —       |
|                    | Conditioning (test condition), (°C).....   |                       | —       |
|                    | Test flame according to IEC 60695-11-20 with conditions as set out   |                       | N/A     |
|                    | After every test specimen was not consumed completely  |                       | N/A     |
|                    | After fifth flame application, flame extinguished within 1 min   |                       | N/A     |

| <b>T</b> | <b>MECHANICAL STRENGTH TESTS</b> |                          | <b>P</b> |
|----------|----------------------------------|--------------------------|----------|
| T.1      | General requirements             |                          | P        |
| T.2      | Steady force test, 10 N .....    | (See appended table T.2) | P        |
| T.3      | Steady force test, 30 N .....    |                          | N/A      |
| T.4      | Steady force test, 100 N .....   | (See appended table T.4) | P        |
| T.5      | Steady force test, 250 N .....   | (See appended table T.5) | P        |
| T.6      | Enclosure impact test            | Desktop type             | P        |
|          | Fall test                        |                          | N/A      |
|          | Swing test                       |                          | N/A      |
| T.7      | Drop test .....                  | (See appended table T.7) | N/A      |
| T.8      | Stress relief test.....          | (See appended table T.8) | P        |
| T.9      | Impact Test (glass)              | No glass used.           | N/A      |
| T.9.1    | General requirements             |                          | N/A      |

| <b>IEC 62368-1</b> |   |   |         |
|--------------------|---|---|---------|
| Clause             | Requirement + Test  | Result - Remark                                   | Verdict |
| T.9.2              | Impact test and compliance  |   | N/A     |
|                    | Impact energy (J) .....   |   | —       |
|                    | Height (m) .....  |   | —       |
| T.10               | Glass fragmentation test .....  |   | N/A     |
| T.11               | Test for telescoping or rod antennas  | No such device.                                   | N/A     |
|                    | Torque value (Nm) .....   |   | —       |
| <b>U</b>           | <b>MECHANICAL STRENGTH OF CATHODE RAY TUBES (CRT) AND PROTECTION AGAINST THE EFFECTS OF IMPLOSION</b> |   | N/A     |
| U.1                | General requirements  | No CRT provided.                                  | N/A     |
| U.2                | Compliance and test method for non-intrinsically protected CRTs                                       |   | N/A     |
| U.3                | Protective Screen .....   |   | N/A     |
| <b>V</b>           | <b>DETERMINATION OF ACCESSIBLE PARTS (FINGERS, PROBES AND WEDGES)</b>                                 |   | P       |
| V.1                | Accessible parts of equipment   | No access with test probes to any hazardous parts | P       |
| V.2                | Accessible part criterion   |   | P       |

| IEC 62368-1 |                    |                 |         |
|-------------|--------------------|-----------------|---------|
| Clause      | Requirement + Test | Result - Remark | Verdict |

| 4.1.2                      | TABLE: List of critical components |                      |   |   |   | P |
|----------------------------|------------------------------------|----------------------|---|---|---|---|
| Object/part No.            | Manufacturer/<br>trademark         | Type/model           | Technical data  | Standard<br>(Edition / year)  | Mark(s) of<br>conformity <sup>1)</sup>        |   |
| Enclosure                  | SABIC<br>INNOVATIVE<br>PLASTICS    | 500(f2), 500R(f2)    | Lexan, Rated 120°C,<br>minimum 1.5mm<br>thick rated V-0 | UL 94,<br>UL 746C   | UL E207780<br>E45329                          |   |
| -(alternative)             | SABIC<br>INNOVATIVE<br>PLASTICS    | 940A, 940(f1)        | Lexan, Rated 120°C,<br>minimum 1.5mm<br>thick rated V-0 | UL 94,<br>UL 746C   | UL E207780<br>E45329                          |   |
| -(alternative)             | SABIC<br>INNOVATIVE<br>PLASTICS    | 945(GG),<br>945U(GG) | Lexan, Rated 120°C,<br>minimum 1.5mm<br>thick rated V-0 | UL 94,<br>UL 746C   | UL E207780<br>E45329                          |   |
| AC input<br>connector (P1) | TECX-UNIONS<br>TECHNOLOGY          | SO-222 series        | Rated 250Vac, 2.5A,<br>C8                               | ANSI/UL498<br>ANSI/UL 60320-<br>1<br>CAN/CSA-<br>C22.2 No.<br>60320-1<br>EN 60320-1 | UL: E220004<br>VDE:<br>40020337<br>ENEC 00636 |   |
| (alternative)              | RONG FENG<br>INDUSTRIAL<br>CO LTD  | RF-180 series        | Rated 250Vac, 2.5A,<br>C8                               | ANSI/UL498<br>ANSI/UL 60320-<br>1<br>CAN/CSA-<br>C22.2 No.<br>60320-1<br>EN 60320-1 | UL: E102641<br>VDE:<br>40030168               |   |
| Fuse<br>(F1)               | LITTELFUSE<br>WICKMANN<br>WERKE    | 392 series           | 250Vac, T2A,  | ANSI/UL248-1,<br>CSA-C22.2 No.<br>248-1-00<br>IEC/EN 60127-1<br>IEC/EN 60127-3      | UL E67006<br>VDE 126983                       |   |
| (alternative)              | BEL FUSE INC                       | RST series           | 250Vac, T2A,  | ANSI/UL248-1,<br>CSA-C22.2 No.<br>248-1-00<br>IEC/EN 60127-1<br>IEC/EN 60127-3      | UL E20624<br>VDE<br>40011144                  |   |
| (alternative)              | WALTER<br>ELECTRONIC<br>CO LTD     | 2010 series          | 250Vac, T2A,  | ANSI/UL248-1,<br>CSA-C22.2 No.<br>248-1-00<br>IEC/EN 60127-1<br>IEC/EN 60127-3      | UL E56092<br>VDE<br>40018781                  |   |

| IEC 62368-1 |                    |                 |         |
|-------------|--------------------|-----------------|---------|
| Clause      | Requirement + Test | Result - Remark | Verdict |

| Object/part No.     | Manufacturer/<br>trademark         | Type/model            | Technical data   | Standard<br>(Edition / year)   | Mark(s) of<br>conformity <sup>1)</sup> |
|---------------------|------------------------------------|-----------------------|--|--|--|
| (alternative)       | CONQUER<br>ELECTRONICS<br>CO LTD   | MST series            | 250Vac, T2A,   | ANSI/UL248-1,<br>CSA-C22.2 No.<br>248-1-00<br>IEC/EN 60127-1<br>IEC/EN 60127-3 | UL E82636<br>VDE<br>40017118           |
| IC (U2)             | NXP<br>Semiconductors              | TEA18362              | 90-264V AC, 47-<br>63Hz Overvoltage<br>Category II   | IEC 62368-1  | CB: DK-<br>40437-UL                    |
| Optocoupler<br>(U3) | VISHAY                             | TCET1107<br>TCET1107G | Rated isolation<br>5000Vac, 110°C,<br>Clearances and<br>Creepage distance:<br>≥8.0mm<br>Isolation thickness<br>between input and<br>output: ≥0.4mm | IEC/EN 60950-1<br>UL1577,<br>IEC/EN 60747-<br>5-5                              | UL: E52744<br>VDE:<br>40028080         |
| (alternative)       | LITE-ON<br>TECHNOLOGY<br>CORP      | LTV-817<br>LTV-817M   | Rated isolation<br>5000Vac, 110°C.<br>Clearances and<br>Creepage distance:<br>≥8.0mm<br>Isolation thickness<br>between input and<br>output: ≥0.4mm | IEC/EN 60950-1<br>UL1577<br>IEC/EN 60747-<br>5-5                               | UL: E113898<br>VDE:<br>40015248        |
| (alternative)       | SHARP                              | PC123                 | Rated isolation<br>5000Vac, 100°C.<br>Clearances and<br>Creepage distance:<br>≥8.0mm<br>Isolation thickness<br>between input and<br>output: ≥0.4mm | IEC/EN 60950-1<br>UL 1577,<br>IEC/EN 60747-<br>5-5                             | UL: E64380<br>VDE: 400080<br>87        |
| (alternative)       | EVERLIGHT<br>ELECTRONICS<br>CO LTD | EL817M                | Rated isolation<br>5000Vac, 100°C.<br>Clearances and<br>Creepage distance:<br>≥8.0mm<br>Isolation thickness<br>between input and<br>output: ≥0.4mm | UL1577,<br>IEC/EN 60747-<br>5-5  | UL: E214129<br>VDE: 132249             |

| IEC 62368-1 |                    |                 |         |
|-------------|--------------------|-----------------|---------|
| Clause      | Requirement + Test | Result - Remark | Verdict |

| Object/part No.       | Manufacturer/<br>trademark               | Type/model            | Technical data                             | Standard<br>(Edition / year)                                      | Mark(s) of<br>conformity <sup>1)</sup> |
|-----------------------|--|-----------------------|--|---|--|
| Y Capacitors<br>(CY1) | VISHAY<br>ELECTRONIC<br>GMBH             | 440L                  | Max. 1000pF,<br>250Vac, 125°C,<br>Class Y1 | ANSI/UL60384-<br>14, CAN/CSA-<br>E60384-14<br>IEC/EN 60384-<br>14 | UL: E99264<br>VDE:400039<br>85         |
| (alternative)         | VISHAY<br>ELECTRONIC<br>GMBH             | VY1                   | Max. 1000pF,<br>250Vac, 125°C,<br>Class Y1 | ANSI/UL60384-<br>14, CAN/CSA-<br>E60384-14<br>IEC/EN 60384-<br>14 | UL E183844<br>VDE:<br>40012673         |
| (alternative)         | TDK-EPC<br>CORPORATION                   | CD                    | Max. 1000pF,<br>250Vac, 125°C,<br>Class Y1 | ANSI/UL60384-<br>14, CAN/CSA-<br>E60384-14<br>IEC/EN 60384-<br>14 | UL:E37861<br>VDE:124321                |
| (alternative)         | MURATA MFG<br>CO LTD                     | KX                    | Max. 1000pF,<br>250Vac, 125°C,<br>Class Y1 | ANSI/UL60384-<br>14, CAN/CSA-<br>E60384-14<br>IEC/EN 60384-<br>14 | UL: E37921<br>VDE:124321               |
| X Capacitor<br>(C3)   | KEMET<br>ELECTRONICS                     | R.46                  | Max. 0.33µF, 275V,<br>110°C, Class X2      | ANSI/UL60384-<br>14, CAN/CSA-<br>E60384-14<br>IEC/EN 60384-<br>14 | UL:E97797<br>ENEC:<br>V4413            |
| (alternative)         | XIAMEN<br>FARATRONIC<br>CO LTD           | MKP62                 | Max. 0.33µF, 275V,<br>110°C, Class X2      | ANSI/UL60384-<br>14, CAN/CSA-<br>E60384-14<br>IEC/EN 60384-<br>14 | UL:E186600<br>VDE:400003<br>58         |
| (alternative)         | EPCOS<br>ELECTRONIC<br>COMPONENTS<br>S A | B3292#<br>(#any word) | Max. 0.33µF, 275V,<br>110°C, Class X2      | ANSI/UL60384-<br>14, CAN/CSA-<br>E60384-14<br>IEC/EN 60384-<br>14 | UL: E97863<br>VDE:400055<br>24         |
| (alternative)         | CARLI<br>ELECTRONICS<br>CO LTD           | MPX                   | Max. 0.33µF, 275V,<br>110°C, Class X2      | ANSI/UL60384-<br>14, CAN/CSA-<br>E60384-14<br>IEC/EN 60384-<br>14 | UL: E120045<br>VDE:400085<br>20        |

| IEC 62368-1 |                    |                 |         |
|-------------|--------------------|-----------------|---------|
| Clause      | Requirement + Test | Result - Remark | Verdict |

| Object/part No.  | Manufacturer/<br>trademark          | Type/model   | Technical data                        | Standard<br>(Edition / year)                                      | Mark(s) of<br>conformity <sup>1)</sup> |
|------------------|-------------------------------------|--|---------------------------------------|---|--|
| (alternative)    | OKAYA<br>ELECTRIC                   | RE series  | Max. 0.33µF, 275V,<br>110°C, Class X2 | ANSI/UL60384-<br>14, CAN/CSA-<br>E60384-14<br>IEC/EN 60384-<br>14 | UL: E47474<br>VDE:400286<br>57         |
| Inductor<br>(L1) | SHENZHEN<br>HIGHLIGHT<br>ELECTRONIC | 97660-479-aaa<br>(a=0-9, A-z or<br>blank, represent<br>for manufacturer<br>code) | Rated 130°C, 8.7µH                    | IEC 62368-1   | Tested with<br>appliance               |
| (Alternate)      | SHENZHEN<br>JINGQUANHUA             | 97660-479-aaa<br>(a=0-9, A-z or<br>blank, represent<br>for manufacturer<br>code) | Rated 130°C, 8.7µH                    | IEC 62368-1   | Tested with<br>appliance               |
| (Alternate)      | CLICK<br>TECHNOLOGY                 | 97660-479-aaa<br>(a=0-9, A-z or<br>blank, represent<br>for manufacturer<br>code) | Rated 130°C, 8.7µH                    | IEC 62368-1   | Tested with<br>appliance               |
| (Alternate)      | RONG CHYUAN<br>TECHNOLOGY           | 97660-479-aaa<br>(a=0-9, A-z or<br>blank, represent<br>for manufacturer<br>code) | Rated 130°C, 8.7µH                    | IEC 62368-1   | Tested with<br>appliance               |
| Inductor<br>(L2) | SHENZHEN<br>HIGHLIGHT<br>ELECTRONIC | 97661-586-aaa<br>(a=0-9, A-z or<br>blank, represent<br>for manufacturer<br>code) | Rated 130°C, 17mH                     | IEC 62368-1   | Tested with<br>appliance               |
| (Alternate)      | SHENZHEN<br>JINGQUANHUA             | 97661-586-aaa<br>(a=0-9, A-z or<br>blank, represent<br>for manufacturer<br>code) | Rated 130°C, 17mH                     | IEC 62368-1   | Tested with<br>appliance               |
| (Alternate)      | CLICK<br>TECHNOLOGY                 | 97661-586-aaa<br>(a=0-9, A-z or<br>blank, represent<br>for manufacturer<br>code) | Rated 130°C, 17mH                     | IEC 62368-1   | Tested with<br>appliance               |

| IEC 62368-1 |                    |                 |         |
|-------------|--------------------|-----------------|---------|
| Clause      | Requirement + Test | Result - Remark | Verdict |

| Object/part No.     | Manufacturer/<br>trademark          | Type/model   | Technical data  | Standard<br>(Edition / year)  | Mark(s) of<br>conformity <sup>1)</sup> |
|---------------------|-------------------------------------|--|---|---|--|
| (Alternate)         | RONG CHYUAN<br>TECHNOLOGY           | 97661-586-aaa<br>(a=0-9, A-z or<br>blank, represent<br>for manufacturer<br>code) | Rated 130°C, 17mH   | IEC 62368-1   | Tested with<br>appliance               |
| Transformer<br>(T1) | SHENZHEN<br>HIGHLIGHT<br>ELECTRONIC | 1) 97660-476-aaa   | Pri. Winding:<br>N1 (Pin 2-3), N6 (Pin<br>3-6):<br>Φ0.40mmx2Px20Ts<br>N2: (Pin 4-5):<br>Φ0.13mmx2Px7Ts<br>N3 (Pin 5-NC1),<br>N5 (Pin 5-NC2):<br>Φ0.13mmx3Px22Ts<br>Sec. Winding:<br>N4 (Pin A-B):<br>Φ0.17mm*7Cx4Px6<br>Ts<br>Class B | Applicable part<br>of IEC/EN<br>62368-1 and<br>according to<br>IEC/EN 60085 | Tested with<br>appliance               |
| (alternative)       | SHENZHEN<br>JINGQUANHUA             |  |   |   |  |
| (alternative)       | CLICK<br>TECHNOLOGY                 |  |   |   |  |
| (alternative)       | RONG CHYUAN<br>TECHNOLOGY           |  |   |   |  |
| (alternative)       | SHENZHEN<br>HIGHLIGHT<br>ELECTRONIC | 2) 97660-487-aaa   | N1 (Pin 2-3), N6 (Pin<br>3-6):<br>Φ0.40mmx2Px22Ts<br>N2: (Pin 4-5):<br>Φ0.13mmx2Px8Ts<br>N3 (Pin 5-NC1),<br>N5 (Pin 5-NC2):<br>Φ0.13mmx3Px22Ts<br>Sec. Winding:<br>N4 (Pin A-B):<br>Φ0.17mm*7Cx3Px8<br>Ts<br>Class B                  | Applicable part<br>of IEC/EN<br>62368-1 and<br>according to<br>IEC/EN 60085 | Tested with<br>appliance               |
| (alternative)       | SHENZHEN<br>JINGQUANHUA             |  |   |   |  |
| (alternative)       | CLICK<br>TECHNOLOGY                 |  |   |   |  |
| (alternative)       | RONG CHYUAN<br>TECHNOLOGY           |  |   |   |  |



| IEC 62368-1 |                    |                 |         |
|-------------|--------------------|-----------------|---------|
| Clause      | Requirement + Test | Result - Remark | Verdict |

| Object/part No.                   | Manufacturer/<br>trademark          | Type/model       | Technical data   | Standard<br>(Edition / year)  | Mark(s) of<br>conformity <sup>1)</sup> |
|-----------------------------------|-------------------------------------|------------------|--|---|--|
| (alternative)                     | SHENZHEN<br>HIGHLIGHT<br>ELECTRONIC | 3) 97660-488-aaa | N1 (Pin 2-3), N6 (Pin 3-6):<br>Φ0.40mmx2Px22Ts<br>N2: (Pin 4-5):<br>Φ0.13mmx2Px7Ts<br>N3 (Pin 5-NC1),<br>N5 (Pin 5-NC2):<br>Φ0.13mmx3Px22Ts<br>Sec. Winding:<br>N4 (Pin TA-TB):<br>Φ0.24mm*7Cx2Px9<br>Ts<br>Class B  | Applicable part<br>of IEC/EN<br>62368-1 and<br>according to<br>IEC/EN 60085 | Tested with<br>appliance               |
| (alternative)                     | SHENZHEN<br>JINGQUANHUA             |                  |  |   |  |
| (alternative)                     | CLICK<br>TECHNOLOGY                 |                  |  |   |  |
| (alternative)                     | RONG CHYUAN<br>TECHNOLOGY           |                  |  |   |  |
| (alternative)                     | SHENZHEN<br>HIGHLIGHT<br>ELECTRONIC | 4) 97660-477-aaa | N1 (Pin 2-3), N6 (Pin 3-6):<br>Φ0.40mmx2Px22Ts<br>N2: (Pin 4-5):<br>Φ0.13mmx2Px7Ts<br>N3 (Pin 5-NC1),<br>N5 (Pin 5-NC2):<br>Φ0.13mmx3Px22Ts<br>Sec. Winding:<br>N4 (Pin TA-TB):<br>Φ0.17mm*7Cx2Px1<br>2Ts<br>Class B | Applicable part<br>of IEC/EN<br>62368-1 and<br>according to<br>IEC/EN 60085 | Tested with<br>appliance               |
| (alternative)                     | SHENZHEN<br>JINGQUANHUA             |                  |  |   |  |
| (alternative)                     | CLICK<br>TECHNOLOGY                 |                  |  |   |  |
| (alternative)                     | RONG CHYUAN<br>TECHNOLOGY           |                  |  |   |  |
| Components used in Transformer T1 |                                     |                  |  |   |  |
| - Bobbin                          | SUMITOMO<br>BAKELITE CO<br>LTD      | PM-9820          | V-0, 150°C, Min.<br>thickness 0.50mm   | UL 94,<br>UL 746C   | UL: E41429                             |
| -(alternative)                    | SUMITOMO<br>BAKELITE CO<br>LTD      | PM-9830          | V-0, 150°C, Min.<br>thickness 0.50mm   | UL 94,<br>UL 746C   | UL: E41429                             |
| -(alternative)                    | SUMITOMO<br>BAKELITE CO<br>LTD      | PM-9630          | V-0, 150°C, Min.<br>thickness 0.50mm   | UL 94,<br>UL 746C   | UL: E41429                             |
| -(alternative)                    | SUMITOMO<br>BAKELITE CO<br>LTD      | PM-9720          | V-0, 150°C, Min.<br>thickness 0.50mm   | UL 94,<br>UL 746C   | UL: E41429                             |
| -(alternative)                    | CHANG CHUN<br>PLASTICS              | T375J            | V-0, 150°C, Min.<br>thickness 0.50mm   | UL 94,<br>UL 746C   | UL: E59481                             |

| IEC 62368-1 |                    |                 |         |
|-------------|--------------------|-----------------|---------|
| Clause      | Requirement + Test | Result - Remark | Verdict |

| Object/part No.               | Manufacturer/<br>trademark                                 | Type/model  | Technical data                                     | Standard<br>(Edition / year)          | Mark(s) of<br>conformity <sup>1)</sup>   |
|-------------------------------|--|---|--|---------------------------------------|--|
| -Windings for T1<br>Primary   | Interchangeable  | MW-28,<br>MW75C, MW75-C<br>UEW,UEWB,<br>UEW/U, UEWN/U,<br>2UEW-B, xUEW-<br>NY | Copper magnet wire,<br>minimum 130 °C              | UL 1446                               | UL approval                              |
| -Windings for T1<br>Secondary | TOTOKU<br>ELECTRIC CO<br>LTD                               | TIW-2<br>TIW-2LZ  | Triple insulated wire,<br>rated minimum<br>130°C   | ANSI/UL 60950-<br>1<br>IEC/EN 62368-1 | UL E166483<br>VDE:<br>40051990           |
| -(alternative)                | TOTOKU<br>ELECTRIC CO<br>LTD                               | TIW-3<br>TIW-3LZ  | Triple insulated wire,<br>rated minimum 130<br>°C  | ANSI/UL 60950-<br>1<br>IEC/EN 62368-1 | UL E166483<br>VDE:<br>40051888           |
| -(alternative)                | FURUKAWA<br>ELECTRIC CO<br>LTD                             | TEX-ELZ<br>TEX-E  | Triple insulated wire,<br>rated minimum 130<br>°C. | ANSI/UL 60950-<br>1<br>IEC/EN 62368-1 | UL E206440<br>VDE:<br>40032438<br>006735 |
| -Tape                         | P LEO & CO (B<br>C) LTD                                    | 1P801,<br>1P802,<br>1K7170  | 130°C  | UL510                                 | UL: E126174                              |
| -(alternative)                | 3M COMPANY   | 1350F-1,<br>1350T-1,<br>56, 1205,1298   | 130°C  | UL510                                 | UL: E17385                               |
| -(alternative)                | JINGJIANG<br>YAHUA<br>PRESSURE<br>SENSITIVE<br>GLUE CO LTD | CT, WF, PZ  | 130°C  | UL510                                 | UL E165111                               |
| -(alternative)                | SYMBIO INC   | 35660,MY9Y  | 130°C  | UL510                                 | UL: E50292                               |
| -Teflon Tube                  | GREAT<br>HOLDING<br>INDUSTRIAL<br>CO LTD                   | TFL, TFT,<br>TFS  | 200°C Min.   | UL224                                 | UL: E156256                              |
| -(alternative)                | ZEUS<br>INDUSTRIAL<br>PRODUCTS INC                         | TFE-TW-300  | 200°C Min.   | UL224                                 | UL: E64007                               |
| -(alternative)                | CHANGYUAN<br>ELECTRONICS<br>(SHENZHEN)<br>CO LTD           | CB-TT-S<br>CB-TT-L  | 200°C Min.   | UL224                                 | UL: E180908                              |

| IEC 62368-1 |                    |                 |         |
|-------------|--------------------|-----------------|---------|
| Clause      | Requirement + Test | Result - Remark | Verdict |

| Object/part No.        | Manufacturer/<br>trademark                                      | Type/model                    | Technical data  | Standard<br>(Edition / year) | Mark(s) of<br>conformity <sup>1)</sup> |
|------------------------|---|-------------------------------|---|------------------------------|--|
| -Varnish               | ELANTAS<br>ELECTRICAL<br>INSULATION<br>ELANTAS PDG<br>INC       | 468-2(x),<br>V1630FS<br>V1380 | 130°C   | UL 1446                      | UL: E75225                             |
| -(alternative)         | KYOCERA<br>CHEMICAL<br>CORP                                     | TVB2180T++                    | 130°C   | UL 1446                      | UL: E83702                             |
| -(alternative)         | JOHN C DOLPH<br>CO  | B-346A                        | 130°C   | UL 1446                      | UL: E317427                            |
| PCB                    | DONGGUAN<br>MARK WORLD<br>ELECTRONIC<br>TECHNOLOGIE<br>S CO LTD | MW-D-01                       | V-0, 130°C  | UL796<br>UL94                | UL E257174                             |
| (alternative)          | Interchangeable   | Interchangeable               | Min. V-1, min 130°C   | UL796<br>UL94                | UL approval                            |
| Heatsink (HS1)         | Interchangeable   | Interchangeable               | Approximately<br>40.6mm X 22.1mm,<br>1.6mm thick<br>aluminum                    | --                           | Test with<br>appliance                 |
| Heat sink (HS2)        | Interchangeable   | Interchangeable               | L shaped<br>Approximately<br>23.5mm X 4.5mm X<br>22mm, 1.5mm thick,<br>aluminum | --                           | Test with<br>appliance                 |
| Output Wire            | Interchangeable   | Interchangeable               | Rated minimum<br>80°C, VW-1, minimum<br>20AWG                                   | UL758                        | UL approval                            |
| Bulk capacitor<br>(C1) | Interchangeable   | Interchangeable               | Min. 400V, 68µF to<br>150µF, 105°C  | --                           | Test with<br>appliance                 |
| Bridge diode<br>(BD1)  | Interchangeable   | Interchangeable               | Rated Min. 600V,<br>Min. 2A   | --                           | Test with<br>appliance                 |
| Mosfet (Q2)            | Interchangeable   | Interchangeable               | Min 600V, Min 10A   | --                           | Test with<br>appliance                 |

**Supplementary information:**

<sup>1)</sup> Provided evidence ensures the agreed level of compliance. See OD-CB2039.

| IEC 62368-1 |                    |                 |         |
|-------------|--------------------|-----------------|---------|
| Clause      | Requirement + Test | Result - Remark | Verdict |

|  |   |   |                                   |
|--|---|---|-----------------------------------|
| 4.8.4, 4.8.5   | <b>TABLE: Lithium coin/button cell batteries mechanical tests</b> |   | N/A                               |
| <b>(The following mechanical tests are conducted in the sequence noted.)</b> |   |   |                                   |
| 4.8.4.2  | <b>TABLE: Stress Relief test</b>                                  |   | —                                 |
| <b>Part</b>  | <b>Material</b>   | <b>Oven Temperature (°C)</b>              | <b>Comments</b>                   |
| --   | --  | --  | --                                |
| 4.8.4.3  | <b>TABLE: Battery replacement test</b>                            |   | —                                 |
| Battery part no. ....  |   |   | —                                 |
| <b>Battery Installation/withdrawal</b>                                       |   | <b>Battery Installation/Removal Cycle</b> | <b>Comments</b>                   |
|  |   | 1   | --                                |
|  |   | 2   | --                                |
|  |   | 3   | --                                |
|  |   | 4   | --                                |
|  |   | 5   | --                                |
|  |   | 6   | --                                |
|  |   | 8   | --                                |
|  |   | 9   | --                                |
|  |   | 10  | --                                |
| 4.8.4.4  | <b>TABLE: Drop test</b>   |   | —                                 |
| <b>Impact Area</b>   | <b>Drop Distance</b>  | <b>Drop No.</b>                           | <b>Observations</b>               |
| --   | --  | 1   | --                                |
| --   | --  | 2   | --                                |
| --   | --  | 3   | --                                |
| 4.8.4.5  | <b>TABLE: Impact</b>  |   | —                                 |
| <b>Impacts per surface</b>   | <b>Surface tested</b>   | <b>Impact energy (Nm)</b>                 | <b>Comments</b>                   |
| --   | --  | --  | --                                |
| 4.8.4.6  | <b>TABLE: Crush test</b>  |   | —                                 |
| <b>Test position</b>   | <b>Surface tested</b>   | <b>Crushing Force (N)</b>                 | <b>Duration force applied (s)</b> |
| --   | --  | --  | --                                |
| Supplementary information: <b>Not Lithium coin/button cell batteries</b>     |   |   |                                   |

|                            |   |                  |                                   |
|----------------------------|---|------------------|-----------------------------------|
| 4.8.5                      | <b>TABLE: Lithium coin/button cell batteries mechanical test result</b> |                  | N/A                               |
| <b>Test position</b>       | <b>Surface tested</b>   | <b>Force (N)</b> | <b>Duration force applied (s)</b> |
| --                         | --  | --               | --                                |
| Supplementary information: |   |                  |                                   |

| IEC 62368-1 |                    |                 |         |
|-------------|--------------------|-----------------|---------|
| Clause      | Requirement + Test | Result - Remark | Verdict |

| 5.2   |                  | Table: Classification of electrical energy sources   |                                     |                    |   |    | P        |
|---|------------------|--|-------------------------------------|--------------------|---|----|----------|
| 5.2.2.2 – Steady State Voltage and Current conditions |                  |  |                                     |                    |   |    |          |
| No.   | Supply Voltage   | Location (e.g. circuit designation)                  | Test conditions <sup>1)</sup>       | Parameters         |   |    | ES Class |
|   |                  |  |                                     | U<br>(Vrms or Vpk) | I<br>(A <sub>pk</sub> or A <sub>rms</sub> ) | Hz |          |
| 1   | 264Va.c,<br>60Hz | Output (for U measure, '+' to '-' ( FWE050012B)      | Normal                              | 11.83 Vdc          | --  | -- | ES1      |
|   |                  |  | Abnormal (as table B.3)             | 11.75Vdc           | --  | -- |          |
|   |                  |  | Single fault – SC/OC (as table B.4) | 11.83Vdc           | --  | -- |          |
|   | 264Va.c,<br>60Hz | Output (for U measure, '+'/'-' to earth( FWE050012B) | Normal                              | --                 | 0.121mA <sub>peak</sub>                     | -- |          |
|   |                  |  | Abnormal (as table B.3)             | --                 | 0.121mA <sub>peak</sub>                     | -- |          |
|   |                  |  | Single fault – SC/OC (as table B.4) | --                 | 0.122mA <sub>peak</sub>                     | -- |          |
|   | 264Va.c,<br>60Hz | Output (for U measure, '+' to '-' ( FWE050024B)      | Normal                              | 24.22 Vdc          | --  | -- |          |
|   |                  |  | Abnormal (as table B.3)             | 24.16Vdc           | --  | -- |          |
|   |                  |  | Single fault – SC/OC (as table B.4) | 24.22Vdc           | --  | -- |          |
|   | 264Va.c,<br>60Hz | Output (for U measure, '+'/'-' to earth( FWE050024B) | Normal                              | --                 | 0.121mA <sub>peak</sub>                     | -- |          |
|   |                  |  | Abnormal (as table B.3)             | --                 | 0.121mA <sub>peak</sub>                     | -- |          |
|   |                  |  | Single fault – SC/OC (as table B.4) | --                 | 0.122mA <sub>peak</sub>                     | -- |          |
| 2   | 264Va.c,<br>60Hz | Enclosure to earth                                   | Normal                              | --                 | 0.04mA <sub>pk</sub>                        | 60 | ES1      |
|   |                  |  | Abnormal (as table B.3)             | --                 | 0.04mA <sub>pk</sub>                        | 60 |          |
|   |                  |  | Single fault – SC/OC (as table B.4) | --                 | 0.04mA <sub>pk</sub>                        | 60 |          |

#### 5.2.2.3 - Capacitance Limits

| IEC 62368-1 |                    |                 |         |
|-------------|--------------------|-----------------|---------|
| Clause      | Requirement + Test | Result - Remark | Verdict |

| No. | Supply Voltage | Location (e.g. circuit designation) | Test conditions      | Parameters      |         | ES Class |
|-----|----------------|-------------------------------------|----------------------|-----------------|---------|----------|
|     |                |                                     |                      | Capacitance, nF | Upk (V) |          |
| --  | --             | --                                  | Normal               | C3=0.33µF       | 378     | ES3      |
|     |                |                                     | Abnormal             | --              | --      | --       |
|     |                |                                     | Single fault – SC/OC | --              | --      | --       |

## 5.2.2.4 - Single Pulses

| No. | Supply Voltage | Location (e.g. circuit designation) | Test conditions      | Parameters    |         |                      | ES Class |
|-----|----------------|-------------------------------------|----------------------|---------------|---------|----------------------|----------|
|     |                |                                     |                      | Duration (ms) | Upk (V) | l <sub>pk</sub> (mA) |          |
| --  | --             | --                                  | Normal               | --            | --      | --                   | --       |
|     |                |                                     | Abnormal             | --            | --      | --                   |          |
|     |                |                                     | Single fault – SC/OC | --            | --      | --                   |          |

## 5.2.2.5 - Repetitive Pulses

| No. | Supply Voltage | Location (e.g. circuit designation) | Test conditions      | Parameters    |         |                      | ES Class |
|-----|----------------|-------------------------------------|----------------------|---------------|---------|----------------------|----------|
|     |                |                                     |                      | Off time (ms) | Upk (V) | l <sub>pk</sub> (mA) |          |
| --  | --             | --                                  | Normal               | --            | --      | --                   | --       |
|     |                |                                     | Abnormal             | --            | --      | --                   |          |
|     |                |                                     | Single fault – SC/OC | --            | --      | --                   |          |

## Test Conditions:

Normal – Full load and no load.

Abnormal – Overload output

Supplementary information: SC=Short Circuit, OC=Open Circuit

| IEC 62368-1                                |  |                 |           |               |                                  |
|--|--|-----------------|-----------|---------------|----------------------------------|
| Clause                                     | Requirement + Test                     | Result - Remark |           |               | Verdict                          |
| <b>5.4.1.4,<br/>6.3.2, 9.0,<br/>B.2.6</b>  | <b>TABLE: Temperature measurements</b> |                 |           |               | P                                |
|  | Supply voltage (V) .....               | 90V/60Hz        | 264V/60Hz | ---           |                                  |
|  | Ambient T <sub>min</sub> (°C) .....    | --              | --        | ---           |                                  |
|  | Ambient T <sub>max</sub> (°C) .....    | --              | --        | ---           |                                  |
|  | T <sub>ma</sub> (°C) .....             | --              | --        | ---           |                                  |
| Maximum measured temperature T of part/at: |  | T (°C)          |           |               | Allowed<br>T <sub>max</sub> (°C) |
|  |  | Label<br>down   | Label up  | Label<br>down | Label up                         |
|  |  |                 |           |               | --                               |
| <b>Model: FWE050012B 100% rated load</b>   |  |                 |           |               |                                  |
| AC inlet pin                               | 52.8                                   | 49.8            | 48.0      | 45.8          | 70                               |
| L2   | 97.3                                   | 99.3            | 71.9      | 71.8          | 130                              |
| C3(X capacitor)                            | 69.5                                   | 66.2            | 61.9      | 59.3          | 110                              |
| C1   | 88.2                                   | 85.5            | 82.0      | 79.4          | 105                              |
| U3(photo-coupler)                          | 71.9                                   | 65.0            | 71.7      | 64.4          | 100                              |
| CY1  | 88.4                                   | 85.5            | 93.2      | 90.2          | 125                              |
| HS1  | 83.6                                   | 90.5            | 89.4      | 96.1          | --                               |
| PCB under BD1                              | 107.6                                  | 106.3           | 87.8      | 86.3          | 130                              |
| PCB under Q2                               | 110.4                                  | 110.1           | 110.1     | 109.8         | 130                              |
| PCB under T1                               | 81.3                                   | 76.1            | 83.5      | 77.4          | 130                              |
| T1 core                                    | 94.7                                   | 92.2            | 106.1     | 98.8          | 110                              |
| T1 coil                                    | 99.5                                   | 95.7            | 103.1     | 101.2         | 110                              |
| C5   | 73.3                                   | 72.7            | 73.0      | 71.9          | 105                              |
| L1   | 67.5                                   | 61.2            | 59.8      | 54.5          | 130                              |
| L3   | 73.4                                   | 72.4            | 74.1      | 72.2          | 130                              |
| output wire                                | 58.0                                   | 58.0            | 58.3      | 58.0          | 80                               |
| enclosure inside                           | 74.6                                   | 67.4            | 75.5      | 69.7          | 120                              |
| enclosure outside                          | 72.6                                   | 59.6            | 77.7      | 61.8          | --                               |
| ambient                                    | 39.3                                   | 38.8            | 39.4      | 39.4          | --                               |
| Enclosure surface at 25 °C                 |  |                 |           |               |                                  |

| IEC 62368-1                              |                    |       |                 |       |         |
|--|--------------------|-------|-----------------|-------|---------|
| Clause                                   | Requirement + Test |       | Result - Remark |       | Verdict |
| Top enclosure outside                    | 51.64              | 55.25 | 54.43           | 57.17 | 77      |
| Bottom enclosure outside                 | 41.67              | 36.20 | 42.36           | 35.72 | 77      |
| Output wire surface                      | 30.02              | 30.42 | 30.66           | 30.33 | 77      |
| Ambient                                  | 25.0               | 25.0  | 25.0            | 25.0  | --      |
| <b>Model: FWE050012B 50% rated load</b>  |                    |       |                 |       |         |
| AC inlet pin                             | 64.4               | 64.0  | 63.6            | 62.8  | 70      |
| L2                                       | 81.7               | 82.9  | 76.2            | 76.1  | 130     |
| C3(X capacitor)                          | 71.0               | 70.5  | 71.4            | 70.4  | 110     |
| C1                                       | 79.7               | 79.3  | 82.4            | 81.2  | 105     |
| U3(photo-coupler)                        | 72.7               | 70.0  | 76.0            | 72.1  | 100     |
| CY1                                      | 80.5               | 80.1  | 88.3            | 87.4  | 125     |
| HS1                                      | 78.1               | 78.9  | 88.5            | 86.2  | --      |
| PCB under BD1                            | 88.4               | 88.5  | 86.1            | 85.7  | 130     |
| PCB under Q2                             | 91.7               | 91.9  | 100.2           | 100.2 | 130     |
| PCB under T1                             | 77.0               | 75.1  | 82.0            | 79.2  | 130     |
| T1 core                                  | 84.0               | 83.1  | 94.3            | 92.5  | 110     |
| T1 coil                                  | 85.5               | 84.2  | 94.5            | 92.5  | 110     |
| C5                                       | 72.4               | 72.7  | 75.6            | 75.9  | 105     |
| L1                                       | 69.8               | 68.3  | 69.5            | 67.6  | 130     |
| L3                                       | 71.5               | 72.0  | 74.5            | 74.7  | 130     |
| output wire                              | 66.1               | 66.7  | 68.0            | 68.4  | 80      |
| enclosure inside                         | 74.2               | 71.5  | 79.1            | 75.3  | 120     |
| enclosure outside                        | 72.9               | 67.8  | 77.9            | 70.6  | 95      |
| ambient                                  | 58.8               | 59.3  | 59.1            | 59.5  | --      |
| <b>Model: FWE050024B 100% rated load</b> |                    |       |                 |       |         |
| AC inlet pin                             | 51.9               | 49.2  | 46.7            | 44.9  | 70      |
| L2                                       | 98.5               | 101.5 | 71.5            | 71.1  | 130     |
| C3(X capacitor)                          | 69.5               | 66.0  | 60.9            | 59.7  | 110     |
| C1                                       | 87.9               | 84.1  | 78.6            | 76.1  | 105     |
| U3(photo-coupler)                        | 90.0               | 85.8  | 82.7            | 79.8  | 100     |
| CY1                                      | 81.4               | 73.6  | 81.4            | 75.1  | 125     |
| HS1                                      | 91.2               | 90.7  | 94.2            | 96.4  | --      |
| PCB under BD1                            | 111.4              | 109.2 | 87.9            | 86.0  | 130     |



| IEC 62368-1                             |                    |       |                 |       |         |
|---|--------------------|-------|-----------------|-------|---------|
| Clause                                  | Requirement + Test |       | Result - Remark |       | Verdict |
| PCB under Q2                            | 102.7              | 102.1 | 102.6           | 103.9 | 130     |
| PCB under T1                            | 85.2               | 79.5  | 85.4            | 81.2  | 130     |
| T1 core                                 | 94.7               | 91.9  | 95.1            | 95.4  | 110     |
| T1 coil                                 | 96.9               | 99.2  | 97.0            | 102.1 | 110     |
| C5                                      | 72.7               | 69.5  | 71.9            | 69.7  | 105     |
| L1                                      | 67.3               | 60.3  | 58.2            | 53.5  | 130     |
| L3                                      | 71.7               | 67.8  | 71.1            | 68.2  | 130     |
| output wire                             | 63.4               | 60.5  | 63.0            | 60.9  | 80      |
| enclosure inside                        | 76.4               | 66.1  | 76.4            | 67.2  | 120     |
| enclosure outside                       | 73.5               | 65.3  | 72.0            | 65.0  | 95      |
| ambient                                 | 39.0               | 38.8  | 38.9            | 38.7  | --      |
| Enclosure surface at 25 °C              |                    |       |                 |       |         |
| Top enclosure outside                   | 50.82              | 62.08 | 53.37           | 61.50 | 77      |
| Bottom enclosure outside                | 41.18              | 35.86 | 41.79           | 35.27 | 77      |
| Output wire surface                     | 28.47              | 29.52 | 29.32           | 29.19 | 77      |
| Ambient                                 | 25.0               | 25.0  | 25.0            | 25.0  | --      |
| <b>Model: FWE050024B 50% rated load</b> |                    |       |                 |       |         |
| AC inlet pin                            | 64.4               | 64.4  | 64.6            | 63.4  | 70      |
| L2                                      | 83.3               | 84.4  | 78.5            | 77.8  | 130     |
| C3 (X capacitor)                        | 71.5               | 71.1  | 80.3            | 71.5  | 110     |
| C1                                      | 79.7               | 80.1  | 83.6            | 82.0  | 105     |
| U3 (photo-coupler)                      | 80.8               | 81.3  | 85.7            | 85.4  | 100     |
| CY1                                     | 77.6               | 76.5  | 85.2            | 82.0  | 125     |
| HS1                                     | 83.1               | 84.0  | 97.0            | 98.3  | --      |
| PCB under BD1                           | 90.7               | 91.1  | 89.5            | 87.8  | 130     |
| PCB under Q2                            | 89.1               | 89.4  | 101.3           | 100.4 | 130     |
| PCB under T1                            | 79.5               | 79.7  | 86.1            | 85.1  | 130     |
| T1 core                                 | 83.4               | 83.3  | 93.2            | 91.8  | 110     |
| T1 coil                                 | 84.9               | 83.6  | 96.2            | 93.3  | 110     |
| C5                                      | 72.8               | 73.0  | 77.8            | 77.3  | 105     |
| L1                                      | 69.8               | 69.0  | 73.2            | 68.3  | 130     |
| L3                                      | 72.2               | 72.4  | 77.1            | 76.3  | 130     |
| output wire                             | 68.7               | 69.6  | 72.5            | 72.6  | 80      |

| IEC 62368-1 |                    |                 |         |
|-------------|--------------------|-----------------|---------|
| Clause      | Requirement + Test | Result - Remark | Verdict |

|                   |      |      |      |      |     |
|-------------------|------|------|------|------|-----|
| enclosure inside  | 73.5 | 71.5 | 79.6 | 75.8 | 120 |
| enclosure outside | 72.7 | 71.0 | 77.8 | 74.8 | --  |
| ambient           | 58.9 | 57.6 | 59.4 | 59.1 | --  |

Supplementary information:

\* Temperature limit for TS1 of accessible enclosure according to Table 38.

Note 1:

With a rated maximum ambient temperature of 40°C for 100% load, 60°C for 50% load, the maximum temperature are calculated as follows:

Winding components providing safety isolation:

- Class B →  $T_{max} = 120^{\circ}\text{C} - 10^{\circ}\text{C} = 110^{\circ}\text{C}$  (10°C decreased by thermocouple method)

Output cord with maximum temperature rise of:

- 125°C (for the output wire wrapped with 125°C heat-shrinkable tube)

| Temperature T of winding: | t <sub>1</sub> (°C) | R <sub>1</sub> (Ω) | t <sub>2</sub> (°C) | R <sub>2</sub> (Ω) | T (°C) | Allowed T <sub>max</sub> (°C) | Insulation class |
|---------------------------|---------------------|--------------------|---------------------|--------------------|--------|-------------------------------|------------------|
| --                        | --                  | --                 | --                  | --                 | --     | --                            | --               |

| 5.4.1.10.2                    | TABLE: Vicat softening temperature of thermoplastics | N/A              |
|-------------------------------|--|------------------|
| Penetration (mm).....         |  | —                |
| Object/ Part No./Material     | Manufacturer/trademark                               | T softening (°C) |
| --                            | --   | --               |
| supplementary information: -- |  |                  |

| 5.4.1.10.3   | TABLE: Ball pressure test of thermoplastics | N/A                   |                          |
|--|---|-----------------------|--------------------------|
| Allowed impression diameter (mm) .....   | ≤ 2mm                                       | —                     |                          |
| Object/Part No./Material   | Manufacturer/trademark                      | Test temperature (°C) | Impression diameter (mm) |
| --   | --  | --                    | --                       |
| Supplementary information: The bobbin material of transformer (T1) is phenolic, no test is needed. |   |                       |                          |

| 5.4.2.2, 5.4.2.4 and 5.4.3                               | TABLE: Minimum Clearances/Creepage distance | P            |                              |                  |                      |                               |         |
|--|---|--------------|------------------------------|------------------|----------------------|-------------------------------|---------|
| Clearance (cl) and creepage distance (cr) at/of/between: | Up (V)                                      | U r.m.s. (V) | Frequency (kHz) <sup>1</sup> | Required cl (mm) | cl (mm) <sup>2</sup> | Required cr (mm) <sup>3</sup> | cr (mm) |
| (B1)   |   |              |                              |                  |                      |                               |         |
| L, N trace before fuse                                   | 420   | 250          | 0.06                         | 2.3              | 3.5                  | 2.5                           | 3.5     |
| PCB trace between two pins of F1                         | 420   | 250          | 0.06                         | 2.3              | 3.2                  | 2.5                           | 3.2     |

| IEC 62368-1 |                    |                 |         |
|-------------|--------------------|-----------------|---------|
| Clause      | Requirement + Test | Result - Remark | Verdict |

| Reinforced:   |     |     |      |     |      |     |      |
|---|-----|-----|------|-----|------|-----|------|
| Primary circuit to enclosure (around)   | 420 | 250 | 0.06 | 4.5 | 7.0  | 5.0 | 5.9  |
| Primary circuit to secondary heat-sink  | 420 | 250 | 0.06 | 4.5 | 8.0  | 5.0 | 10.0 |
| Primary circuit to secondary circuit (PCB under T1)   | 600 | 313 | 84.7 | 4.5 | 10.0 | 6.4 | 10.0 |
| Primary winding to secondary winding (T1)   | 600 | 313 | 0.06 | 4.5 | 10.0 | 6.4 | 10.0 |
| Core to secondary winding (T1)  | 600 | 313 | 84.7 | 4.5 | 10.0 | 6.4 | 10.0 |
| Core to secondary component (E-cap.)  | 600 | 313 | 84.7 | 4.5 | 10.0 | 6.4 | 10.0 |
| Primary circuit to secondary circuit (PCB under U2)   | 420 | 250 | 0.06 | 4.5 | 8.3  | 5.0 | 8.3  |
| Primary circuit to secondary circuit (PCB under CY1)  | 420 | 250 | 0.06 | 4.5 | 8.7  | 5.0 | 8.7  |
| Supplementary information:  |     |     |      |     |      |     |      |
| 1) Functional insulation shorted tests, refer to sub-clause 5.3.4 c).<br>2) All internal wire are fixed with two independently method.<br>3) For transformer T1: Core of transformer T1 is considered as primary circuit.<br>4) Unless otherwise specified, the worst conditions of Cl. & Cr. in above mentioned locations have been considered and listed.<br>5) The equipment to be operated up to 5000 m above sea level, each clearance multiplied with an altitude correction factor of 1.48.<br>FI: Functional insulation; BI: Basic insulation; SI: Supplementary insulation; RI: Reinforced insulation. |     |     |      |     |      |     |      |

| 5.4.2.3  | TABLE: Minimum Clearances distances using required withstand voltage |                                      |                                      | P  |
|--|--|--------------------------------------|--------------------------------------|----|
|  | Overvoltage Category (OV):   |                                      |                                      | II |
|  | Pollution Degree:  |                                      |                                      | 2  |
| Clearance distanced between:   | Required withstand voltage   | Required cl (mm)                     | Measured cl (mm)                     |    |
| Line to Neutral (fuse disconnected)  | 2500V  | See table 5.4.2.2, 5.4.2.4 and 5.4.3 | See table 5.4.2.2, 5.4.2.4 and 5.4.3 |    |
| Primary to secondary circuits (except for transformer)   | 4000V  | See table 5.4.2.2, 5.4.2.4 and 5.4.3 | See table 5.4.2.2, 5.4.2.4 and 5.4.3 |    |
| Primary to secondary circuits (for transformer)  | 4000V  | See table 5.4.2.2, 5.4.2.4 and 5.4.3 | See table 5.4.2.2, 5.4.2.4 and 5.4.3 |    |
| Supplementary information:   |  |                                      |                                      |    |
| 1) Limits in previous table for clearance selected based on Table 15 for Required Withstand Voltage 2.5kV (mains transient voltage 2.5kV).<br>2) All measurements for clearance refer to above table 5.4.2.2, 5.4.2.4 and 5.4.3. |  |                                      |                                      |    |

| IEC 62368-1 |                    |                 |         |
|-------------|--------------------|-----------------|---------|
| Clause      | Requirement + Test | Result - Remark | Verdict |

| 5.4.2.4  | TABLE: Clearances based on electric strength test |                                       |                    | N/A |
|--|---|---------------------------------------|--------------------|-----|
| Test voltage applied between:  | Required cl (mm)                                  | Test voltage (kV) peak/ r.m.s. / d.c. | Breakdown Yes / No |     |
| --   | --  | --                                    | --                 |     |
| Supplementary information: Using procedure 2 to determine the clearance. |   |                                       |                    |     |

| 5.4.4.2, 5.4.4.5 c) 5.4.4.9                            | TABLE: Distance through insulation measurements |                |                          |                   |          | P |
|--|---|----------------|--------------------------|-------------------|----------|---|
| Distance through insulation di at/of:                  | Peak voltage (V)                                | Frequency (Hz) | Material                 | Required DTI (mm) | DTI (mm) |   |
| Enclosure  | 600   | 84.7           | See appended table 4.1.2 | 0.4               | 1)       |   |
| Opto-coupler   | 420   | 0.06           | See appended table 4.1.2 | 0.4               | 1)       |   |
| Supplementary information: 1) See appended table 4.1.2 |   |                |                          |                   |          |   |

| 5.4.9  | TABLE: Electric strength tests |                      |                    | P |
|--|--------------------------------|----------------------|--------------------|---|
| Test voltage applied between:  | Voltage shape (AC, DC)         | Test voltage (Vpeak) | Breakdown Yes / No |   |
| Basic/supplementary:   |                                |                      |                    |   |
| Different polarity of power supply (Fuse disconnection)                          | DC                             | 2500                 | No                 |   |
| Reinforced   |                                |                      |                    |   |
| Unit: Primary circuit to secondary circuit                                       | DC                             | 4242                 | No                 |   |
| Unit: Primary circuit to enclosure   | DC                             | 4242                 | No                 |   |
| Transformer: Primary winding to secondary winding                                | DC                             | 4242                 | No                 |   |
| Transformer: Core to secondary winding   | DC                             | 4242                 | No                 |   |
| One layer insulation type  | DC                             | 4242                 | No                 |   |
| Supplementary information: Core of transformer T1 was considered as primary part |                                |                      |                    |   |

| 5.5.2.2                | TABLE: Stored discharge on capacitors |                            |                           |                                    |                   | P |
|------------------------|---------------------------------------|----------------------------|---------------------------|------------------------------------|-------------------|---|
| Supply Voltage (V), Hz | Test Location                         | Operating Condition (N, S) | Switch position On or off | Measured Voltage (after 2 seconds) | ES Classification |   |
| 264V, 60Hz             | L-N                                   | N                          | --                        | 0                                  | ES1               |   |

| IEC 62368-1 |                    |                 |         |
|-------------|--------------------|-----------------|---------|
| Clause      | Requirement + Test | Result - Remark | Verdict |

Supplementary information:

X-capacitors installed for testing are: C3=0.33µF

Approval bleeding resistor rating: see table 4.1.2  ICX: TEA18362

Notes:

A. Test Location: Phase to Neutral

B. Operating condition abbreviations: N – Normal operating condition (e.g., normal operation, or open fuse);

S –Single fault condition (Bleeder Resistor open circuit)

| 5.6.6.2         | TABLE: Resistance of protective conductors and terminations |                |                  |                | N/A |
|-----------------|---|----------------|------------------|----------------|-----|
| Accessible part | Test current (A)  | Duration (min) | Voltage drop (V) | Resistance (Ω) |     |
| --              | --  | --             | --               | --             |     |
| --              | --  | --             | --               | --             |     |

Supplementary Information: --

| 5.7.2.2, 5.7.4       | TABLE: Earthed accessible conductive part   |  | N/A                |
|----------------------|---|--|--------------------|
| Supply voltage ..... | 264Vac  |  | —                  |
| Location             | Test conditions specified in 6.1 of IEC 60990 or Fault Condition No in IEC 60990 clause 6.2.2.1 through 6.2.2.8, except for 6.2.2.7 |  | Touch current (mA) |
| Output terminal      | 1   |  | N/A                |
| --                   | 2*  |  | N/A                |
| --                   | 3   |  | N/A                |
| --                   | 4   |  | N/A                |
| --                   | 5   |  | N/A                |
| --                   | 6   |  | N/A                |
| --                   | 8   |  | N/A                |

Notes:

[1] Supply voltage is the anticipated maximum Touch Voltage

[2] Earthed neutral conductor [Voltage differences less than 1% or more]

[3] Specify method used for measurement as described in IEC 60990 sub-clause 4.3

[4] IEC60990, sub-clause 6.2.2.7, Fault 7 not applicable.

[5] (\*) IEC60990, sub-clause 6.2.2.2 is not applicable if switch or disconnect device (e.g., appliance coupler) provided.

| IEC 62368-1 |                    |                 |         |
|-------------|--------------------|-----------------|---------|
| Clause      | Requirement + Test | Result - Remark | Verdict |

| 6.2.2  | Table: Electrical power sources (PS) measurements for classification |             |                     |                                    | P                 |
|--|--|-------------|---------------------|------------------------------------|-------------------|
| Source   | Description  | Measurement | Max Power after 3 s | Max Power after 5 s <sup>*</sup> ) | PS Classification |
| Output   | Normal operation (FWE050012B)  | Power (W) : | --                  | 62.4                               | PS2               |
|  |  | VA (V) :    | --                  | 12.22                              |                   |
|  |  | IA (A) :    | --                  | 5.35                               |                   |
| Output   | Abnormal operation (FWE050012B)                                      | Power (W) : | --                  | 62.4                               | PS2               |
|  |  | VA (V) :    | --                  | 12.22                              |                   |
|  |  | IA (A) :    | --                  | 5.35                               |                   |
| Output   | Single fault conditions (Q1 pin D to S SC) (FWE050012B)              | Power (W) : | 0                   | --                                 | PS1               |
|  |  | VA (V) :    | 0                   | --                                 |                   |
|  |  | IA (A) :    | 0                   | --                                 |                   |
| Output   | Normal operation (FWE050024B)  | Power (W) : | --                  | 64.8                               | PS2               |
|  |  | VA (V) :    | --                  | 24.43                              |                   |
|  |  | IA (A) :    | --                  | 2.80                               |                   |
| Output   | Abnormal operation (FWE050024B)                                      | Power (W) : | --                  | 64.8                               | PS2               |
|  |  | VA (V) :    | --                  | 24.43                              |                   |
|  |  | IA (A) :    | --                  | 2.80                               |                   |
| Output   | Single fault conditions (Q1 pin D to S SC) (FWE050024B)              | Power (W) : | 0                   | --                                 | PS1               |
|  |  | VA (V) :    | 0                   | --                                 |                   |
|  |  | IA (A) :    | 0                   | --                                 |                   |
| Supplementary information:<br>Declared All internal circuit is PS3 |  |             |                     |                                    |                   |

| 6.2.3.1   | Table: Determination of Potential Ignition Sources (Arcing PIS) |  |   |                      | P |
|---|---|--|---|----------------------|---|
| Location  | Open circuit voltage After 3 s (V <sub>p</sub> )                | Measured r.m.s current (I <sub>rms</sub> ) | Calculated value (V <sub>p</sub> x I <sub>rms</sub> ) | Arcing PIS? Yes / No |   |
| See below   | --  | --   | --  | --                   |   |
| Supplementary information:<br><b>Considered arcing PIS in all primary and secondary circuit.</b><br>An Arcing PIS requires a minimum of 50 V (peak) a.c. or d.c. An Arcing PIS is established when the product of the open circuit voltage (V <sub>p</sub> ) and normal operating condition rms current (I <sub>rms</sub> ) is greater than 15. |   |  |   |                      |   |

| 6.2.3.2 | Table: Determination of Potential Ignition Sources (Resistive PIS) |  |  |  | P |
|---------|--|--|--|--|---|
|---------|--|--|--|--|---|

| IEC 62368-1 |                    |                 |         |
|-------------|--------------------|-----------------|---------|
| Clause      | Requirement + Test | Result - Remark | Verdict |

| Circuit Location (x-y) | Operating Condition<br>(Normal / Describe<br>Single Fault) | Measured<br>wattage or<br>VA<br>During first<br>30 s (W / VA) | Measured<br>wattage or<br>VA<br>After 30 s (W<br>/ VA) | Protective Circuit,<br>Regulator, or<br>PTC Operated?<br>Yes / No<br>(Comment) | Resistive<br>PIS?<br>Yes/No |
|------------------------|--|---|--|--|-----------------------------|
| --                     | --   | --  | --   | --   | --                          |

Supplementary Information:

**Considered resistive PIS in all primary and secondary circuit.**

A combination of voltmeter, VA and ammeter IA may be used instead of a wattmeter.

A Resistive PIS: (a) dissipates more than 15 W, measured after 30 s of normal operation, or (b) under single fault conditions has either a power exceeding 100 W measured immediately after the introduction of the fault if electronic circuits, regulators or PTC devices are used, or has an available power exceeding 15 W measured 30 s after introduction of the fault.

| 8.5.5   | TABLE: High Pressure Lamp | N/A                          |
|---|---------------------------|------------------------------|
| Description                                     | Values                    | Energy Source Classification |
| Lamp type.....:                                 |                           | —                            |
| Manufacturer .....                              |                           | —                            |
| Cat no. ....:                                   |                           | —                            |
| Pressure (cold) (MPa).....:                     |                           | MS_                          |
| Pressure (operating) (MPa) .....                |                           | MS_                          |
| Operating time (minutes) .....                  |                           | —                            |
| Explosion method.....:                          |                           | —                            |
| Max particle length escaping enclosure (mm) ..: |                           | MS_                          |
| Max particle length beyond 1 m (mm).....:       |                           | MS_                          |
| Overall result .....                            |                           |                              |
| Supplementary information:                      |                           |                              |

| B.2.5                    | TABLE: Input test |             |       |             |         |            |                  | P |
|--------------------------|-------------------|-------------|-------|-------------|---------|------------|------------------|---|
| U (V)                    | I (A)             | I rated (A) | P (W) | P rated (W) | Fuse No | I fuse (A) | Condition/status |   |
| Model: <b>FWE050012B</b> |                   |             |       |             |         |            |                  |   |

| IEC 62368-1 |                    |  |  |  |                 |  |         |
|-------------|--------------------|--|--|--|-----------------|--|---------|
| Clause      | Requirement + Test |  |  |  | Result - Remark |  | Verdict |

|     |      |     |       |    |    |      |                     |
|-----|------|-----|-------|----|----|------|---------------------|
| 90  | 1.07 | --  | 57.40 | -- | F1 | 1.07 | Rated load at 50 Hz |
| 90  | 1.09 | --  | 57.44 | -- | F1 | 1.09 | Rated load at 60 Hz |
| 100 | 0.98 | 1.5 | 56.84 | -- | F1 | 0.98 | Rated load at 50 Hz |
| 100 | 1.00 | 1.5 | 56.88 | -- | F1 | 1.00 | Rated load at 60 Hz |
| 240 | 0.59 | 1.5 | 57.83 | -- | F1 | 0.59 | Rated load at 50 Hz |
| 240 | 0.57 | 1.5 | 57.03 | -- | F1 | 0.57 | Rated load at 60 Hz |
| 264 | 0.55 | --  | 58.21 | -- | F1 | 0.55 | Rated load at 50 Hz |
| 264 | 0.53 | --  | 57.28 | -- | F1 | 0.53 | Rated load at 60 Hz |

**Model: FWE050024B**

|     |      |     |       |    |    |      |                     |
|-----|------|-----|-------|----|----|------|---------------------|
| 90  | 1.07 | --  | 56.57 | -- | F1 | 1.07 | Rated load at 50 Hz |
| 90  | 1.09 | --  | 56.15 | -- | F1 | 1.09 | Rated load at 60 Hz |
| 100 | 0.98 | 1.5 | 56.23 | -- | F1 | 0.98 | Rated load at 50 Hz |
| 100 | 1.00 | 1.5 | 55.93 | -- | F1 | 1.00 | Rated load at 60 Hz |
| 240 | 0.59 | 1.5 | 57.20 | -- | F1 | 0.59 | Rated load at 50 Hz |
| 240 | 0.57 | 1.5 | 55.75 | -- | F1 | 0.57 | Rated load at 60 Hz |
| 264 | 0.55 | --  | 57.63 | -- | F1 | 0.55 | Rated load at 50 Hz |
| 264 | 0.53 | --  | 56.03 | -- | F1 | 0.53 | Rated load at 60 Hz |

Supplementary information:

The maximum measured current under rated voltage did not exceed 110% of the rated current

| <b>B.3</b>   |                    | <b>TABLE: Abnormal operating condition tests</b> |                |          |   |          |                                    | <b>P</b>               |  |
|--|--------------------|--|----------------|----------|---|----------|------------------------------------|------------------------|--|
| Ambient temperature (°C) .....                                   |                    |  |                |          | 25°C, if not specified                            |          |                                    | —                      |  |
| Power source for EUT: Manufacturer, model/type, output rating .. |                    |  |                |          | --  |          |                                    | —                      |  |
| Component No.  | Abnormal Condition | Supply voltage, (V)                              | Test time (ms) | Fuse no. | Fuse current, (A)                                 | T-couple | Temp. (°C)                         | Observation            |  |
| <b>Model: FWE050024B</b>   |                    |  |                |          |   |          |                                    |                        |  |
| Output   | SC                 | 264  | 120min.        | F1       | 0.03  | Type K   | Coil: 42.07°C<br>Ambient: 38.75°C  | No hazardous observed. |  |
| Output   | OL                 | 264  | 664min.        | F1       | 0.54→<br>0.58→<br>0.61→<br>0.63→<br>0.65→<br>0.03 | Type K   | Coil: 111.89°C<br>Ambient: 38.73°C | No hazardous observed. |  |



| IEC 62368-1              |                    |     |         |    |   |                 |   |                        |
|--------------------------|--------------------|-----|---------|----|---|-----------------|---|------------------------|
| Clause                   | Requirement + Test |     |         |    |   | Result - Remark | Verdict   |                        |
| Output                   | OL                 | 264 | 564min. | F1 | 0.34→<br>0.45→<br>0.51→<br>0.57→<br>0.61→<br>0.03 | Type K          | Coil: 117.64°C<br>Ambient:<br>58.90°C   | No hazardous observed. |
| Transformer              | OL                 | 264 | 659min. | F1 | 0.54→<br>0.58→<br>0.61→<br>0.63→<br>0.65→<br>0.03 | Type K          | Coil: 105.86°C<br>Ambient:<br>38.94°C   | No hazardous observed. |
| Transformer              | OL                 | 264 | 540min. | F1 | 0.34→<br>0.45→<br>0.51→<br>0.57→<br>0.61→<br>0.03 | Type K          | Coil: 118.04°C<br>Ambient:<br>59.53°C   | No hazardous observed. |
| Output                   | SC                 | 264 | 120min. | F1 | 0.03  | Type K          | Top enclosure outside:<br>24.72°C<br>Bottom enclosure outside:<br>24.62°C<br>Output wire surface:<br>23.96°C<br>Ambient:<br>23.69°C   | No hazardous observed. |
| Output                   | OL                 | 264 | 664min. | F1 | 0.54→<br>0.58→<br>0.61→<br>0.63→<br>0.65→<br>0.03 | Type K          | Top enclosure outside :<br>69.17°C<br>Bottom enclosure outside:<br>37.78 °C<br>Output wire surface:<br>30.67°C<br>Ambient:<br>24.87°C | No hazardous observed. |
| <b>Model: FWE050012B</b> |                    |     |         |    |   |                 |   |                        |
| Output                   | SC                 | 264 | 125min. | F1 | 0.03  | Type K          | Coil: 43.09°C<br>Ambient:<br>39.81°C  | No hazardous observed. |

| IEC 62368-1 |                    |     |         |    |   |                 |  |                        |
|-------------|--------------------|-----|---------|----|---|-----------------|--|------------------------|
| Clause      | Requirement + Test |     |         |    |   | Result - Remark | Verdict  |                        |
| Output      | OL                 | 264 | 653min. | F1 | 0.58→<br>0.61→<br>0.64→<br>0.66→<br>0.67→<br>0.03 | Type K          | Coil: 110.93°C<br>Ambient:<br>39.39°C  | No hazardous observed. |
| Output      | OL                 | 264 | 530min. | F1 | 0.34→<br>0.38→<br>0.43→<br>0.47→<br>0.52→<br>0.03 | Type K          | Coil: 115.17°C<br>Ambient:<br>58.40°C  | No hazardous observed. |
| Transformer | OL                 | 264 | 683min. | F1 | 0.58→<br>0.61→<br>0.64→<br>0.66→<br>0.67→<br>0.03 | Type K          | Coil: 115.87°C<br>Ambient:<br>39.36°C  | No hazardous observed. |
| Transformer | OL                 | 264 | 564min. | F1 | 0.34→<br>0.38→<br>0.43→<br>0.47→<br>0.52→<br>0.03 | Type K          | Coil: 115.01°C<br>Ambient:<br>59.19°C  | No hazardous observed. |
| Output      | SC                 | 264 | 125min. | F1 | 0.03  | Type K          | Top enclosure<br>outside :<br>25.50°C<br>Bottom<br>enclosure<br>outside:<br>24.81°C<br>Output wire<br>surface:<br>24.35°C<br>Ambient:<br>23.69°C | No hazardous observed. |

| IEC 62368-1 |                    |  |                 |         |
|-------------|--------------------|--|-----------------|---------|
| Clause      | Requirement + Test |  | Result - Remark | Verdict |

|        |    |     |         |    |   |        |  |                           |
|--------|----|-----|---------|----|---|--------|--|---------------------------|
| Output | OL | 264 | 653min. | F1 | 0.58→<br>0.61→<br>0.64→<br>0.66→<br>0.67→<br>0.03 | Type K | Top enclosure<br>outside :<br>62.58°C<br>Bottom<br>enclosure<br>outside:<br>34.49°C<br>Output wire<br>surface:<br>31.99°C<br>Ambient:<br>24.87°C | No hazardous<br>observed. |
|--------|----|-----|---------|----|---|--------|--|---------------------------|

Supplementary information:

Test table is provided to record abnormal and fault conditions for all applicable energy sources including Thermal burn injury. Column "Abnormal/Fault." Specify if test condition by indicating "Abnormal" then the condition for a Clause B.3 test or "Single Fault" then the condition for Clause B.4.

1) S-C: Short-circuited; O-C: Open-circuited; O-L: Overloaded.

2) The test result shown all safeguards remained effective and didn't lead to a single fault condition during abnormal operating condition; In addition all safeguards complied with applicable requirements in this standard after restoration of normal operating conditions.

3) The test result showed no Class 1 or 2 energy source become Class 3 level during and after single fault condition.

4) The overloaded condition is applied according to annex G.5.3.3.

Winding Limit for T1: 175-10=165°C.

| B.4  |                 | TABLE: Fault condition tests |                |          |                        |          |            |  | P |
|--|-----------------|------------------------------|----------------|----------|------------------------|----------|------------|--|---|
| Ambient temperature (°C) .....                                   |                 |                              |                |          | 25°C, if not specified |          |            | —                                      |   |
| Power source for EUT: Manufacturer, model/type, output rating .. |                 |                              |                |          | --                     |          |            | —                                      |   |
| Component No.  | Fault Condition | Supply voltage, (V)          | Test time (ms) | Fuse no. | Fuse current, (A)      | T-couple | Temp. (°C) | Observation                            |   |
| <b>Model: FWE050024B</b>   |                 |                              |                |          |                        |          |            |  |   |
| Q1 pin D-S   | SC              | 264                          | 5 min.         | F1       | --                     | --       | --         | Unit shut down immediately, F1 opened. |   |
| R21  | SC              | 264                          | 1sec           | F1       | --                     | --       | --         | Unit shut down immediately, F1 opened. |   |
| BD1+ to -  | SC              | 264                          | 1sec           | F1       | --                     | --       | --         | Unit shut down immediately, F1 opened. |   |

| IEC 62368-1 |                    |     |        |    |                 |    |    |   |
|-------------|--------------------|-----|--------|----|-----------------|----|----|---|
| Clause      | Requirement + Test |     |        |    | Result - Remark |    |    | Verdict   |
| D4          | SC                 | 264 | 5 min. | F1 | 0.03            | -- | -- | Unit shut down immediately, recovered after removing shorted circuit. |
| U2 pin4-8   | SC                 | 264 | 5min.  | F1 | 0.03            | -- | -- | Unit shut down immediately, recovered after removing shorted circuit. |
| U4 pinA-K   | SC                 | 264 | 5min.  | F1 | 0.03            | -- | -- | Unit shut down immediately, recovered after removing shorted circuit. |
| Q2 pinG-D   | SC                 | 264 | 1sec   | F1 | --              | -- | -- | Unit shut down immediately, F1 opened.                                |
| Q2 pinG-S   | SC                 | 264 | 5 min. | F1 | 0.03            | -- | -- | Unit shut down immediately, recovered after removing shorted circuit. |
| Q2 pinS-D   | SC                 | 264 | 1sec   | F1 | --              | -- | -- | Unit shut down immediately, F1 opened.                                |
| U3 pin1-2   | SC                 | 264 | 5 min. | F1 | 0.03            | -- | -- | Unit shut down immediately, recovered after removing shorted circuit. |
| U3 pin3-4   | SC                 | 264 | 5 min. | F1 | 0.03            | -- | -- | Unit shut down immediately, recovered after removing shorted circuit. |
| U3 pin1     | OC                 | 264 | 5 min. | F1 | 0.03            | -- | -- | Unit shut down immediately, recovered after removing shorted circuit. |

| IEC 62368-1 |                    |  |                 |         |
|-------------|--------------------|--|-----------------|---------|
| Clause      | Requirement + Test |  | Result - Remark | Verdict |

|         |    |     |        |    |      |    |    |   |
|---------|----|-----|--------|----|------|----|----|---|
| U3 pin3 | OC | 264 | 5 min. | F1 | 0.03 | -- | -- | Unit shut down immediately, recovered after removing shorted circuit. |
|---------|----|-----|--------|----|------|----|----|---|

**Supplementary information:**

Test table is provided to record abnormal and fault conditions for all applicable energy sources including Thermal burn injury. Column "Abnormal/Fault." Specify if test condition by indicating "Abnormal" then the condition for a Clause B.3 test or "Single Fault" then the condition for Clause B.4.

1) S-C: Short-circuited; O-C: Open-circuited; O-L: Overloaded.

2) The test result shown all safeguards remained effective and didn't lead to a single fault condition during abnormal operating condition; In addition all safeguards complied with applicable requirements in this standard after restoration of normal operating conditions.

3) The test result showed no Class 1 or 2 energy source become Class 3 level during and after single fault condition.

| Annex M   | TABLE: Batteries           |               |                         |                        |               |               |               |                   | N/A           |
|---|----------------------------|---------------|-------------------------|------------------------|---------------|---------------|---------------|-------------------|---------------|
| The tests of Annex M are applicable only when appropriate battery data is not available |                            |               |                         |                        |               |               |               |                   | N/A           |
| Is it possible to install the battery in a reverse polarity position? .....             |                            |               |                         |                        |               |               |               |                   | N/A           |
|   | Non-rechargeable batteries |               |                         | Rechargeable batteries |               |               |               |                   |               |
|   | Discharging                |               | Un-intentional charging | Charging               |               | Discharging   |               | Reversed charging |               |
|   | Meas. current              | Manuf. Specs. |                         | Meas. current          | Manuf. Specs. | Meas. current | Manuf. Specs. | Meas. current     | Manuf. Specs. |
| Max. current during normal condition  | --                         | --            | --                      | --                     | --            | --            | --            | --                | --            |
| Max. current during fault condition   | --                         | --            | --                      | --                     | --            | --            | --            | --                | --            |
| Test results:   |                            |               |                         |                        |               |               |               |                   | Verdict       |
| - Chemical leaks  |                            |               |                         |                        |               |               |               |                   | --            |
| - Explosion of the battery  |                            |               |                         |                        |               |               |               |                   | --            |
| - Emission of flame or expulsion of molten metal  |                            |               |                         |                        |               |               |               |                   | --            |
| - Electric strength tests of equipment after completion of tests                        |                            |               |                         |                        |               |               |               |                   | --            |
| Supplementary information: --   |                            |               |                         |                        |               |               |               |                   |               |

| Annex M.4        | Table: Additional safeguards for equipment containing secondary lithium batteries |              |       |          |             | N/A |
|------------------|---|--------------|-------|----------|-------------|-----|
| Battery/Cell No. | Test conditions   | Measurements |       |          | Observation |     |
|                  |   | U            | I (A) | Temp (C) |             |     |
| --               | Normal  | --           | --    | --       | --          |     |

| IEC 62368-1 |                    |                 |         |
|-------------|--------------------|-----------------|---------|
| Clause      | Requirement + Test | Result - Remark | Verdict |

|    |                     |    |    |    |    |
|----|---------------------|----|----|----|----|
| -- | Abnormal            | -- | -- | -- | -- |
| -- | Single fault –SC/OC | -- | -- | -- | -- |

Supplementary Information:

| Battery identification | Charging at $T_{\text{lowest}}$ (°C) | Observation | Charging at $T_{\text{highest}}$ (°C) | Observation |
|------------------------|--------------------------------------|-------------|---------------------------------------|-------------|
| --                     | --                                   | --          | --                                    | --          |

Supplementary Information:--

| Annex Q.1 | TABLE: Circuits intended for interconnection with building wiring (LPS) | P |
|-----------|---|---|
|-----------|---|---|

Note: Measured UOC (V) with all load circuits disconnected:

| Output Circuit | Components | U <sub>oc</sub> (V) | I <sub>sc</sub> (A) |       | S (VA) |       |
|----------------|------------|---------------------|---------------------|-------|--------|-------|
|                |            |                     | Meas.               | Limit | Meas.  | Limit |

**Model: FWE050012B**

|        |                  |       |      |     |      |     |
|--------|------------------|-------|------|-----|------|-----|
| Output | Normal condition | 12.28 | 5.32 | 8.0 | 61.7 | 100 |
| Output | U3 pin 1-2 S-C   | --    | 0*   | 8.0 | 0*   | 100 |
| Output | U3 pin 3-4 S-C   | --    | 0*   | 8.0 | 0*   | 100 |
| Output | U3 pin 1 O-C     | --    | 0*   | 8.0 | 0*   | 100 |
| Output | U3 pin 4 O-C     | --    | 0*   | 8.0 | 0*   | 100 |
| Output | RS21 S-C         | --    | 0**  | 8.0 | 0**  | 100 |

**Model: FWE050024B**

|        |                  |       |      |     |      |     |
|--------|------------------|-------|------|-----|------|-----|
| Output | Normal condition | 24.16 | 2.71 | 8.0 | 63.6 | 100 |
| Output | U2 pin 1-2 S-C   | --    | 0*   | 8.0 | 0*   | 100 |
| Output | U2 pin 3-4 S-C   | --    | 0*   | 8.0 | 0*   | 100 |
| Output | U2 pin 1 O-C     | --    | 0*   | 8.0 | 0*   | 100 |
| Output | U2 pin 4 O-C     | --    | 0*   | 8.0 | 0*   | 100 |
| Output | RS1 S-C          | --    | 0**  | 8.0 | 0**  | 100 |

Supplementary Information: S-C=Short circuit, O-C=Open circuit

\*: unit shutdown immediately.

\*\*: unit shutdown immediately, Fuse opened.

| IEC 62368-1 |                    |                 |         |
|-------------|--------------------|-----------------|---------|
| Clause      | Requirement + Test | Result - Remark | Verdict |

| T.2, T.3,<br>T.4, T.5                                    | TABLE: Steady force test |                 |           |                     |             | P |
|--|--------------------------|-----------------|-----------|---------------------|-------------|---|
| Part/Location  | Material                 | Thickness (mm)  | Force (N) | Test Duration (sec) | Observation |   |
| Internal components (according to T.2)                   | --                       | --              | 10        | 5                   | No hazard.  |   |
| No opening (according to T.3)                            | --                       | --              | --        | --                  | --          |   |
| External enclosure top, bottom, sides (according to T.4) | Plastic                  | See table 4.1.2 | 100       | 5                   | No hazard.  |   |
| External enclosure top, bottom, sides (according to T.5) | Plastic                  | See table 4.1.2 | 250       | 5                   | No hazard.  |   |
| Supplementary information: --                            |                          |                 |           |                     |             |   |

| T.6, T.9                   | TABLE: Impact tests |                |                        |  | P |
|----------------------------|---------------------|----------------|------------------------|--|---|
| Part/Location              | Material            | Thickness (mm) | Vertical distance (mm) | Observation  |   |
| Three side of enclosure    | Plastics*           | 1.5            | 1300mm                 | After the drop test, enclosure remained intact, no cracking/opening developed in the enclosure joint. Internal ES3, TS3 were not accessible after test. No insulation breakdown. |   |
| Supplementary information: |                     |                |                        |  |   |

| T.7   | TABLE: Drop tests |                |                  |             | N/A |
|---|-------------------|----------------|------------------|-------------|-----|
| Part/Location   | Material          | Thickness (mm) | Drop Height (mm) | Observation |     |
| --  | --                | --             | --               | --          |     |
| Supplementary information: *Test were performed on product with each source listed in table 4.1.2 |                   |                |                  |             |     |

| IEC 62368-1 |                    |                 |         |
|-------------|--------------------|-----------------|---------|
| Clause      | Requirement + Test | Result - Remark | Verdict |

| T.8           | TABLE: Stress relief test |                |                       |              |   | P |
|---------------|---------------------------|----------------|-----------------------|--------------|---|---|
| Part/Location | Material                  | Thickness (mm) | Oven Temperature (°C) | Duration (h) | Observation   |   |
| Enclosure     | Plastics*                 | 1.5mm          | 91                    | 7            | Enclosure remained intact, no cracking/opening developed in the enclosure joint. Internal ES3, TS3 were not accessible after test. No insulation breakdown. |   |

Supplementary information: \*Test were performed on product with each source listed in table 4.1.2



| IEC 62368-1 |                    |                 |         |
|-------------|--------------------|-----------------|---------|
| Clause      | Requirement + Test | Result - Remark | Verdict |

Appendix Table:

| TABLE: evaluation of voltage limiting components in SELV circuits |   |        | P                           |
|---|---|--------|-----------------------------|
| Component (measured between)                                      | max. voltage (V)<br>(normal operation)                      |        | Voltage Limiting Components |
|   | V peak  | V d.c. |                             |
| Model:FWE050012B  |   |        |                             |
| T1 Second pin 7 and pin 8   | 69.1  | --     | --                          |
| Component after Q1  | --  | 12.3   | --                          |
| Model: FWE050024B   |   |        |                             |
| T1 Second pin 7 and pin 8   | 128.2   | --     | --                          |
| Component after Q1  | --  | 24.2   | --                          |
| Fault test performed on voltage limiting components               | Voltage measured (V) in SELV circuits<br>(V peak or V d.c.) |        |                             |
| Model: FWE050012B   |   |        |                             |
| Short Q1 pin D-S, Output terminal                                 | 0V, unit shut down immediately, F1 opened.                  |        |                             |
| Model: FWE050024B   |   |        |                             |
| Short Q1 pin D-S, Output terminal                                 | 0V, unit shut down immediately, F1 opened.                  |        |                             |
| Output terminal (Short Q10 D to S)                                | Unit shut down immediately, F1 and F2 opened.               |        |                             |
| supplementary information:  |   |        |                             |
| Test voltage: 240V  |   |        |                             |
| Test frequency: 60 Hz   |   |        |                             |

| 5.4.1.8            | Table: working voltage measurement |                 |                                  | P |
|--------------------|------------------------------------|-----------------|----------------------------------|---|
| Location           | Peak voltage (V)                   | RMS voltage (V) | Comments                         |   |
| Model: FWE050012B  |                                    |                 |                                  |   |
| Transformer pin2-A | 265                                | 529             | --                               |   |
| Transformer pin3-A | 229                                | 498             | --                               |   |
| Transformer pin4-A | 231                                | 446             | --                               |   |
| Transformer pin5-A | 230                                | 377             | --                               |   |
| Transformer pin6-A | 208                                | 341             | --                               |   |
| Transformer pin2-B | <b>280</b>                         | <b>541</b>      | <b>Max. RMS and Peak voltage</b> |   |
| Transformer pin3-B | 234                                | 516             | --                               |   |
| Transformer pin4-B | 235                                | 509             | --                               |   |
| Transformer pin5-B | 231                                | 440             | --                               |   |
| Transformer pin6-B | 209                                | 354             | --                               |   |

| IEC 62368-1                                  |                    |                 |                          |
|--|--------------------|-----------------|--------------------------|
| Clause                                       | Requirement + Test | Result - Remark | Verdict                  |
| Photo-coupler pin1-3                         | 222                | 365             | --                       |
| Photo-coupler pin1-4                         | 221                | 361             | --                       |
| Photo-coupler pin2-3                         | 222                | 361             | --                       |
| Photo-coupler pin2-4                         | 222                | 361             | --                       |
| CY1  | 219                | 356             | --                       |
| Model: FWE050024B                            |                    |                 |                          |
| Transformer pin2-A                           | 266                | 494             | --                       |
| Transformer pin3-A                           | 217                | 450             | --                       |
| Transformer pin4-A                           | 239                | 450             | --                       |
| Transformer pin5-A                           | 237                | 387             | --                       |
| Transformer pin6-A                           | 200                | 331             | --                       |
| Transformer pin2-B                           | <b>313</b>         | 553             | <b>Max. RMS voltage</b>  |
| Transformer pin3-B                           | 261                | 496             | --                       |
| Transformer pin4-B                           | 270                | <b>600</b>      | <b>Max. Peak voltage</b> |
| Transformer pin5-B                           | 265                | 544             | --                       |
| Transformer pin6-B                           | 228                | 388             | --                       |
| Photo-coupler pin1-3                         | 232                | 414             | --                       |
| Photo-coupler pin1-4                         | 253                | 411             | --                       |
| Photo-coupler pin2-3                         | 258                | 411             | --                       |
| Photo-coupler pin2-4                         | 256                | 411             | --                       |
| CY1  | 241                | 392             | --                       |
| supplementary information:                   |                    |                 |                          |
| Test voltage: 240 V<br>Test frequency: 60 Hz |                    |                 |                          |

| IEC 62368-1 |                    |                 |         |
|-------------|--------------------|-----------------|---------|
| Clause      | Requirement + Test | Result - Remark | Verdict |

| Appended table   | TABLE: transformers |                          |                         |                            |                         |                                 |  | P |
|--|---------------------|--------------------------|-------------------------|----------------------------|-------------------------|---------------------------------|--|---|
| Loc.   | Tested insulation   | Working voltage peak / V | Working voltage rms / V | Required electric strength | Required clearance / mm | Required creepage distance / mm | Required distance thr. insul.                        |   |
| Primary winding to secondary winding   | RI                  | 600                      | 313                     | 4000 Vpeak                 | 4.5                     | 6.4                             | 0.4  |   |
| Core to secondary winding  | RI                  | 600                      | 313                     | 4000 Vpeak                 | 4.5                     | 6.4                             | 0.4  |   |
| Loc.   | Tested insulation   |                          |                         | Test voltage/ V            | Measured clearance / mm | Measured creepage dist./ mm     | Measured distance thr. insul. / mm; number of layers |   |
| Primary winding to secondary winding   | RI                  |                          |                         | 4000 Vpeak                 | 10.0                    | 10.0                            | TIW  |   |
| Core to secondary winding  | RI                  |                          |                         | 4000 Vpeak                 | 10.0                    | 10.0                            | TIW  |   |
| supplementary information:   |                     |                          |                         |                            |                         |                                 |  |   |
| Transformer description:<br>Concentric windings on phenolic bobbin. Outer winding is primary, two layers of insulation tape around outer winding. Core bottom and whole transformer were wrapped with 2 layers of insulation tape, details see photo document. Tubing provided at all winding exits. |                     |                          |                         |                            |                         |                                 |  |   |

| IEC 62368-1 |                    |                 |         |
|-------------|--------------------|-----------------|---------|
| Clause      | Requirement + Test | Result - Remark | Verdict |

Transformer No. 97660-476-aaa

MECHANICAL DIMENSION: (UNIT:mm)

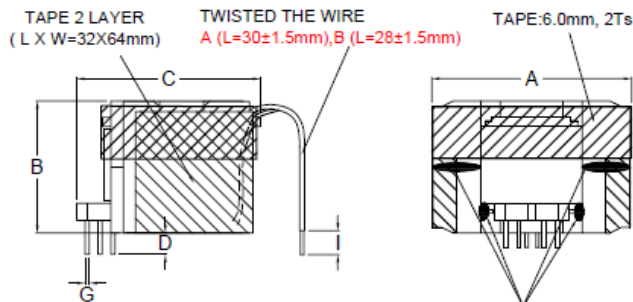

DIMENSION: (mm)

- A: 30.0 MAX
- B: 21.0 MAX
- C: 26.5 MAX
- D: 3.0±0.5
- E: 3.6±0.5
- F: 7.2±0.5
- G: 0.6±0.1
- H: 1.9 MAX
- I: 3.5±0.5

EPOXY GLUE (磁芯接合处4点+磁芯与骨架接触处4Pis)

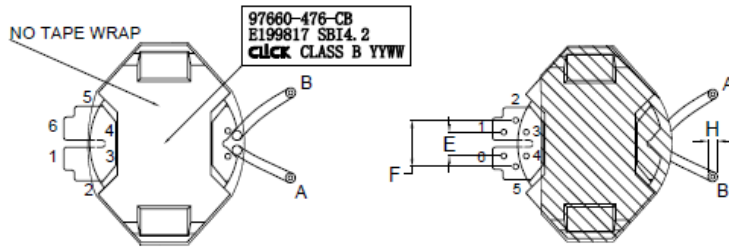

顶视图

SCHEMATIC:

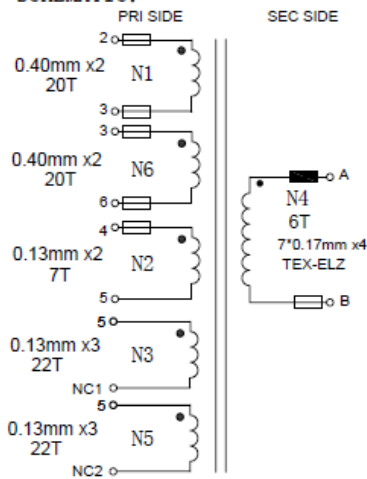

WINDING CONSTRUCTION:

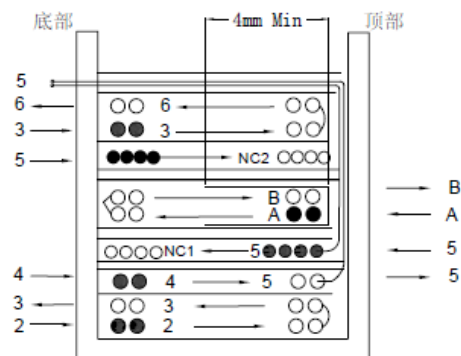

TEFLON TUBE (透明)  
TEFLON TUBE (黑色)

| IEC 62368-1 |                    |                 |         |
|-------------|--------------------|-----------------|---------|
| Clause      | Requirement + Test | Result - Remark | Verdict |

Transformer No. 97660-477-aaa

MECHANICAL DIMENSION: (UNIT:mm)

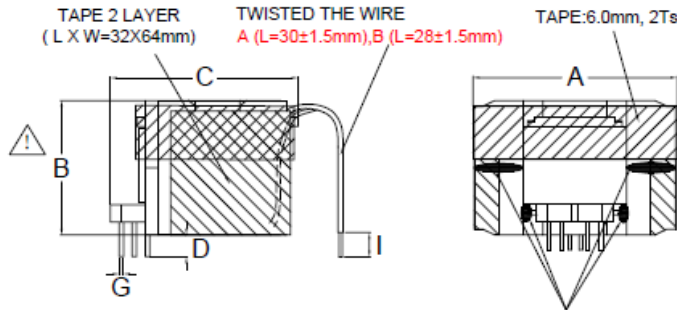

DIMENSION: (mm)

- A: 30.0 MAX
- B: 21.0 MAX
- C: 26.5 MAX
- D: 3.0±0.5
- E: 3.6±0.5
- F: 7.2±0.5
- G: 0.6±0.1
- H: 1.4 MAX
- I: 3.5±0.5

EPOXY GLUE (磁芯接合处4点+磁芯与骨架接触处4Pls)

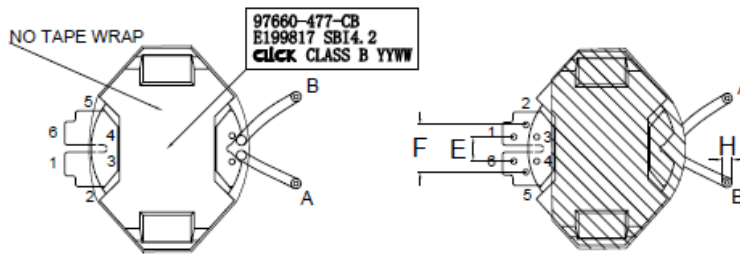

顶视图

SCHEMATIC:

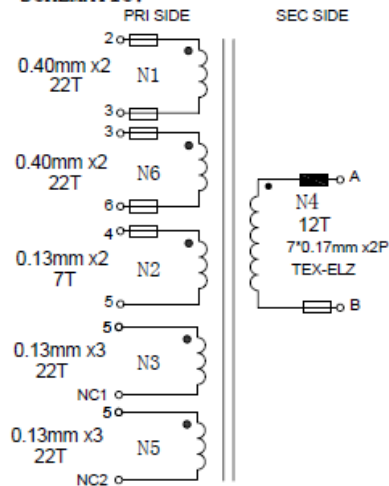

□ TEFLON TUBE (透明)  
 ■ TEFLON TUBE (黑色)

WINDING CONSTRUCTION:

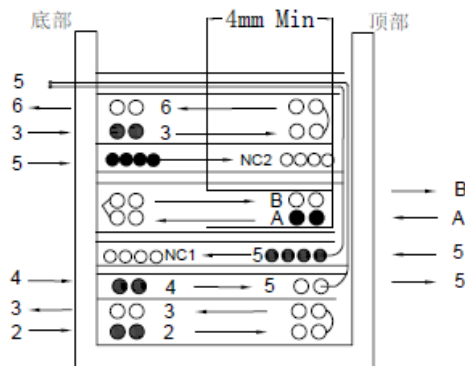

| IEC 62368-1 |                    |                 |         |
|-------------|--------------------|-----------------|---------|
| Clause      | Requirement + Test | Result - Remark | Verdict |

Transformer No. 97660-487-aaa

MECHANICAL DIMENSION: (UNIT:mm)

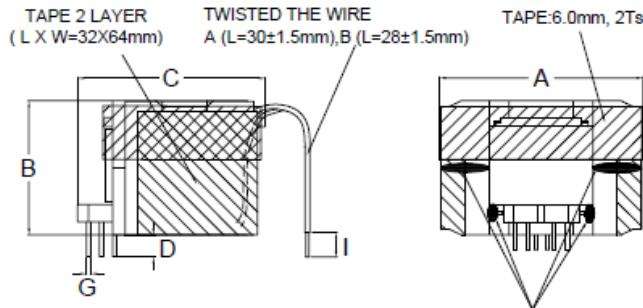

DIMENSION: (mm)

- A: 30.0 MAX
- B: 21.0 MAX
- C: 26.5 MAX
- D: 3.0±0.5
- E: 3.6±0.5
- F: 7.2±0.5
- G: 0.6±0.1
- H: 1.4 MAX
- I: 3.5±0.5

EPOXY GLUE (磁芯接合处4点+磁芯与骨架接触处4Ps)

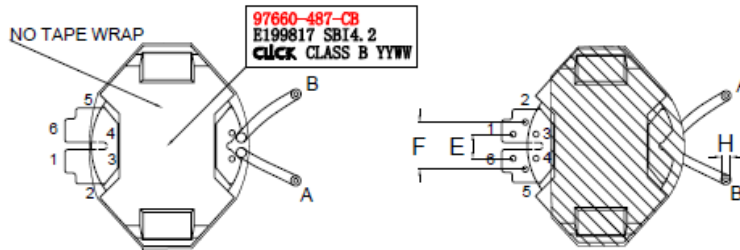

顶视图

SCHEMATIC:

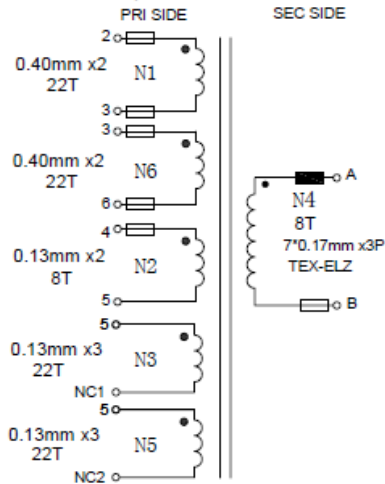

TEFLON TUBE (透明)  
TEFLON TUBE (黑色)

WINDING CONSTRUCTION:

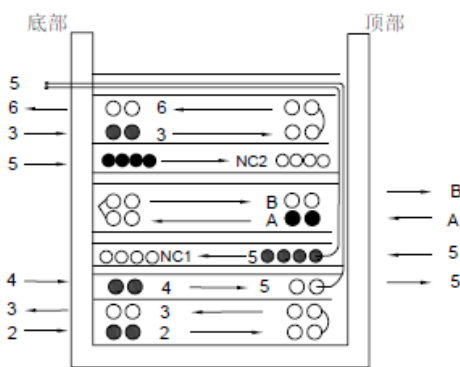

| IEC 62368-1 |                    |                 |         |
|-------------|--------------------|-----------------|---------|
| Clause      | Requirement + Test | Result - Remark | Verdict |

Transformer No. 97660-488-aaa

MECHANICAL DIMENSION: (UNIT:mm)

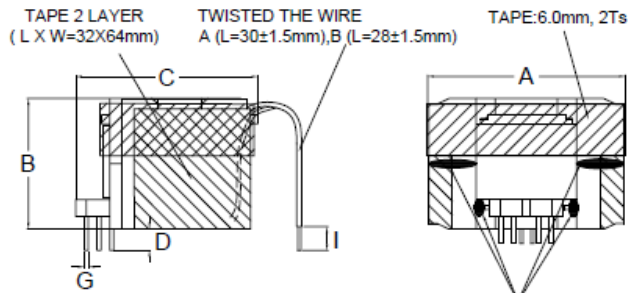

- DIMENSION: (mm)
- A: 30.0 MAX
  - B: 21.0 MAX
  - C: 26.5 MAX
  - D: 3.0±0.5
  - E: 3.6±0.5
  - F: 7.2±0.5
  - G: 0.6±0.1
  - H: 1.6 MAX
  - I: 3.5±0.5

EPOXY GLUE (磁芯接合处4点+磁芯与骨架接触处4Pis)

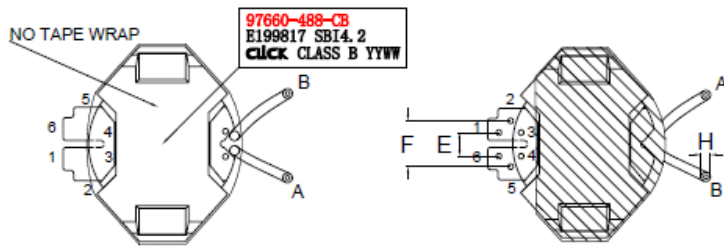

顶视图

SCHEMATIC:

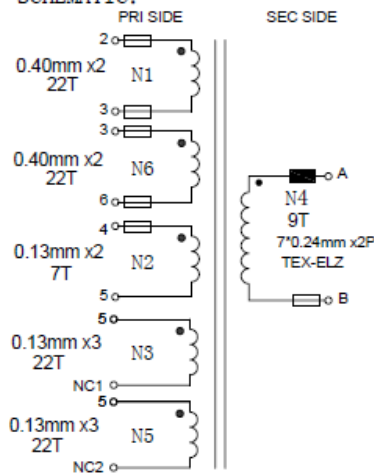

□ TEFLON TUBE (透明)  
 ■ TEFLON TUBE (黑色)

WINDING CONSTRUCTION:

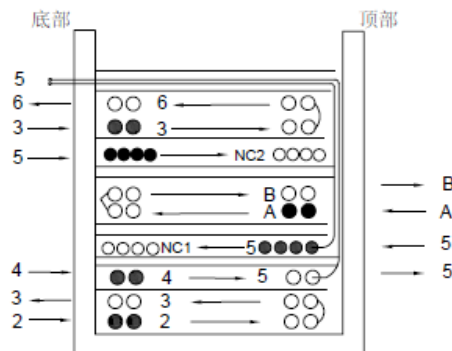

-END-

| IEC62368_1B - ATTACHMENT |                    |                 |         |
|--------------------------|--------------------|-----------------|---------|
| Clause                   | Requirement + Test | Result - Remark | Verdict |

| <b>ATTACHMENT TO TEST REPORT IEC 62368-1</b><br><b>EUROPEAN GROUP DIFFERENCES AND NATIONAL DIFFERENCES</b><br><b>(Audio/video, information and communication technology equipment Part 1: Safety requirements)</b> |                          |
|--|--------------------------|
| Differences according to.....:   | EN 62368-1:2014+A11:2017 |
| Attachment Form No.....:   | EU_GD_IEC62368_1B_II     |
| Attachment Originator.....:  | Nemko AS                 |
| Master Attachment.....:  | Date 2017-09-22          |
| <b>Copyright © 2017 IEC System for Conformity Testing and Certification of Electrical Equipment (IECEE), Geneva, Switzerland. All rights reserved.</b>   |                          |

|             |   |          |              |                         |                 |        |      |       |              |         |      |                         |        |             |              |         |        |         |      |         |      |       |      |           |              |       |      |         |              |                    |                 |        |        |          |        |         |        |  |
|-------------|---|----------|--------------|-------------------------|-----------------|--------|------|-------|--------------|---------|------|-------------------------|--------|-------------|--------------|---------|--------|---------|------|---------|------|-------|------|-----------|--------------|-------|------|---------|--------------|--------------------|-----------------|--------|--------|----------|--------|---------|--------|--|
|             | <b>CENELEC COMMON MODIFICATIONS (EN)</b>  | P        |              |                         |                 |        |      |       |              |         |      |                         |        |             |              |         |        |         |      |         |      |       |      |           |              |       |      |         |              |                    |                 |        |        |          |        |         |        |  |
|             | Clauses, subclauses, notes, tables, figures and annexes which are additional to those in IEC 62368-1:2014 are prefixed "Z".   | P        |              |                         |                 |        |      |       |              |         |      |                         |        |             |              |         |        |         |      |         |      |       |      |           |              |       |      |         |              |                    |                 |        |        |          |        |         |        |  |
| CONTENTS    | <b>Add</b> the following annexes:<br>Annex ZA (normative) Normative references to international publications with their corresponding European publications<br>Annex ZB (normative) Special national conditions<br>Annex ZC (informative) A-deviations<br>Annex ZD (informative) IEC and CENELEC code designations for flexible cords   | P        |              |                         |                 |        |      |       |              |         |      |                         |        |             |              |         |        |         |      |         |      |       |      |           |              |       |      |         |              |                    |                 |        |        |          |        |         |        |  |
|             | <b>Delete</b> all the "country" notes in the reference document (IEC 62368-1:2014) according to the following list:   | P        |              |                         |                 |        |      |       |              |         |      |                         |        |             |              |         |        |         |      |         |      |       |      |           |              |       |      |         |              |                    |                 |        |        |          |        |         |        |  |
|             | <table border="1"> <tbody> <tr> <td>0.2.1</td> <td>Note</td> <td>1</td> <td>Note 3</td> <td>4.1.15</td> <td>Note</td> </tr> <tr> <td>4.7.3</td> <td>Note 1 and 2</td> <td>5.2.2.2</td> <td>Note</td> <td>5.4.2.3.2.2<br/>Table 13</td> <td>Note c</td> </tr> <tr> <td>5.4.2.3.2.4</td> <td>Note 1 and 3</td> <td>5.4.2.5</td> <td>Note 2</td> <td>5.4.5.1</td> <td>Note</td> </tr> <tr> <td>5.5.2.1</td> <td>Note</td> <td>5.5.6</td> <td>Note</td> <td>5.6.4.2.1</td> <td>Note 2 and 3</td> </tr> <tr> <td>5.7.5</td> <td>Note</td> <td>5.7.6.1</td> <td>Note 1 and 2</td> <td>10.2.1<br/>Table 39</td> <td>Note 2, 3 and 4</td> </tr> <tr> <td>10.5.3</td> <td>Note 2</td> <td>10.6.2.1</td> <td>Note 3</td> <td>F.3.3.6</td> <td>Note 3</td> </tr> </tbody> </table> | 0.2.1    | Note         | 1                       | Note 3          | 4.1.15 | Note | 4.7.3 | Note 1 and 2 | 5.2.2.2 | Note | 5.4.2.3.2.2<br>Table 13 | Note c | 5.4.2.3.2.4 | Note 1 and 3 | 5.4.2.5 | Note 2 | 5.4.5.1 | Note | 5.5.2.1 | Note | 5.5.6 | Note | 5.6.4.2.1 | Note 2 and 3 | 5.7.5 | Note | 5.7.6.1 | Note 1 and 2 | 10.2.1<br>Table 39 | Note 2, 3 and 4 | 10.5.3 | Note 2 | 10.6.2.1 | Note 3 | F.3.3.6 | Note 3 |  |
| 0.2.1       | Note  | 1        | Note 3       | 4.1.15                  | Note            |        |      |       |              |         |      |                         |        |             |              |         |        |         |      |         |      |       |      |           |              |       |      |         |              |                    |                 |        |        |          |        |         |        |  |
| 4.7.3       | Note 1 and 2  | 5.2.2.2  | Note         | 5.4.2.3.2.2<br>Table 13 | Note c          |        |      |       |              |         |      |                         |        |             |              |         |        |         |      |         |      |       |      |           |              |       |      |         |              |                    |                 |        |        |          |        |         |        |  |
| 5.4.2.3.2.4 | Note 1 and 3  | 5.4.2.5  | Note 2       | 5.4.5.1                 | Note            |        |      |       |              |         |      |                         |        |             |              |         |        |         |      |         |      |       |      |           |              |       |      |         |              |                    |                 |        |        |          |        |         |        |  |
| 5.5.2.1     | Note  | 5.5.6    | Note         | 5.6.4.2.1               | Note 2 and 3    |        |      |       |              |         |      |                         |        |             |              |         |        |         |      |         |      |       |      |           |              |       |      |         |              |                    |                 |        |        |          |        |         |        |  |
| 5.7.5       | Note  | 5.7.6.1  | Note 1 and 2 | 10.2.1<br>Table 39      | Note 2, 3 and 4 |        |      |       |              |         |      |                         |        |             |              |         |        |         |      |         |      |       |      |           |              |       |      |         |              |                    |                 |        |        |          |        |         |        |  |
| 10.5.3      | Note 2  | 10.6.2.1 | Note 3       | F.3.3.6                 | Note 3          |        |      |       |              |         |      |                         |        |             |              |         |        |         |      |         |      |       |      |           |              |       |      |         |              |                    |                 |        |        |          |        |         |        |  |
|             | For special national conditions, see Annex ZB.  | P        |              |                         |                 |        |      |       |              |         |      |                         |        |             |              |         |        |         |      |         |      |       |      |           |              |       |      |         |              |                    |                 |        |        |          |        |         |        |  |
| 1           | <b>Add</b> the following note:<br>NOTE Z1 The use of certain substances in electrical and electronic equipment is restricted within the EU: see Directive 2011/65/EU.   | P        |              |                         |                 |        |      |       |              |         |      |                         |        |             |              |         |        |         |      |         |      |       |      |           |              |       |      |         |              |                    |                 |        |        |          |        |         |        |  |



| IEC62368_1B - ATTACHMENT |   |  |         |
|--------------------------|---|--|---------|
| Clause                   | Requirement + Test  | Result - Remark  | Verdict |
| 4.Z1                     | <p><b>Add</b> the following new subclause after 4.9:</p> <p>To protect against excessive current, short-circuits and earth faults in circuits connected to an a.c. <b>mains</b>, protective devices shall be included either as integral parts of the equipment or as parts of the building installation, subject to the following, a), b) and c):</p> <p>a) except as detailed in b) and c), protective devices necessary to comply with the requirements of B.3.1 and B.4 shall be included as parts of the equipment;</p> <p>b) for components in series with the mains input to the equipment such as the supply cord, appliance coupler, r.f.i. filter and switch, short-circuit and earth fault protection may be provided by protective devices in the building installation;</p> <p>c) it is permitted for <b>pluggable equipment type B</b> or <b>permanently connected equipment</b>, to rely on dedicated overcurrent and short-circuit protection in the building installation, provided that the means of protection, e.g. fuses or circuit breakers, is fully specified in the installation instructions.</p> <p>If reliance is placed on protection in the building installation, the installation instructions shall so state, except that for <b>pluggable equipment type A</b> the building installation shall be regarded as providing protection in accordance with the rating of the wall socket outlet.</p> | <p>Considered.</p> <p>Complied with item a) for internal fuse used and for parts as described in b) reliance on the protection in the building installation.</p> | P       |
| 5.4.2.3.2.4              | <p><b>Add</b> the following to the end of this subclause:</p> <p>The requirement for interconnection with <b>external circuit</b> is in addition given in EN 50491-3:2009.</p>  | No external circuits.  | N/A     |
| 10.2.1                   | <p><b>Add</b> the following to c) and d) in table 39:</p> <p>For additional requirements, see 10.5.1.</p>   | No such radiation from the equipment.  | N/A     |
| 10.6.1                   | <p><b>Add</b> the following paragraph to the end of the subclause:</p> <p>EN 71-1:2011, 4.20 and the related tests methods and measurement distances apply.</p>   | No such x-radiation generated from the equipment.  | N/A     |
| 10.Z1                    | <p><b>Add</b> the following new subclause after 10.6.5.</p> <p><b>10.Z1 Non-ionizing radiation from radio frequencies in the range 0 to 300 GHz</b></p> <p>The amount of non-ionizing radiation is regulated by European Council Recommendation 1999/519/EC of 12 July 1999 on the limitation of exposure of the general public to electromagnetic</p>  | No such consideration for the purpose of personal music players.   | N/A     |

| IEC62368_1B - ATTACHMENT |  |  |         |
|--------------------------|--|--|---------|
| Clause                   | Requirement + Test   | Result - Remark  | Verdict |
|                          | fields (0 Hz to 300 GHz).<br>For intentional radiators, ICNIRP guidelines should be taken into account for Limiting Exposure to Time-Varying Electric, Magnetic, and Electromagnetic Fields (up to 300 GHz). For hand-held and body-mounted devices, attention is drawn to EN 50360 and EN 50566   |  |         |
| G.7.1                    | <b>Add</b> the following note:<br>NOTE Z1 The harmonized code designations corresponding to the IEC cord types are given in Annex ZD.  |  | N/A     |
| Bibliography             | <b>Add</b> the following standards:<br><b>Add</b> the following notes for the standards indicated:<br>IEC 60130-9 NOTE Harmonized as EN 60130-9.<br>IEC 60269-2 NOTE Harmonized as HD 60269-2.<br>IEC 60309-1 NOTE Harmonized as EN 60309-1.<br>IEC 60364 NOTE some parts harmonized in HD 384/HD 60364 series.<br>IEC 60601-2-4 NOTE Harmonized as EN 60601-2-4.<br>IEC 60664-5 NOTE Harmonized as EN 60664-5.<br>IEC 61032:1997 NOTE Harmonized as EN 61032:1998 (not modified).<br>IEC 61508-1 NOTE Harmonized as EN 61508-1.<br>IEC 61558-2-1 NOTE Harmonized as EN 61558-2-1.<br>IEC 61558-2-4 NOTE Harmonized as EN 61558-2-4.<br>IEC 61558-2-6 NOTE Harmonized as EN 61558-2-6.<br>IEC 61643-1 NOTE Harmonized as EN 61643-1.<br>IEC 61643-21 NOTE Harmonized as EN 61643-21.<br>IEC 61643-311 NOTE Harmonized as EN 61643-311.<br>IEC 61643-321 NOTE Harmonized as EN 61643-321.<br>IEC 61643-331 NOTE Harmonized as EN 61643-331. |  | N/A     |
| <b>ZB</b>                | <b>ANNEX ZB, SPECIAL NATIONAL CONDITIONS (EN)</b>  |  | P       |
| 4.1.15                   | <b>Denmark, Finland, Norway and Sweden</b><br>To the end of the subclause the following is added:<br><b>Class I pluggable equipment type A</b> intended for connection to other equipment or a network shall, if safety relies on connection to reliable earthing or if surge suppressors are connected between the network terminals and <b>accessible</b> parts, have a marking stating that the equipment shall be connected to an earthed <b>mains</b> socket-outlet.<br><br>The marking text in the applicable countries shall be as follows:   | Class II equipment. Shall be evaluated during national approval. | N/A     |

| IEC62368_1B - ATTACHMENT |   |                        |         |
|--------------------------|---|------------------------|---------|
| Clause                   | Requirement + Test  | Result - Remark        | Verdict |
|                          | <p>In <b>Denmark</b>: "Apparatets stikprop skal tilsluttes en stikkontakt med jord som giver forbindelse til stikproppens jord."</p> <p>In <b>Finland</b>: "Laite on liitettävä suojakoskettimilla varustettuun pistorasiaan"</p> <p>In <b>Norway</b>: "Apparatet må tilkoples jordet stikkontakt"</p> <p>In <b>Sweden</b>: "Apparaten skall anslutas till jordat uttag"</p>  |                        |         |
| 4.7.3                    | <p><b>United Kingdom</b></p> <p>To the end of the subclause the following is added:<br/>The torque test is performed using a socket-outlet complying with BS 1363, and the plug part shall be assessed to the relevant clauses of BS 1363. Also see Annex G.4.2 of this annex</p>   | No Direct plug-in type | N/A     |
| 5.2.2.2                  | <p><b>Denmark</b></p> <p>After the 2nd paragraph add the following:<br/>A warning (marking <b>safeguard</b>) for high <b>touch current</b> is required if the <b>touch current</b> exceeds the limits of 3,5 mA a.c. or 10 mA d.c.</p>  | No high touch current. | N/A     |
| 5.4.11.1 and Annex G     | <p><b>Finland and Sweden</b></p> <p>To the end of the subclause the following is added:<br/>For separation of the telecommunication network from earth the following is applicable:<br/>If this insulation is solid, including insulation forming part of a component, it shall at least consist of either</p> <ul style="list-style-type: none"> <li>• two layers of thin sheet material, each of which shall pass the electric strength test below, or</li> <li>• one layer having a distance through insulation of at least 0,4 mm, which shall pass the electric strength test below.</li> </ul> <p>If this insulation forms part of a semiconductor component (e.g. an optocoupler), there is no distance through insulation requirement for the insulation consisting of an insulating compound completely filling the casing, so that clearances and creepage distances do not exist, if the component passes the electric strength test in accordance with the compliance clause below and in addition</p> <ul style="list-style-type: none"> <li>• passes the tests and inspection criteria of 5.4.8 with an electric strength test of 1,5 kV multiplied by 1,6 (the electric strength test of 5.4.9 shall be</li> </ul> | No TNV circuits.       | N/A     |

| IEC62368_1B - ATTACHMENT |   |                    |         |
|--------------------------|---|--------------------|---------|
| Clause                   | Requirement + Test  | Result - Remark    | Verdict |
|                          | <p>performed using 1,5 kV), and</p> <ul style="list-style-type: none"> <li>• is subject to routine testing for electric strength during manufacturing, using a test voltage of 1,5kV.</li> </ul> <p>It is permitted to bridge this insulation with a capacitor complying with EN 60384-14:2005, subclass Y2.</p> <p>A capacitor classified Y3 according to EN 60384-14:2005, may bridge this insulation under the following conditions:</p> <ul style="list-style-type: none"> <li>• the insulation requirements are satisfied by having a capacitor classified Y3 as defined by EN 60384-14, which in addition to the Y3 testing, is tested with an impulse test of 2,5 kV defined in 5.4.11;</li> <li>• the additional testing shall be performed on all the test specimens as described in EN 60384-14; the impulse test of 2,5 kV is to be performed before the endurance test in EN 60384-14, in the sequence of tests as described in EN 60384-14.</li> </ul> |                    |         |
| 5.5.2.1                  | <p><b>Norway</b></p> <p>After the 3rd paragraph the following is added:<br/>Due to the IT power system used, capacitors are required to be rated for the applicable line-to-line voltage (230 V).</p>   |                    | P       |
| 5.5.6                    | <p><b>Finland, Norway and Sweden</b></p> <p>To the end of the subclause the following is added:<br/>Resistors used as <b>basic safeguard</b> or bridging <b>basic insulation in class I pluggable equipment type A</b> shall comply with G.10.1 and the test of G.10.2.</p>   | No such resistors. | N/A     |
| 5.6.1                    | <p><b>Denmark</b></p> <p><b>Add</b> to the end of the subclause<br/>Due to many existing installations where the socket-outlets can be protected with fuses with higher rating than the rating of the socket-outlets the protection for pluggable equipment type A shall be an integral part of the equipment.</p> <p><i>Justification:</i><br/>In Denmark an existing 13 A socket outlet can be protected by a 20 A fuse.</p>  | Considered.        | P       |

| IEC62368_1B - ATTACHMENT |   |                                       |         |
|--------------------------|---|---------------------------------------|---------|
| Clause                   | Requirement + Test  | Result - Remark                       | Verdict |
| 5.6.4.2.1                | <p><b>Ireland and United Kingdom</b></p> <p>After the indent for <b>pluggable equipment type A</b>, the following is added:</p> <p>– the <b>protective current rating</b> is taken to be 13 A, this being the largest rating of fuse used in the <b>mains</b> plug.</p>   | Considered.                           | P       |
| 5.6.5.1                  | <p>To the second paragraph the following is added:</p> <p>The range of conductor sizes of flexible cords to be accepted by terminals for equipment with a rated current over 10 A and up to and including 13 A is: 1,25 mm<sup>2</sup> to 1,5 mm<sup>2</sup> in cross-sectional area.</p>   | See above.                            | N/A     |
| 5.7.5                    | <p><b>Denmark</b></p> <p>To the end of the subclause the following is added:</p> <p>The installation instruction shall be affixed to the equipment if the <b>protective conductor current</b> exceeds the limits of 3,5 mA a.c. or 10 mA d.c.</p>   | No high protective conductor current. | N/A     |
| 5.7.6.1                  | <p><b>Norway and Sweden</b></p> <p>To the end of the subclause the following is added:</p> <p>The screen of the television distribution system is normally not earthed at the entrance of the building and there is normally no equipotential bonding system within the building. Therefore the protective earthing of the building installation needs to be isolated from the screen of a cable distribution system.</p> <p>It is however accepted to provide the insulation external to the equipment by an adapter or an interconnection cable with galvanic isolator, which may be provided by a retailer, for example.</p> <p>The user manual shall then have the following or similar information in Norwegian and Swedish language respectively, depending on in what country the equipment is intended to be used in:</p> <p>“Apparatus connected to the protective earthing of the building installation through the mains connection or through other apparatus with a connection to protective earthing – and to a television distribution system using coaxial cable, may in some circumstances create a fire hazard. Connection to a television distribution system therefore has to be provided through a device providing electrical isolation below a certain frequency range (galvanic isolator, see EN 60728-11)”</p> | Not such system.                      | N/A     |

| IEC62368_1B - ATTACHMENT |  |                        |         |
|--------------------------|--|------------------------|---------|
| Clause                   | Requirement + Test   | Result - Remark        | Verdict |
|                          | <p>NOTE In Norway, due to regulation for CATV-installations, and in Sweden, a galvanic isolator shall provide electrical insulation below 5 MHz. The insulation shall withstand a dielectric strength of 1,5 kV r.m.s., 50 Hz or 60 Hz, for 1 min.</p> <p>Translation to Norwegian (the Swedish text will also be accepted in Norway):<br/>                     "Apparater som er koplet til beskyttelsesjord via nettplugg og/eller via annet jordtilkoplet utstyr – og er tilkoplet et koaksialbasert kabel-TV nett, kan forårsake brannfare. For å unngå dette skal det ved tilkopling av apparater til kabel-TV nett installeres en galvanisk isolator mellom apparatet og kabel-TV nettet."<br/>                     Translation to Swedish:<br/>                     "Apparater som är kopplad till skyddsjord via jordat vägguttag och/eller via annan utrustning och samtidigt är kopplad till kabel-TV nät kan i vissa fall medföra risk för brand. För att undvika detta skall vid anslutning av apparaten till kabel-TV nät galvanisk isolator finnas mellan apparaten och kabel-TV nätet."</p> |                        |         |
| 5.7.6.2                  | <p><b>Denmark</b><br/>                     To the end of the subclause the following is added:<br/>                     The warning (marking safeguard) for high touch current is required if the touch current or the protective current exceed the limits of 3,5 mA .</p>  | No external circuits.  | N/A     |
| B.3.1 and B.4            | <p><b>Ireland and United Kingdom</b><br/>                     The following is applicable:<br/>                     To protect against excessive currents and short-circuits in the primary circuit of <b>direct plug-in equipment</b>, tests according to Annexes B.3.1 and B.4 shall be conducted using an external miniature circuit breaker complying with EN 60898-1, Type B, rated 32A. If the equipment does not pass these tests, suitable protective devices shall be included as an integral part of the <b>direct plug-in equipment</b>, until the requirements of Annexes B.3.1 and B.4 are met</p>  | No Direct plug-in type | N/A     |
| G.4.2                    | <p><b>Denmark</b><br/>                     To the end of the subclause the following is added:<br/>                     Supply cords of single phase appliances having a rated current not exceeding 13 A shall be provided with a plug according to DS 60884-2-D1:2011.<br/>                     CLASS I EQUIPMENT provided with socket-outlets with earth contacts or which are intended to be used in</p>   |                        | N/A     |

| IEC62368_1B - ATTACHMENT |   |                        |         |
|--------------------------|---|------------------------|---------|
| Clause                   | Requirement + Test  | Result - Remark        | Verdict |
|                          | <p>locations where protection against indirect contact is required according to the wiring rules shall be provided with a plug in accordance with standard sheet DK 2-1a or DK 2-5a.</p> <p>If a single-phase equipment having a RATED CURRENT exceeding 13 A or if a poly-phase equipment is provided with a supply cord with a plug, this plug shall be in accordance with the standard sheets DK 6-1a in DS 60884-2-D1 or EN 60309-2.</p> <p>Mains socket outlets intended for providing power to Class II apparatus with a rated current of 2,5 A shall be in accordance DS 60884-2-D1:2011 standard sheet DKA 1-4a.</p> <p>Other current rating socket outlets shall be in compliance with Standard Sheet DKA 1-3a or DKA 1-1c.</p> <p>Mains socket-outlets with earth shall be in compliance with DS 60884-2-D1:2011 Standard Sheet DK 1-3a, DK 1-1c, DK1-1d, DK 1-5a or DK 1-7a</p> <p><i>Justification:</i><br/>Heavy Current Regulations, Section 6c</p> |                        |         |
| G.4.2                    | <p><b>United Kingdom</b></p> <p>To the end of the subclause the following is added:</p> <p>The plug part of direct plug-in equipment shall be assessed to BS 1363: Part 1, 12.1, 12.2, 12.3, 12.9, 12.11, 12.12, 12.13, 12.16, and 12.17, except that the test of 12.17 is performed at not less than 125 °C. Where the metal earth pin is replaced by an Insulated Shutter Opening Device (ISOD), the requirements of clauses 22.2 and 23 also apply.</p>  | No Direct plug-in type | N/A     |
| G.7.1                    | <p><b>United Kingdom</b></p> <p>To the first paragraph the following is added:</p> <p>Equipment which is fitted with a flexible cable or cord and is designed to be connected to a mains socket conforming to BS 1363 by means of that flexible cable or cord shall be fitted with a 'standard plug' in accordance with the Plugs and Sockets etc (Safety) Regulations 1994, Statutory Instrument 1994 No. 1768, unless exempted by those regulations.</p> <p>NOTE "Standard plug" is defined in SI 1768:1994 and essentially means an approved plug conforming to BS 1363 or an approved conversion plug.</p>  |                        | N/A     |

| IEC62368_1B - ATTACHMENT |  |                              |         |
|--------------------------|--|------------------------------|---------|
| Clause                   | Requirement + Test   | Result - Remark              | Verdict |
| G.7.1                    | <p><b>Ireland</b></p> <p>To the first paragraph the following is added:<br/>Apparatus which is fitted with a flexible cable or cord shall be provided with a plug in accordance with Statutory Instrument 525: 1997, "13 A Plugs and Conversion Adapters for Domestic Use Regulations: 1997. S.I. 525 provides for the recognition of a standard of another Member State which is equivalent to the relevant Irish Standard</p>  |                              | N/A     |
| G.7.2                    | <p><b>Ireland and United Kingdom</b></p> <p>To the first paragraph the following is added:<br/>A power supply cord with a conductor of 1,25 mm<sup>2</sup> is allowed for equipment which is rated over 10 A and up to and including 13 A.</p>   |                              | N/A     |
| <b>ZC</b>                | <b>ANNEX ZC, NATIONAL DEVIATIONS (EN)</b>  |                              |         |
| 10.5.2                   | <p><b>Germany</b></p> <p>The following requirement applies:<br/>For the operation of any cathode ray tube intended for the display of visual images operating at an acceleration voltage exceeding 40 kV, authorization is required, or application of type approval (Bauartzulassung) and marking.</p> <p><i>Justification:</i><br/>German ministerial decree against ionizing radiation (Röntgenverordnung), in force since 2002-07-01, implementing the European Directive 96/29/EURATOM.</p> <p><b>NOTE</b> Contact address:<br/>Physikalisch-Technische Bundesanstalt, Bundesallee 100,<br/>D-38116 Braunschweig,<br/>Tel.: Int +49-531-592-6320,<br/>Internet: <a href="http://www.ptb.de">http://www.ptb.de</a></p> | No CRT within the equipment. | N/A     |





| IEC62368_1B - ATTACHMENT |                    |                 |         |
|--------------------------|--------------------|-----------------|---------|
| Clause                   | Requirement + Test | Result - Remark | Verdict |

|  |
|--|
| <p><b>ATTACHMENT TO TEST REPORT IEC 62368-1</b><br/> <b>DENMARK NATIONAL DIFFERENCES</b><br/>                 Audio/video, information and communication technology equipment –<br/>                 Part 1: Safety requirements</p> |
| <p><b>Differences according to</b>.....: DS/EN 62368-1:2014</p>  |
| <p><b>Attachment Form No.</b>.....: DK_ND_IEC62368_1B</p>  |
| <p><b>Attachment Originator</b> .....: UL (Demko)</p>  |
| <p><b>Master Attachment</b> .....: 2014-10</p>   |
| <p><b>Copyright © 2014 IEC System for Conformity Testing and Certification of Electrical Equipment (IECEE), Geneva, Switzerland. All rights reserved.</b></p>  |

|         | National Differences   |  |     |
|---------|--|--|-----|
| 4.1.15  | <p>To the end of the subclause the following is added:</p> <p>Class I pluggable equipment type A intended for connection to other equipment or a network shall, if safety relies on connection to reliable earthing or if surge suppressors are connected between the network terminals and accessible parts, have a marking stating that the equipment shall be connected to an earthed mains socket-outlet.</p> <p>The marking text in the applicable countries shall be as follows:</p> <p>“Apparatets stikprop skal tilsluttes en stikkontakt med jord som giver forbindelse til stikproppens jord.”</p> |  | N/A |
| 5.2.2.2 | <p>After the 2nd paragraph add the following:</p> <p>A warning (marking safeguard) for high touch current is required if the touch current exceeds the limits of 3,5 mA a.c. or 10 mA d.c.</p>   |  | N/A |
| 5.6.1   | <p>Add to the end of the subclause:</p> <p>Due to many existing installations where the socket-outlets can be protected with fuses with higher rating than the rating of the socket-outlets the protection for pluggable equipment type A shall be an integral part of the equipment.</p> <p>Justification:</p> <p>In Denmark an existing 13 A socket outlet can be protected by a 20 A fuse.</p>  |  | N/A |

| IEC62368_1B - ATTACHMENT |  |                 |         |
|--------------------------|--|-----------------|---------|
| Clause                   | Requirement + Test   | Result - Remark | Verdict |
| 5.7.5                    | To the end of the subclause the following is added:<br>The installation instruction shall be affixed to the equipment if the protective conductor current exceeds the limits of 3,5 mA a.c. or 10 mA d.c.  |                 | N/A     |
| 5.7.6.2                  | To the end of the subclause the following is added:<br>The warning (marking safeguard) for high touch current is required if the touch current or the protective current exceed the limits of 3,5 mA.  |                 | N/A     |
| G.4.2                    | To the end of the subclause the following is added:<br>Supply cords of single phase appliances having a rated current not exceeding 13 A shall be provided with a plug according to DS 60884-2-D1:2011.<br>CLASS I EQUIPMENT provided with socket-outlets with earth contacts or which are intended to be used in locations where protection against indirect contact is required according to the wiring rules shall be provided with a plug in accordance with standard sheet DK 2-1a or DK 2-5a.<br>If a single-phase equipment having a RATED CURRENT exceeding 13 A or if a poly-phase equipment is provided with a supply cord with a plug, this plug shall be in accordance with the standard sheets DK 6-1a in DS 60884-2-D1 or EN 60309-2.<br>Mains socket outlets intended for providing power to Class II apparatus with a rated current of 2,5 A shall be in accordance DS 60884-2-D1:2011 standard sheet DKA 1-4a.<br>Other current rating socket outlets shall be in compliance with Standard Sheet DKA 1-3a or DKA 1-1c.<br>Mains socket-outlets with earth shall be in compliance with DS 60884-2-D1:2011 Standard Sheet DK 1-3a, DK 1-1c, DK1-1d, DK 1-5a or DK 1-7a<br>Justification:<br>Heavy Current Regulations, Section 6c |                 | N/A     |



| IEC62368_1B - ATTACHMENT |                    |                 |         |
|--------------------------|--------------------|-----------------|---------|
| Clause                   | Requirement + Test | Result - Remark | Verdict |

| <b>ATTACHMENT TO TEST REPORT IEC 62368-1 2<sup>th</sup> Ed.</b><br><b>U.S.A. NATIONAL DIFFERENCES</b><br>Audio/video, information and communication technology equipment – Part 1: Safety requirements |                     |
|--|---------------------|
| <b>Differences according to.....:</b>  | CSA/UL 62368-1:2014 |
| <b>Attachment Form No.....:</b>  | US&CA_ND_IEC623681B |
| <b>Attachment Originator.....:</b>   | UL(US)              |
| <b>Master Attachment.....:</b>   | Date 2015-06        |
| <b>Copyright © 2015 IEC System for Conformity Testing and Certification of Electrical Equipment (IECEE), Geneva, Switzerland. All rights reserved.</b>   |                     |

| <b>IEC 62368-1 - US and Canadian National Differences</b><br><b>Special National Conditions based on Regulations and Other National Differences</b> |   |   |     |
|---|---|---|-----|
| 1.1   | All equipment is to be designed to allow installation according to the National Electrical Code (NEC), ANSI/NFPA 70, the Canadian Electrical Code (CEC), Part I, CAN/CSA C22.1, and when applicable, the National Electrical Safety Code, IEEE C2.<br>Also, for such equipment marked or otherwise identified, installation is allowed per the Standard for the Protection of Information Technology Equipment, ANSI/NFPA 75. | In accordance with the National Electrical Code (NEC) and the Canadian Electrical Code (CEC) part 1 CAN/CSA C22.1, ANSI/NFPA 70, and unless marked or otherwise identified, the Standard for Electronic Computer/Data-Processing Equipment, ANSI/NFPA 75. | P   |
| 1.4   | Additional requirements apply to some forms of power distribution equipment, including sub-assemblies.  | Considered.   | P   |
| 4.1.17  | For lengths exceeding 3.05 m, external interconnecting flexible cord and cable assemblies are required to be a suitable cable type (e.g., DP, CL2) specified in the NEC.  |   | N/A |
|   | For lengths 3.05 m or less, external interconnecting flexible cord and cable assemblies that are not types specified in the NEC generally are required to have special construction features and identification markings.   | See above.  | N/A |
| 4.8   | Lithium coin / button cell batteries have modified special construction and performance requirements.   | No such batteries.  | N/A |

| IEC62368_1B - ATTACHMENT |   |   |         |
|--------------------------|---|---|---------|
| Clause                   | Requirement + Test  | Result - Remark   | Verdict |
| 5.6.3                    | Protective earthing conductors comply with the minimum conductor sizes in Table G.5, except as required by Table G.7ADV.1 for cord connected equipment, or Annex DVH for permanently connected equipment  | Class II  | N/A     |
| 5.7.7                    | Equipment intended to receive telecommunication ringing signals complies with a special touch current measurement tests.  | No TNV circuits within the equipment.                             | N/A     |
| 6.5.1                    | PS3 wiring outside a fire enclosure complies with single fault testing in B.4, or be current limited per one of the permitted methods.  | No such parts.  | N/A     |
| Annex F (F.3.3.8)        | Output terminals provided for supply of other equipment, except mains, supply are marked with a maximum rating or references to which equipment it is permitted to be connected.  | DC output connector is provided. Indicated by User specification. | P       |
| Annex G (G.7.1)          | Permanent connection of equipment to the mains supply by a power supply cord is not permitted, except for certain equipment, such as ATMs.  | The equipment is not permanent connection equipment.              | N/A     |
| Annex G (G.7.3)          | Power supply cords are required to have attachment plugs rated not less than 125 percent of the rated current of the equipment.   |   | N/A     |
|                          | Flexible power supply cords are required to be compatible with Article 400 of the NEC, and Tables 11 and 12 of the CEC.   | See above.  | N/A     |
| Annex G (G.7.5)          | Minimum cord length is required to be 1.5 m, with certain constructions such as external power supplies allowed to consider both input and output cord lengths into the requirement. Power supply cords are required to be no longer than 4.5 m in length if used in ITE Rooms.   | See above.  | N/A     |
| Annex H.2                | Continuous ringing signals under normal operating conditions up to 16 mA only are permitted if the equipment is subjected to special installation and performance restrictions.   | No TNV circuits within the equipment.                             | N/A     |
| Annex H.4                | For circuits with other than ringing signals and with voltages exceeding 42.4 V <sub>peak</sub> or 60 V d.c., the maximum acceptable current through a 2000 ohm resistor (or greater) connected across the voltage source with other loads disconnected is 7.1 mA peak or 30 mA d.c. under normal operating conditions. | No TNV circuits within the equipment.                             | N/A     |
| Annex M                  | Battery packs for stationary applications comply with special component requirements.   | No such parts.  | N/A     |

| IEC62368_1B - ATTACHMENT |  |   |         |
|--------------------------|--|---|---------|
| Clause                   | Requirement + Test   | Result - Remark   | Verdict |
| Annex DVA (1)            | Equipment intended for use in spaces used for environmental air are subjected to special flammability requirements for heat and visible smoke release.   | The equipment not intended to be used within such environments. | N/A     |
|                          | For ITE room applications, automated information storage systems with combustible media greater than 0.76 m <sup>3</sup> (27 cu ft) have a provision for connection of either automatic sprinklers or a gaseous agent extinguishing system with an extended discharge.   | Not such equipment.   | N/A     |
|                          | Consumer products designed or intended primarily for children 12 years of age or younger are subject to additional requirements in accordance with U.S. & Canadian Regulations.  | The equipment is not for children used.                         | N/A     |
|                          | Baby monitors additionally comply with ASTM F2951, Consumer Safety Specification for Baby Monitors.  | Not a baby monitors.  | N/A     |
| Annex DVA (5.6.3)        | For Pluggable Equipment Type A, the protection in the installation is assumed to be 20A.   | Considered.   | P       |
| Annex DVA (6.3)          | The maximum quantity of flammable liquid stored in equipment complies with NFPA 30.  | No flammable liquids within the equipment.                      | N/A     |
| Annex DVA (6.4.8)        | For ITE room applications, enclosures with combustible material measuring greater than 0.9 m <sup>2</sup> (10 sq ft) or a single dimension greater than 1.8 m (6 ft) have a flame spread rating of 50 or less. For equipment with the same dimensions for other applications, an external surface that is not a fire enclosure requires a min. flammability classification of V-1. | No such application.  | N/A     |
| Annex DVA (10.3.1)       | Equipment with lasers meets the U.S. Code of Federal Regulations 21 CFR 1040 (and the Canadian Radiation Emitting Devices Act, REDR C1370).  | No such parts.  | N/A     |
| Annex DVA (10.5.1)       | Equipment that produces ionizing radiation complies with the U.S. Code of Federal Regulations, 21 CFR 1020 (and the Canadian Radiation Emitting Devices Act, REDR C1370).  | No such parts.  | N/A     |

| IEC62368_1B - ATTACHMENT |  |   |         |
|--------------------------|--|---|---------|
| Clause                   | Requirement + Test   | Result - Remark   | Verdict |
| Annex DVA (F.3.3.3)      | Equipment for use on a.c. mains supply systems with a neutral and more than one phase conductor (e.g. 120/240 V, 3-wire) require a special marking format for electrical ratings. Additional considerations apply for voltage ratings that exceed the attachment cap rating or are lower than the "Normal Operating Condition" in Table 2 of CAN/CSA C22.2 No. 235." | Single phase only.  | N/A     |
| Annex DVA (F.3.3.5)      | Equipment identified for ITE (computer) room installation is marked with the rated current   | Not such application.   | N/A     |
| Annex DVA (G.1)          | Vertically-mounted disconnect switches and circuit breakers have the "on" position indicated by the handle in the up position  | No such parts.  | N/A     |
| Annex DVA (G.3.4)        | Suitable NEC/CEC branch circuit protection rated at the maximum circuit rating is required for all standard supply outlets and receptacles (such as supplied in power distribution units) if the supply branch circuit protection is not suitable.   | No standard supply outlets, receptacles, medium-base or smaller lampholders provided. | N/A     |
| Annex DVA (G.4.2)        | Equipment with isolated ground (earthing) receptacles complies with NEC 250.146(D) and CEC 10-112 and 10-906(8).   | No such parts.  | N/A     |
| Annex DVA (G.4.3)        | Where a fuse is used to provide Class 2 or Class 3 current limiting, it is not operator-accessible unless it is non- interchangeable.  | No such parts.  | N/A     |
| Annex DVA (G.5.3)        | Power distribution transformers distributing power at 100 volts or more, and rated 10 kVA or more, require special transformer overcurrent protection.   | No such parts.  | N/A     |
| Annex DVA (G.5.4)        | Motor control devices are required for cord-connected equipment with a mains-connected motor if the equipment is rated more than 12 A, or if the equipment has a nominal voltage rating greater than 120 V, or if the motor is rated more than 1/3 hp (locked rotor current over 43 A).  | No such parts.  | N/A     |
| Annex DVA (Annex M)      | For ITE room applications, equipment with battery systems capable of supplying 750 VA for five minutes have a battery disconnect means that may be connected to the ITE room remote power-off circuit.   | Not such application.   | N/A     |
| Annex DVA (Q)            | Wiring terminals intended to supply Class 2 outputs according to the NEC or CEC Part 1 are marked with the voltage rating and "Class 2" or equivalent; marking is located adjacent to the terminals and visible during wiring.   | Not applicable for the equipment.   | N/A     |

| IEC62368_1B - ATTACHMENT |   |   |         |
|--------------------------|---|---|---------|
| Clause                   | Requirement + Test  | Result - Remark   | Verdict |
| Annex DVB (1)            | Additional requirements apply for equipment used for entertainment purposes intended for installation in general patient care areas of health care facilities.  | Not such application.   | N/A     |
| Annex DVC (1)            | Additional requirements apply for equipment intended for mounting under kitchen cabinets.   | Not such application.   | N/A     |
| Annex DVE (4.1.1)        | Some equipment, components, sub-assemblies and materials associated with the risk of fire, electric shock, or personal injury have component or material ratings in accordance with the applicable national (U.S. and Canadian) component or material requirements.<br>Components required to comply include: appliance couplers, attachment plugs, battery back-up systems, battery packs, circuit breakers, communication circuit accessories, connectors (used for current interruption of non-LPS circuits), power supply cords, direct plug-in equipment, electrochemical capacitor modules (energy storage modules with ultra-capacitors), enclosures (outdoor), flexible cords and cables, fuses (branch circuit), ground-fault current interrupters, interconnecting cables, data storage equipment, printed wiring, protectors for communications circuits, receptacles, surge protective devices, vehicle battery adapters, wire connectors, and wire and cables. | UL approved components used. Refer to table 4.1.2 of IEC 62368-1 test report for details. | P       |
| Annex DVH                | Equipment for permanent connection to the mains supply is subjected to additional requirements.   | The equipment is not permanently connected equipment.                                     | N/A     |
| Annex DVH (DVH.1)        | Wiring methods (terminals, leads, etc.) used for the connection of the equipment to the mains are in accordance with the NEC/CEC.   | Pluggable equipment type A.   | N/A     |
| Annex DVH (DVH.3.2)      | Terminals for permanent wiring, including protective earthing terminals, are suitable for U.S./Canadian wire gauge sizes, rated 125 percent of the equipment rating, and are specially marked when specified.   | No terminals for permanent wiring.  | N/A     |
| Annex DVH (DVH.3.2)      | Wire binding screws are not permitted to attach conductors larger than 10 AWG (5.3 mm <sup>2</sup> ).   | No wire binding screws.   | N/A     |
| Annex DVH (DVH.4)        | Permanently connected equipment is required to have a suitable wiring compartment and wire bending space.   | The equipment is not permanently connected equipment.                                     | N/A     |

| IEC62368_1B - ATTACHMENT |  |   |         |
|--------------------------|--|---|---------|
| Clause                   | Requirement + Test   | Result - Remark   | Verdict |
| Annex DVH (DVH 5.5)      | Equipment connected to a centralized d.c. power system, and having one pole of the DC mains input terminal connected to the main protective earthing terminal in the equipment, complies with special earthing, wiring, marking and installation instruction requirements. | The equipment not connected to a centralized d.c. power system. | N/A     |
| Annex DVI (6.7 )         | Equipment intended for connection to telecommunication network outside plant cable is required to be protected against overvoltage from power line crosses.  | No TNV circuits within the equipment.                           | N/A     |
| Annex DVJ (10.6.1 )      | Equipment connected to a telecommunication and cable distribution networks and supplied with an earphone intended to be held against, or in the ear is required to comply with special acoustic pressure requirements.   | No TNV circuits within the equipment.                           | N/A     |





| IEC62368_1B - ATTACHMENT |                    |                 |         |
|--------------------------|--------------------|-----------------|---------|
| Clause                   | Requirement + Test | Result - Remark | Verdict |

| ATTACHMENT TO TEST REPORT   |   |  |   |
|---|---|--|---|
| IEC 62368-1<br>(AUSTRALIA / NEW ZEALAND) NATIONAL DIFFERENCES<br>(Audio/video, information and communication technology equipment)              |   |  |   |
| Differences according to ..... : AS/NZS 62368.1:2018  |   |  |   |
| Attachment Form No..... : AU_NZ_ND_IEC62368_1B  |   |  |   |
| Attachment Originator ..... : JAS-ANZ   |   |  |   |
| Master Attachment..... : 2019-02-04   |   |  |   |
| Copyright © 2019 IEC System for Conformity Testing and Certification of Electrical Equipment (IECEE), Geneva, Switzerland. All rights reserved. |   |  |   |
|   | <b>National Differences</b>   |  |   |
| <b>Appendix ZZ</b>  | Variations to IEC 62368-1:2014 (ED. 2.0) for Australia and New Zealand  |  | P |
| <b>ZZ1 Scope</b>  | This Appendix lists the normative variations to IEC 62368-1:2014 (ED. 2.0)  |  | P |
| <b>ZZ2 Variations</b>   | The following modifications are required for Australian/New Zealand conditions:   |  | P |
| <b>2</b>  | Add the following to the list of normative references:<br>The following normative documents are referenced in Appendix ZZ:<br>-AS/NZS 3112, <i>Approval and test specification—Plugs and socket-outlets</i><br>-AS/NZS 3123, <i>Approval and test specification—Plugs, socket-outlets and couplers for general industrial application</i><br>-AS/NZS 3191, <i>Electric flexible cords</i><br>-AS/NZS 60065, <i>Audio, video and similar electronic apparatus—Safety requirements (IEC 60065:2015 (ED.8.0) MOD)</i><br>-AS/NZS 60320.1, <i>Appliance couplers for household and similar general purposes, Part 1: General requirements (IEC 60320-1, Ed.2.1 (2007) MOD)</i><br>-AS/NZS 60320.2.2, <i>Appliance couplers for household and similar general purposes Part 2.2: Interconnection couplers for household and similar equipment (IEC 60320-2-2, Ed.2.0 (1998) MOD)</i> |  | P |

| IEC62368_1B - ATTACHMENT |   |                 |         |
|--------------------------|---|-----------------|---------|
| Clause                   | Requirement + Test  | Result - Remark | Verdict |
|                          | <p>-AS/NZS 60695.2.11, <i>Fire hazard testing, Part 2.11: Glowing/hot wire based test methods—Glow-wire flammability test method for end-products</i></p> <p>-AS/NZS 60695.11.5, <i>Fire hazard testing, Part 11.5: Test flames—Needle-flame test method—Apparatus, confirmatory test arrangement and guidance</i></p> <p>-AS/NZS 60695.11.10, <i>Fire hazard testing, Part 11.10: Test flames—50 W horizontal and vertical flame test methods</i></p> <p>-AS/NZS 60884.1, <i>Plugs and socket-outlets for household and similar purposes, Part 1: General requirements</i></p> <p>-AS/NZS 60950.1:2015, <i>Information technology equipment—Safety, Part 1: General requirements (IEC 60950-1, Ed.2.2 (2013), MOD)</i></p> <p>IEC 61032:1997, <i>Protection of persons and equipment by enclosures—Probes for verification</i></p> <p>-AS/NZS 61558.1:2008 (including Amendment 2:2015), <i>Safety of Power Transformers, Power Supplies, Reactors and Similar Products, Part 1: General requirements and tests (IEC 61558-1 Ed 2.1, MOD)</i></p> <p>-AS/NZS 61558.2.16, <i>Safety of transformers, reactors, power supply units and similar products for voltages up to 1 100 V, Part 2.16: Particular requirements and tests for switch mode power supply units and transformers for switch mode power supply units.</i></p> |                 |         |
| 4.1.1                    | <p><b>Application of requirements and acceptance of materials, components and subassemblies</b></p> <p>1 <i>Replace the text 'IEC 60950-1' with 'AS/NZS 60950.1:2015'.</i></p> <p>2 <i>Replace the text 'IEC 60065' with 'AS/NZS 60065'.</i></p>  |                 | P       |

| IEC62368_1B - ATTACHMENT |   |                        |         |
|--------------------------|---|------------------------|---------|
| Clause                   | Requirement + Test  | Result - Remark        | Verdict |
| <b>4.7</b>               | <b>Equipment for direct insertion into mains socket-outlets</b>   |                        | N/A     |
| <b>4.7.2</b>             | <p><b>Requirements</b></p> <p><i>Delete</i> the text of the second paragraph and <i>replace</i> with the following:</p> <p>Equipment with a plug portion, suitable for insertion into a 10 A 3-pin flat-pin socket-outlet complying with AS/NZS 3112 shall comply with the requirements in AS/NZS 3112 for equipment with integral pins for insertion into socket-outlets.</p>  | No Direct plug-in type | N/A     |
| <b>4.7.3</b>             | <p><b>Compliance Criteria</b></p> <p><i>Delete</i> the first paragraph and Note 1 and Note 2 and <i>replace</i> with the following:</p> <p><i>Compliance is checked by inspection and, if necessary, by the tests in AS/NZS 3112.</i></p>   | No Direct plug-in type | N/A     |
| <b>4.8</b>               | <p><i>Delete</i> existing clause title and <i>replace</i> with the following:</p> <p><b>4.8 Products containing coin/button cell batteries</b></p>  |                        | N/A     |
| <b>4.8.1</b>             | <p><b>General</b></p> <p>1 Second dashed point, <i>delete</i> the text and <i>replace</i> with the following:</p> <p>– include coin/button cell batteries with a diameter of 32 mm or less.</p> <p>2 After the second dashed point, <i>insert</i> the following Note:</p> <p>NOTE 1: Batteries are specified in IEC 60086-2.</p> <p>3 After the third dashed point, <i>renumber</i> the existing Note as 'NOTE 2'.</p> <p>4 Fifth dashed point, <i>delete</i> the word 'lithium'.</p> |                        | N/A     |
| <b>4.8.2</b>             | <p><b>Instructional Safeguard</b></p> <p>First line, <i>delete</i> the word 'lithium'.</p>  |                        | N/A     |
| <b>4.8.3</b>             | <p><b>Construction</b></p> <p>First line, after the word 'Equipment' <i>insert</i> the words 'containing one or more coin/button batteries and'</p>   |                        | N/A     |

| IEC62368_1B - ATTACHMENT |  |                               |   |                          |
|--------------------------|--|-------------------------------|---|--------------------------|
| Clause                   | Requirement + Test   |                               | Result - Remark   | Verdict                  |
| <b>4.8.5</b>             | <b>Compliance criteria</b><br><i>Delete the first paragraph and replace with the following:<br/>Compliance is checked by applying a force of 30 N +/- 1 N for 10 s to the battery compartment door/cover by a rigid test finger according to test probe 11 of IEC 61032:1997 at the most unfavourable place and in the most unfavourable direction. The force shall be applied in one direction at a time.</i> |                               |   | N/A                      |
| <b>5.4.10.2</b>          | <b>Test methods</b>  |                               |   | N/A                      |
| <b>5.4.10.2.1</b>        | <b>General</b><br><i>Delete the first paragraph and replace with the following:<br/>In Australia only, the separation is checked by the test of both Clause 5.4.10.2.2 and Clause 5.4.10.2.3. In New Zealand, the separation is checked by the test of either Clause 5.4.10.2.2 or Clause 5.4.10.2.3.</i>  |                               |   | N/A                      |
| <b>Table 29</b>          | <i>Replace the table with the following:</i>   |                               |   | N/A                      |
|                          | Parts  | Impulse test                  |   | Steady state test        |
|                          |  | New Zealand                   | Australia   | New Zealand<br>Australia |
|                          | Parts indicated in Clause 5.4.10.1 a) <sup>a</sup>   | 2.5 kV<br>10/700 µs           | 7.0 kV for hand-held telephones and headsets, 2.5 kV for other equipment. 10/700 µs | 1.5 kV<br>3 kV           |
|                          | Parts indicated in Clause 5.4.10.1 b) and c) <sup>b</sup>  | 1.5 kV 10/700 µs <sup>c</sup> |   | 1.0 kV<br>1.5 kV         |
|                          | <sup>a</sup> Surge suppressors shall not be removed.<br><sup>b</sup> Surge suppressors may be removed, provided that such devices pass the impulse test of Clause 5.4.10.2.2 when tested as components outside the equipment.<br><sup>c</sup> During this test, it is allowed for a surge suppressor to operate and for a sparkover to occur in a GDT.   |                               |   |                          |

| IEC62368_1B - ATTACHMENT |   |                 |         |
|--------------------------|---|-----------------|---------|
| Clause                   | Requirement + Test  | Result - Remark | Verdict |
| <b>5.4.10.2.2</b>        | After the first paragraph, <i>insert</i> new Notes 201 and 202 as follows:<br>NOTE 201 For Australia, the 7 kV impulse simulates lightning surges on typical rural and semi-rural network lines.<br>NOTE 202 For Australia, the value of 2.5 kV for Clause 5.4.10.1 a) was chosen to ensure the adequacy of the insulation concerned and does not necessarily simulate likely overvoltages. |                 | N/A     |
| <b>5.4.10.2.3</b>        | After the first paragraph, <i>insert</i> new Notes 201 and 202 as follows:<br>NOTE 201 For Australia, where there are capacitors across the insulation under test, it is recommended that d.c. test voltages are used.<br>NOTE 202 The 3 kV and 1.5 kV values for Australia have been determined considering the low frequency induced voltages from the power supply distribution system.  |                 | N/A     |
| <b>6</b>                 | <b>Electrically-caused fire</b>   |                 | P       |
| <b>6.1</b>               | <b>General</b><br>After the first paragraph, <i>insert</i> the following new paragraph:<br>Alternatively, the requirements of Clauses 6.2 to 6.5.2 are considered to be fulfilled if the equipment complies with the requirements of Clause 6.202   |                 | P       |
| <b>6.6</b>               | After Clause 6.6, <i>add</i> the new Clauses 6.201 and 6.202 as follows:<br><b>6.201 External power supplies, docking stations and other similar devices</b><br>and<br><b>6.202 Resistance to fire—Alternative tests</b><br>(see special national conditions)   |                 | P       |
| <b>8.5.4</b>             | <b>Special categories of equipment comprising moving parts</b>  |                 | N/A     |
| <b>8.5.4.1</b>           | <b>Large data storage equipment</b><br>In the first dashed row and the second dashed rows <i>replace</i> 'IEC 60950-1:2005' with 'AS/NZS 60950.1:2015'.   |                 | N/A     |
| <b>8.6</b>               | <b>Stability of equipment</b>   |                 | N/A     |

| IEC62368_1B - ATTACHMENT         |  |                 |         |
|----------------------------------|--|-----------------|---------|
| Clause                           | Requirement + Test   | Result - Remark | Verdict |
| <b>8.6.1 and Table 36</b>        | <p><b>Requirements</b></p> <p>1. Table 36, <i>insert</i> Footnote c at the end of the 'Glass slide' heading, and <i>add</i> a new Footnote c after the text of Footnote b in the last row of Table 36 as follows:</p> <p>° The glass slide test is not applicable to floor standing equipment, even though the equipment may have controls or a display.</p> <p>2. Table 36, fifth row, <i>insert</i> <sup>201</sup> at the end of 'No stability requirements'</p> <p>3. Table 36, ninth row, <i>insert</i> <sup>201</sup> at the end of 'No stability requirements'</p> <p>4. Table 36, <i>add</i> the following new footnote:</p> <p><sup>201</sup> MS2 and MS3 television sets and display devices, designed only for fixing to a wall, ceiling or equipment rack, are not subjected to stability requirements only if the instructional safeguard of Clause 8.6.1.201 is provided. Otherwise, the glass slide requirements of Clause 8.6.4 and horizontal force requirements of Clause 8.6.5 apply.</p> <p>5. Second paragraph beneath Table 36, <i>delete</i> the words 'MS2 and MS3 television sets' and <i>replace</i> with 'MS2 and MS3 television sets and display devices'</p> |                 | N/A     |
| <b>8.6.1</b>                     | <p>After Clause 8.6.1 <i>add</i> the following new clauses:</p> <p><b>8.6.1.201 Instructional safeguard for fixed-mount television sets</b></p> <p>(see special national conditions)</p>   |                 | N/A     |
| <b>Annex F Paragraph F.3.5.1</b> | <p><b>Mains appliance outlet and socket-outlet markings</b></p> <p><i>Replace</i> 'IEC 60320-2-2' with 'AS/NZS 60320.2.2'.</p>   |                 | N/A     |
| <b>Annex G Paragraph G.4.2</b>   | <p><b>Mains connectors</b></p> <p>1 In the second line <i>insert</i> 'or AS/NZS 3123' after 'IEC 60906-1'.</p> <p>2 In the second line <i>insert</i> 'or AS/NZS 60320 series' after 'IEC 60320 series'</p> <p>3 <i>Add</i> the following new paragraph:</p> <p>10 A or 15 A 250 V flat pin plugs for the connection of equipment to mains-powered socket-outlets for household or similar general use shall comply with AS/NZS 3112 or AS/NZS 60884.1.</p>   |                 | N/A     |

| IEC62368_1B - ATTACHMENT       |   |                 |         |
|--------------------------------|---|-----------------|---------|
| Clause                         | Requirement + Test  | Result - Remark | Verdict |
| <b>Paragraph G.5.3.1</b>       | <p><b>Transformers, General</b></p> <p>1 In the third dashed point <i>replace</i> 'IEC 61558-1 and the relevant parts of IEC 61558-2' with 'AS/NZS 61558-1 and the relevant parts of AS/NZS 61558.2'</p> <p>2 In the fourth dashed point <i>replace</i> 'IEC 61558-2-16' with 'AS/NZS 61558.2.16'.</p>  |                 | N/A     |
| <b>Paragraph G.7.1</b>         | <p><b>Mains supply cords, General</b></p> <p>In the fourth dashed paragraph, <i>replace</i> 'IEC 60320-1' with 'AS/NZS 60320.1'</p>   |                 | N/A     |
| <b>Table G.5</b>               | <p><b>Sizes of conductors</b></p> <p>1 In the second row, first column, <i>delete</i> '6' and <i>replace</i> with '7.5'</p> <p>2 In the second row, second column, <i>delete</i> '0,75' and <i>replace</i> with '0.75<sup>b</sup>'</p> <p>3 <i>Delete</i> Note 1.</p> <p>4 <i>Replace</i> 'NOTE 2' with 'NOTE:'.</p> <p>5 <i>Delete</i> the text of 'Footnote b' and <i>replace</i> with the following:</p> <p><sup>b</sup> This nominal cross-sectional area is only allowed for Class II appliances if the length of the power supply cord, measured between the point where the cord, or cord guard, enters the appliance, and the entry to the plug does not exceed 2 m (0.5 mm<sup>2</sup> three-core supply flexible cords are not permitted; see AS/NZS 3191).</p> <p>6 In Footnote c <i>replace</i> 'IEC 60320-1' with 'AS/NZS 60320.1'</p> <p>7 In Footnote d <i>replace</i> 'IEC 60320-1' with 'AS/NZS 60320.1'</p> |                 | N/A     |
| <b>Annex M Paragraph M.3.2</b> | <p><b>Protection circuits for batteries provided within the equipment, Test method</b></p> <p>After the first dashed point <i>add</i> the following Note:</p> <p>NOTE 201: In cases where the voltage source is provided by power from an unassociated power source, consideration should be given to the effects of possible single fault conditions in the unassociated equipment. If the power source is unknown then it should be assumed that the maximum limit of SELV may be applied to the source input under assumed single fault conditions in the source when assessing the charging circuit in the equipment under test.</p>  |                 | N/A     |

| IEC62368_1B - ATTACHMENT |  |  |         |
|--------------------------|--|--|---------|
| Clause                   | Requirement + Test   | Result - Remark  | Verdict |
|                          | <b>Special national conditions (if any)</b>  |  | N/A     |
| <b>6.201</b>             | <p><b>External power supplies, docking stations and other similar devices</b></p> <p>For external power supplies, docking stations and other similar devices, during and after abnormal operating conditions and during single fault conditions the output voltage—</p> <ul style="list-style-type: none"> <li>– at all ES1 outlets or connectors shall not increase by more than 10% of its rated output voltage under normal operating condition; and</li> <li>– of a USB outlet or connector shall not increase by more than 3 V or 10% of its rated output voltage under normal operating conditions, whichever is higher.</li> </ul> <p>For equipment with multiple rated output voltages, the requirements apply with the equipment configured for each rated output voltage in turn.</p> <p>NOTE: This is intended to reduce the possibility of battery fire or explosion in attached equipment or accessories when charging secondary lithium batteries.</p> <p><i>Compliance shall be checked by measurement, taking into account the abnormal operating conditions of Annex B.3 and the simulated single-fault conditions of Annex B.4</i></p> | Max. test result is 24.22V at normal, abnormal, single fault conditions. | P       |
| <b>6.202</b>             | <b>Resistance to fire—Alternative tests</b>  | UL recognized material   | P       |
| <b>6.202.1</b>           | <p><b>General</b></p> <p>Parts of non-metallic material shall be resistant to ignition and spread of fire.</p> <p>This requirement does not apply to decorative trims, knobs and other parts unlikely to be ignited or to propagate flames from inside the equipment, or the following:</p> <ul style="list-style-type: none"> <li>a) Components that are contained in an enclosure having a flammability category of V-0 according to AS/NZS 60695.11.10 and having openings only for the connecting wires filling the openings completely, and for ventilation not exceeding 1 mm in width regardless of length.</li> <li>b) The following parts which would contribute negligible fuel to a fire:</li> </ul>  |  | N/A     |



| IEC62368_1B - ATTACHMENT |   |                 |         |
|--------------------------|---|-----------------|---------|
| Clause                   | Requirement + Test  | Result - Remark | Verdict |
|                          | <p>– small mechanical parts, the mass of which does not exceed 4 g, such as mounting parts, gears, cams, belts and bearings;</p> <p>– small electrical components, such as capacitors with a volume not exceeding 1 750 mm<sup>3</sup>, integrated circuits, transistors and optocoupler packages, if these components are mounted on material of flammability category V-1, or better, according to AS/NZS 60695.11.10.</p> <p>NOTE: In considering how to minimize propagation of fire and what 'small parts' are, account should be taken of the cumulative effect of small parts adjacent to each other for the possible effect of propagating the fire from one part to another.</p> |                 |         |
|                          | <p><i>Compliance shall be checked by the tests of Clauses 6.202.2, 6.202.3 and 6.202.4.</i></p> <p>For the base material of printed boards, compliance shall be checked by the test of Clause 6.202.5.</p> <p>The tests shall be carried out on parts of non-metallic material which have been removed from the equipment. When the glow-wire test is carried out, the parts shall be placed in the same orientation as they would be in normal use.</p> <p>These tests are not carried out on internal wiring.</p>   |                 | N/A     |
| <b>6.202.2</b>           | <p><b>Testing of non-metallic materials</b></p> <p>Parts of non-metallic material shall be subject to the glow-wire test of AS/NZS 60695.2.11 which shall be carried out at 550°C.</p> <p>Parts for which the glow-wire test cannot be carried out, such as those made of soft or foamy material, shall meet the requirements specified in ISO 9772 for category FH-3 material. The glow-wire test shall be not carried out on parts of material classified at least FH-3 according to ISO 9772 provided that the relevant part is not thinner than the sample tested.</p>  |                 | N/A     |
| <b>6.202.3</b>           | <p><b>Testing of insulating materials</b></p> <p>Parts of insulating material supporting Potential Ignition Sources shall be subject to the glow-wire test of AS/NZS 60695.2.11 which shall be carried out at 750°C.</p> <p>The test shall be also carried out on other parts of insulating material which are within a distance of 3 mm of the connection.</p> <p>NOTE: Contacts in components such as switch contacts are considered to be connections</p>  |                 | N/A     |

| IEC62368_1B - ATTACHMENT               |  |                             |         |                         |  |  |  |                                     |  |  |     |
|--|--|-----------------------------|---------|-------------------------|--|--|--|-------------------------------------|--|--|-----|
| Clause                                 | Requirement + Test   | Result - Remark             | Verdict |                         |  |  |  |                                     |  |  |     |
|  | <p>For parts which withstand the glow-wire test but produce a flame, other parts above the connection within the envelope of a vertical cylinder having a diameter of 20 mm and a height of 50 mm shall be subjected to the needle-flame test.</p> <p>However, parts shielded by a barrier which meets the needle-flame test need not be tested</p>  |                             | N/A     |                         |  |  |  |                                     |  |  |     |
|  | <p>The needle-flame test shall be made in accordance with AS/NZS 60695.11.5 with the following modifications:</p> <table border="1"> <thead> <tr> <th>Clause of AS/NZS 60695.11.5</th> <th>Change</th> </tr> </thead> <tbody> <tr> <td><b>9 Test procedure</b></td> <td></td> </tr> <tr> <td><b>9.2 Application of needle-flame</b></td> <td> <p><i>Delete</i> the first and second paragraphs and <i>replace</i> with the following:</p> <p>The specimen shall be arranged so that the flame can be applied to a vertical or horizontal edge as shown in the examples of Figure 1. If possible the flame shall be applied at least 10 mm from a corner.</p> <p>The duration of application of the test flame shall be 30 s ± 1 s.</p> </td> </tr> <tr> <td><b>9.3 Number of test specimens</b></td> <td> <p><i>Replace</i> with the following:</p> <p>The test shall be made on one specimen. If the specimen does not withstand the test, the test may be repeated on two further specimens, both of which shall withstand the test.</p> </td> </tr> </tbody> </table> | Clause of AS/NZS 60695.11.5 | Change  | <b>9 Test procedure</b> |  | <b>9.2 Application of needle-flame</b> | <p><i>Delete</i> the first and second paragraphs and <i>replace</i> with the following:</p> <p>The specimen shall be arranged so that the flame can be applied to a vertical or horizontal edge as shown in the examples of Figure 1. If possible the flame shall be applied at least 10 mm from a corner.</p> <p>The duration of application of the test flame shall be 30 s ± 1 s.</p> | <b>9.3 Number of test specimens</b> | <p><i>Replace</i> with the following:</p> <p>The test shall be made on one specimen. If the specimen does not withstand the test, the test may be repeated on two further specimens, both of which shall withstand the test.</p> |  | N/A |
| Clause of AS/NZS 60695.11.5            | Change   |                             |         |                         |  |  |  |                                     |  |  |     |
| <b>9 Test procedure</b>                |  |                             |         |                         |  |  |  |                                     |  |  |     |
| <b>9.2 Application of needle-flame</b> | <p><i>Delete</i> the first and second paragraphs and <i>replace</i> with the following:</p> <p>The specimen shall be arranged so that the flame can be applied to a vertical or horizontal edge as shown in the examples of Figure 1. If possible the flame shall be applied at least 10 mm from a corner.</p> <p>The duration of application of the test flame shall be 30 s ± 1 s.</p>   |                             |         |                         |  |  |  |                                     |  |  |     |
| <b>9.3 Number of test specimens</b>    | <p><i>Replace</i> with the following:</p> <p>The test shall be made on one specimen. If the specimen does not withstand the test, the test may be repeated on two further specimens, both of which shall withstand the test.</p>   |                             |         |                         |  |  |  |                                     |  |  |     |

| IEC62368_1B - ATTACHMENT |  |  |         |
|--------------------------|--|--|---------|
| Clause                   | Requirement + Test   |  | Verdict |
|                          | <p><b>11 Evaluation of test results</b></p>  | <p><i>Replace</i> with the following:<br/>The duration of burning (tb) shall not exceed 30 s.<br/>However,<br/>for printed circuit boards, it shall not exceed 15 s.</p> |         |
|                          | <p>The needle-flame test shall not be carried out on parts of material classified as V-0 or V-1 according to AS/NZS 60695.11.10, provided that the relevant part is not thinner than the sample tested.</p>  |  |         |
| 6.202.4                  | <p><b>Testing in the event of non-extinguishing material</b></p> <p>If parts, other than enclosures, do not withstand the glow wire tests of Clause 6.202.3, by failure to extinguish within 30 s after the removal of the glowwire tip, the needle-flame test detailed in Clause 6.202.3 shall be made on all parts of non-metallic material which are within a distance of 50 mm or which are likely to be impinged upon by flame during the tests of Clause 6.202.3. Parts shielded by a separate barrier which meets the needle-flame test need not be tested.</p> <p>NOTE 1: If the enclosure does not withstand the glow-wire test the equipment is considered to have failed to meet the requirements of Clause 6.202 without the need for consequential testing.</p> <p>NOTE 2: If other parts do not withstand the glow-wire test due to ignition of the tissue paper and if this indicates that burning or glowing particles can fall onto an external surface underneath the equipment, the equipment is considered to have failed to meet the requirements of Clause 6.202 without the need for consequential testing.</p> <p>NOTE 3: Parts likely to be impinged upon by the flame are considered to be those within the envelope of a vertical cylinder having a radius of 10 mm and a height equal to the height of the flame, positioned above the point of the material supporting, in contact with, or in close proximity to, connections.</p> |  | N/A     |

| IEC62368_1B - ATTACHMENT |   |                 |         |
|--------------------------|---|-----------------|---------|
| Clause                   | Requirement + Test  | Result - Remark | Verdict |
| 6.202.5                  | <p><b>Testing of printed boards</b></p> <p>The base material of printed boards shall be subjected to the needle-flame test of Clause 6.202.3. The flame shall be applied to the edge of the board where the heat sink effect is lowest when the board is positioned as in normal use. The flame shall not be applied to an edge, consisting of broken perforations, unless the edge is less than 3 mm from a potential ignition source.</p> <p>The test is not carried out if—</p> <ul style="list-style-type: none"> <li>– the printed board does not carry any potential ignition source;</li> <li>– the base material of printed boards, on which the available apparent power at a connection exceeds 15 VA operating at a voltage exceeding 50 V and equal or less than 400 V (peak) a.c. or d.c. under normal operating conditions, is of flammability category V-1 or better according to AS/NZS 60695.11.10, or the printed boards are protected by an enclosure meeting the flammability category V-0 according to AS/NZS 60695.11.10, or made of metal, having openings only for connecting wires which fill the openings completely; or</li> <li>– the base material of printed boards, on which the available equipment power at a connection exceeds 15 VA operating at a voltage exceeding 400 V (peak) a.c. or d.c. under normal operating conditions, and base material of printed boards supporting spark gaps which provides protection against overvoltages, is of flammability category V-0 according to AS/NZS 60695.11.10 or the printed boards are contained in a metal enclosure, having openings only for connecting wires which fill the openings completely.</li> </ul> <p><i>Conformance shall be determined using the smallest thickness of the material.</i></p> <p>NOTE: Available apparent power is the maximum apparent power which can be drawn from the supplying circuit through a resistive load whose value is chosen to maximize the apparent power for more than 2 min when the circuit supplied is disconnected.</p> |                 | N/A     |

| IEC62368_1B - ATTACHMENT |   |                 |         |
|--------------------------|---|-----------------|---------|
| Clause                   | Requirement + Test  | Result - Remark | Verdict |
| 6.202.6                  | <p><b>For open circuit voltages greater than 4 kV</b></p> <p>Potential ignition sources with open circuit voltages exceeding 4 kV (peak) a.c. or d.c. under normal operating conditions shall be contained in a FIRE ENCLOSURE which shall comply with flammability category V-1 or better according to AS/NZS 60695.11.10.</p>   |                 | N/A     |
| 8.6.1.201                | <p><b>8.6.1.201 Instructional safeguard for fixed-mount television sets</b></p> <p>MS2 and MS3 television sets and display devices designed only for fixed mounting to a wall of ceiling or equipment rack shall, where required in Table 36, footnote 201, have an instructional safeguard in accordance with Clause F.5 which may be on the equipment or included in the installation instructions or equivalent document accompanying the equipment.</p> <p>The elements of the instructional safeguard shall be as follows:</p> <ul style="list-style-type: none"> <li>– element 1a: not available;</li> <li>– element 2: 'Stability Hazard' or equivalent wording;</li> <li>– element 3: 'The television set may fall, causing serious personal injury or death' or equivalent text;</li> <li>– element 4: the following or equivalent text:</li> </ul> <p>To prevent injury, this television set must be securely attached to the floor/wall in accordance with the installation instructions</p> |                 | N/A     |
| 8.6.1.202                | <p><b>Restraining device</b></p> <p>MS2 and MS3 television sets and display devices that are not solely fixed-mounted should be provided with a restraining device such as a fixing point to facilitate restraining the equipment from toppling forward. The restraining device shall be capable of withstanding a pull of 100 N in all directions without damage.</p> <p>Where a restraining device is provided, instructions shall be provided in the instructions for installation or instructions for use to ensure correct and safe installation.</p>  |                 | N/A     |



| IEC62368_1B - ATTACHMENT |                    |                 |         |
|--------------------------|--------------------|-----------------|---------|
| Clause                   | Requirement + Test | Result - Remark | Verdict |

| <b>ATTACHMENT TO TEST REPORT</b><br><b>IEC 62368-1</b><br><b>(JAPAN) NATIONAL DIFFERENCES</b><br>(Audio/video, information and communication technology equipment – Part 1: Safety requirements) |  |          |     |
|--|--|----------|-----|
| <b>Differences according to</b> .....: J62368-1 (2020)   |  |          |     |
| <b>TRF template used:</b> .....: IECEE OD-2020-F3, Ed. 1.1   |  |          |     |
| <b>Attachment Form No.</b> .....: JP_ND_IEC62368_1B  |  |          |     |
| <b>Attachment Originator</b> .....: UL (JP)  |  |          |     |
| <b>Master Attachment</b> .....: Date 2020-11-06  |  |          |     |
| <b>Copyright © 2020 IEC System for Conformity Testing and Certification of Electrical Equipment (IECEE), Geneva, Switzerland. All rights reserved.</b>   |  |          |     |
|  | <b>National Differences</b>  |          | P   |
| 4.1.2  | Where the component, or a characteristic of a component, is a safeguard or a part of a safeguard, components shall comply with the requirements of this standard or, where specified in a requirements clause, with the safety aspects of the relevant JIS component standards or IEC component standards, or components shall have properties equivalent to or better than these. |          | P   |
| 5.6.1  | Mains socket-outlet and appliance outlet shall comply with Clause G.4.2A if they are incorporated as part of the equipment.  |          | N/A |
| 5.6.2.1  | Mains connection of class 0I equipment:<br>Instructional safeguard in accordance with Clause F.3.6.1A;<br><br>Mains plug having a lead wire for protective earthing connection of class 0I equipment;<br><br>Independent main protective earthing terminal installed by ordinary person.   | Class II | N/A |

| IEC62368_1B - ATTACHMENT |   |                 |         |
|--------------------------|---|-----------------|---------|
| Clause                   | Requirement + Test  | Result - Remark | Verdict |
| 5.6.2.2                  | This requirement does not apply to internal conductor of the cord set that is covered by the sheath of mains cord and is formed together with mains plug and appliance connector.   |                 | N/A     |
| 5.6.3                    | In case of class 0I equipment using power supply cord having two conductors (no earthing conductor), the conductor of protective earthing lead wire shall comply with either of the following:<br><br>– use of annealed copper wire with 1.6 mm diameter or corrosion-inhibiting metal wire having size and strength that are equivalent to or more than the above copper wire<br><br>– single core cord or single core cab tire cable with 1.25 mm <sup>2</sup> or more cross-sectional area |                 | N/A     |
| 5.7.3                    | For class 0I equipment that is provided with mains socket-outlet in the configuration as specified in JIS C 8282 series or JIS C 8303, or otherwise being considered to comply with relevant regulations, or that is provided with mains appliance outlet as specified in JIS C 8283-2-2 for the purpose of interconnection, the measurement is conducted on the system of the interconnected equipment having a single connection to the mains.  |                 | N/A     |
| 5.7.4                    | In case of class 0I equipment, touch current shall not exceed 1.41 mA peak or for sinusoidal wave, 1.0 mA r.m.s. when measured using the network specified in Figure 4 of IEC 60990.  |                 | N/A     |

| IEC62368_1B - ATTACHMENT |   |                     |         |
|--------------------------|---|---------------------|---------|
| Clause                   | Requirement + Test  | Result - Remark     | Verdict |
| 6.4.3.3                  | <p>A fuse complying with JIS C 6575 series or a fuse having equivalent characteristics shall open within 1 s.</p> <p>For Class A fuse of JIS C 6575, replace “2.1 times” by “1.35 times” and in case of Class B fuse of JIS C 6575, replace “2.1 times” by “1.6 times”.</p> <p>A fuse not complying with JIS C 6575 series shall be tested with the breaking capacity taken into account.</p> | Test with appliance | P       |
| 8.5.4.2.1                | Only three-phase stationary equipment rated more than 200 V ac can be considered as being for use in locations where children are not likely to be present, when complying with Clause F.4.   |                     | N/A     |
| 8.5.4.2.2                | For equipment installed where children may be present, an instructional safeguard shall be provided by easily understandable wording in accordance with Clause F.5, except that element 3 is optional.  |                     | P       |
| 8.5.4.2.4                | The media destruction device is tested according to Clause V.1.2 with applicable jointed test probes to the opening. And then the wedge probe per Figure V.4 shall not contact any moving part.   |                     | P       |
| 8.5.4.2.5                | <p>The wedge probe of Figure V.4 and applicable jointed test probes specified in Clause V.1.2 shall not contact any moving part.</p> <p>Instructional safeguard shall not be used instead of equipment safeguard for preventing access to hazardous moving parts.</p>   |                     | P       |
| 9.2.6,<br>Table 38       | Handles, Knobs, grips, etc. and external surfaces either held, touched or worn against the body in normal use (> 1 min) <sup>b,c</sup>  |                     | N/A     |



| IEC62368_1B - ATTACHMENT |  |                   |         |
|--------------------------|--|-------------------|---------|
| Clause                   | Requirement + Test   | Result - Remark   | Verdict |
| F.3.5.1                  | Instructional safeguard of class 0I equipment in accordance with Clause F.5 when a mains socket-outlet as specified in JIS C 8282 series, JIS C 8303 or relevant regulation to which class I equipment can be connected is provided in accordance with Clause G.4.2A except for the cases where the socket-outlet is accessible only to skilled persons.   | Class II, Inlet   | N/A     |
| F.3.5.3                  | If the fuse is necessary for the safeguard function, the symbols indicating pre-arcing time-current characteristic.  |                   | N/A     |
| F.3.6.1A                 | Marking for class 0I equipment<br><br>The requirements of Clauses F.3.6.1.1 and F.3.6.1.3 shall be applied to class 0I equipment.<br><br>For class 0I equipment, a marking of instructions and instructional safeguard shall be provided regarding the earthing connection.  |                   | N/A     |
| F.3.6.2.1                | Symbols, IEC 60417-5172 (2003-02) or IEC 60417-6092 (2011-10), shall not be used for class I equipment or class 0I equipment.  |                   | P       |
| F.4                      | Instruction for audio equipment with terminals classified as ES3 in accordance with Table E.1, and for other equipment with terminals marked in accordance with F.3.6.1 and F.3.6.1A.<br><br>Installation instruction for the protective earthing connection for class 0I equipment provided with independent main protective earthing terminal, where the cord for the protective earthing connection is not provided within the package for the equipment. |                   | N/A     |
| G.3.2.1                  | The thermal link when tested as a separate component, shall comply with the requirements of JIS C 6691 or have properties equivalent to or better than that.   | No such component | N/A     |

| IEC62368_1B - ATTACHMENT |   |                 |         |
|--------------------------|---|-----------------|---------|
| Clause                   | Requirement + Test  | Result - Remark | Verdict |
| G.3.4                    | <p>Except for devices covered by Clause G.3.5, overcurrent protective devices used as a safeguard shall comply with the relevant part of JIS C 6575 (corresponding to IEC60127) or shall have equivalent characteristics.</p> <p>If there are no applicable IEC standards, overcurrent protective devices used as a safeguard shall comply with their applicable IEC standards.</p>   |                 | P       |
| G.4.1                    | This requirement is not applicable to Clauses G.4.2 and G.4.2A.   |                 | N/A     |
| G.4.2                    | <p>Mains connector shall comply with JIS C 8282 series, JIS C 8283 series, JIS C 8285, JIS C 8303 or IEC 60309 series.</p> <p>Mains plugs and socket-outlets shall comply with JIS C 8282 series, JIS C 8303, IEC 60309 series, or have equivalent or better performance.</p> <p>A power supply cord set provided with appliance connector that can fit appliance inlet complying with JIS C 8283-1 shall comply with JIS C 8286.</p> <p>Construction preventing mechanical stress not to transmit to the soldering part of inlet terminal. Consideration for an equipment rated not more than 125 V provided with Type C14 and C18 appliance coupler complying with JIS C 8283 series.</p> |                 | N/A     |
| G.4.2A                   | Mains socket-outlet and interconnection coupler provided with the class II, class I and class 0I equipment respectively.  |                 | N/A     |
| G.7.1                    | A mains supply cord need not include the protective earthing conductor for class 0I equipment provided with independent protective earthing conductor.  |                 | N/A     |
| G.8.3.3                  | Withstand $1,71 \times 1.1 \times U_0$ for 5 s.   |                 | N/A     |



| IEC62368_1B - ATTACHMENT |                    |                 |         |
|--------------------------|--------------------|-----------------|---------|
| Clause                   | Requirement + Test | Result - Remark | Verdict |

| <b>ATTACHMENT TO TEST REPORT</b><br><b>IEC 62368-1</b><br><b>ITALY NATIONAL DIFFERENCES</b><br>(Audio/video, information and communication technology equipment – Part 1: Safety requirements) |  |                    |     |
|--|--|--------------------|-----|
| <b>Differences according to</b> .....: CEI EN 62368-1:2016   |  |                    |     |
| <b>Attachment Form No.</b> .....: IT_ND_IEC62368_1B  |  |                    |     |
| <b>Attachment Originator</b> .....: IMQ S.p.A.   |  |                    |     |
| <b>Master Attachment</b> .....: Date 2020-01-31  |  |                    |     |
| <b>Copyright © 2020 IEC System for Conformity Testing and Certification of Electrical Equipment (IECEE), Geneva, Switzerland. All rights reserved.</b>   |  |                    |     |
|  | <b>National Differences</b>  |                    | P   |
| F.1  | <p><b>Italy</b></p> <p>The following requirements shall be fulfilled:</p> <ul style="list-style-type: none"> <li>• The power consumption in Watts (W) shall be indicated on TV receivers and in their instruction for use (Measurement according to EN 60555-2).</li> </ul> <p>Note: <i>EN 60555-2 has since been replaced by IEC 60107-1:1997.</i></p> <ul style="list-style-type: none"> <li>• TV receivers shall be provided with an instruction for use, schematic diagrams and adjustments procedure in Italian language.</li> <li>• Marking for controls and terminals shall be in Italian language. Abbreviation and international symbols are allowed provided that they are explained in the instruction for use.</li> <li>• The ECC manufacturers are bound to issue a conformity declaration according to the above requirements in the instruction manual. The correct statement for conformity to be written in the instruction manual, shall be:<br/><i>Questo apparecchio è fabbricato nella CEE nel rispetto delle disposizioni del D.M. marzo 1992 ed è in particolare conforme alle prescrizioni dell'art. 1 dello stesso D.M.</i></li> <li>• The first importers of TV receivers manufactured outside EEC are bound to submit the TV receivers for previous conformity certification to the Italian Post Ministry (PP.TT). The TV receivers shall have on the backcover the certification number in the following form:<br/>D.M. 26/03/1992 xxxxx/xxxxx/S or T or pT</li> </ul> | No such equipment. | N/A |



| IEC62368_1B - ATTACHMENT |   |                    |         |
|--------------------------|---|--------------------|---------|
| Clause                   | Requirement + Test  | Result - Remark    | Verdict |
|                          | S for stereo<br>T for Teletext<br>pT for retrofitable teletext  |                    |         |
|                          | <i>Justification:</i><br>Ministerial Decree of 26 March 1992 : National rules for television receivers trade.<br><br><i>NOTE/: Ministerial decree above contains additional, but not safety relevant requirements</i> | No such equipment. | N/A     |

-END-

| National Special Requirement to IEC 62368-1 |                    |                 |         |
|---|--------------------|-----------------|---------|
| Clause                                      | Requirement + Test | Result - Remark | Verdict |

|  |
|--|
| <p><b>ATTACHMENT TO TEST REPORT IEC 62368-1</b><br/> <b>Canada National Differences</b><br/> Information technology equipment – Safety –<br/> Part 1: General requirements</p> |
| <p><b>Differences according to.....: CAN/CSA C22.2 No. 62368-1-14</b></p>  |

|         |  |                     |     |
|---------|--|---------------------|-----|
| 1DV.1   | <i>Battery backup systems that are not an integral part of stationary equipment, such as provided in separate cabinets, are subject to the appropriate standard for battery backup systems, such as UL 1973, Batteries for Use in Light Electric Rail (LER) Applications and Stationary Applications</i>                 | Not such equipment. | N/A |
| 1DV.2   | <i>For equipment intended for outdoor installation, additional requirements for Information and communication technology equipment are covered by CSA/UL 60950-22 and for Audio/video equipment are covered by the relevant requirements in CSA C22.2 No. 60065 or UL 60065.</i>   | Not for outdoor     | N/A |
| 1DV.3.1 | <i>Standard is applicable to equipment signed to be installed in accordance with the Canadian Electrical Code, Part I, C22.1-12; Canadian Electrical Code, Part II, General Requirements, CAN/CSA C22.2 No. 0-10; the National Electrical Code, NFPA 70-2014; and the National Electrical Safety Code, IEEE C2-2012.</i> |                     | N/A |
| 1DV.3.2 | <i>For equipment signed to be installed in accordance with Article 645 of the National Electrical Code, NFPA 70- 2014, and the Standard for the Protection of Information Technology Equipment, NFPA 75-2013, identification by a marking or instruction [see Annex DVK (Annex DVA, Clause 1)] is required.</i>          |                     | N/A |
| 1DV.3.3 | <i>Additional regulatory requirements that apply to this equipment per Annex DVA, as applicable.</i>   |                     | N/A |
| 1DV.4.1 | <i>Additional requirements for equipment used for entertainment purposes intended for installation in general patient care areas of health care facilities per Annex DVB.</i>  |                     | N/A |
| 1DV.4.2 | <i>This standard includes additional requirements for equipment intended for mounting under kitchen cabinets. See Annex DVC.</i>   |                     | N/A |
| 1DV.4.3 | <i>This standard does not apply to equipment having Remote Feeding Telecommunication (RFT) circuits. Equipment having RFT circuits is covered by CSA 60950-21.</i>   |                     | N/A |

| National Special Requirement to IEC 62368-1 |  |                 |         |
|---|--|-----------------|---------|
| Clause                                      | Requirement + Test   | Result - Remark | Verdict |
| 1DV.4.4                                     | <i>Additional requirements may apply to large data storage equipment. Refer to CSA 60950-23.</i>   |                 | N/A     |
| 1DV.4.5                                     | <i>Does not cover Modular Data Centres (MDCs) but only the information and communication technology equipment contained within.</i>  |                 | N/A     |
| 1DV.5.1                                     | <i>Power Distribution Equipment and Sub-Assemblies</i>   |                 | N/A     |
| 1DV.5.1.1                                   | <i>Power distribution sub-assemblies connected to a mains used to distribute power entirely within a system of equipment, such as power distribution units (PDUs), cord-connected power strips, shelves with multiple power outlets (receptacles) etc., and intended to be installed in system racks, cabinets, home entertainment centres, etc. are covered by this standard</i>  |                 | N/A     |
| 1DV.5.1.2                                   | <i>For equipment covered by this standard that incorporates components and sub-assemblies that perform a power distribution and control function covered by other standards, such as panel boards, load transfer equipment, or uninterruptible power systems utilized in power conditioners and computer power centres, this standard only may be used for investigation of safety for those aspects not covered by the other standards.</i> |                 | N/A     |
| 1DV.5.1.3                                   | <i>This standard also does not apply to stand-alone equipment used for distribution of mains power that is covered by individual power distribution equipment standards.</i>   |                 | N/A     |
| 1DV.5.1.4                                   | <i>Based on the specific function, the following requirements are applicable to the stand-alone distribution equipment, or apply additionally to power distribution sub-assemblies and components of equipment covered by this standard, ascribed in 1DV.5.1.2 and 1DV.5.1.3.</i>  |                 | N/A     |
|   | – For Industrial Control Equipment, see CSA C22.2 No. 14 and UL 508.   |                 | N/A     |
|   | – For Panelboards, see CSA C22.2 No. 29 and UL 67.   |                 | N/A     |
|   | – For Switchboards, see CSA C22.2 No 244 and UL 891.   |                 | N/A     |
|   | – For Transfer Switch Equipment, see CSA C22.2 No 178.1 and UL 1008.   |                 | N/A     |
|   | – For Uninterruptible Power Systems, see CSA C22.2 No. 107.3 and UL 1778.  |                 | N/A     |
|   | – For Power Distribution Centers for Communications Equipment, see UL Subject 1801.  |                 | N/A     |

| National Special Requirement to IEC 62368-1 |   |                 |         |
|---|---|-----------------|---------|
| Clause                                      | Requirement + Test  | Result - Remark | Verdict |
|   | <p>– Other forms of power distribution units for general applications, such as,</p> <ul style="list-style-type: none"> <li>• Relocatable Power Taps, CSA-C22.2 No. 21, Cord Sets and Power Supply Cords, and UL 1363, Relocatable Power Taps.</li> <li>• Cord connected Surge Protective Devices, CSA Technical Information Letter No. A-24, Interim Certification Requirements for AC Line Connected Wiring Devices with Varistors, and UL 1449, Surge Protective Devices.</li> <li>• Furniture Power Distribution Units, CSA-C22.2 No. 21, Cord Sets and Power Supply Cords and UL 962A, Furniture Power Distribution Units.</li> </ul> |                 | N/A     |
| 3.3.1.2DV                                   | <i>For additional information regarding low voltage d.c. mains (centralized d.c. power systems) equipment, refer to Annex DVD. This standard covers high voltage d.c. mains up to 600 Vdc.</i>  |                 | N/A     |
| 3.3.1.3DV.1                                 | <p><i>New definition: telecommunication network – metallicly terminated transmission medium intended for communication between equipment that may be located in separate buildings, excluding:</i></p> <ul style="list-style-type: none"> <li>- <i>The mains system for supply, transmission and distribution of electrical power, if used as a telecommunication transmission medium;</i></li> <li>- <i>Cable distribution systems;</i></li> <li>- <i>ES1 circuits connecting units of audio/video, information and communication technology equipment.</i></li> </ul>   |                 | N/A     |
| 4.1.1DV.1.D2                                | In the U.S. and Canada, components and subassemblies that comply with the standards referenced in Annex DVE are required in addition to or as a replacement for the requirements in this standard. Components complying with these standards are considered acceptable as part of equipment covered by this standard without further evaluation other than to give consideration to the appropriate use of the component or subassembly in the end product.   |                 | P       |

| National Special Requirement to IEC 62368-1    |  |                 |         |
|--|--|-----------------|---------|
| Clause   | Requirement + Test   | Result - Remark | Verdict |
| 4.1.1DV.2.<br>DC                               | In the U.S. and Canada, components and subassemblies that comply with the standards referenced in Annex DVG are acceptable as an alternative to requirements as part of equipment covered by this standard without further evaluation other than to give consideration to the appropriate use of the component or subassembly in the end product.  |                 | P       |
| 4.1.2DV.D<br>C                                 | In the U.S. and Canada, some UL/CSA component standards may be used as alternatives to referenced IEC standards for the purposes of North America certifications or surveillance programs. Components and subassemblies that comply with the standards referenced in Annex DVF are acceptable as part of equipment covered by this standard without further evaluation other than to give consideration to the appropriate use of the component or subassembly in the end product. |                 | P       |
| 4.1.16DV.1                                     | Mains connections  |                 | P       |
| 4.1.16DV.1<br>.1<br>DE,<br>4.1.16DV.1<br>.2 DR | Requirements for Mains Supply Cords for Pluggable (Cord Connected) Equipment (Canadian and U.S. regulatory based requirements) - Annex G.7 and G.7ADV  |                 | N/A     |
| 4.1.16DV.1<br>.3<br>D2,<br>4.1.16DV.1<br>.4 DR | Requirements for Permanently Connected Equipment. (Canadian and U.S. regulatory-based requirements) – Annex DVH  |                 | N/A     |
| 4.1.17DV.1                                     | <i>External interconnecting cable and wiring</i>   |                 | N/A     |
| 4.1.17DV.1<br>.1                               | <i>General</i><br><i>External interconnecting cable and wiring are investigated to the requirements of 6.5 and either 4.1.17DV.1.2 or 4.1.17DV.1.3, as appropriate.</i>  |                 | N/A     |
|  | <i>- External interconnecting cable and wiring 3,05 m or less may be investigated as part of the equipment (system) to the requirements of this standard. See 4.1.17DV.1.2.</i>  |                 | N/A     |
|  | <i>- External interconnect cable and wiring longer than 3,05 m are regulated by the Canadian Electrical Code, C22.1, and the National Electrical Code, NFPA 70, and are subject to associated requirements. See 4.1.17DV.1.3.</i>  |                 | N/A     |



| National Special Requirement to IEC 62368-1 |  |                 |         |
|---|--|-----------------|---------|
| Clause                                      | Requirement + Test   | Result - Remark | Verdict |
|   | <i>External interconnect cable longer than 3,05 m designed to carry audio and/or video signals only, and that is not specified by the manufacturer to be routed inside the building structure (e.g., walls, ceilings, etc.), is subject to the applicable requirements of 4.1.17DV.1.2. For purposes of 4.1.17DV.1.2, it is assumed such cables are connected to PS1 circuits.</i>   |                 | N/A     |
|   | <i>Alternatively, detachable external interconnecting cable and wiring (with terminations) may be excluded from the equipment evaluation if specified by the manufacturer.</i>   |                 | N/A     |
| 4.1.17DV.1.2                                | <p><i>Equipment (system) interconnecting cable and wiring.</i></p> <p><i>The following requirements apply to detachable and nondetachable external interconnecting cable and wiring investigated as part of the equipment (system).</i></p> <ul style="list-style-type: none"> <li>- <i>The length of the external interconnecting cable or wiring shall not exceed 3,05 m;</i></li> <li>- <i>For external interconnecting cable and wiring connected to PS2 and PS3 circuits, see 6.5 for fire (flammability) considerations;</i></li> <li>- <i>There are no fire (flammability) considerations for external interconnecting cable and wiring specified by the manufacturer for connection to circuits that are PS1.</i></li> <li>- <i>External interconnecting cable and wiring intended to be connected to an ES3 or PS3 circuit require a jacket for mechanical protection in accordance with Table G.7ADV.2, or equivalent;</i></li> <li>- <i>Detachable external interconnecting cable and wiring (with terminations) intended to be connected to a PS2, PS3, ES2 or ES3 circuit and furnished as part of the equipment shall be either marked, or similarly identified in the installation instructions with (a) the name, trademark or trade name of the organization that is responsible for the equipment, and (b) the organization's identifying number or equivalent designation for the cable. See Annex DVK.</i> <ul style="list-style-type: none"> <li>o <i>The marking may be applied on the cable and wiring at any location.</i></li> <li>o <i>This marking is not required to comply with the test for permanence of markings, F.3.9</i></li> </ul> </li> </ul> <p><i>Optical fibre interconnecting cables 3,05 m or less are not subject to the above requirements</i></p> |                 | N/A     |

| National Special Requirement to IEC 62368-1 |   |                 |         |
|---|---|-----------------|---------|
| Clause                                      | Requirement + Test  | Result - Remark | Verdict |
| 4.1.17DV.1<br>.3                            | <i>External interconnecting cable and wiring considered part of the building installation.<br/>External interconnecting cables and wiring longer than 3,05 m are regulated by the Canadian Electrical Code, C22.1, and the National Electrical Code, NFPA 70. See Annex DVA (Annex Q entry).</i>  |                 | N/A     |
| 4.6.2DV<br>D2                               | <i>Additional examples of compliance:<br/>- Wire-wrap terminals used for the connection of ES1 and ES2 that are:<br/>o provided on equipment that forms part of the telecommunication network, up to and including the marcation point, and are located in service access areas only. (This equipment is generally considered Central Office Equipment, although it may deployed elsewhere in similarly controlled environments.) and<br/>o provided with a guard or cover that prevents unintentional contact during normal operation. Are tested with a steady force of 2,5 N ± 0,25 N.</i> |                 | N/A     |
| 4.8.3DV<br>D2                               | <i>If screws or similar fasteners are used to secure the door/cover providing access to the battery compartment, the fasteners shall be captive to ensure that they remain with the door/cover. This does not apply to side panel doors on larger vices which are necessary for the functioning of the equipment and which are not likely to be discarded or left off the equipment</i>   |                 | N/A     |
| 4.8.4.5DV<br>D2                             | <i>0,5 J impact test is deleted.</i>  |                 | N/A     |
| 4.8.5DV.1<br>D2                             | <i>Replace 30 N battery compartment door/cover test with 45 N</i>   |                 | N/A     |
| 4.8.5DV.2<br>D2                             | <i>Replace the first and second dashed paragraphs with the following:<br/>- the battery compartment door/cover shall not open; and<br/>- the battery shall not become accessible.</i>   |                 | N/A     |
| 5.4.4.1DV<br>D1                             | <i>For printed boards, see Clause G.13<br/>For antenna terminals, see Clause 5.4.5<br/>For solid insulation on internal and external wiring, see Clause G.6.<br/>Additionally, for internal wiring accessible to an ordinary person, see Clause 5.4.6.</i>  |                 | N/A     |

| National Special Requirement to IEC 62368-1 |   |                 |         |
|---|---|-----------------|---------|
| Clause                                      | Requirement + Test  | Result - Remark | Verdict |
| 5.6.3DV.1 to 5.6.3DV.3                      | <i>Protective earthing conductors shall comply with the minimum conductor sizes in Table G.5, except as required by</i><br>-Table G.7ADV.1 for cord connected equipment; or<br>- Annex DVH for permanently connected equipment.   |                 | N/A     |
| 5.6.4.1DV                                   | <i>Minimum conductor size alternative compliance to Table G.5 or Table G.7ADV.1 as applicable, or Table 31 Minimum protective bonding conductor size of copper conductors</i>   |                 | N/A     |
| 5.6.4.4DV                                   | <i>Protective bonding conductor sizes alternative compliance to Table G.7ADV.1 in addition to Table 31 or Table G.5</i>   |                 | N/A     |
| Table 32 DV                                 | <i>Include alternative conductor size compliance with Table G.7ADV.1 in the first column heading for protective conductor terminals.</i>  |                 | N/A     |
| 5.6.6.1 DV                                  | <i>Protective bonding conductors that meet the minimum conductor sizes in Table G.5 or Table G.7ADV.1 as applicable, throughout their length and whose terminals all meet the minimum sizes in Table 32 are considered to comply without test.</i>                          |                 | N/A     |
| 5.7.6.2DV                                   | <i>Clause title modified to read "Prospective touch voltage and touch current to external circuits"</i>   |                 | N/A     |
| 5.7.7DV.1                                   | <i>Clause 5.7.7 to apply to stationary pluggable equipment type A or pluggable equipment type B</i>   |                 | N/A     |
| 5.7.7DV.2                                   | <i>Summation of touch currents not exceeding the limits of ES2 exception per Clause 5.7.7(a)(1)</i>   |                 | N/A     |
| 5.7.7DV.3                                   | <i>Clause 5.7.7(a)(2) replaced with:<br/>Such equipment shall comply with Clause 5.7.5.<br/>The value of S(I1) shall be added to the measured protective conductor current to terminate compliance with the 5% input current limit per phase specified in Clause 5.7.5.</i> |                 | N/A     |

| National Special Requirement to IEC 62368-1 |  |                 |         |
|---|--|-----------------|---------|
| Clause                                      | Requirement + Test   | Result - Remark | Verdict |
| 5.7.7.1DV                                   | <p><i>Limitation of touch current due to ringing signals</i></p> <p><i>Equipment containing input telecommunication network leads over which ringing voltages are applied to the equipment shall be tested using the circuit of Figure 5.7.7.1DV.1 for mains-connected equipment or Figure 5.7.7.1DV.2 for other equipment. For any position of the selector switches, the total touch current including consideration of 5.7.7 shall not exceed the relevant limits for ES2 specified in Table 4, unless the equipment complies with 5.7.7(a) with the protective conductor current due to ringing signal taken into account. An EUT that receives ringing voltages on up to three telecommunication network connection ports shall have simulated ringing applied to each network connection.</i></p> <p><i>For four or more ports receiving ringing, simulated ringing shall be applied to three ports and an additional 3% (rounding down) of the remaining ports.</i></p> <p><i>Compliance is checked by the following tests, which are conducted using the measuring network described in IEC 60990, Figure 4. Simulated ringing at 120 V, 50 to 60 Hz, shall be applied to ringing input telecommunication network leads, either one lead at a time or connected together. Other telecommunication network leads shall be left disconnected.</i></p> <p><i>Equipment shall be evaluated in each operating state, including ground start. The general test methods of 5.7 shall apply, checking touch current for all positions of switches S1, S2, and S3 in Figure 5.7.7.1DV.1. In case the total touch current exceeds the ES2 limits, the protective conductor current is measured using the test set up of Figure 5.7.7.1DV.1 or Figure 5.7.7.1DV.2 with the measuring instrument replaced with an ammeter having negligible impedance.</i></p> |                 | N/A     |
| 6.5.1DV.1                                   | <p><i>Add the following text to the end of the second, third and fourth paragraphs:</i></p> <p><i>or the insulation of the conductor or cable assembly shall be rated VW-1 or FT-1.</i></p>  |                 | N/A     |

| National Special Requirement to IEC 62368-1 |   |                 |         |
|---|---|-----------------|---------|
| Clause                                      | Requirement + Test  | Result - Remark | Verdict |
| 6.5.1DV.2                                   | <p>Add the following after the third paragraph:<br/> <i>PS3 wiring outside a fire enclosure shall comply with single fault testing in B.4. Alternatively, the following constructions are considered to comply:</i></p> <ul style="list-style-type: none"> <li>- <i>conductors provided with overcurrent protection in accordance with Article 240 of the National Electrical Code, NFPA 70, and the Canadian Electrical Code, Part I, C22.1, Section 14;</i></li> <li>- <i>internal conductors supplied by a power source that is limited to the output voltage and current values specified in Table Q.1 or is limited to the output voltage values and provided with an overcurrent protective vice with a rated current value as specified in Table Q.2;</i></li> <li>- <i>interconnecting cables supplied by a limited power source (see Q.1);</i></li> <li>- <i>a 20-A protective vice used with any size wire in the primary.</i></li> </ul> |                 | N/A     |
| 6.7DV.1                                     | <p><i>Safeguards against electrically-caused fire due to overvoltage from power line crosses</i></p> <p><i>Equipment with external circuits intended for connection to a telecommunication network that uses outside cable subject to overvoltage from power line failures shall comply with Annex DVI.</i></p>   |                 | N/A     |
| 10.6.1DV                                    | <p><i>For telecommunication-network connected equipment, see Annex DVJ.</i></p>   |                 | N/A     |
| F.1DV                                       | <p><i>F.1DV.1 See Annex DVK for U.S. and Canadian markings and instructions.</i></p>  |                 | N/A     |
| F.3.3.9DV.1                                 | <p><i>Equipment with output terminals</i></p> <p><i>Output terminals provided for supply of other equipment except mains supply shall be marked with the nominal output voltage and frequency, and, in addition, the maximum output current or power, unless the terminals are marked with the type references of the equipment which are permitted to be connected. When intended to be installed or interconnected in the field by a skilled person, the Class of wiring shall be marked adjacent to the terminals.</i></p>   |                 | N/A     |
| G.4.3DV                                     | <p><i>Delete the 2nd sentence reference to “banana plug” of the EXAMPLE.</i></p>  |                 | N/A     |
| G.7.2DV                                     | <p><i>In the second paragraph, replace the reference to Table G.4 with a reference to Table G.7ADV.1.</i></p>   |                 | N/A     |
| G.7ADV                                      | <p><i>Additional requirements: Power supply cords – tachable and non-detachable</i></p>   |                 | N/A     |

| National Special Requirement to IEC 62368-1 |   |                 |         |
|---|---|-----------------|---------|
| Clause                                      | Requirement + Test  | Result - Remark | Verdict |
| G.7ADV.1                                    | <p><i>General</i></p> <p><i>Flexible cords and plugs are permitted for movable equipment, hand-held equipment, stationary equipment and transportable equipment, and for fixed equipment where the fastening means and mechanical connections of the equipment are signed to permit removal for maintenance and repair.</i></p>   |                 | N/A     |
| G.7ADV.2                                    | <p><i>Methods of connection</i></p> <p><i>Flexible cords shall be provided with an attachment plug for connection to the branch circuit.</i></p>  |                 | N/A     |
| G.7ADV.3                                    | <p><i>Sizing and ratings</i></p> <p><i>The attachment plug configuration shall be one that is rated not less than 125 percent of the current rating of the equipment.</i></p> <p><i>Power supply cords shall have conductors with cross-sectional areas sufficient for the rated current of the equipment. Conductors shall be sized based on the requirements in the National Electrical Code (NEC), NFPA 70, and the Canadian Electrical Code, Part I, C22.1.</i></p> <p><i>Table G.7ADV.1 provides allowable ampacity for flexible cords and cables based on Table 400.5(a)(1) of the NEC. See Table 400.5(a)(2) of the NEC for ampacity information on portable power cables.</i></p> <p><i>For equipment with a rated current up to and including 2 A, 20 AWG is acceptable provided that the mains plug is provided with a 2 A fuse maximum and the equipment is not provided with a socket outlet.</i></p> |                 | N/A     |
| G.7ADV.4                                    | <p><i>Serviceability</i></p> <p><i>Power supply cords and cord sets shall incorporate flexible cords suitable for the particular application or shall be of a type at least as serviceable for the particular application.</i></p> <p><i>Table G.7ADV.2 lists common applications and associated suitable cord types.</i></p>   |                 | N/A     |
| G.7ADV.5.<br>1                              | <p><i>Minimum length</i></p> <p><i>The minimum length of a power supply cord shall be 1,5 m unless it is intended for a special installation, such as a dedicated equipment intended to be mounted near a mains socket-outlet.</i></p> <p><i>For equipment provided with an external power supply, the minimum length of the power supply cord shall be 0,5 m, provided that the total length of the conductive path from the receptacle to the equipment is 1,5 m or greater.</i></p>  |                 | N/A     |

| National Special Requirement to IEC 62368-1 |   |                 |         |
|---|---|-----------------|---------|
| Clause                                      | Requirement + Test  | Result - Remark | Verdict |
| G.7ADV.5.2                                  | <p><i>Maximum length</i></p> <p><i>For equipment intended for installation in ITE Rooms, the length of a power supply cord shall not exceed 4,5 m.</i></p> <p><i>For other intended installations, see Table G.7ADV.2.</i></p>  |                 | N/A     |
| H.2DV                                       | <p><i>Modify H.2 by adding the following text after the second dashed paragraph in a):</i></p> <p><i>Continuous ringing signals shall:</i></p> <ul style="list-style-type: none"> <li>- <i>be located only in areas where a skilled person has access during servicing;</i></li> <li>- <i>be so located and guarded that unintentional contact with such parts is unlikely during servicing by a skilled person, or be provided with a marking to warn a skilled person of the presence of continuous ringing signals</i></li> <li>- <i>and not become accessible to an ordinary person under single fault conditions.</i></li> </ul>   |                 | N/A     |
| H.4DV.1                                     | <p><i>Other telecommunication signals:</i></p> <p><i>Telecommunication signalling systems (e.g., some message waiting systems) using voltages or current, or both, greater than those specified in 5.2.1.1 and 5.2.1.2 shall be permitted if they comply with the following:</i></p> <ul style="list-style-type: none"> <li>- <i>continuous signal: For a signal of duration greater than 5 s, the current through the relevant measuring instrument scribed in IEC 60990:1999, Figure 4, shall be not greater than 7.1 mA peak a.c., or 30 mA d.c., or the limit shown in Figure H.4DV.1 for combinations of a.c. and d.c., when measured in accordance with 5.7.</i></li> <li>- <i>intermittent signal: For a signal of duration less than 5 s, the current through the relevant measuring instrument scribed in IEC 60990:1999, Figure 4, shall be not greater than the limit specified in Figure H.4DV.2. The signal shall be followed by a quiet interval of at least 1 s before the next intermittent signal. During the quiet interval, either the voltage is less than 56,6 V d.c., or the current measured is less than 0,5 mA.</i></li> </ul> |                 | N/A     |

| National Special Requirement to IEC 62368-1 |   |                 |         |
|---|---|-----------------|---------|
| Clause                                      | Requirement + Test  | Result - Remark | Verdict |
| M.2.1DV                                     | <p><i>Battery packs with sealed secondary cells and batteries (other than button) containing alkaline or other non-acid electrolyte and used in stationary equipment shall comply with either IEC 62133, UL 2054 or UL 1973.</i></p> <p><i>Additionally, such battery packs that rely on solid-state circuits and software controls as safeguards shall comply with either the requirements in UL 1973 for System Safety Analysis (5.7) and Protective Circuit and Controls (5.8), or similar requirements in an appropriate standard for electronic safety-related controls that are suitable for investigation of such protection of secondary cells and batteries.</i></p> |                 | N/A     |
| P.4.1DV<br>DE                               | <p>Additional text added to correct for editing error:<br/>For metalized coatings, clearances and creepage distances for pollution degree 3 shall be maintained instead of the tests of P.4.2DV.1.</p>  |                 | N/A     |
| P.4.2DV<br>DE                               | <p>Added test requirements text from Clause P.5 as new Clause P.4.2DV DE to correct for editing error.</p>  |                 | N/A     |
| P.5DV DE                                    | <p>Clause P.5 relocated to P.4.1 and P.4.2</p>  |                 | N/A     |
| U.1DV D1                                    | <p>Added the following text:<br/>The outer enclosure housing a CRT shall have no opening that exceeds 130 mm<sup>2</sup> unless the minor dimension of the opening is 10 mm or less.</p>  |                 | N/A     |
| Table<br>W.3DV<br>DE                        | <p>Modify Table W.3 by replacing the entry for 1.2.8.14 in the first column with the following to correct a typographical error:<br/>TNV-3 CIRCUIT<br/>TNV CIRCUIT<br/>– whose normal operating voltages exceed the limits for an SELV circuit under normal operating conditions and<br/>– on which overvoltages from telecommunication networks and cable distribution systems are possible</p>  |                 | N/A     |
| Annex<br>DVA                                | <p>(normative) Canadian and U.S. regulatory-based requirements</p>  |                 | N/A     |
| Annex<br>DVB                                | <p>(normative) Equipment used in health care facilities</p>   |                 | N/A     |
| Annex<br>DVC                                | <p>(normative) Under kitchen cabinet equipment.</p>   |                 | N/A     |
| Annex<br>DVD                                | <p>(informative) D.C. powered equipment and centralized d.c. power systems (DC mains)</p>   |                 | N/A     |



| National Special Requirement to IEC 62368-1 |   |                 |         |
|---|---|-----------------|---------|
| Clause                                      | Requirement + Test  | Result - Remark | Verdict |
| Annex DVE                                   | (normative) UL and CSA component requirements (mandatory).  |                 | N/A     |
| Annex DVF                                   | (normative) UL and CSA component requirements (alternative to IEC standards)                        |                 | N/A     |
| Annex DVG                                   | (normative) UL and CSA component requirements (alternative)   |                 | N/A     |
| Annex DVH                                   | (normative) Permanently connected equipment – mains connections                                     |                 | N/A     |
| Annex DVI                                   | (normative) Safeguards against electrically-caused fire due to overvoltage from power line crosses. |                 | N/A     |
| Annex DVJ                                   | (normative) Acoustic tests for telecommunications equipment   |                 | N/A     |
| Annex DVK                                   | (normative) Canadian and U.S. marking and instructions  |                 | N/A     |

-END-

Model: FWE0x0yBz, MWA0x0yBz



Picture 1



Picture 2

Model: FWE0x0yBz, MWA0x0yBz



Picture 3

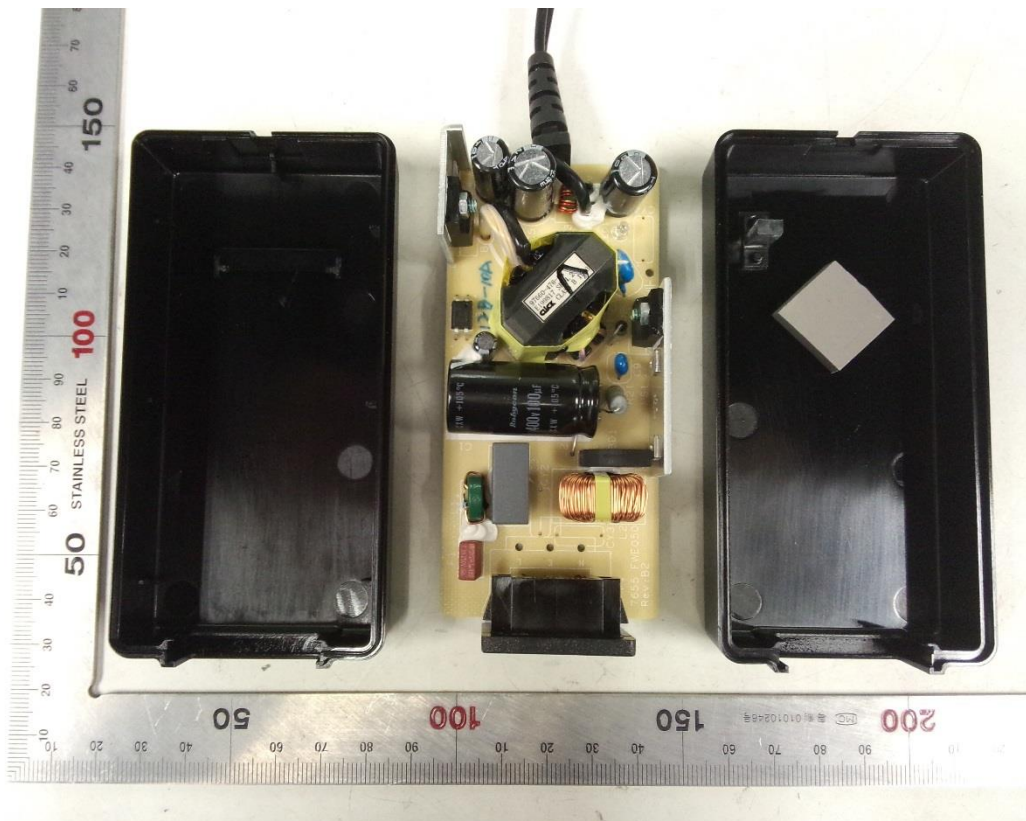

Picture 4

Model: FWE0x0yBz, MWA0x0yBz

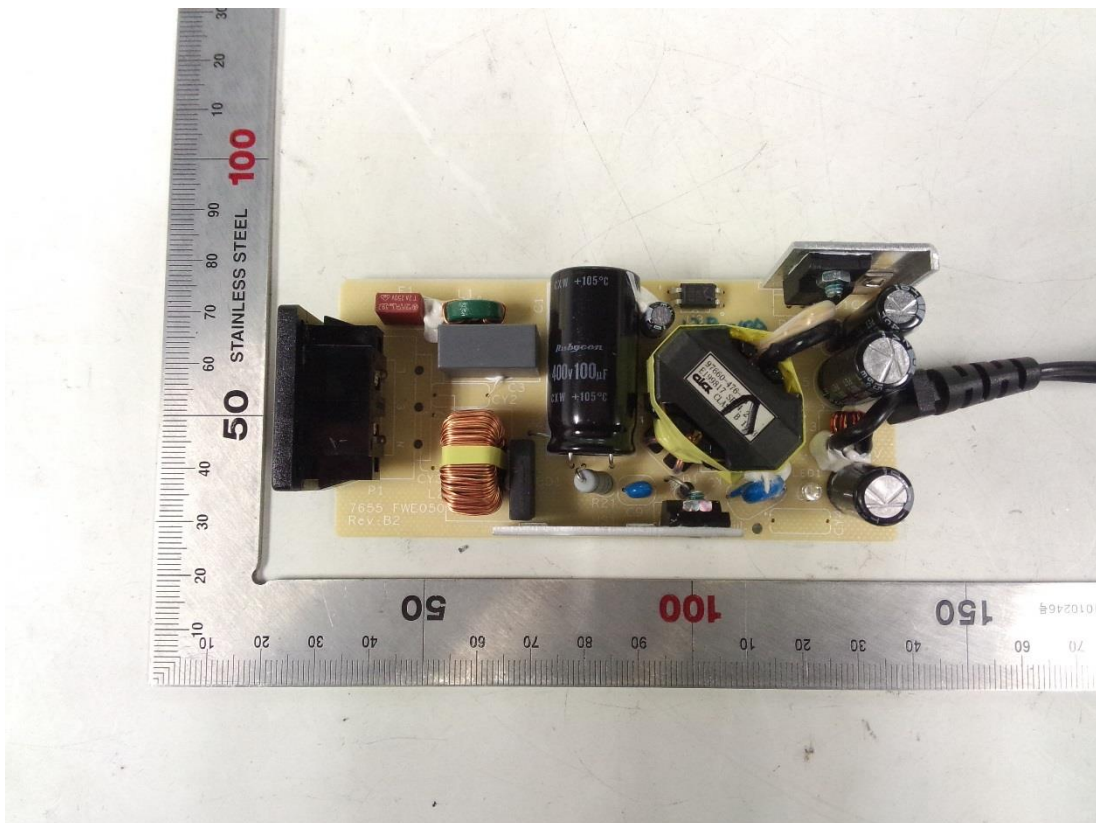

Picture 5

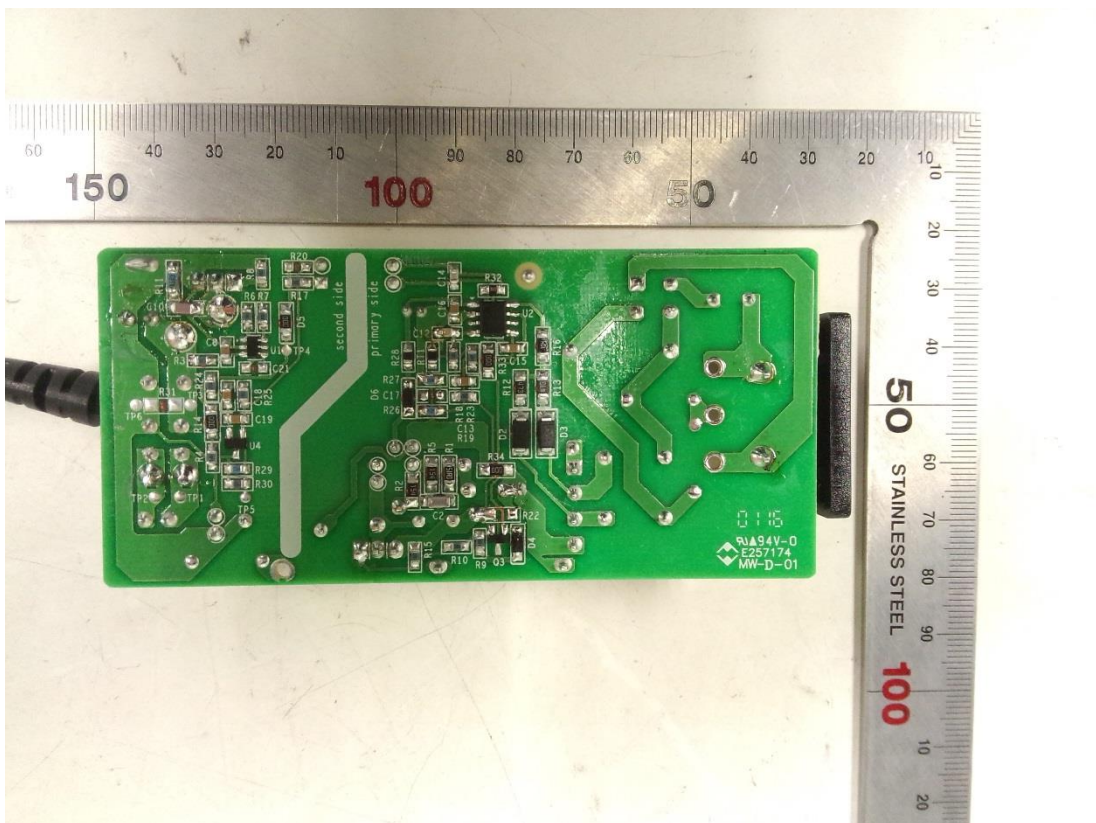

Picture 6

Model: FWE0x0yBz, MWA0x0yBz

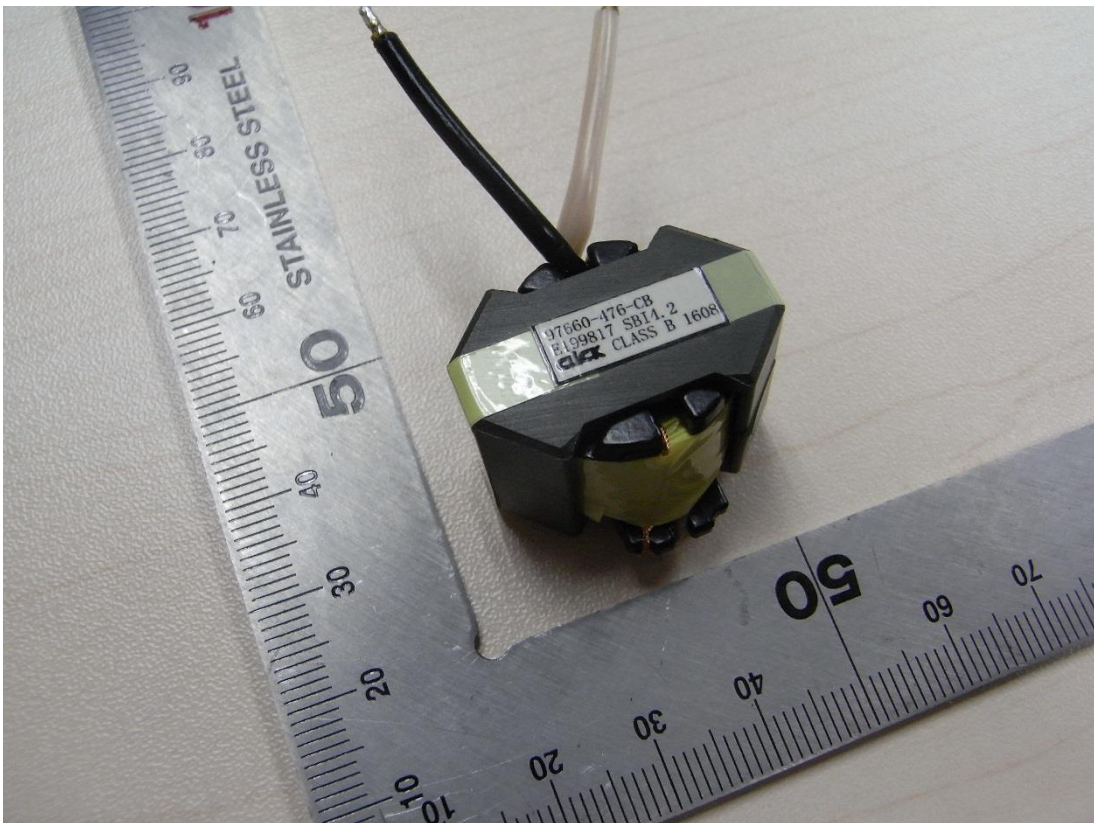

Picture 7

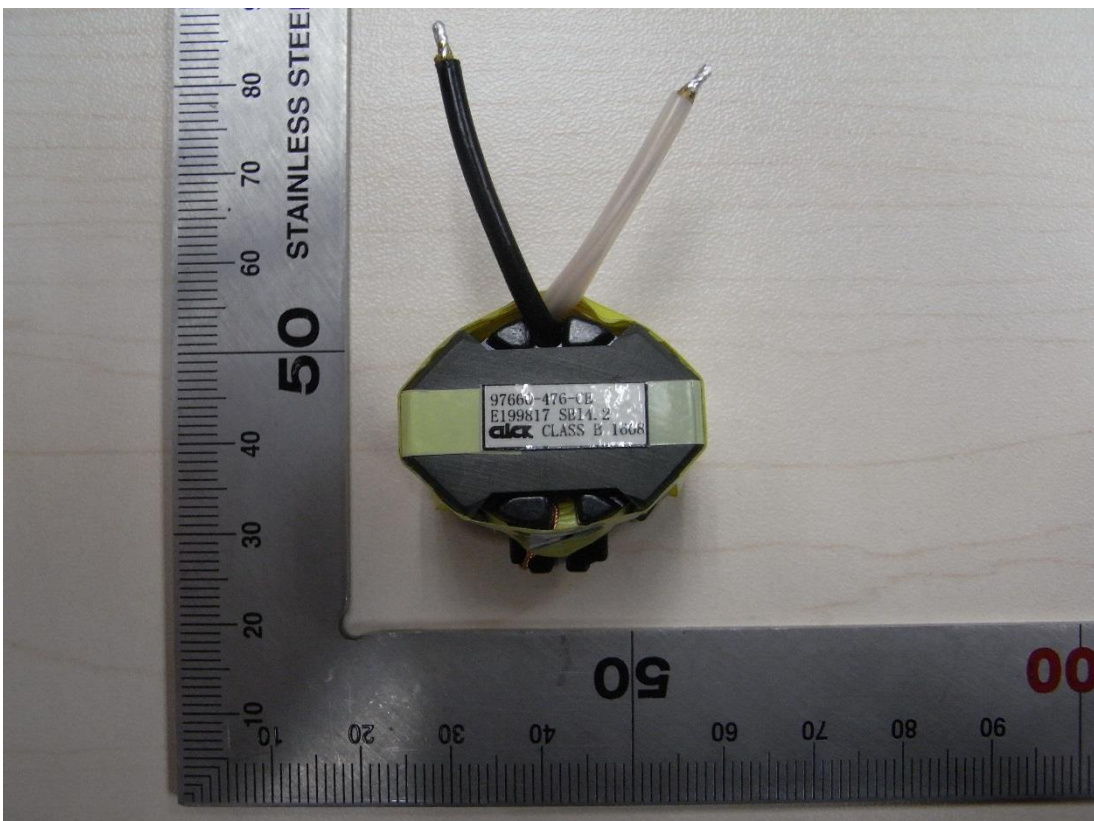

Picture 8

Model: FWE0x0yBz, MWA0x0yBz

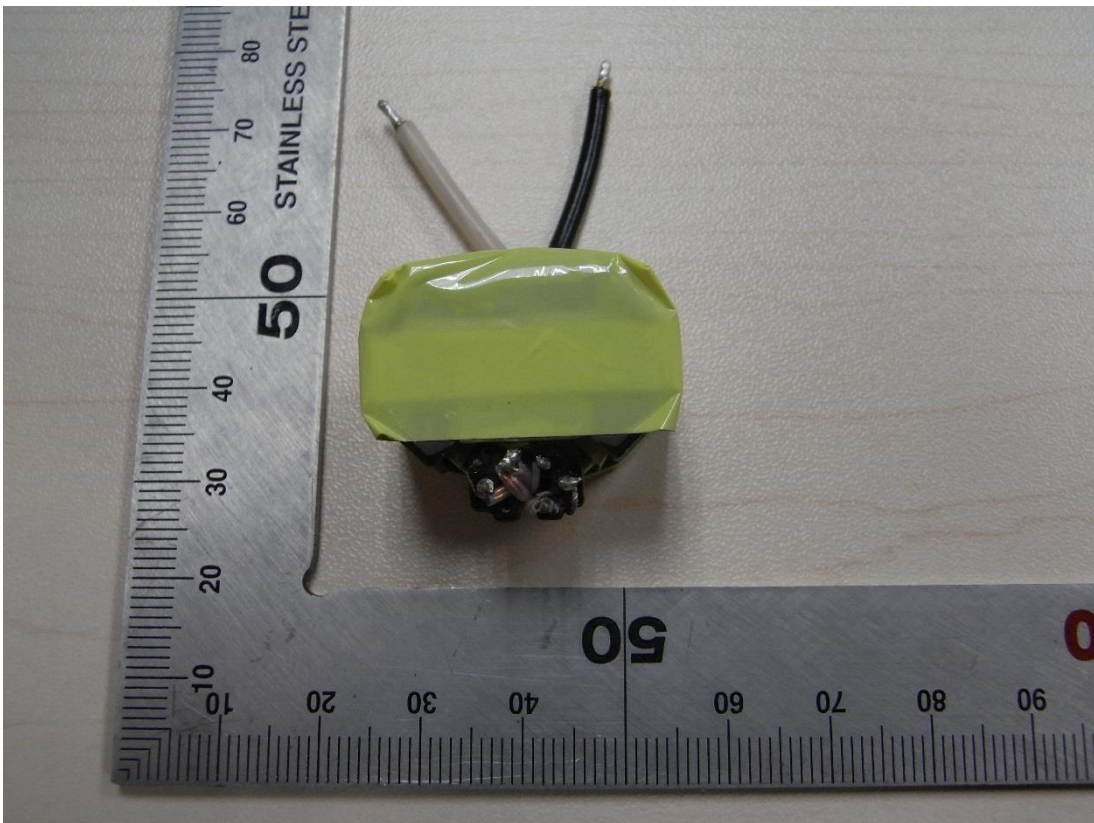

Picture 9

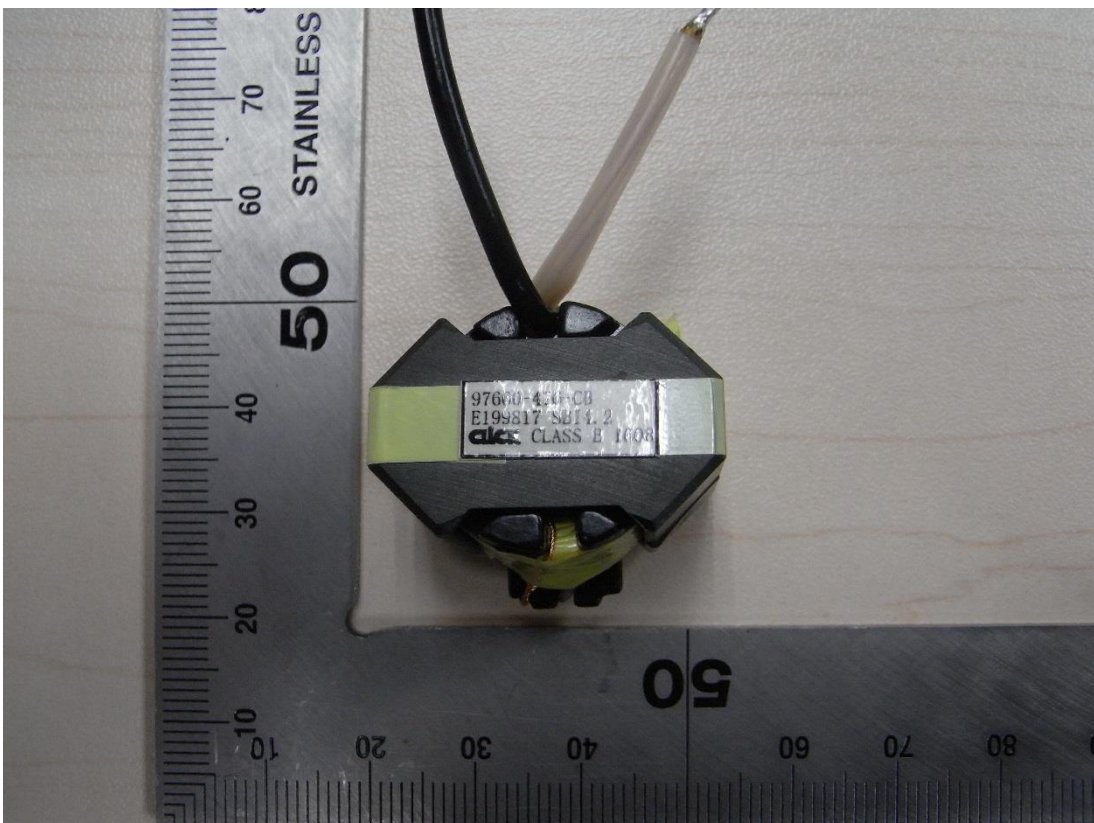

Picture 10

Model: FWE0x0yBz, MWA0x0yBz

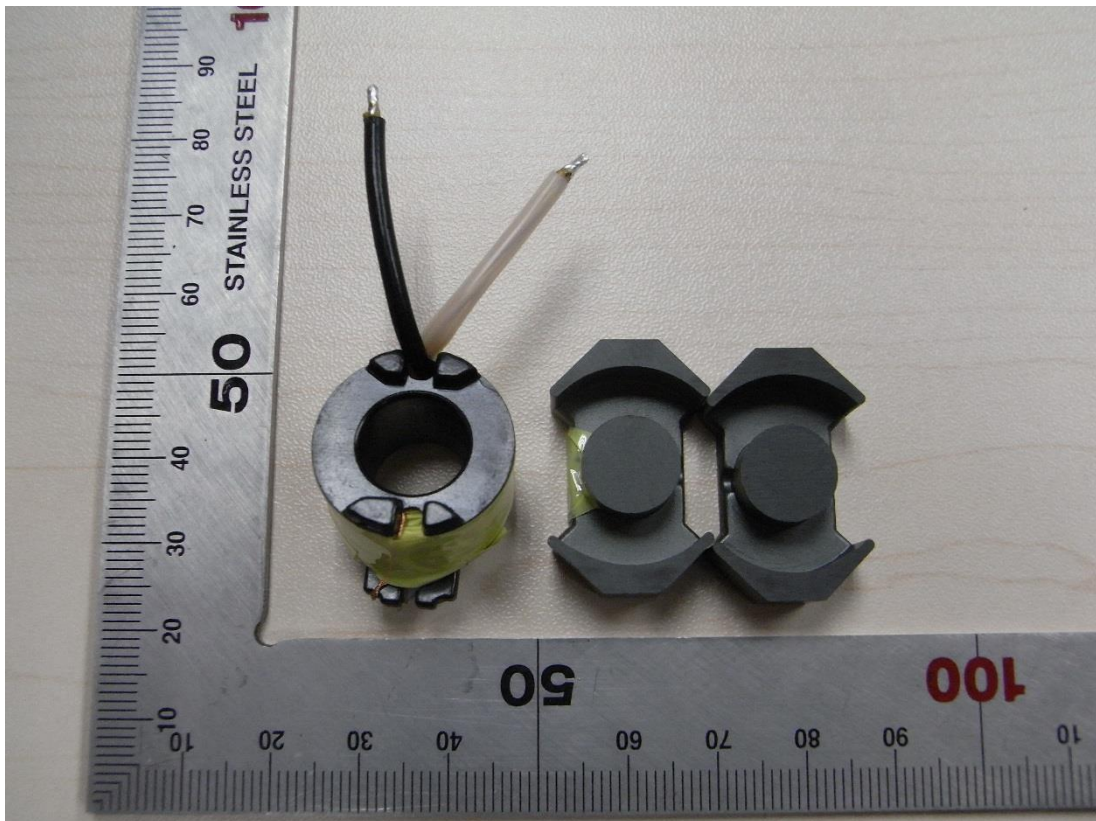

Picture 11

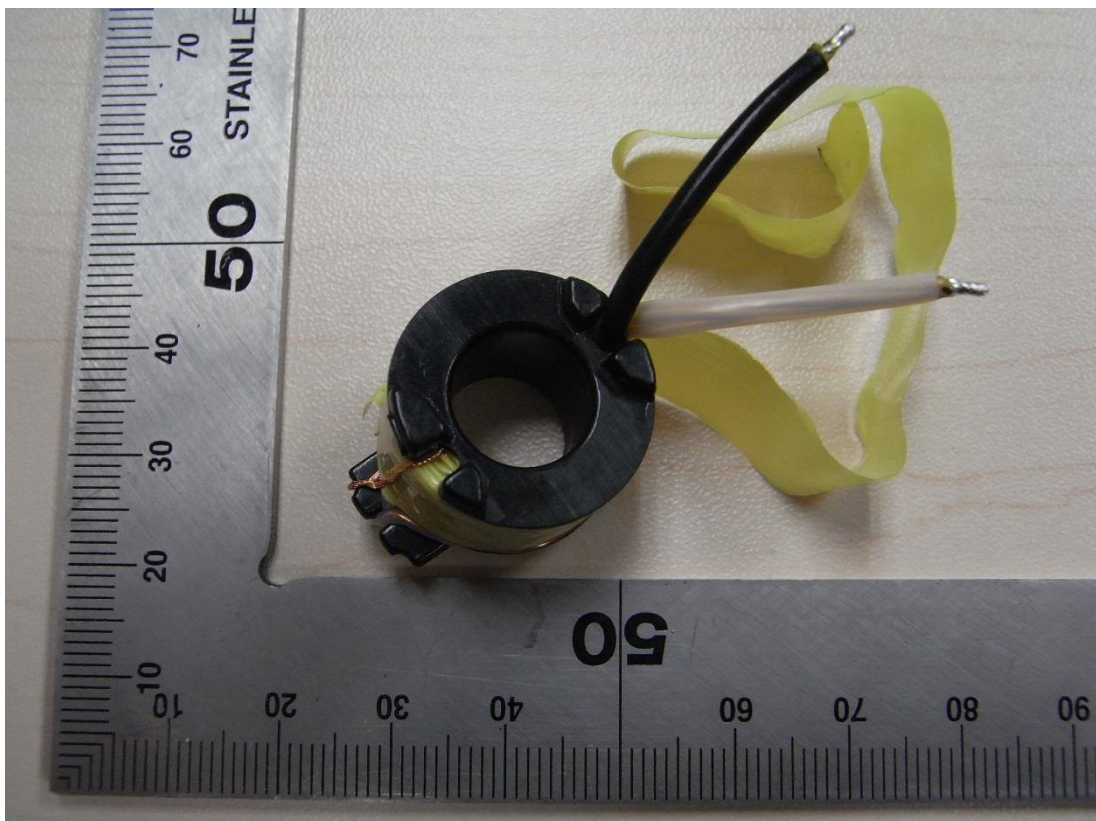

Picture 12

Model: FWE0x0yBz, MWA0x0yBz

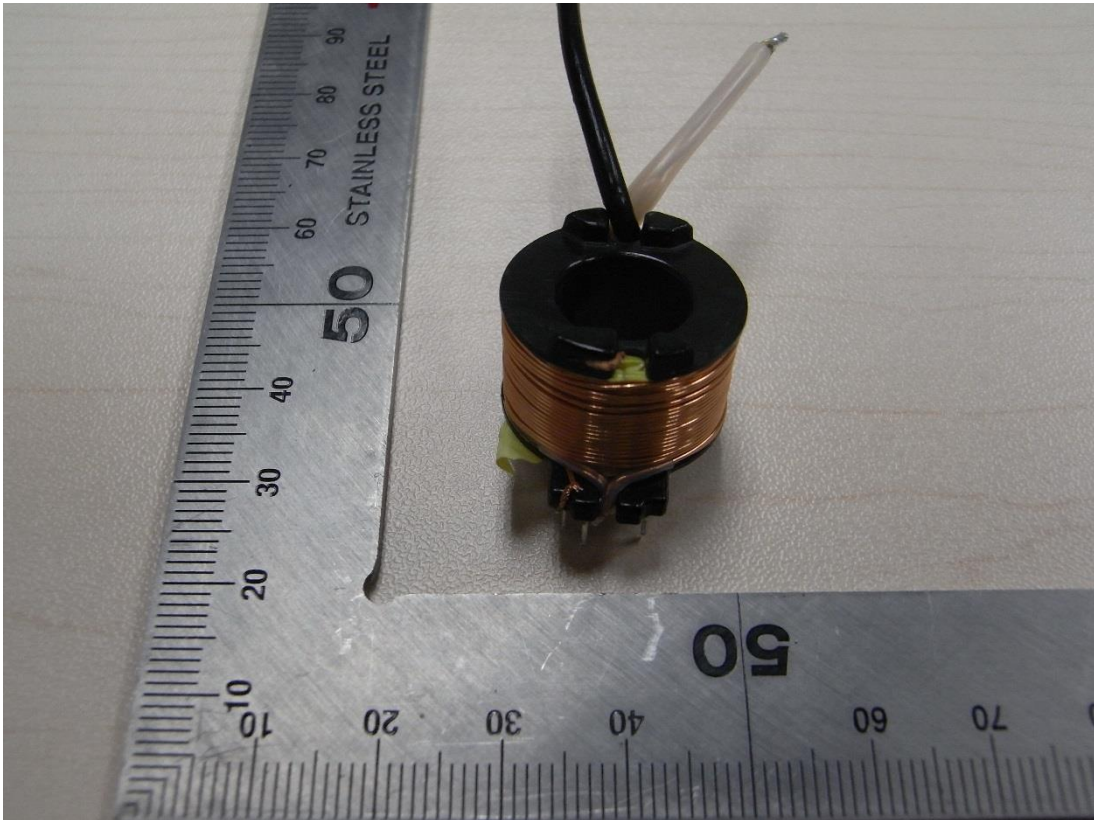

Picture 13

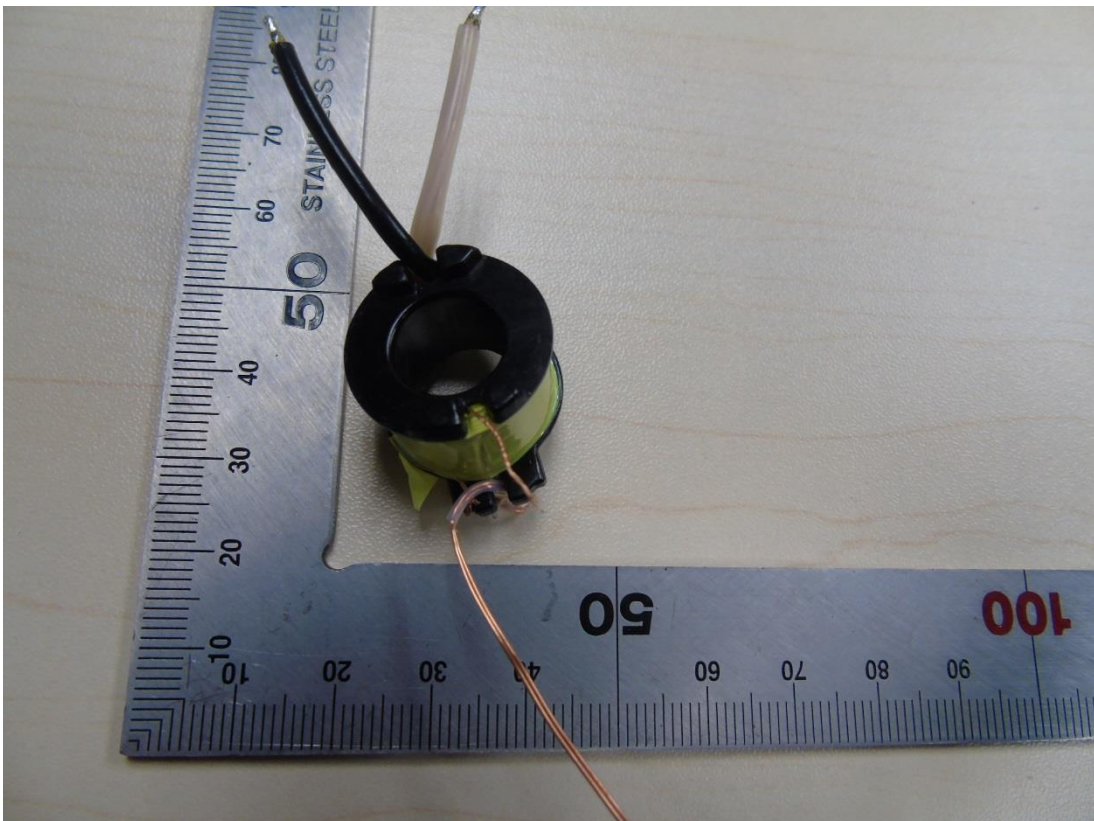

Picture 14



Model: FWE0x0yBz, MWA0x0yBz

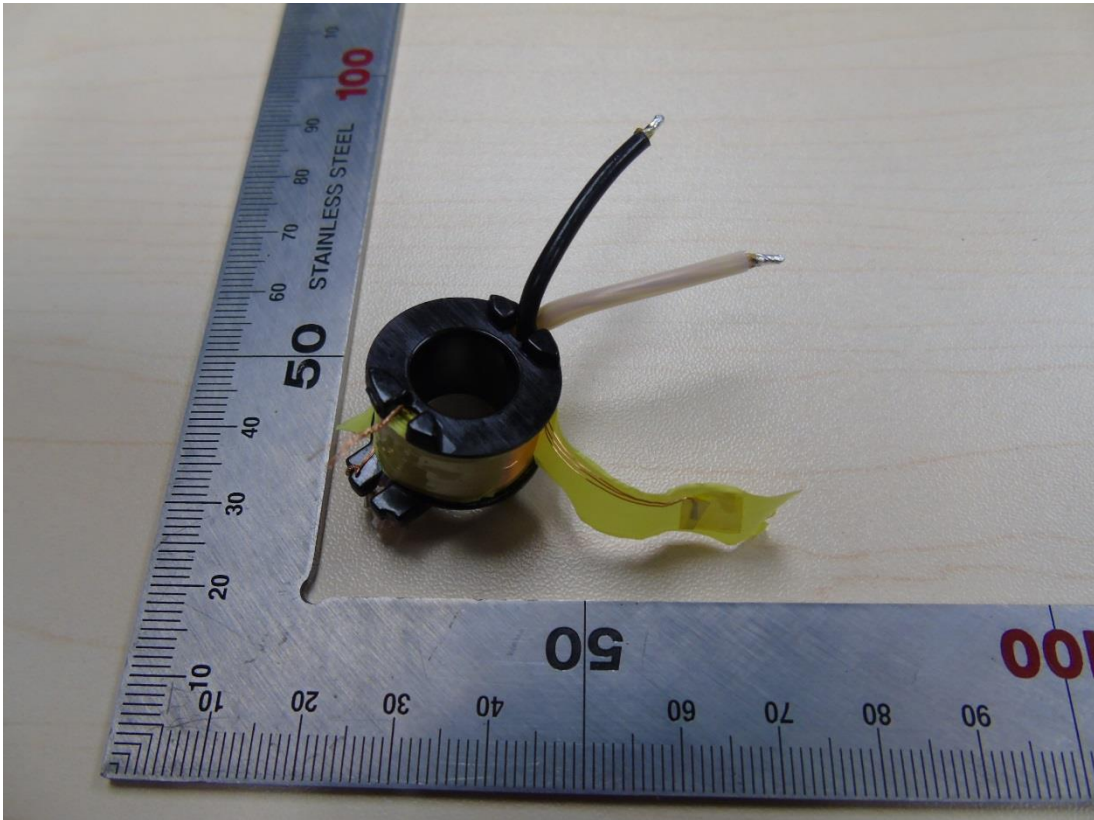

Picture 15

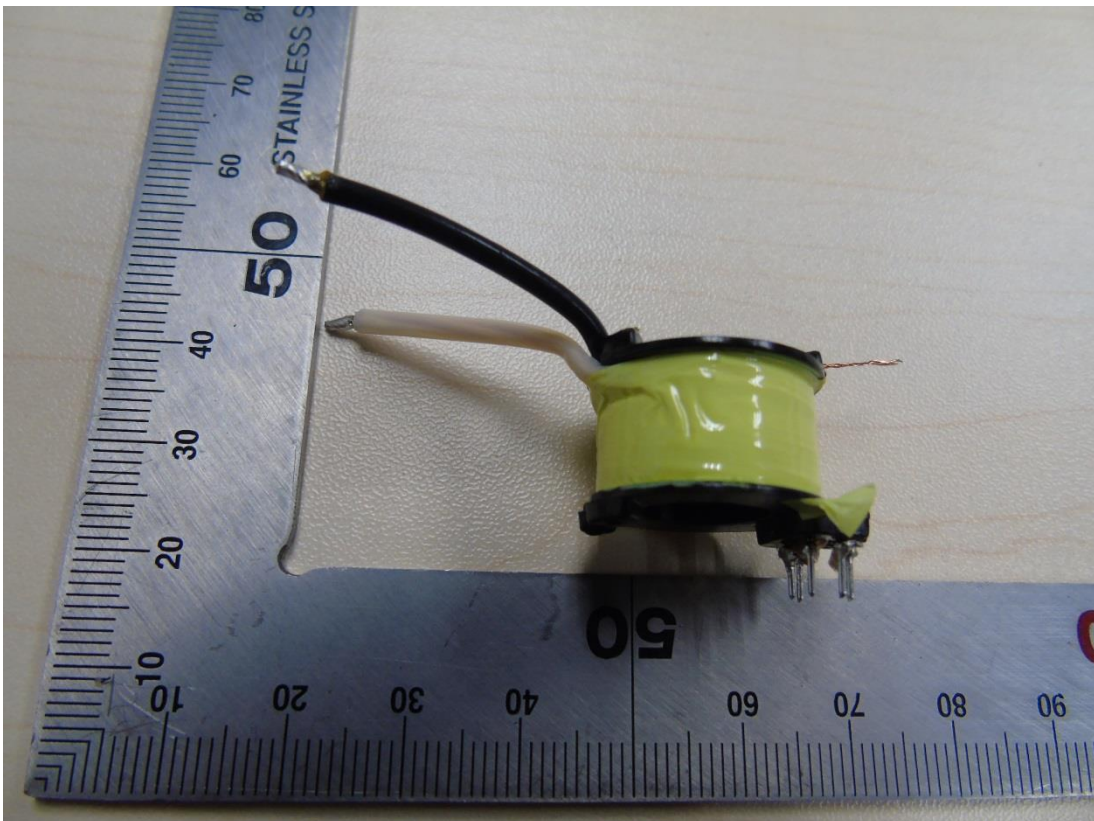

Picture 16

Model: FWE0x0yBz, MWA0x0yBz

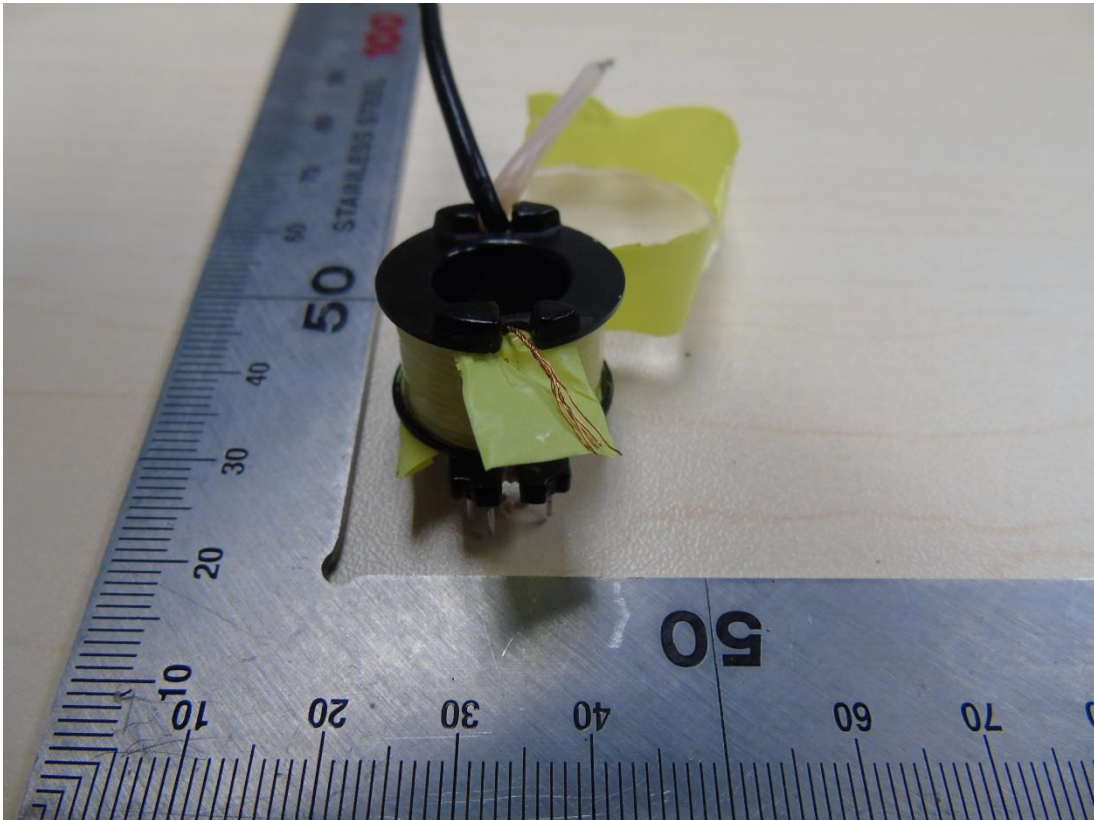

Picture 17

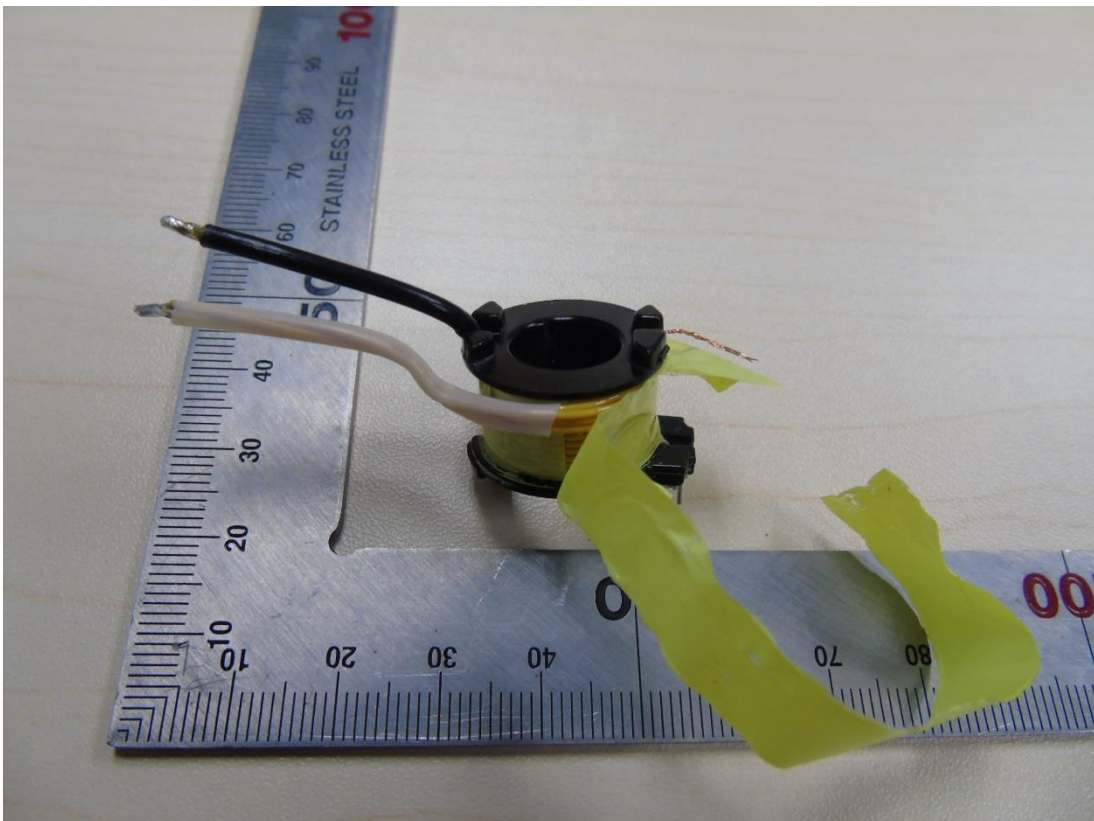

Picture 18

Model: FWE0x0yBz, MWA0x0yBz



Picture 19

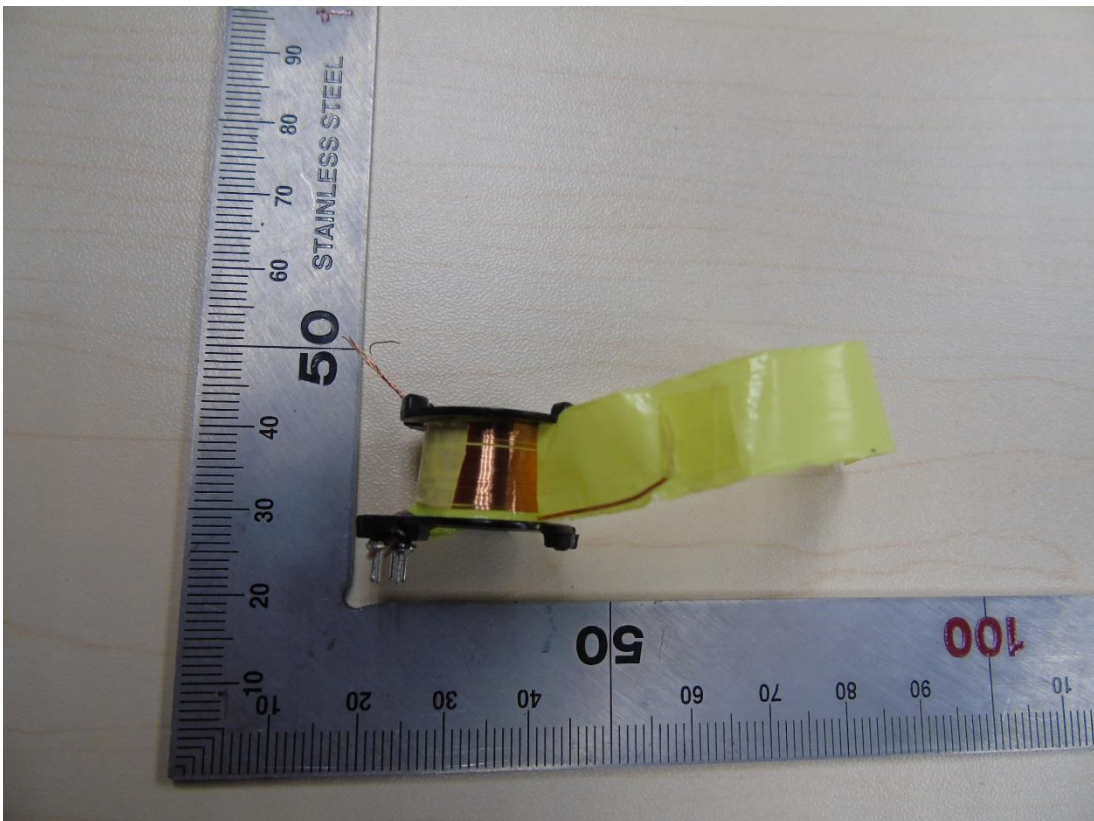

Picture 20

Model: FWE0x0yBz, MWA0x0yBz

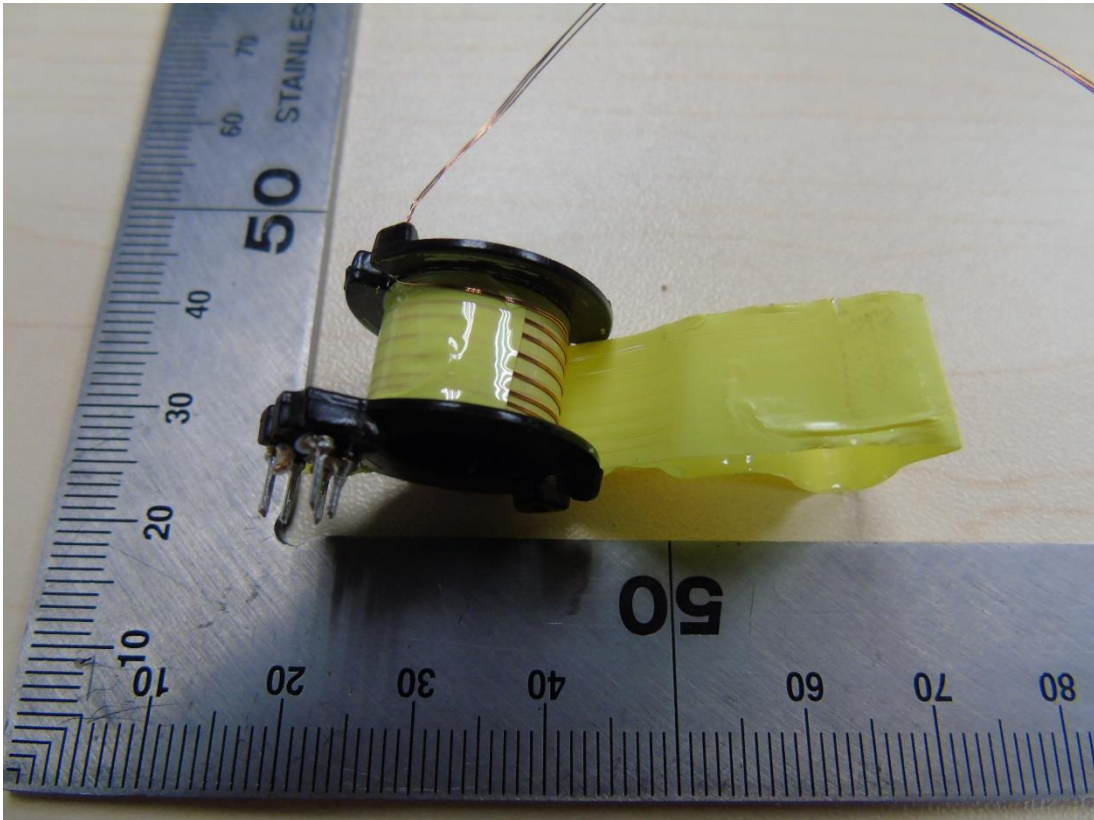

Picture 21

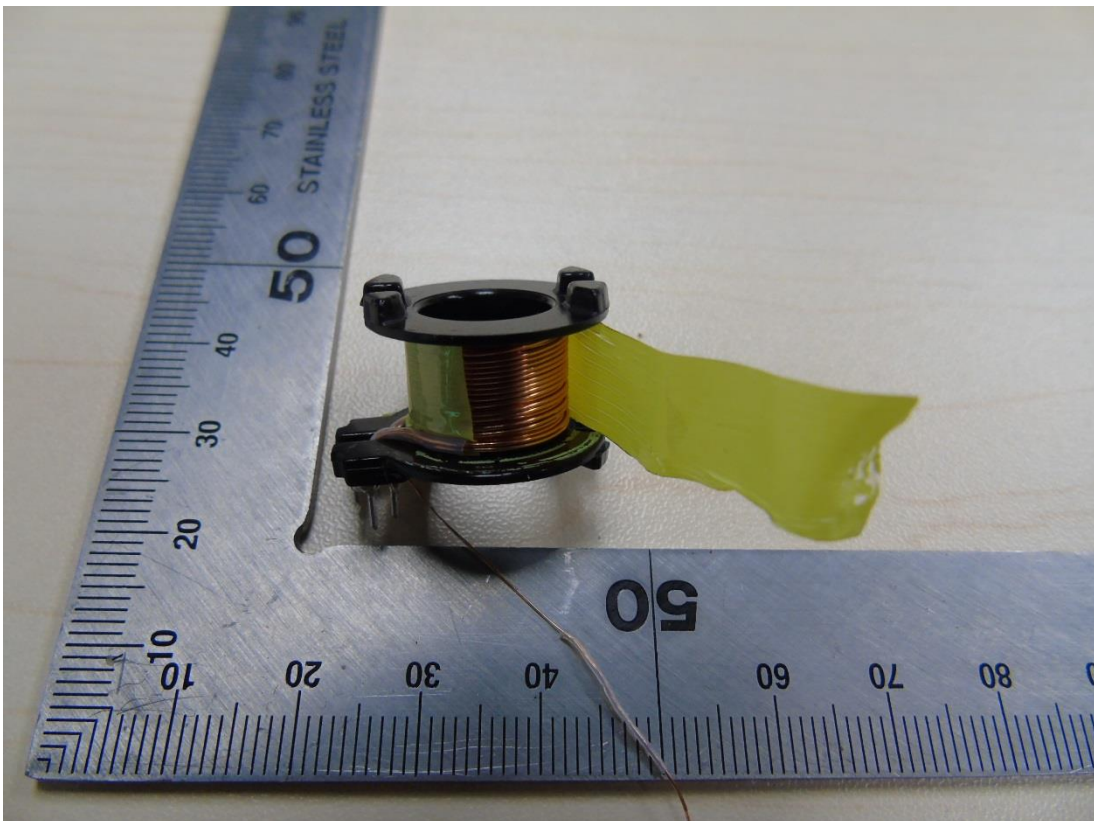

Picture 22

Model: FWE0x0yBz, MWA0x0yBz



Picture 23

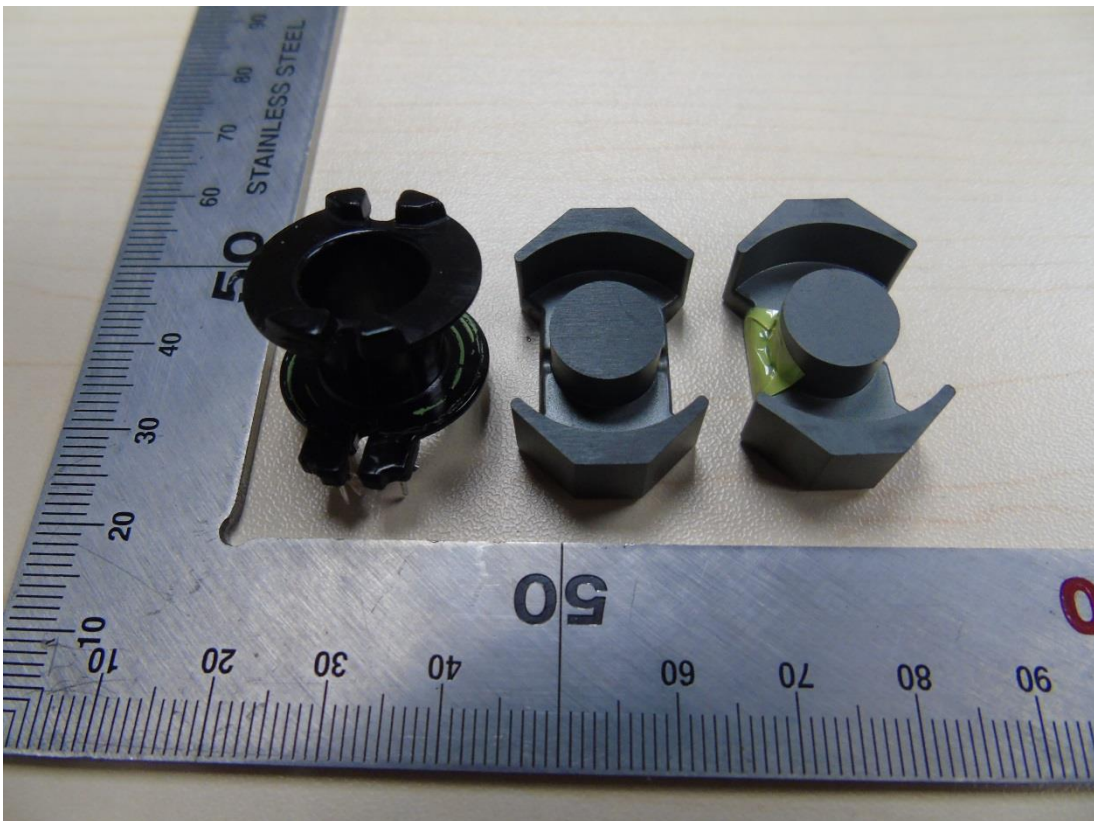

Picture 24

Model: FWE0x0yBz, MWA0x0yBz

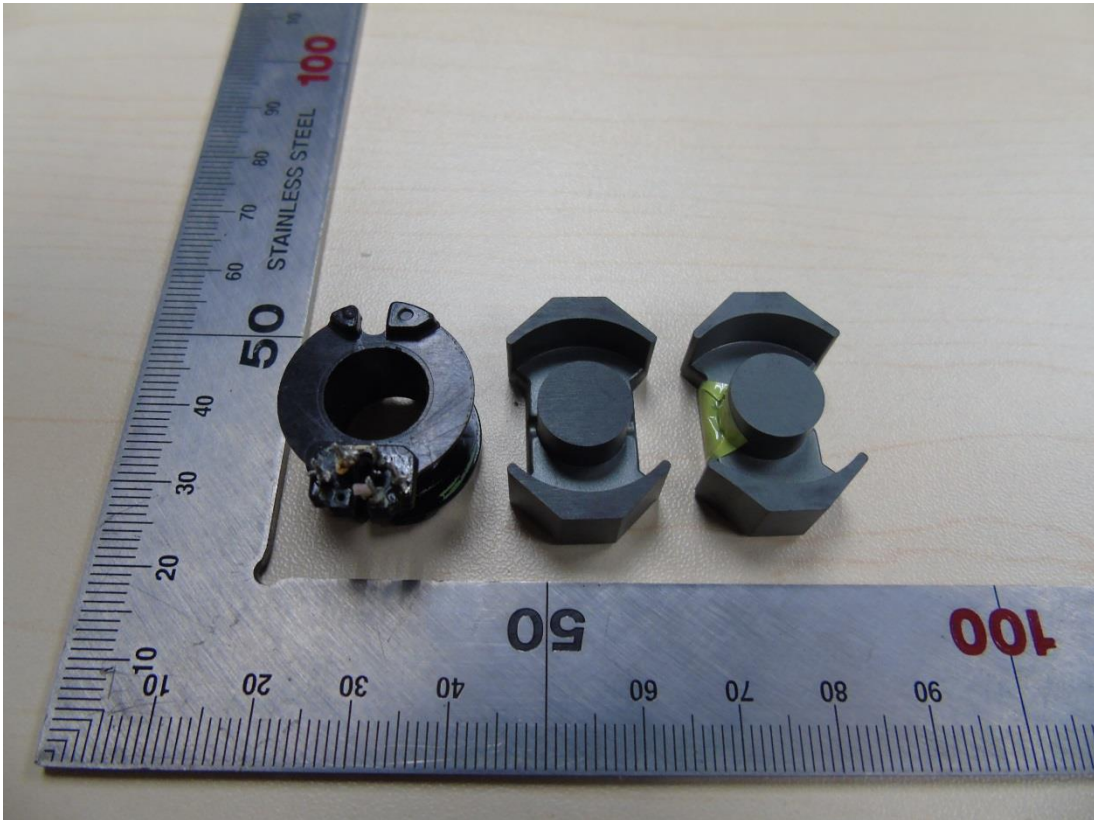

Picture 25