

SFP-10G-WB40-H

10G Fiber SFP+ Transceiver WDM-B, Single Mode 40Km / LC/ Tx:1330nm Rx: 1270nm, 0°C~70°C
(HP H3C Compatible)

Features



- ▶ 11.1Gbps Data Links
- ▶ Up to 40km Transmission on SMF
- ▶ Single Mode Fiber Tx:1330 Rx:1270
- ▶ 2-Wire Interface with Integrated Digital Diagnostic Monitoring
- ▶ EEPROM with Serial ID Functionality
- ▶ Hot-Swappable SFP+ Design
- ▶ Compliant with SFP+ Multi-Source Agreement
- ▶ Single LC Connector
- ▶ Single +3.3V Supplied Power
- ▶ SFP-8472 Compliant
- ▶ SFP-8431 Compliant
- ▶ RoHS Compliant
- ▶ Operating Temperature Range: -0° to 70° C
- ▶ 5-Year Warranty



▶ Dimensions (unit = mm)

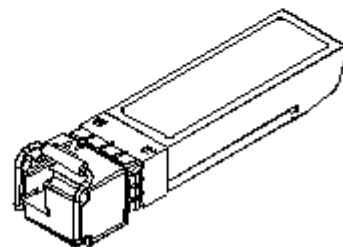
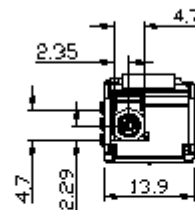
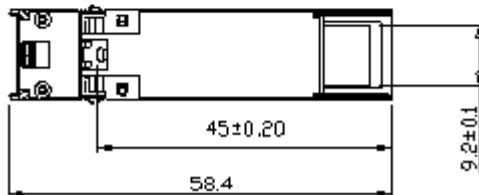
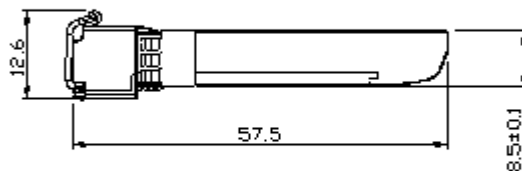
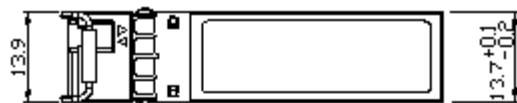

► Specifications

Technology

Standards	IEEE 802.3ae
Transfer Rate	10.3125Gbps

Max Ratings

Storage Temperature	-40~85° C
Humidity	5~95% non-condensing
Power Supply Voltage	0.3 ~ 4 Volts Max
Signal Input Voltage	Vcc -0.3 ~ +0.3

Recommended Operating Conditions

Operating Temperature	0 ~ 70°C
Power Supply Voltage	3.3 Volts
Power Supply Current	450mA
Data Rate	10.3125 Gbps
Transmission Distance	40km
Fiber Type	Single Mode Fiber 9/125um SMF

Optical Characteristics Tx

Average Launch Power	-6 ~ -1 dBm
Center Wavelength Range	1320-1330-1340nm 1260-1270-1280nm
Single Mode Suppression Ratio	30dB
Spectrum Bandwidth (-20dB)	1nm
Extinction Ratio	3.5

Optical Characteristics Rx

Center Wavelength Range	1260-1270-1280nm 1320-1330-1340nm
Receiver Sensitivity	-14.4dBm
Saturation Power Overload	0.5dBm
Assert Power	-30dBm
Deassert	-14dBm
Hysteresis	0.5 ~ 5 dB

Electrical Interface Characteristics Tx

Power Supply Current	450mA
Differential Data Input Voltage	180 ~ 700 m Vp-p
Differential Line Input Impedance	100 Ohm
Transmitter Fault Output High	2.4V
Transmitter Fault Output Low	-0.3 ~0.8 V

Electrical Interface Characteristics Rx

Differential Data Input Voltage	300 ~ 850 m Vp-p
Differential Line Input Impedance	100 Ohm
Receiver LOS Pull Up Resistor	4.7 ~ 10 KOhm
Data Output Rise/Fall Time	38
LOS Output Voltage-High	2V
LOS Output Voltage-Low	-0.3 ~ 0.4 V

► Pin Assignment

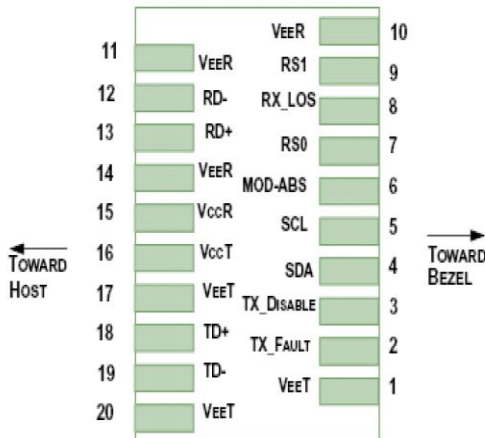

Pin	Symbol	Name/Description	NOTE
1	V _{EET}	Transmitter Ground (Common with Receiver Ground)	1
2	T _{FAULT}	Transmitter Fault.	2
3	T _{DIS}	Transmitter Disable. Laser output disabled on high or open.	3
4	SDA	2-wire Serial Interface Data Line	4
5	SCL	2-wire Serial Interface Clock Line	4
6	MOD_ABS	Module Absent. Grounded within the module	4
7	RS0	Rate Select 0	5
8	LOS	Loss of Signal indication. Logic 0 indicates normal operation.	6
9	RS1	No connection required	1
10	V _{EER}	Receiver Ground (Common with Transmitter Ground)	1
11	V _{EER}	Receiver Ground (Common with Transmitter Ground)	1
12	RD-	Receiver Inverted DATA out. AC Coupled	
13	RD+	Receiver Non-inverted DATA out. AC Coupled	
14	V _{EER}	Receiver Ground (Common with Transmitter Ground)	1
15	V _{CCR}	Receiver Power Supply	
16	V _{CCT}	Transmitter Power Supply	
17	V _{EET}	Transmitter Ground (Common with Receiver Ground)	1
18	TD+	Transmitter Non-Inverted DATA in. AC Coupled.	
19	TD-	Transmitter Inverted DATA in. AC Coupled.	
20	V _{EET}	Transmitter Ground (Common with Receiver Ground)	1

► Interface Circuit

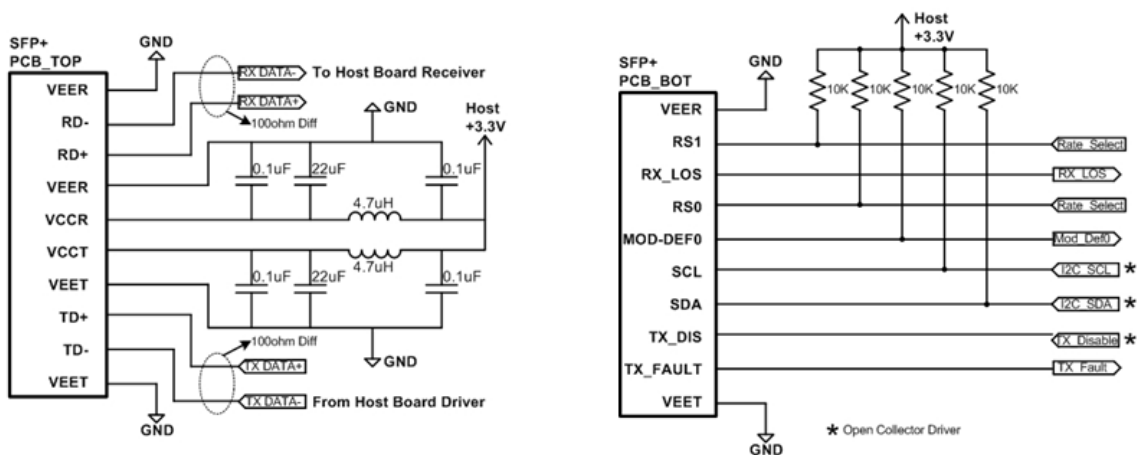

▶ Regulatory Approvals

Feature	Reference	Performance
Electrostatic discharge (ESD)	IEC/EN 61000-4-2	Compatible with standards
Electromagnetic Interference (EMI)	FCC Part 15 Class B EN 55022 Class B (CISPR 22A)	Compatible with standards
Laser Eye Safety	FDA 21CFR 1040.10, 1040.11 IEC/EN 60825-1, 2	Class 1 laser product
Component Recognition	IEC/EN 60950 , UL	Compatible with standards
ROHS	2002/95/EC	Compatible with standards
EMC	EN61000-3	Compatible with standards

▶ Ordering Information

SFP-10G-WA40-H3	10G Fiber SFP+ Transceiver WDM-A, Single Mode 40Km / LC/ Tx:1270nm Rx: 1330nm, 0°C~70°C (HP H3C Compatible)
SFP-10G-WB40-H3	10G Fiber SFP+ Transceiver WDM-B, Single Mode 40Km / LC/ Tx:1330nm Rx: 1270nm, 0°C~70°C (HP H3C Compatible)

Optional Accessories

CBF-LC01LC-SS	LC to LC 1 Meter Single-Mode Simplex Fiber Cable
----------------------	--