

868MHz Antenna JCG402LR-1

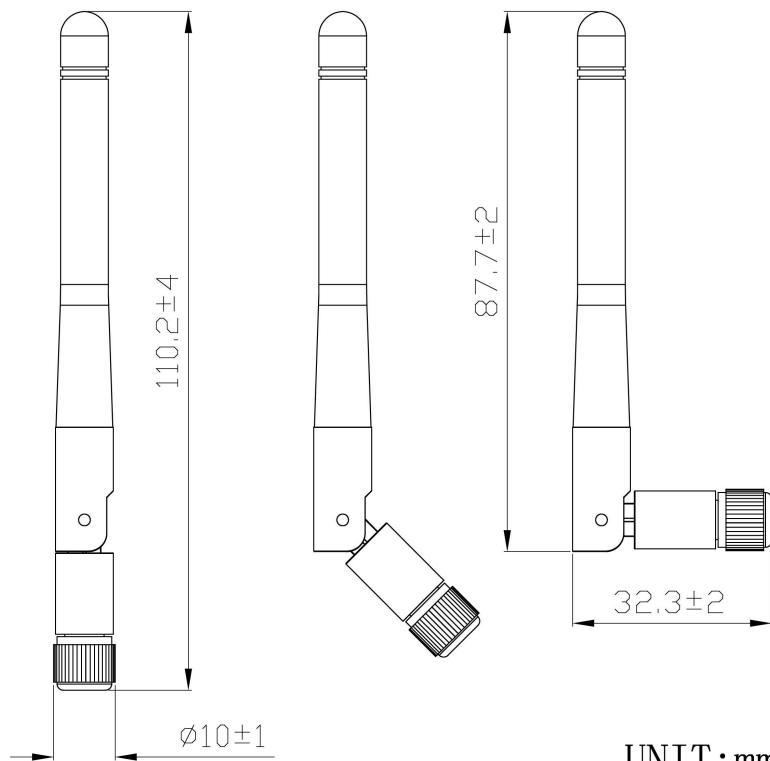

DIMENSIONS



UNIT : mm

JIAXING JINCHANG ELECTRONIC TECHNOLOGY CO.,LTD

Add: 398#, Zhenye Road, South Street, Jiaxing, Zhejiang, China

Http:// www.jinchanggps.com

E-mail: jcgps@vip.163.com

Tel: 86-0573-83692157/83692605/83958637 Fax: 86-0573-83958635

SPECIFICATIONS

Item	Specifications	
Antenna	Frequency	868±5MHz
	Band Width	10MHz
	Polarization	Linear
	Gain	2dBi (Zenith)
	V.S.W.R	≤2.0
	Impedance	50 Ω
	Connector	SMA Male
	Radiation	Omnidirectional
Environmental	Operating Temperature	-40℃~+85℃
	Vibration	10 to 55Hz with 1.5mm amplitude 2hours
	Environmentally Friendly	ROHS Compliant

Radiation Pattern

