

**Data sheet | Item number: 2092-1122**

1-conductor female connector; push-button; Push-in CAGE CLAMP®; 2.5 mm<sup>2</sup>; Pin spacing 5 mm; 2-pole; 2,50 mm<sup>2</sup>; light gray

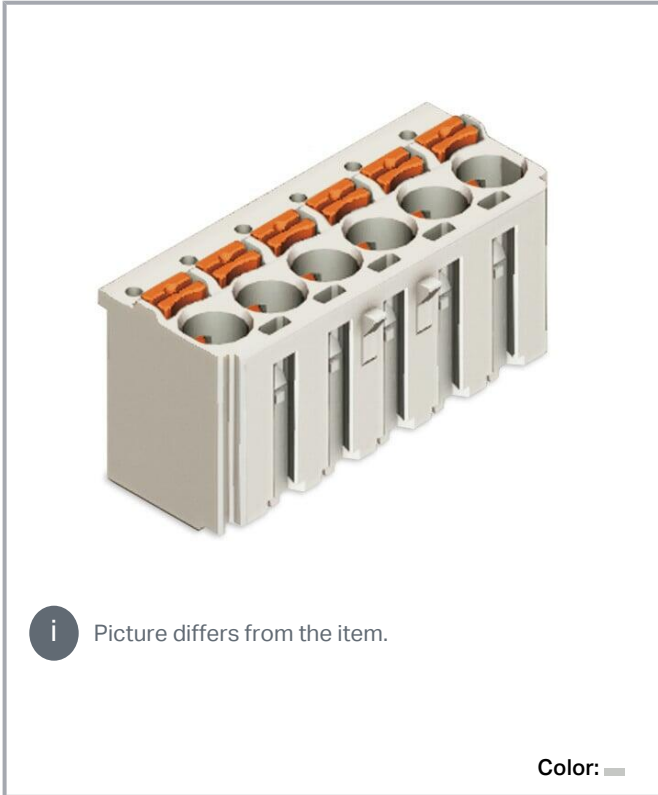

[www.wago.com/2092-1122](http://www.wago.com/2092-1122)



Subject to changes. Please also observe the further product documentation!

WAGO GmbH & Co. KG  
Hansastr. 27  
32423 Minden  
Phone: +49571 887-0 | Fax: +49571 887-169  
Email: [info.de@wago.com](mailto:info.de@wago.com) | Web: [www.wago.com](http://www.wago.com)

Do you have any questions about our products?  
We are always happy to take your call at +49 (571) 887-44222.

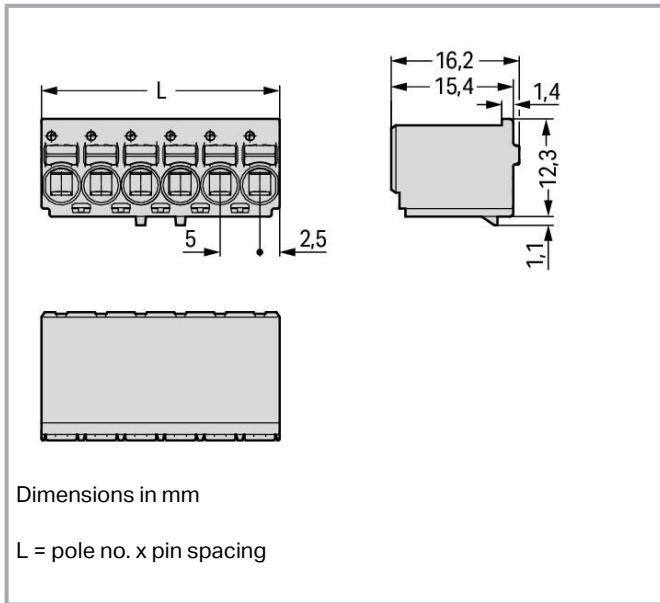

## Item description

- Universal connection of all conductor types
- Simple, push-in termination of solid and ferruled conductors
- Easy-to-use design does not require special tools
- Ability to wire while mated or unmated
- Testing parallel to conductor entry – tip contact
- Also available with gripping plates
- Integrated locking latches prevent accidental disconnection

## Data

### Notes

Safety information

The **picoMAX® Pluggable Connection System** includes connectors without breaking capacity in accordance with DIN EN 61984. When used as intended, these connectors must not be connected /disconnected when live or under load. The circuit design should ensure header pins, which can be touched, are not live when unmated.

Variants:

Direct marking

Other versions (or variants) can be requested from WAGO Sales or configured at <https://configurator.wago.com/>.

## Electrical data

Subject to changes. Please also observe the further product documentation!

WAGO GmbH & Co. KG  
Hansastr. 27  
32423 Minden  
Phone: +49571 887-0 | Fax: +49571 887-169  
Email: [info.de@wago.com](mailto:info.de@wago.com) | Web: [www.wago.com](http://www.wago.com)

Do you have any questions about our products?  
We are always happy to take your call at +49 (571) 887-44222.



## Ratings per IEC/EN

Ratings per	IEC/EN 60664-1
Nominal voltage (III/3)	250 V
Rated impulse voltage (III/3)	4 kV
Rated voltage (III/2)	320 V
Rated impulse voltage (III/2)	4 kV
Nominal voltage (II/2)	630 V
Rated surge voltage (II/2)	4 kV
Rated current	16 A
Legend (ratings)	(III / 2) ≙ Overvoltage category III / Pollution degree 2

## Ratings per UL 1059

Approvals per	UL 1059
Rated voltage UL (Use Group B)	300 V
Rated current UL (Use Group B)	15 A
Rated voltage UL (Use Group D)	300 V
Rated current UL (Use Group D)	10 A

## Connection data

Connection points	2
Total number of potentials	2
Number of connection types	1
Number of levels	1

## Connection 1

Connection technology	Push-in CAGE CLAMP®
Actuation type	Push-button
Actuation direction 1	Operation parallel to conductor entry
Solid conductor	0.2 ... 2.5 mm <sup>2</sup> / 24 ... 12 AWG
Fine-stranded conductor	0.2 ... 2.5 mm <sup>2</sup> / 24 ... 12 AWG
Fine-stranded conductor; with insulated ferrule	0.25 ... 1.5 mm <sup>2</sup>
Fine-stranded conductor; with uninsulated ferrule	0.25 ... 2.5 mm <sup>2</sup>
Strip length	9 ... 10 mm / 0.35 ... 0.39 inches
Pole number	2

Subject to changes. Please also observe the further product documentation!



## Physical data

Pin spacing	5 mm / 0.197 inches
Width	10 mm / 0.394 inches
Height	16.2 mm / 0.638 inches
Depth	13.4 mm / 0.528 inches

## Mechanical Data

Variable coding	Yes
Anti-rotation protection	Yes

## Plug-in connection

Contact type (pluggable connector)	Female connector/socket
Connector (connection type)	for conductor
Mismating protection	No
Plugging without loss of pin spacing	Yes
Locking of plug-in connection	none

## Material Data

Note (material data)	Information on material specifications can be found here
Color	light gray
Material group	I
Insulation material	Polyphthalamide (PPA GF)
Flammability class per UL94	V0
Clamping spring material	Chrome-nickel spring steel (CrNi)
Contact material	Electrolytic copper (E <sub>Cu</sub> )
Contact plating	Tin
Fire load	0.042 MJ
Weight	1.8 g

## Environmental requirements

Limit temperature range	-60 ... +100 °C
Processing temperature	-35 ... +60 °C

Subject to changes. Please also observe the further product documentation!

WAGO GmbH & Co. KG  
 Hansastr. 27  
 32423 Minden  
 Phone: +49571 887-0 | Fax: +49571 887-169  
 Email: [info.de@wago.com](mailto:info.de@wago.com) | Web: [www.wago.com](http://www.wago.com)

Do you have any questions about our products?  
 We are always happy to take your call at +49 (571) 887-44222.

## Commercial data

Product Group	26 (picoMAX Connectors)
eCl@ss 10.0	27-14-11-06
eCl@ss 9.0	27-14-11-06
ETIM 8.0	EC001284
ETIM 7.0	EC001284
PU (SPU)	200 pcs
Packaging type	box
Country of origin	DE
GTIN	4050821163473
Customs tariff number	85366990990

## Environmental Product Compliance

RoHS Compliance Status	Compliant, No Exemption
------------------------	-------------------------

## Approvals / Certificates











### General approvals

Logo	Approval	Additional Approval Text	Certificate name
	<b>CB</b> DEKRA Certification B.V.	IEC 61984	NL-49737 /A1
	<b>CSA</b> DEKRA Certification B.V.	C22.2 No. 158	2362521
	<b>CSA</b> DEKRA Certification B.V.	C22.2	2362521
	<b>cURus</b> Underwriters Laboratories Inc.	UL 1059	E45172
	<b>KEMA/KEUR</b> DEKRA Certification B.V.	EN 61984	71-102261 REV.2
	<b>UL</b> Underwriters Laboratories Inc.	UL 1977	E45171

Subject to changes. Please also observe the further product documentation!



## Counterpart

	<b>Item no.2092-1402</b> THT male header; 1.4 mm Ø solder pin; straight; Pin spacing 5 mm; 2-pole; light gray	<a href="http://www.wago.com/2092-1402">www.wago.com/2092-1402</a>
	<b>Item no.2092-1402/005-000</b> THT male header; 1.4 mm Ø solder pin; straight; clamping collar; Pin spacing 5 mm; 2-pole; light gray	<a href="http://www.wago.com/2092-1402/005-000">www.wago.com/2092-1402/005-000</a>
	<b>Item no.2092-1402/200-000</b> THR male header; 1.4 mm Ø solder pin; straight; Pin spacing 5 mm; 2-pole; light gray	<a href="http://www.wago.com/2092-1402/200-000">www.wago.com/2092-1402/200-000</a>
	<b>Item no.2092-1402/205-000</b> THR male header; 1.4 mm Ø solder pin; straight; clamping collar; Pin spacing 5 mm; 2-pole; light gray	<a href="http://www.wago.com/2092-1402/205-000">www.wago.com/2092-1402/205-000</a>
	<b>Item no.2092-1422</b> THT male header; 1.4 mm Ø solder pin; angled; Pin spacing 5 mm; 2-pole; light gray	<a href="http://www.wago.com/2092-1422">www.wago.com/2092-1422</a>
	<b>Item no.2092-1422/200-000</b> THR male header; 1.4 mm Ø solder pin; angled; Pin spacing 5 mm; 2-pole; light gray	<a href="http://www.wago.com/2092-1422/200-000">www.wago.com/2092-1422/200-000</a>
	<b>Item no.2092-1422/005-000</b> THT male header; 1.4 mm Ø solder pin; angled; clamping collar; Pin spacing 5 mm; 2-pole; light gray	<a href="http://www.wago.com/2092-1422/005-000">www.wago.com/2092-1422/005-000</a>
	<b>Item no.2092-1422/205-000</b> THR male header; 1.4 mm Ø solder pin; angled; clamping collar; Pin spacing 5 mm; 2-pole; light gray	<a href="http://www.wago.com/2092-1422/205-000">www.wago.com/2092-1422/205-000</a>
	<b>Item no.2092-1522/002-000</b> 1-conductor male connector; Push-in CAGE CLAMP®; 2.5 mm <sup>2</sup> ; Pin spacing 5 mm; 2-pole; Integrated release lever; 2,50 mm <sup>2</sup> ; light gray	<a href="http://www.wago.com/2092-1522/002-000">www.wago.com/2092-1522/002-000</a>
	<b>Item no.2092-1632/024-000</b> Panel feedthrough male connector; clamping collar; 2.5 mm <sup>2</sup> ; 2-pole; Pin spacing 5 mm; light gray	<a href="http://www.wago.com/2092-1632/024-000">www.wago.com/2092-1632/024-000</a>
	<b>Item no.2092-1522/020-000</b> 1-conductor male connector; Push-in CAGE CLAMP®; 2.5 mm <sup>2</sup> ; Pin spacing 5 mm; 2-pole; DIN-35 rail/panel mounting; Snap-in mounting feet; Integrated release lever; 2,50 mm <sup>2</sup> ; light gray	<a href="http://www.wago.com/2092-1522/020-000">www.wago.com/2092-1522/020-000</a>

Subject to changes. Please also observe the further product documentation!



**Item no. 2092-1502/002-000**

1-conductor male connector; Push-in CAGE CLAMP®; 2.5 mm<sup>2</sup>; Pin spacing 5 mm; 2-pole; Gripping plate; 2,50 mm<sup>2</sup>; light gray

[www.wago.com](http://www.wago.com)

[/2092-1502/002-000](http://www.wago.com/2092-1502/002-000)



**Item no. 2092-1702/200-000**

THR male header; 1.4 mm Ø solder pin; straight; Pin spacing 5 mm; 2-pole; black

[www.wago.com](http://www.wago.com)

[/2092-1702/200-000](http://www.wago.com/2092-1702/200-000)



**Item no. 2092-1722/200-000**

THR male header; 1.4 mm Ø solder pin; angled; Pin spacing 5 mm; 2-pole; black

[www.wago.com](http://www.wago.com)

[/2092-1722/200-000](http://www.wago.com/2092-1722/200-000)



**Item no. 2092-1722**

THT male header; 1.4 mm Ø solder pin; angled; Pin spacing 5 mm; 2-pole; black

[www.wago.com](http://www.wago.com)

[/2092-1722](http://www.wago.com/2092-1722)



**Item no. 2092-1702**

THT male header; 1.4 mm Ø solder pin; straight; Pin spacing 5 mm; 2-pole; black

[www.wago.com](http://www.wago.com)

[/2092-1702](http://www.wago.com/2092-1702)

## Optional accessories

### Strain relief

#### Strain relief plate



**Item no.: 2092-1600/002-000**

Gripping plate with sliding connector release; for female and male connectors; 2 parts; Pin spacing 5 mm; 2-pole; light gray

[www.wago.com/2092-1600/002-000](http://www.wago.com/2092-1600/002-000)



**Item no.: 2092-1600**

Gripping plate; for female and male connectors; 1 part; Pin spacing 5 mm; 2-pole; light gray

[www.wago.com/2092-1600](http://www.wago.com/2092-1600)

### Tool

#### Operating tool



**Item no.: 2092-1630**

Unlocking tool; orange

[www.wago.com/2092-1630](http://www.wago.com/2092-1630)



**Item no.: 210-719**

Operating tool; Blade: 2.5 x 0.4 mm; with a partially insulated shaft

[www.wago.com/210-719](http://www.wago.com/210-719)

## Testing and measuring

### Testing accessories



**Item no.: 735-500**

WAGO Test pin; 1 mm Ø; 30 V AC / 60 V DC; CAT0; 1 A; 6 mm uninsulated; Test lead for soldering up to 0,5mm<sup>2</sup>

[www.wago.com/735-500](http://www.wago.com/735-500)

## Downloads

### Documentation

#### Additional Information

#### Technical Section

Subject to changes. Please also observe the further product documentation!

WAGO GmbH & Co. KG

Hansastr. 27

32423 Minden

Phone: +49571 887-0 | Fax: +49571 887-169

Email: [info.de@wago.com](mailto:info.de@wago.com) | Web: [www.wago.com](http://www.wago.com)

Do you have any questions about our products?

We are always happy to take your call at +49 (571) 887-44222.

Technical explanations

2019 Apr 3

pdf  
2.0 MB

Download

## CAD/CAE-Data

### CAD data

2D/3D Models 2092-1122

URL

Download

### CAE data

ZUKEN Portal 2092-1122

URL

Download

## Environmental Product Compliance

### Compliance Search

Environmental Product Compliance 2092-1122

URL

Download

1-conductor female connector; push-button; Push-in CAGE CLAMP®; 2.5 mm<sup>2</sup>; Pin spacing 5 mm; 2-pole; 2,50 mm<sup>2</sup>; light gray

## Installation Notes

### Locking system

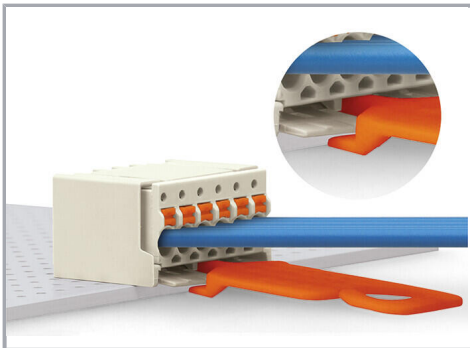

Disconnecting a female connector via unlocking tool. Plug unlocking tool into the male header's locking latch.

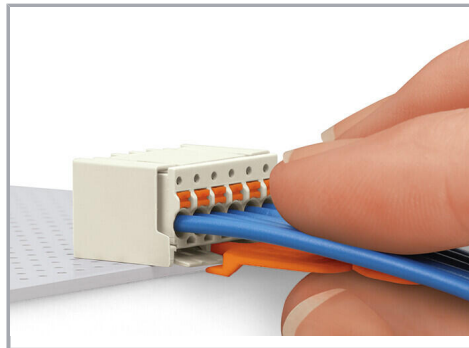

Insert unlocking tool until it hits the backstop. Wedge opens locking latches.

Subject to changes. Please also observe the further product documentation!



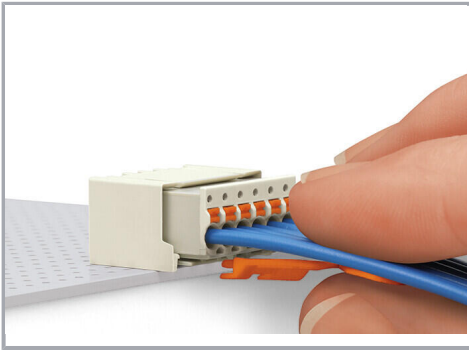

Pull on both unlocking tool and conductors to remove female connector from male header.

### Conductor termination

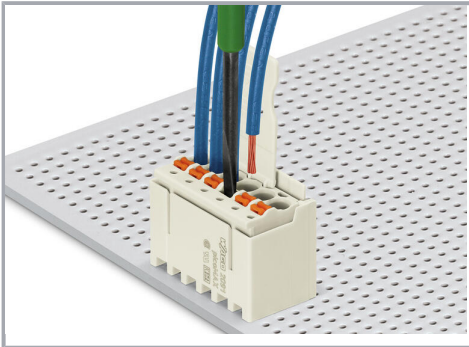

Inserting fine-stranded conductor into mated female connector via push-button.

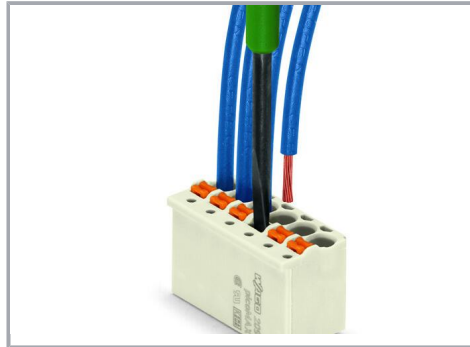

Inserting a fine-stranded conductor into an unmated female connector via push-button.

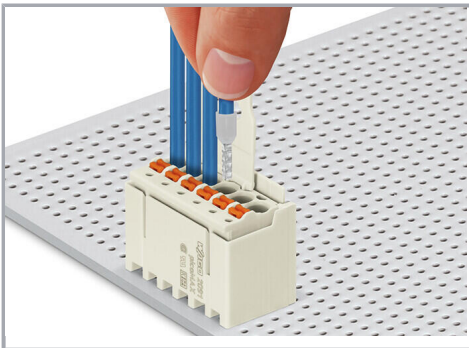

Inserting solid and ferruled conductors via push-in termination.

### Marking

Subject to changes. Please also observe the further product documentation!



Pole marking via factory direct marking.

### Coding

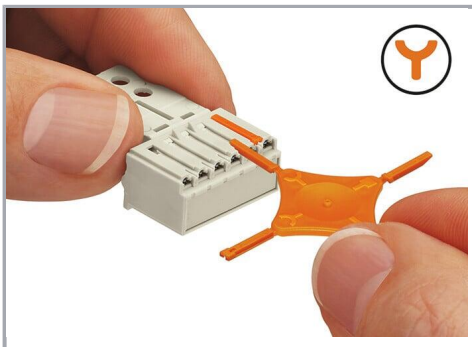

Coding a female connector (via coding key carrier and two keys for female connector, see symbol).

### Testing

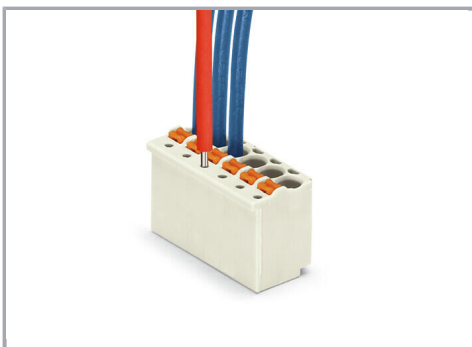

Testing via 1 mm Ø test pin – touch contact.

Subject to changes. Please also observe the further product documentation!